

AXIS-FP

Axial smoke extraction fans

Use

- The fans are used for extraction of smoke in case of fire and removal of hot air outside. The fans are also used for general ventilation systems.
- The fans are rated for permanent operation at ambient air temperatures from -60 °C up to +50 °C (depends on climatic category, see the Designation key). The fans are able to operate 2 hours at the temperatures +300 °C and +400 °C.
- The fans with a fire resistance class of 200 °C/2 hours can be produced on request. The characteristics of the 200 °C/2 hours fans are completely identical to 300 °C/2 hours fans.



Air flow:
up to 125 000 m³/h



Fire resistance rating:
300 °C/2 hours
400 °C/2 hours

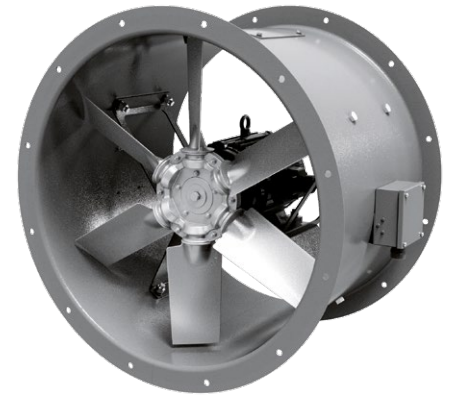

Design

- The fan consists of a casing, an impeller and a motor. The metal casing with rolled flanges helps achieve outstanding rigidity and minimum clearances between the casing and the blades. There is an inspection hatch in the casing for easy maintenance.
- All the casing components are powder coated for improved protection against the environmental effects.
- The weight of the fans may differ from the one stated in the catalogue and depends on the components used (motor, terminal box, etc.).

Motor

- The fans are equipped with three-phase (400 V/60 Hz) motors. Motor ingress protection rating is IP55.
- The motor RPM could be changed insignificantly in accordance with the actual motor datasheet. Consequently, the airflow could be altered respectively as well. Depending on the model, the fans have single- or double-speed modifications.
- The single-speed models are equipped with 2-, 4- or 6-pole motors.
- The double-speed models are equipped with 2/4-, 4/6- or 4/8-pole motors.

Impeller

- Depending on the size and the required air capacity the fans are equipped with impellers with 4, 5, 6, 7, 8, 9 or 12 blades angled from 20° to 50° to ensure precise matching of fans with the operating point.
- The specially designed impeller blades ensure high efficiency of the fan while keeping noise well under control.
- The impellers are dynamically balanced. Low weight and low moment of the impeller inertia help reduce the fan start-up time.
- The fan blades are made of cast aluminium.

Mounting

- The fans can be mounted on any flat surface or directly into a ventilation duct. The units are suitable for both horizontal and vertical configurations.
- Installation in the air duct requires flanges to attach the fan to the ductwork.
- To attach the fan to the floor, the wall or the ceiling use the O-AF carriers (not included as standard, should be purchased separately).
- The fans are suitable for installation on rooftops.

Designation key

Casing
Motor
Impeller
Modification
Frequency

AXIS-FP 630 K - 2 D / 5.5 - 8 / 35 / AL - U 1 - 300/2 60 HZ

Axis-FP: Axial smoke extraction fan	AXIS-FP
Standard size (duct diameter) [mm]	630
Modification: _: standard casing K: shortened casing	K - 2 D
Number of motor poles	5.5
Motor phase: E: single-phase D: three-phase	8 / 35
Motor power [kW]	AL
Number of impeller blades [items]	U 1
Blade setting angle [°]	300/2
Blade material: AL: aluminium	60 HZ
Climatic category: U: moderate climate (-40 ... +40 °C) HL: cold climate (-60 ... +40 °C) UHL: moderate and cold climate (-60 ... +40 °C) T: tropical climate (-10 ... +50 °C) M: maritime moderately cold climate (-40 ... +40 °C) O: general climatic modification (except maritime climate) (-60 ... +50 °C) OM: general maritime climatic modification (-40 ... +40 °C) V: universal climatic modification (-60 ... +50 °C)	
Placement category: 1: outdoors 2: under a shed or indoors with the same conditions as outdoors except solar radiation and precipitation 3: in closed rooms without artificial climate control 4: in closed rooms with artificial climate control (ventilation, heating) 5: in rooms with high levels of humidity, without artificial climate control	
Fire resistance rating: 300/2: 300 °C, 2 hours 400/2: 400 °C, 2 hours	
Frequency: _: 50 Hz 60 Hz: 60 Hz	

Overall dimensions [mm]

Model	∅ D	∅ D1	∅ D2	∅ d	n	W
Axis-FP 400...	400	450	490	8	12	525
Axis-FP 450...	450	500	540	8	12	580
Axis-FP 500...	500	560	600	12	12	620
Axis-FP 560...	560	620	660	12	12	680
Axis-FP 630...	630	690	730	12	12	750
Axis-FP 710...	710	770	810	12	16	845
Axis-FP 800...	800	860	900	12	16	925
Axis-FP 900...	900	970	1015	15	16	1025
Axis-FP 1000...	1000	1070	1115	15	16	1140
Axis-FP 1120...	1120	1190	1270	15	20	1280
Axis-FP 1250...	1250	1320	1400	15	20	1450

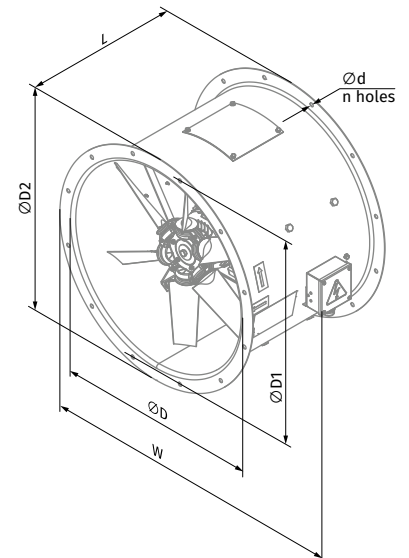

Technical data AXIS-FP...300/2

AXIS-FP 400...300/2

Size	Number of poles	Voltage [V/60 Hz]	Fan model	Installed motor power Ny [kW]	RPM [min ⁻¹]	Number of blades	Blade setting angle [°]	Weight [kg]	Length L [mm]	Curve number on graph
Axis-FP 400-2D...300/2										
400	2	3~400	Axis-FP 400-2D/0.55-3/25/AL	0.55	3456	3	25	25.6	400	①
			Axis-FP 400-2D/0.75-3/30/AL	0.75	3456	3	30	28.7	400	②
			Axis-FP 400-2D/1.1-3/35/AL	1.1	3456	3	35	31.3	400	③
			Axis-FP 400-2D/1.5-3/40/AL	1.5	3456	3	40	32.3	400	④
			Axis-FP 400-2D/2.2-3/45/AL	2.2	3456	3	45	33.3	400	⑤
			Axis-FP 400-2D/2.2-4/45/AL	2.2	3456	4	45	33.4	400	⑥
Axis-FP 400-4D...300/2										
400	4	3~400	Axis-FP 400-4D/0.37-3/30/AL	0.37	1728	3	30	23.6	400	①
			Axis-FP 400-4D/0.37-3/35/AL	0.37	1728	3	35	23.6	400	②
			Axis-FP 400-4D/0.37-3/40/AL	0.37	1728	3	40	23.6	400	③
			Axis-FP 400-4D/0.37-3/45/AL	0.37	1728	3	45	23.6	400	④
			Axis-FP 400-4D/0.37-4/45/AL	0.37	1728	4	45	24	400	⑤

Standard size: 400
Number of poles: 2
Fire resistance rating: 300/2

Standard size: 400
Number of poles: 4
Fire resistance rating: 300/2

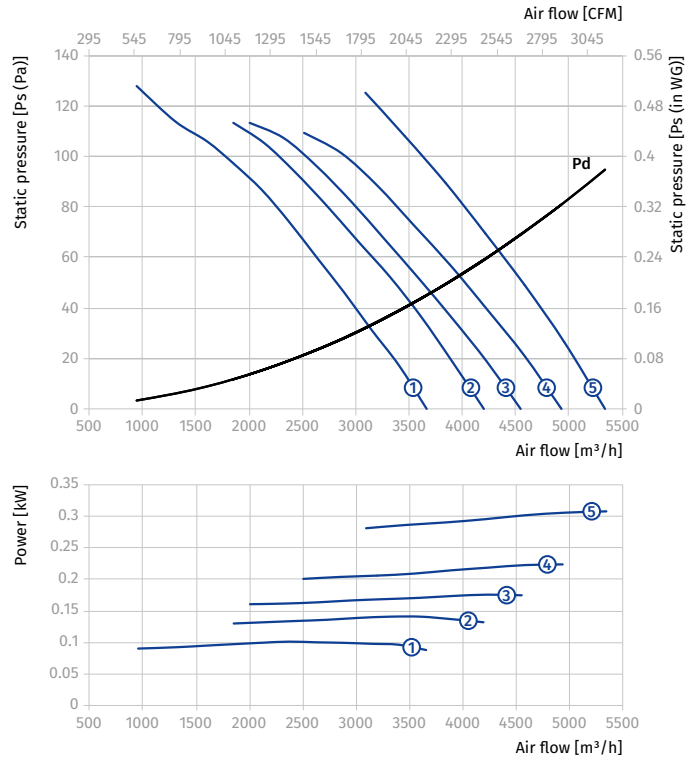
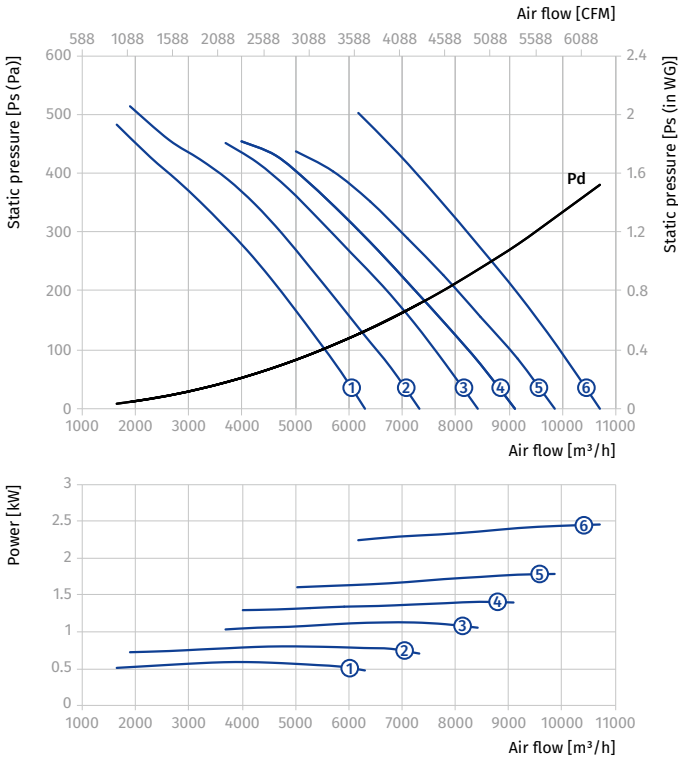

AXIS-FP 400...300/2

Size	Number of poles	Voltage [V/60 Hz]	Fan model	Installed motor power Ny [kW]	RPM [min ⁻¹]	Number of blades	Blade setting angle [°]	Weight [kg]	Length L [mm]	Curve number on graph
Axis-FP 400-2/4D...300/2										
400	2/4	3~400	Axis-FP 400-2/4D/1.1/0.25-3/30/AL	1.1/0.25	3456/1728	3	30	29.7	400	①
			Axis-FP 400-2/4D/1.1/0.25-3/35/AL	1.1/0.25	3456/1728	3	35	29.7	400	②
			Axis-FP 400-2/4D/1.5/0.37-3/40/AL	1.5/0.37	3456/1728	3	40	35.3	400	③
			Axis-FP 400-2/4D/2.5/0.65-3/45/AL	2.5/0.65	3456/1728	3	45	48.5	500	④
			Axis-FP 400-2/4D/2.5/0.65-4/45/AL	2.5/0.65	3456/1728	4	45	48.5	500	⑤

Standard size: 400
 Number of poles: 2
 Fire resistance rating: 300/2

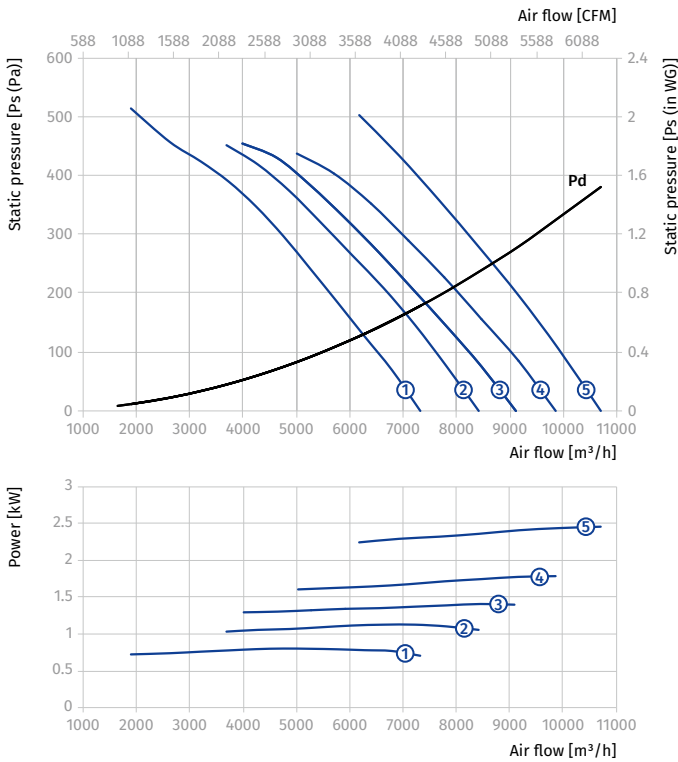

Standard size: 400
 Number of poles: 4
 Fire resistance rating: 300/2

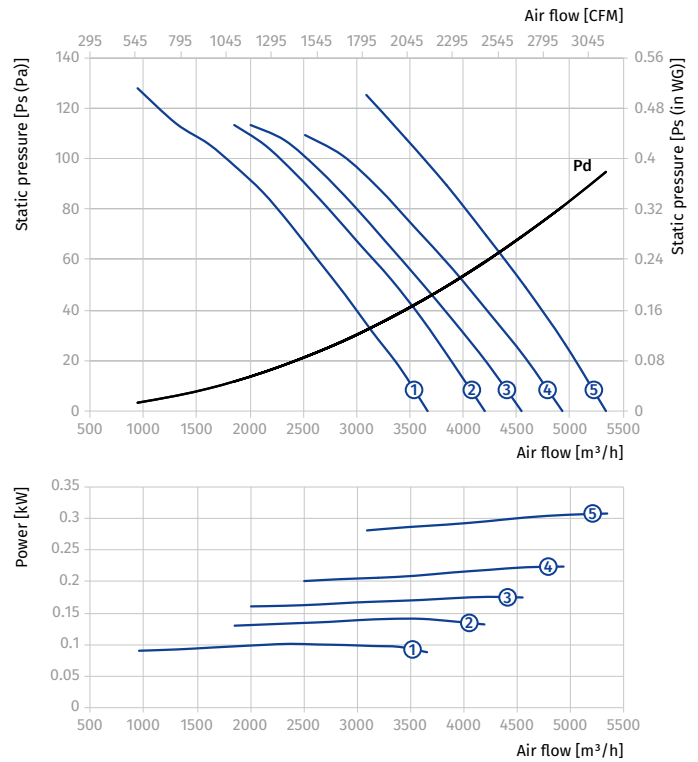

AXIS-FP 450...300/2

Size	Number of poles	Voltage [V/60 Hz]	Fan model	Installed motor power Ny [kW]	RPM [min ⁻¹]	Number of blades	Blade setting angle [°]	Weight [kg]	Length L [mm]	Curve number on graph
Axis-FP 450-2D...300/2										
450	2	3~400	Axis-FP 450-2D/0.75-3/25/AL	0.75	3456	3	25	30.2	400	①
			Axis-FP 450-2D/1.1-3/30/AL	1.1	3456	3	30	32.8	400	②
			Axis-FP 450-2D/1.5-3/35/AL	1.5	3456	3	35	33.8	400	③
			Axis-FP 450-2D/2.2-3/40/AL	2.2	3456	3	40	34.8	400	④
			Axis-FP 450-2D/3-4/40/AL	3	3456	4	40	40	400	⑤
			Axis-FP 450-2D/3.7-4/45/AL	3.7	3456	4	45	52.3	500	⑥
Axis-FP 450-4D...300/2										
450	4	3~400	Axis-FP 450-4D/0.37-3/25/AL	0.37	1728	3	25	25.1	400	①
			Axis-FP 450-4D/0.37-3/30/AL	0.37	1728	3	30	25.1	400	②
			Axis-FP 450-4D/0.37-3/35/AL	0.37	1728	3	35	25.1	400	③
			Axis-FP 450-4D/0.37-3/40/AL	0.37	1728	3	40	25.1	400	④
			Axis-FP 450-4D/0.37-4/40/AL	0.37	1728	4	40	25.4	400	⑤
			Axis-FP 450-4D/0.55-4/45/AL	0.55	1728	4	45	26.4	400	⑥

Standard size: 450
Number of poles: 2
Fire resistance rating: 300/2

Standard size: 450
Number of poles: 4
Fire resistance rating: 300/2

AXIAL SMOKE EXTRACTION FANS

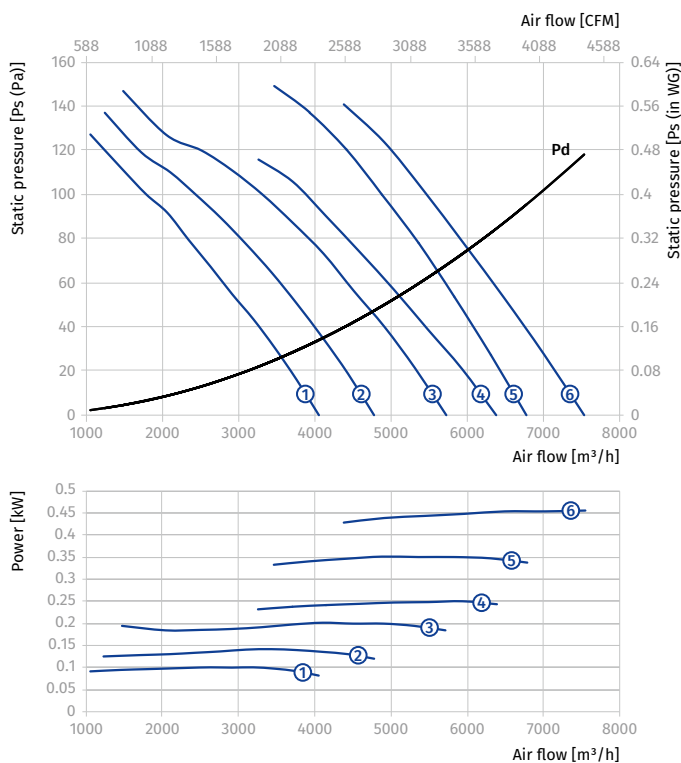
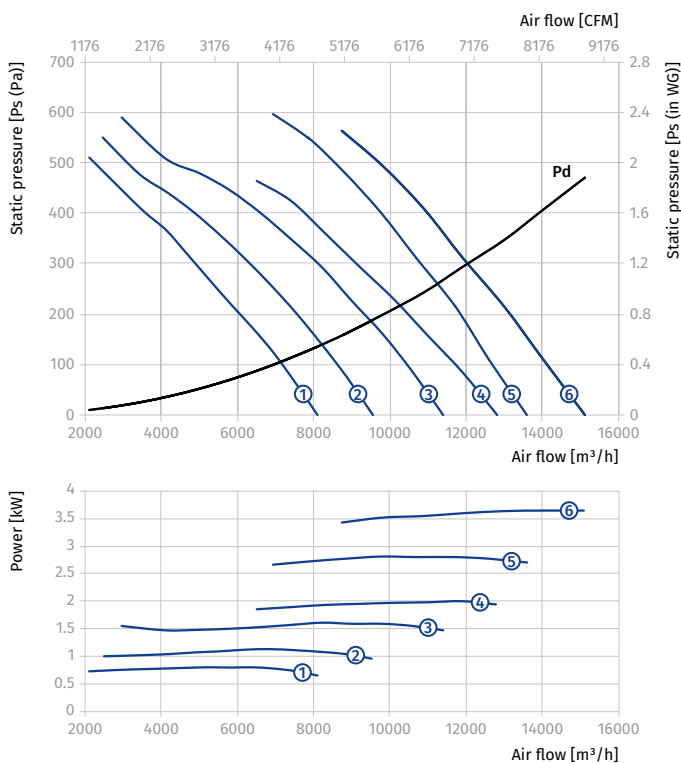

AXIS-FP 450...300/2

Size	Number of poles	Voltage [V/60 Hz]	Fan model	Installed motor power N_y [kW]	RPM [min^{-1}]	Number of blades	Blade setting angle [°]	Weight [kg]	Length L [mm]	Curve number on graph
Axis-FP 450-2/4D...300/2										
400	2/4	3~400	Axis-FP 450-2/4D/1.1/0.25-3/25/AL	1.1/0.25	3456/1728	3	25	31.2	400	①
			Axis-FP 450-2/4D/1.1/0.25-3/30/AL	1.1/0.25	3456/1728	3	30	31.2	400	②
			Axis-FP 450-2/4D/1.5/0.37-3/35/AL	1.5/0.37	3456/1728	3	35	36.8	400	③
			Axis-FP 450-2/4D/2.5/0.65-3/40/AL	2.5/0.65	3456/1728	3	40	50.2	500	④
			Axis-FP 450-2/4D/3.1/0.8-4/40/AL	3.1/0.8	3456/1728	4	40	51.3	500	⑤
			Axis-FP 450-2/4D/4.4/1.1-4/45/AL	4.4/1.1	3456/1728	4	45	63.2	500	⑥

Standard size: 450
 Number of poles: 2
 Fire resistance rating: 300/2

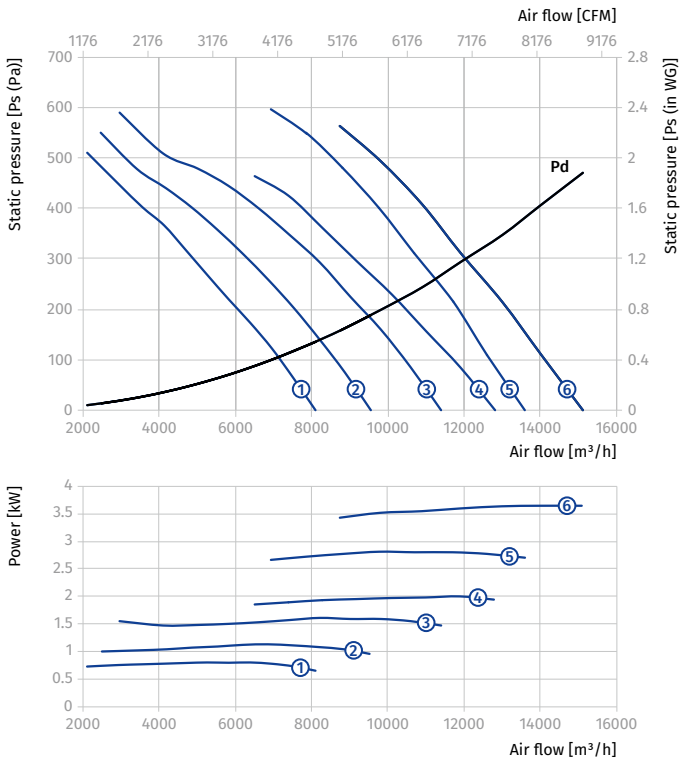

Standard size: 450
 Number of poles: 4
 Fire resistance rating: 300/2

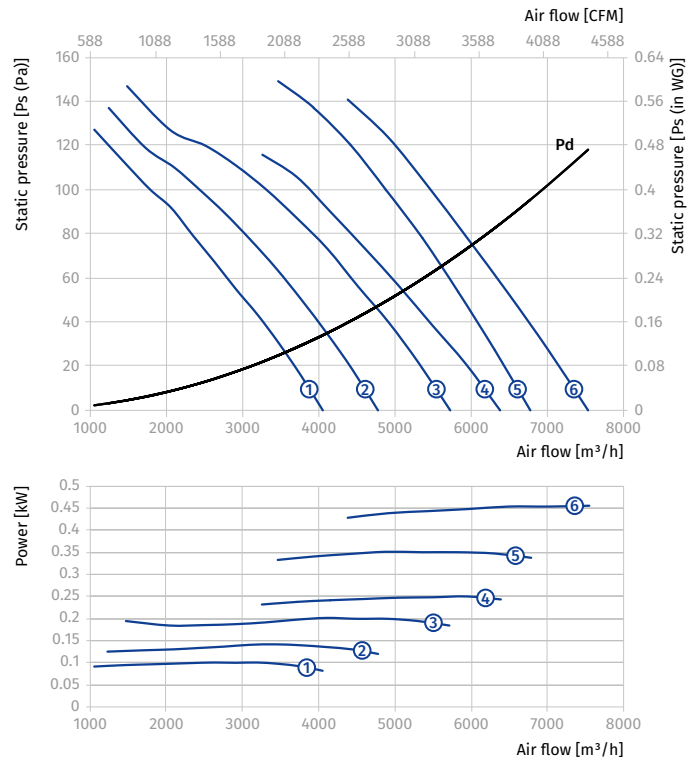

AXIS-FP 500...300/2

Size	Number of poles	Voltage [V/60 Hz]	Fan model	Installed motor power Ny [kW]	RPM [min ⁻¹]	Number of blades	Blade setting angle [°]	Weight [kg]	Length L [mm]	Curve number on graph
Axis-FP 500-2D...300/2										
500	2	3~400	Axis-FP 500-2D/1.1-3/21.5/AL	1.1	3456	3	21.5	36	400	①
			Axis-FP 500-2D/1.5-3/25/AL	1.5	3456	3	25	37	400	②
			Axis-FP 500-2D/2.2-3/30/AL	2.2	3456	3	30	38	400	③
			Axis-FP 500-2D/3-5/31.5/AL	3	3456	5	31.5	42.5	400	④
			Axis-FP 500-2D/3.7-5/35/AL	3.7	3456	5	35	55.5	500	⑤
			Axis-FP 500-2D/4.5-5/40/AL	4.5	3456	5	40	60.5	500	⑥
Axis-FP 500-4D...300/2										
500	4	3~400	Axis-FP 500-4D/0.37-3/25/AL	0.37	1728	3	25	27	400	①
			Axis-FP 500-4D/0.37-3/30/AL	0.37	1728	3	30	27	400	②
			Axis-FP 500-4D/0.37-3/35/AL	0.37	1728	3	35	27	400	③
			Axis-FP 500-4D/0.37-3/40/AL	0.37	1728	3	40	27	400	④
			Axis-FP 500-4D/0.55-3/45/AL	0.55	1728	3	45	28	400	⑤
			Axis-FP 500-4D/0.75-4/45/AL	0.75	1728	4	45	32	400	⑥

Standard size: 500
Number of poles: 2
Fire resistance rating: 300/2

Standard size: 500
Number of poles: 4
Fire resistance rating: 300/2

AXIAL SMOKE EXTRACTION FANS

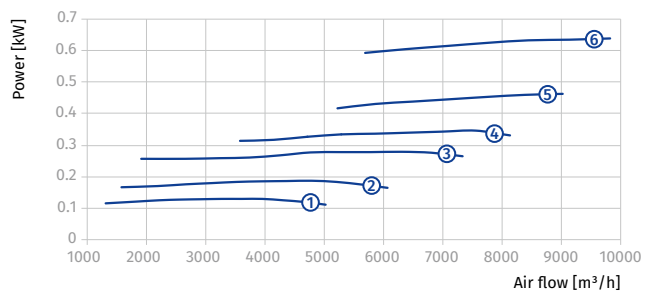
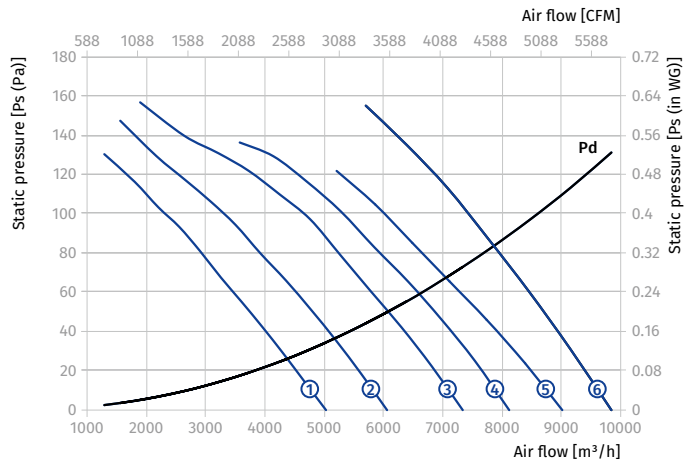
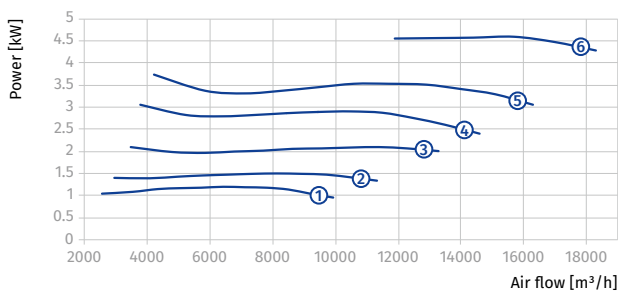
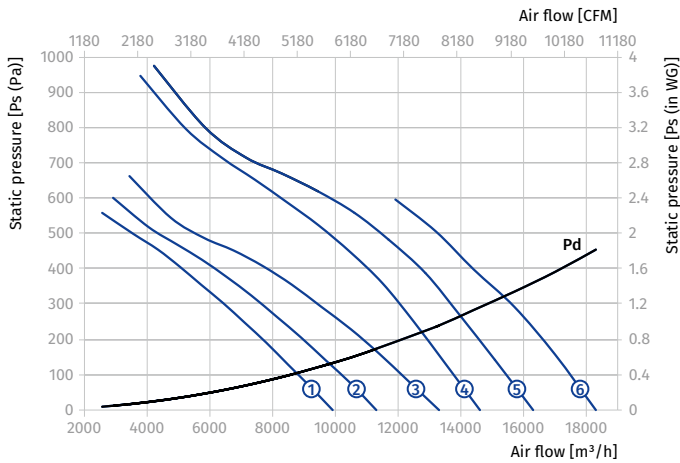

AXIS-FP 500...300/2

Size	Number of poles	Voltage [V/60 Hz]	Fan model	Installed motor power Ny [kW]	RPM [min ⁻¹]	Number of blades	Blade setting angle [°]	Weight [kg]	Length L [mm]	Curve number on graph
Axis-FP 500-2/4D...300/2										
500	2/4	3~400	Axis-FP 500-2/4D/1.1/0.25-3/21.5/AL	1.1/0.25	3456/1728	3	21.5	34.5	400	①
			Axis-FP 500-2/4D/1.5/0.37-3/25/AL	1.5/0.37	3456/1728	3	25	40	400	②
			Axis-FP 500-2/4D/2.5/0.65-3/30/AL	2.5/0.65	3456/1728	3	30	54	500	③
			Axis-FP 500-2/4D/3.1/0.8-5/31.5/AL	3.1/0.8	3456/1728	5	31.5	54.5	500	④
			Axis-FP 500-2/4D/4.4/1.1-5/35/AL	4.4/1.1	3456/1728	5	35	66.5	500	⑤
			Axis-FP 500-2/4D/4.4/1.1-5/40/AL	4.4/1.1	3456/1728	5	40	66.5	500	⑥

Standard size: 500
 Number of poles: 2
 Fire resistance rating: 300/2

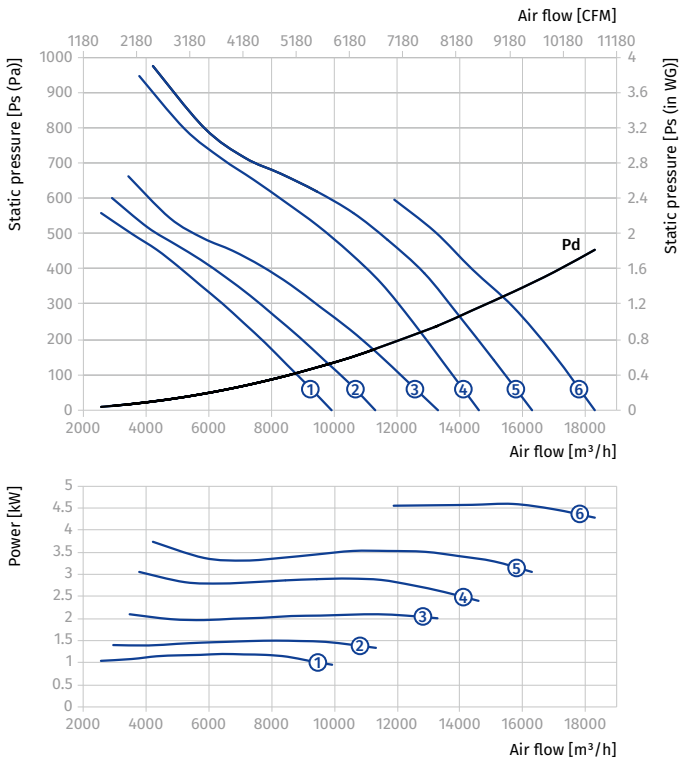

Standard size: 500
 Number of poles: 4
 Fire resistance rating: 300/2

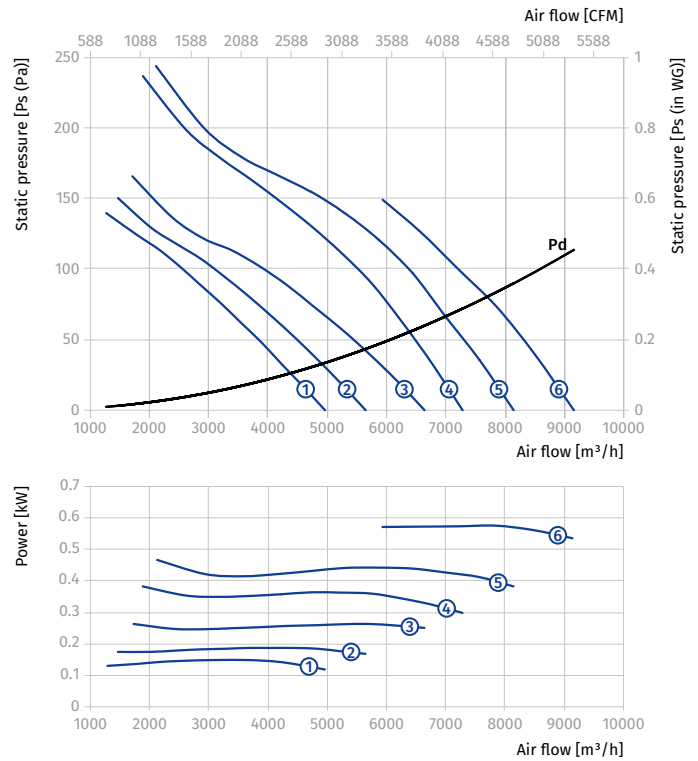

AXIS-FP 560...300/2

Size	Number of poles	Voltage [V/60 Hz]	Fan model	Installed motor power Ny [kW]	RPM [min ⁻¹]	Number of blades	Blade setting angle [°]	Weight [kg]	Length L [mm]	Curve number on graph
Axis-FP 560-2D...300/2										
560	2	3~400	Axis-FP 560-2D/2.2-5/25/AL	2.2	3456	5	25	39.5	400	①
			Axis-FP 560-2D/3-5/28.5/AL	3	3456	5	28.5	44.5	400	②
			Axis-FP 560-2D/3.7-5/32.5/AL	3.7	3456	5	32.5	57.5	500	③
			Axis-FP 560-2D/4.5-5/35/AL	4.5	3456	5	35	62.5	500	④
			Axis-FP 560-2D/5.5-5/38.5/AL	5.5	3456	5	38.5	85.5	550	⑤
			Axis-FP 560-2D/7.5-5/43.5/AL	7.5	3456	5	43.5	102.5	550	⑥
Axis-FP 560-4D...300/2										
560	4	3~400	Axis-FP 560-4D/0.37-3/25/AL	0.37	1728	3	25	29	400	①
			Axis-FP 560-4D/0.37-3/30/AL	0.37	1728	3	30	29	400	②
			Axis-FP 560-4D/0.37-3/35/AL	0.37	1728	3	35	29	400	③
			Axis-FP 560-4D/0.55-3/40/AL	0.55	1728	3	40	30	400	④
			Axis-FP 560-4D/0.75-3/45/AL	0.75	1728	3	45	33.5	400	⑤
			Axis-FP 560-4D/1.1-4/45/AL	1.1	1728	4	45	34.5	400	⑥

Standard size: 560
Number of poles: 2
Fire resistance rating: 300/2

Standard size: 560
Number of poles: 4
Fire resistance rating: 300/2

AXIAL SMOKE EXTRACTION FANS

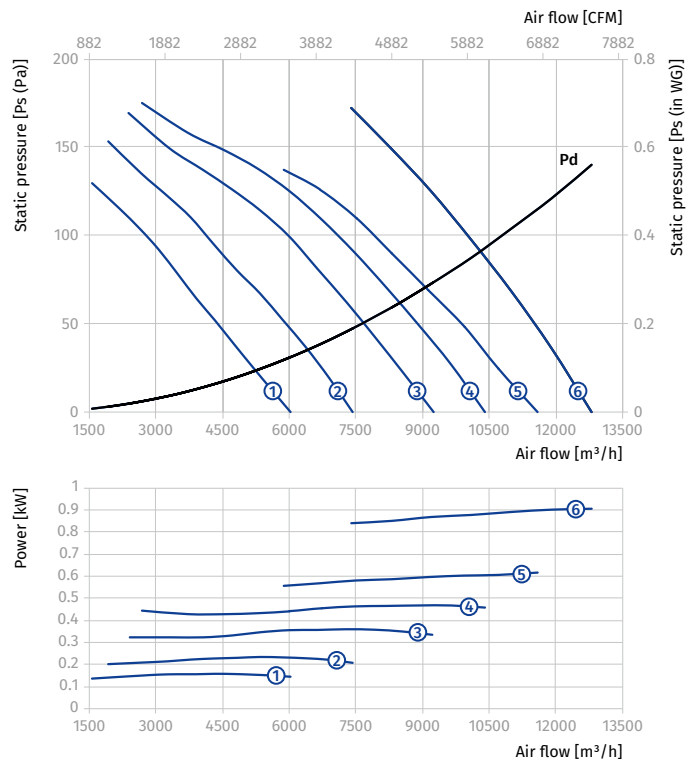
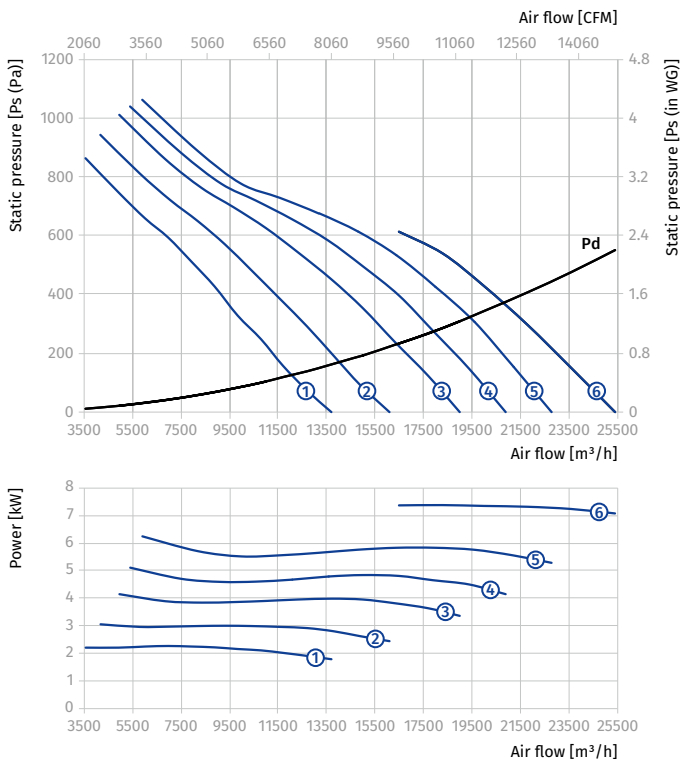

AXIS-FP 560...300/2

Size	Number of poles	Voltage [V/60 Hz]	Fan model	Installed motor power N_y [kW]	RPM [min^{-1}]	Number of blades	Blade setting angle [°]	Weight [kg]	Length L [mm]	Curve number on graph
Axis-FP 560-2/4D...300/2										
560	2/4	3~400	Axis-FP 560-2/4D/2.5/0.65-5/25/AL	2.5/0.65	3456/1728	5	25	55.5	500	①
			Axis-FP 560-2/4D/3.1/0.8-5/28.5/AL	3.1/0.8	3456/1728	5	28.5	56.5	500	②
			Axis-FP 560-2/4D/4.4/1.1-5/32.5/AL	4.4/1.1	3456/1728	5	32.5	68.5	500	③
			Axis-FP 560-2/4D/4.4/1.1-5/35/AL	4.4/1.1	3456/1728	5	35	68.5	500	④
			Axis-FP 560-2/4D/6/1.5-5/38.5/AL	6/1.5	3456/1728	5	38.5	96.5	550	⑤
			Axis-FP 560-2/4D/8/2-5/43.5/AL	8/2	3456/1728	5	43.5	108.5	550	⑥

Standard size: 560
 Number of poles: 2
 Fire resistance rating: 300/2

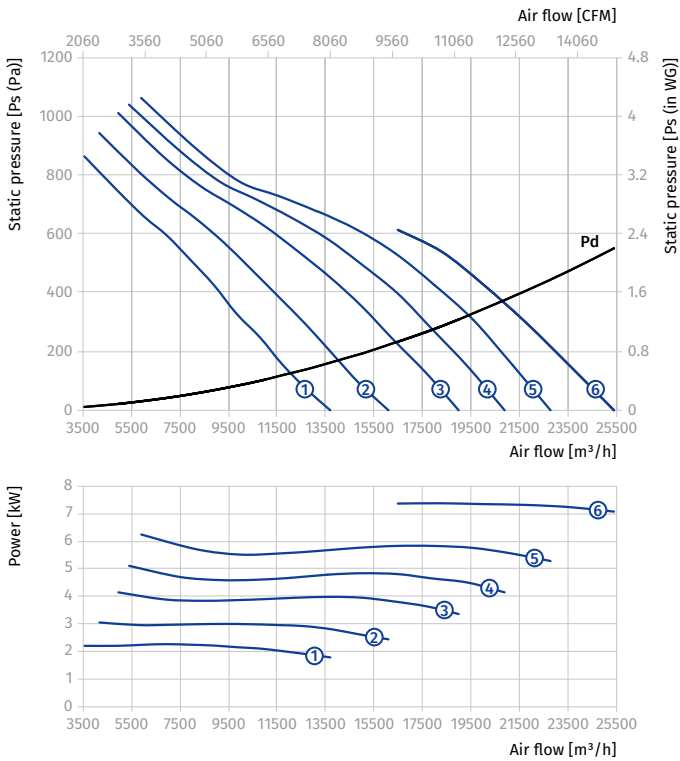

Standard size: 560
 Number of poles: 4
 Fire resistance rating: 300/2

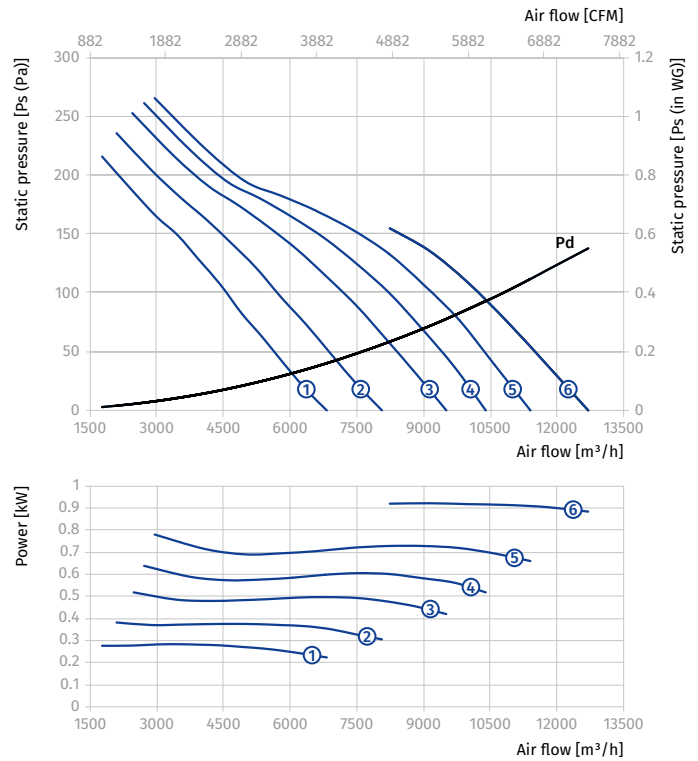

AXIS-FP 630...300/2

Size	Number of poles	Voltage [V/60 Hz]	Fan model	Installed motor power Ny [kW]	RPM [min ⁻¹]	Number of blades	Blade setting angle [°]	Weight [kg]	Length L [mm]	Curve number on graph
Axis-FP 630-2D...300/2										
630	2	3~400	Axis-FP 630-2D/2.2-5/25/AL	2.2	3456	5	25	41.5	400	①
			Axis-FP 630-2D/3.7-5/28.5/AL	3.7	3456	5	28.5	60	500	②
			Axis-FP 630-2D/4.5-5/31.5/AL	4.5	3456	5	31.5	65	500	③
			Axis-FP 630-2D/5.5-5/35/AL	5.5	3456	5	35	89.5	550	④
			Axis-FP 630-2D/7.5-5/38.5/AL	7.5	3456	5	38.5	106.5	550	⑤
			Axis-FP 630-2D/9.2-7/36/AL	9.2	3456	7	36	114	550	⑥
			Axis-FP 630-2D/11-7/38.5/AL	11	3456	7	38.5	116	550	⑦
			Axis-FP 630-2D/15-7/41/AL	15	3456	7	41	161.5	700	⑧
			Axis-FP 630-2D/15-7/43.5/AL	15	3456	7	43.5	161.5	700	⑨
			Axis-FP 630-2D/18.5-7/46.5/AL	18.5	3456	7	46.5	169.5	700	⑩
			Axis-FP 630-2D/18.5-7/48.5/AL	18.5	3456	7	48.5	169.5	700	⑪

Standard size: **630**
Number of poles: **2**
Fire resistance rating: **300/2**

Standard size: **630**
Number of poles: **2**
Fire resistance rating: **300/2**

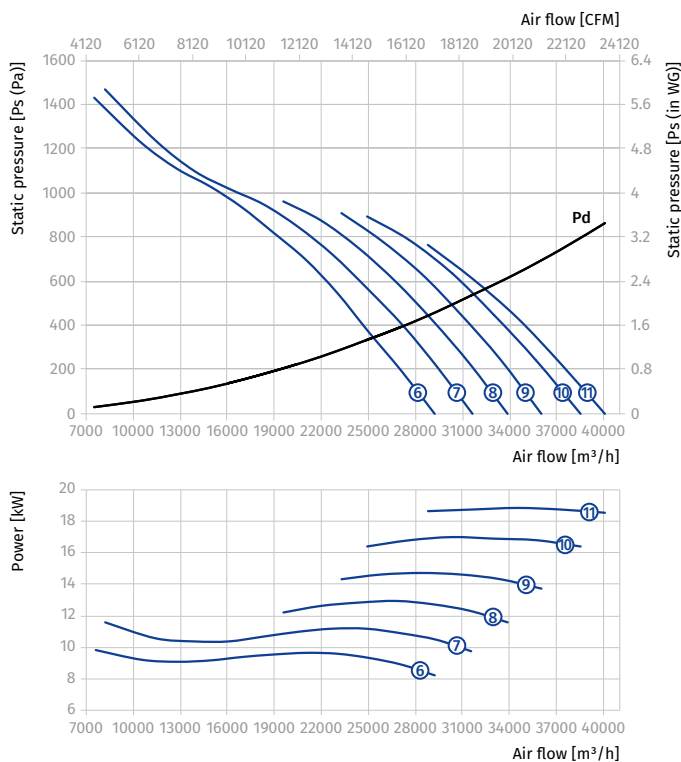
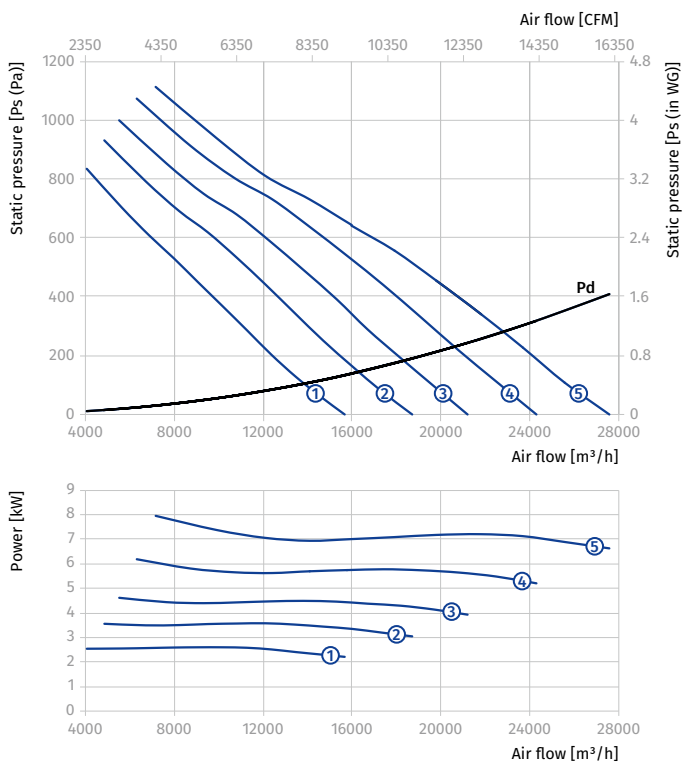

AXIS-FP 630...300/2

Size	Number of poles	Voltage [V/60 Hz]	Fan model	Installed motor power N_y [kW]	RPM [min^{-1}]	Number of blades	Blade setting angle [°]	Weight [kg]	Length L [mm]	Curve number on graph
Axis-FP 630-4D...300/2										
630	4	3~400	Axis-FP 630-4D/0.37-4/25/AL	0.37	1728	4	25	31	400	①
			Axis-FP 630-4D/0.55-4/30/AL	0.55	1728	4	30	32	400	②
			Axis-FP 630-4D/0.75-4/35/AL	0.75	1728	4	35	35.5	400	③
			Axis-FP 630-4D/1.1-4/40/AL	1.1	1728	4	40	36	400	④
			Axis-FP 630-4D/1.1-3/32.5/AL	1.1	1728	3	32.5	38	400	⑤
			Axis-FP 630-4D/1.5-3/37.5/AL	1.5	1728	3	37.5	43	400	⑥
			Axis-FP 630-4D/2.2-3/45/AL	2.2	1728	3	45	46.5	400	⑦

Standard size: 630
 Number of poles: 4
 Fire resistance rating: 300/2

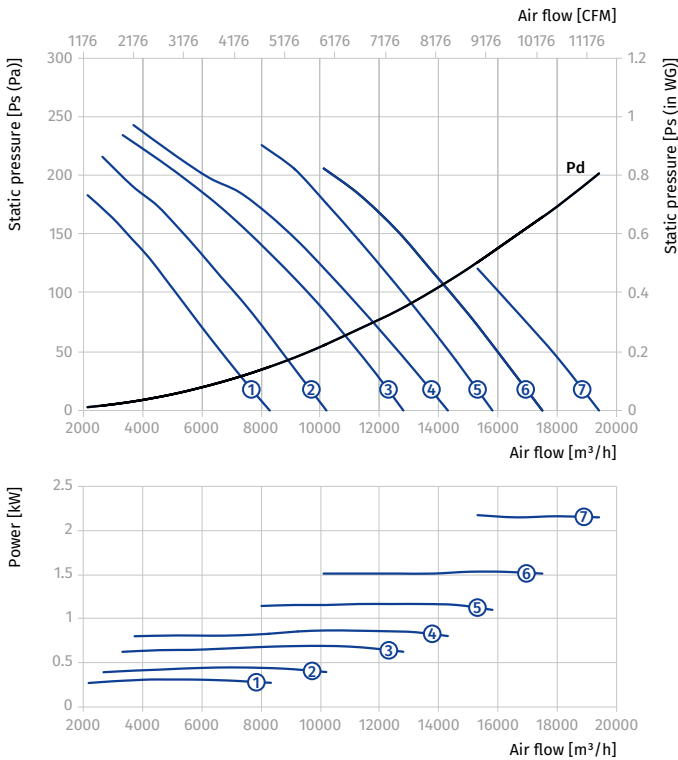

AXIAL SMOKE EXTRACTION FANS

AXIS-FP 630...300/2

Size	Number of poles	Voltage [V/60 Hz]	Fan model	Installed motor power Ny [kW]	RPM [min ⁻¹]	Number of blades	Blade setting angle [°]	Weight [kg]	Length L [mm]	Curve number on graph
Axis-FP 630-2/4D...300/2										
630	2/4	3~400	Axis-FP 630-2/4D/2.5/0.65-5/25/AL	2.5/0.65	3456/1728	5	25	58	500	①
			Axis-FP 630-2/4D/4.4/1.1-5/28.5/AL	4.4/1.1	3456/1728	5	28.5	71	500	②
			Axis-FP 630-2/4D/4.4/1.1-5/31.5/AL	4.4/1.1	3456/1728	5	31.5	71	500	③
			Axis-FP 630-2/4D/6/1.5-5/35/AL	6/1.5	3456/1728	5	35	100.5	550	④
			Axis-FP 630-2/4D/8/2-5/38.5/AL	8/2	3456/1728	5	38.5	112.5	550	⑤

Standard size: **630**
Number of poles: **2**
Fire resistance rating: **300/2**

Standard size: **630**
Number of poles: **4**
Fire resistance rating: **300/2**

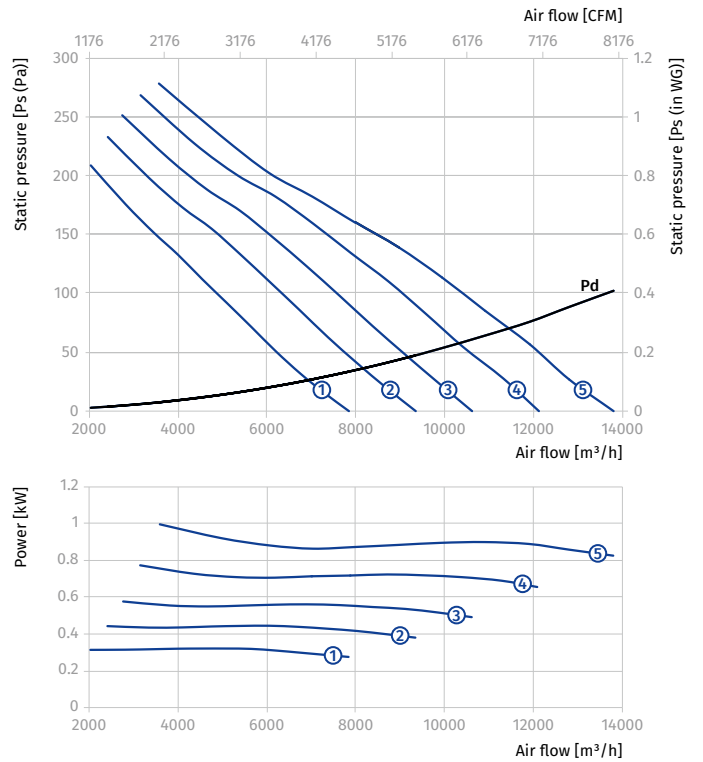
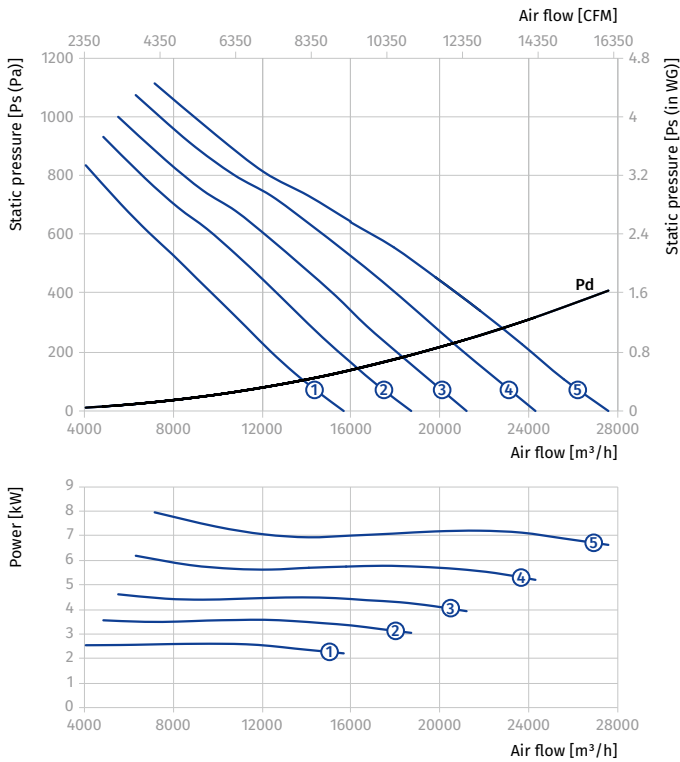

AXIS-FP 630...300/2

Size	Number of poles	Voltage [V/60 Hz]	Fan model	Installed motor power N_y [kW]	RPM [min^{-1}]	Number of blades	Blade setting angle [°]	Weight [kg]	Length L [mm]	Curve number on graph
Axis-FP 630-2/4D...300/2										
630	2/4	3~400	Axis-FP 630-2/4D/12/3-7/38.5/AL	12/3	3456/1728	7	38.5	176.5	700	①
			Axis-FP 630-2/4D/16/4-7/43.5/AL	16/4	3456/1728	7	43.5	192.5	700	②
			Axis-FP 630-2/4D/16/4-7/46.5/AL	16/4	3456/1728	7	46.5	192.5	700	③
			Axis-FP 630-2/4D/20/5.5-7/48.5/AL	20/5.5	3456/1728	7	48.5	221.5	750	④

Standard size: 630
 Number of poles: 2
 Fire resistance rating: 300/2

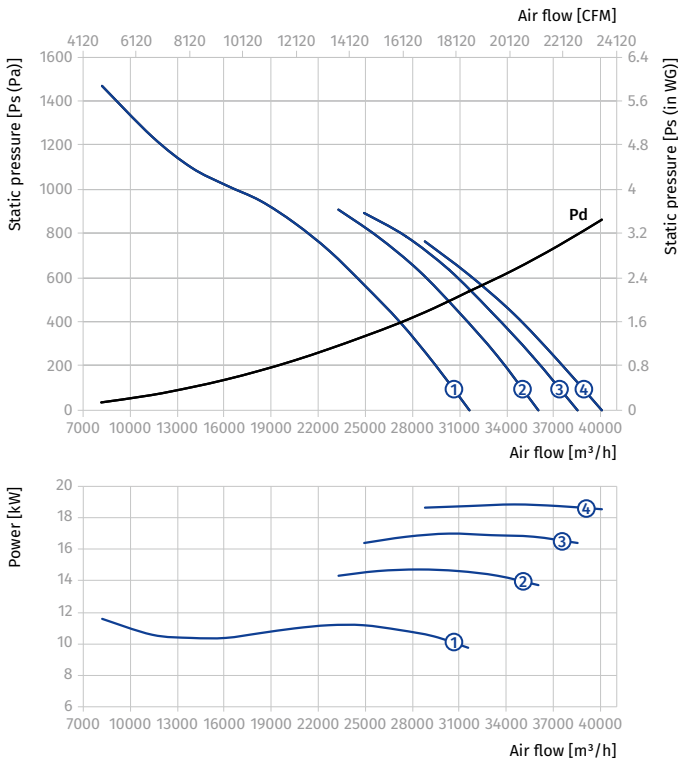

Standard size: 630
 Number of poles: 4
 Fire resistance rating: 300/2

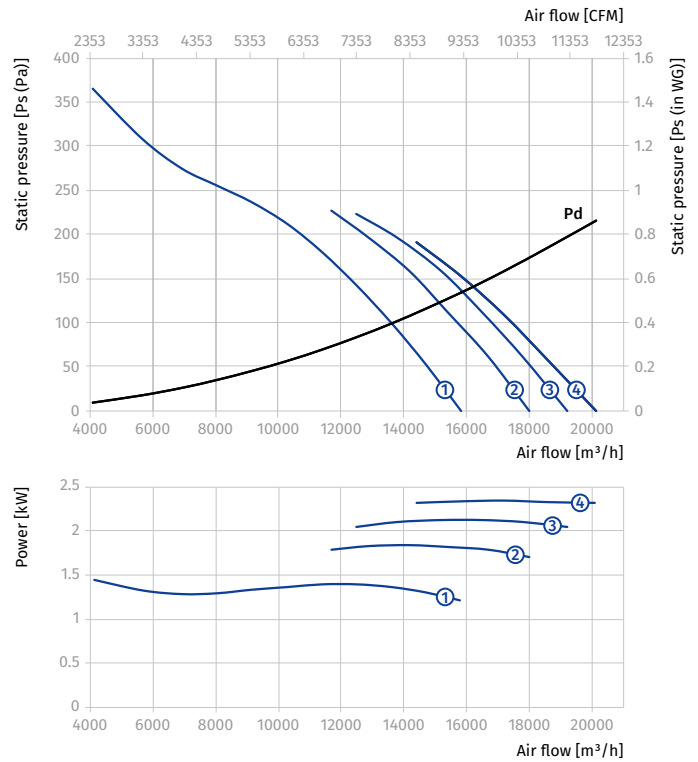

AXIAL SMOKE EXTRACTION FANS

AXIS-FP 630...300/2

Size	Number of poles	Voltage [V/60 Hz]	Fan model	Installed motor power Ny [kW]	RPM [min ⁻¹]	Number of blades	Blade setting angle [°]	Weight [kg]	Length L [mm]	Curve number on graph
Axis-FP 630-4/6D...300/2										
630	4/6	3~400	Axis-FP 630-4/6D/0.55/0.2-4/25/AL	0.55/0.2	1728/1152	4	25	46	400	①
			Axis-FP 630-4/6D/0.55/0.2-4/30/AL	0.55/0.2	1728/1152	4	30	46	400	②
			Axis-FP 630-4/6D/1.1/0.3-4/40/AL	1.1/0.3	1728/1152	4	40	40	400	③
			Axis-FP 630-4/6D/1.1/0.3-3/32.5/AL	1.1/0.3	1728/1152	3	32.5	41.5	400	④
			Axis-FP 630-4/6D/1.5/0.37-3/37.5/AL	1.5/0.37	1728/1152	3	37.5	45.5	400	⑤
			Axis-FP 630-4/6D/3/1-4/45/AL	3/1	1728/1152	4	45	67.5	500	⑥

Standard size: 630
Number of poles: 4
Fire resistance rating: 300/2

Standard size: 630
Number of poles: 6
Fire resistance rating: 300/2

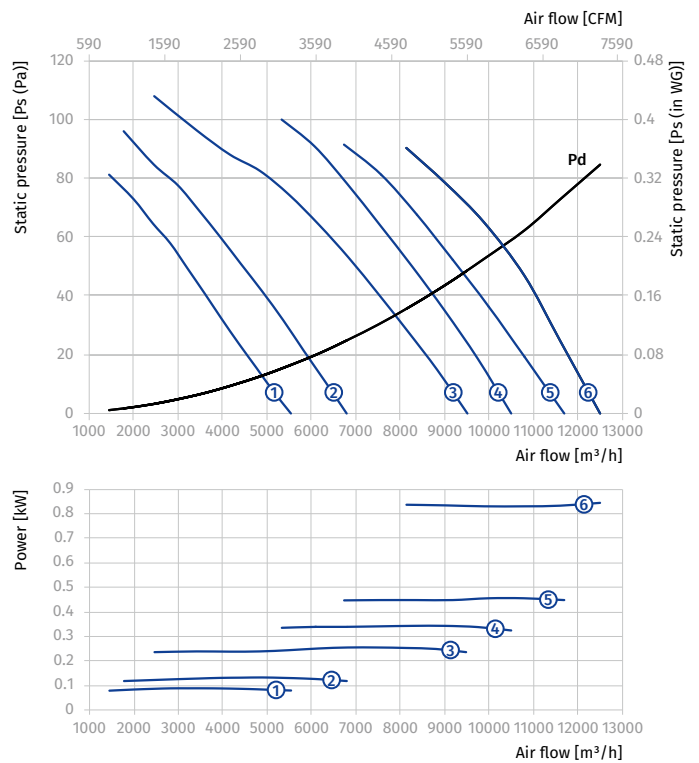
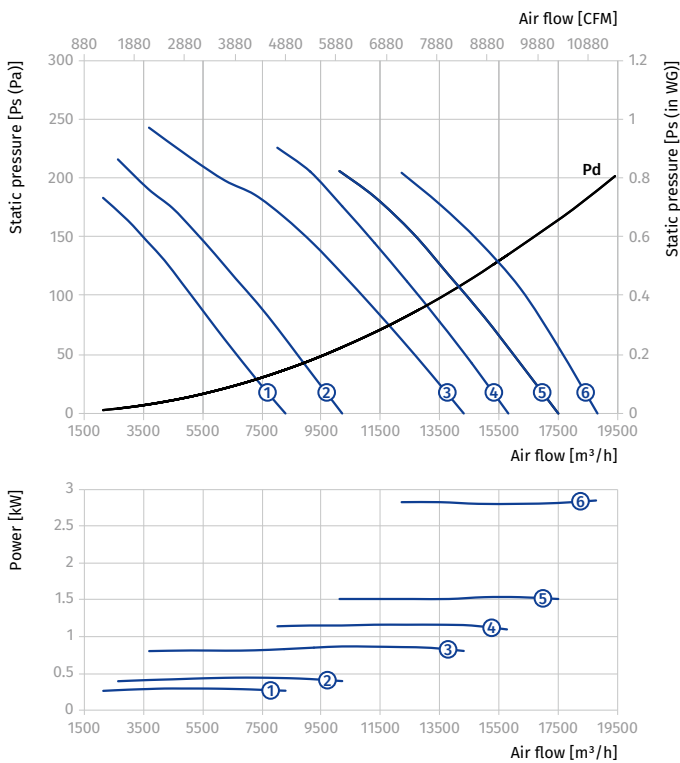

AXIS-FP 630...300/2

Size	Number of poles	Voltage [V/60 Hz]	Fan model	Installed motor power N_y [kW]	RPM [min^{-1}]	Number of blades	Blade setting angle [°]	Weight [kg]	Length L [mm]	Curve number on graph
Axis-FP 630-4/8D...300/2										
630	4/8	3~400	Axis-FP 630-4/8D/0.6/0.15-4/25/AL	0.6/0.15	1728/864	4	25	46	400	①
			Axis-FP 630-4/8D/0.6/0.15-4/30/AL	0.6/0.15	1728/864	4	30	46	400	②
			Axis-FP 630-4/8D/0.8/0.2-4/35/AL	0.8/0.2	1728/864	4	35	46	400	③
			Axis-FP 630-4/8D/1.2/0.3-4/40/AL	1.2/0.3	1728/864	4	40	44	400	④
			Axis-FP 630-4/8D/1.2/0.3-3/32.5/AL	1.2/0.3	1728/864	3	32.5	45.5	400	⑤
			Axis-FP 630-4/8D/1.6/0.4-3/37.5/AL	1.6/0.4	1728/864	3	37.5	48.5	400	⑥
			Axis-FP 630-4/8D/2.2/0.55-3/45/AL	2.2/0.55	1728/864	3	45	60	500	⑦

Standard size: 630
 Number of poles: 4
 Fire resistance rating: 300/2

Standard size: 630
 Number of poles: 8
 Fire resistance rating: 300/2

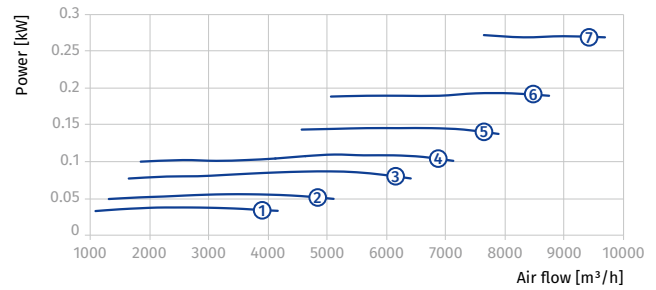
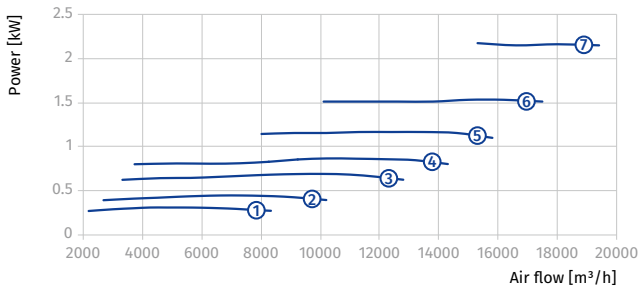
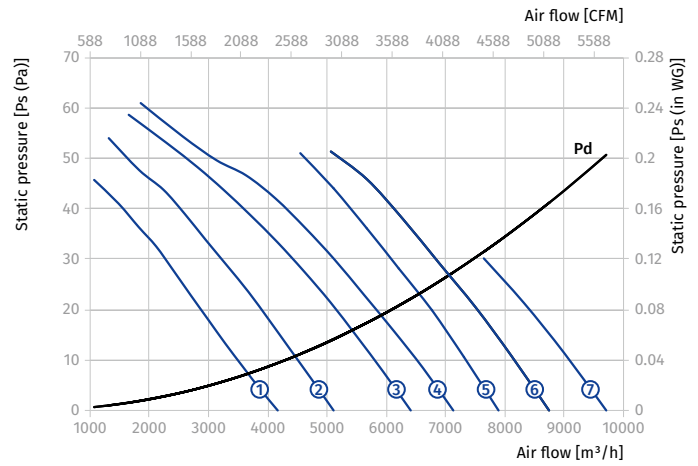
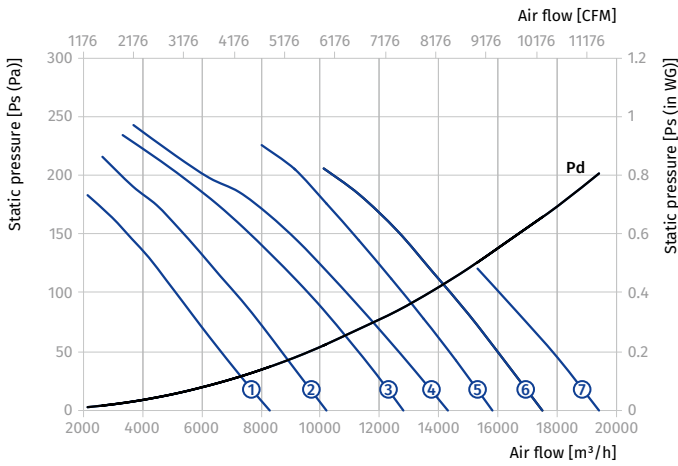

AXIAL SMOKE EXTRACTION FANS

AXIS-FP 710...300/2

Size	Number of poles	Voltage [V/60 Hz]	Fan model	Installed motor power Ny [kW]	RPM [min ⁻¹]	Number of blades	Blade setting angle [°]	Weight [kg]	Length L [mm]	Curve number on graph
Axis-FP 710-4D...300/2										
710	4	3~400	Axis-FP 710-4D/0.75-4/16.5/AL	0.75	1728	4	16.5	51	400	①
			Axis-FP 710-4D/1.1-4/20/AL	1.1	1728	4	20	51.5	400	②
			Axis-FP 710-4D/1.5-4/25/AL	1.5	1728	4	25	57	400	③
			Axis-FP 710-4D/2.2-4/30/AL	2.2	1728	4	30	60.5	400	④
			Axis-FP 710-4D/3-4/35/AL	3	1728	4	35	78.5	500	⑤
			Axis-FP 710-4D/3.7-4/40/AL	3.7	1728	4	40	78.5	500	⑥
Axis-FP 710-6D...300/2										
710	6	3~400	Axis-FP 710-6D/0.25-4/16.5/AL	0.25	1152	4	16.5	46.5	400	①
			Axis-FP 710-6D/0.37-4/20/AL	0.37	1152	4	20	49	400	②
			Axis-FP 710-6D/0.55-4/25/AL	0.55	1152	4	25	53	400	③
			Axis-FP 710-6D/0.55-4/30/AL	0.55	1152	4	30	53	400	④
			Axis-FP 710-6D/0.75-4/35/AL	0.75	1152	4	35	56	400	⑤
			Axis-FP 710-6D/1.1-4/40/AL	1.1	1152	4	40	57.5	400	⑥

Standard size: 710
Number of poles: 4
Fire resistance rating: 300/2

Standard size: 710
Number of poles: 6
Fire resistance rating: 300/2

AXIAL SMOKE EXTRACTION FANS

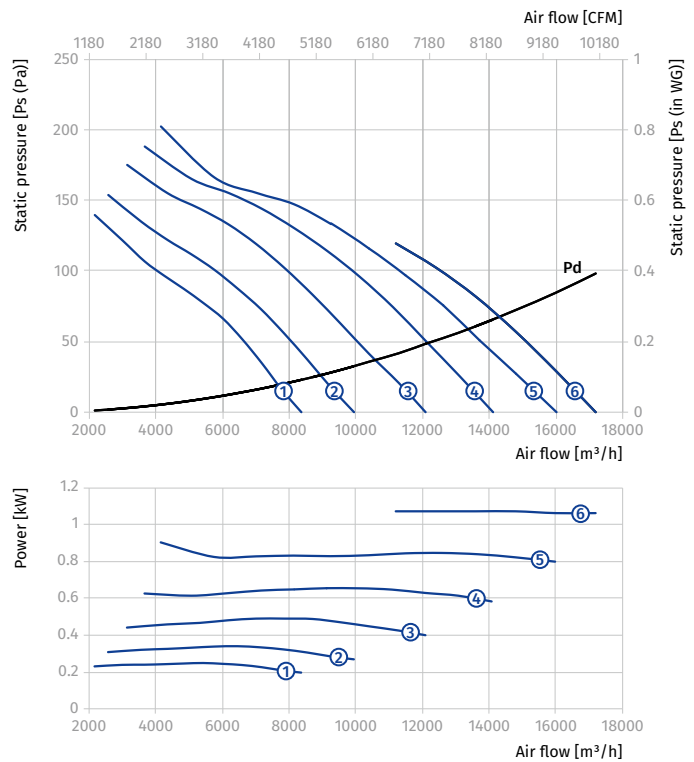
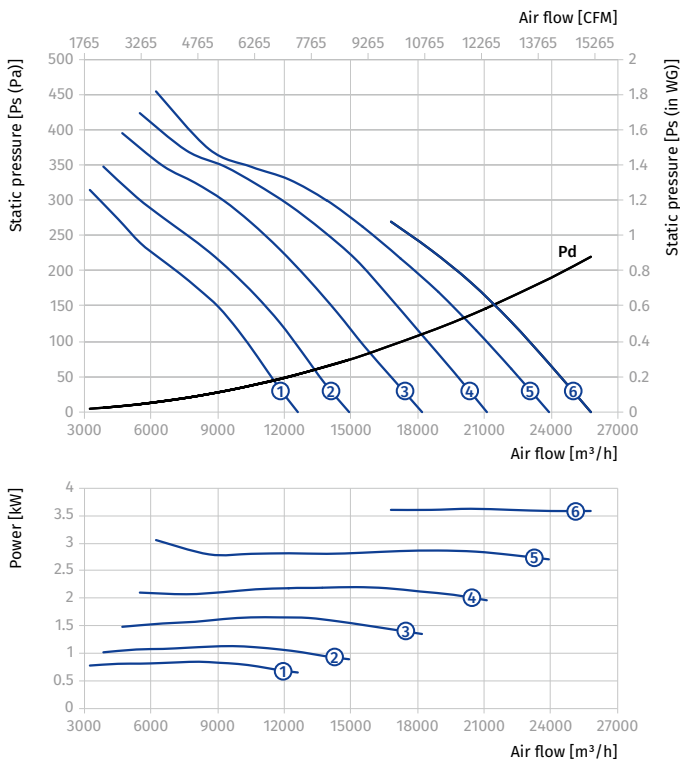

AXIS-FP 710...300/2

Size	Number of poles	Voltage [V/60 Hz]	Fan model	Installed motor power N_y [kW]	RPM [min^{-1}]	Number of blades	Blade setting angle [°]	Weight [kg]	Length L [mm]	Curve number on graph
Axis-FP 710-4/6D...300/2										
710	4/6	3~400	Axis-FP 710-4/6D/1.1/0.3-4/16.5/AL	1.1/0.3	1728/1152	4	16.5	55.5	400	①
			Axis-FP 710-4/6D/1.1/0.3-4/20/AL	1.1/0.3	1728/1152	4	20	55.5	400	②
			Axis-FP 710-4/6D/1.5/0.37-4/25/AL	1.5/0.37	1728/1152	4	25	59.5	400	③
			Axis-FP 710-4/6D/3/1-4/30/AL	3/1	1728/1152	4	30	82.5	500	④
			Axis-FP 710-4/6D/3/1-4/35/AL	3/1	1728/1152	4	35	82.5	500	⑤
			Axis-FP 710-4/6D/4.5/1.5-4/40/AL	4.5/1.5	1728/1152	4	40	118	550	⑥

Standard size: 710
 Number of poles: 4
 Fire resistance rating: 300/2

Standard size: 710
 Number of poles: 6
 Fire resistance rating: 300/2

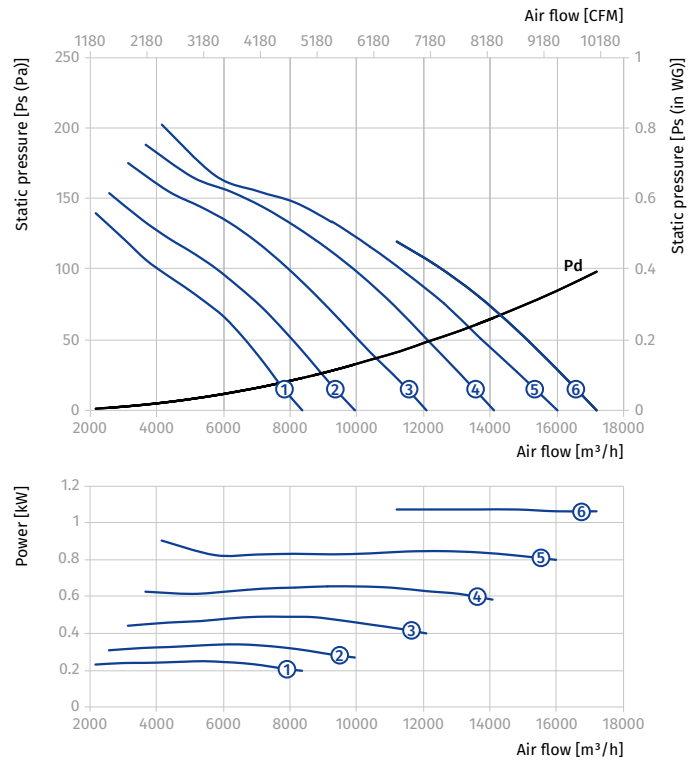
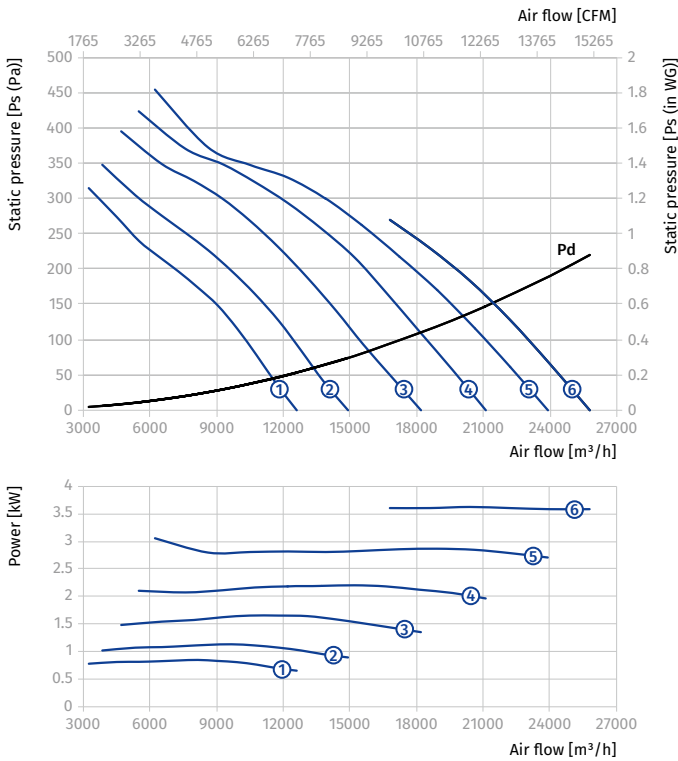

AXIAL SMOKE EXTRACTION FANS

AXIS-FP 710...300/2

Size	Number of poles	Voltage [V/60 Hz]	Fan model	Installed motor power Ny [kW]	RPM [min ⁻¹]	Number of blades	Blade setting angle [°]	Weight [kg]	Length L [mm]	Curve number on graph
Axis-FP 710-4/8D...300/2										
710	4/8	3~400	Axis-FP 710-4/8D/0.8/0.2-4/16.5/AL	0.8/0.2	1728/864	4	16.5	52.5	400	①
			Axis-FP 710-4/8D/1.2/0.3-4/20/AL	1.2/0.3	1728/864	4	20	59.5	400	②
			Axis-FP 710-4/8D/1.6/0.4-4/25/AL	1.6/0.4	1728/864	4	25	62.5	400	③
			Axis-FP 710-4/8D/2.2/0.55-4/30/AL	2.2/0.55	1728/864	4	30	76.5	500	④
			Axis-FP 710-4/8D/2.8/0.7-4/35/AL	2.8/0.7	1728/864	4	35	79.5	500	⑤
			Axis-FP 710-4/8D/3.8/1-4/40/AL	3.8/1	1728/864	4	40	88.5	500	⑥

Standard size: 710
Number of poles: 4
Fire resistance rating: 300/2

Standard size: 710
Number of poles: 8
Fire resistance rating: 300/2

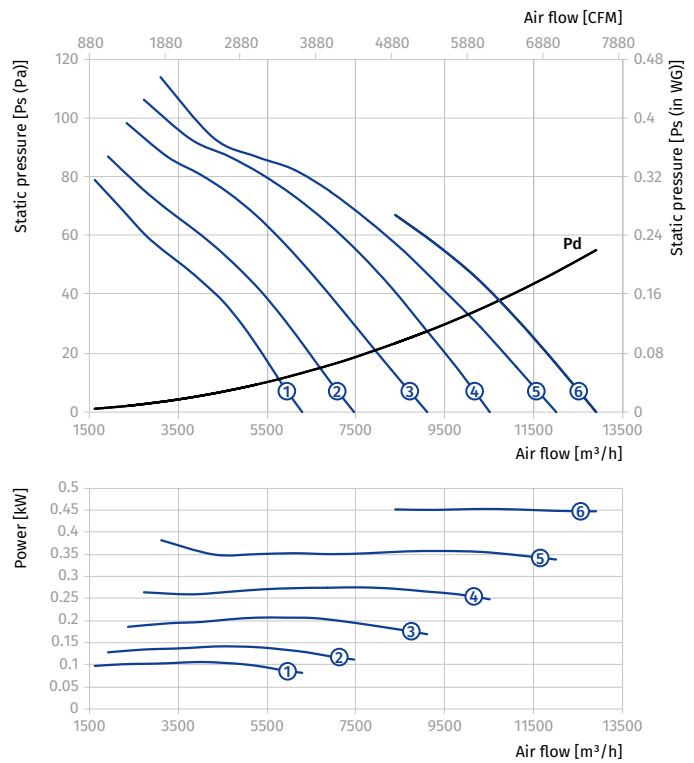
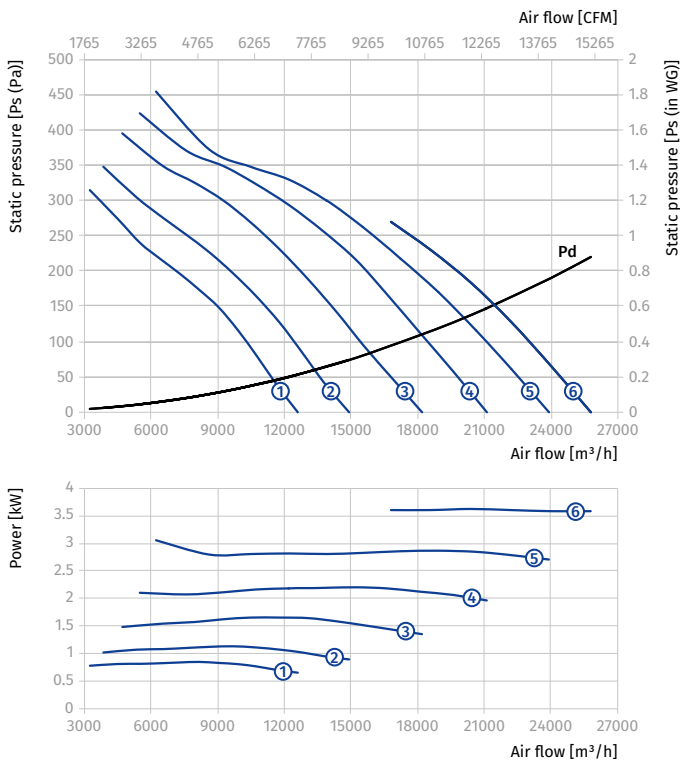

AXIS-FP 800...300/2

Size	Number of poles	Voltage [V/60 Hz]	Fan model	Installed motor power N_y [kW]	RPM [min^{-1}]	Number of blades	Blade setting angle [°]	Weight [kg]	Length L [mm]	Curve number on graph
Axis-FP 800-4D...300/2										
800	4	3~400	Axis-FP 800-4D/1.1-4/16.5/AL	1.1	1728	4	16.5	55.5	400	①
			Axis-FP 800-4D/1.5-4/20/AL	1.5	1728	4	20	61	400	②
			Axis-FP 800-4D/2.2-4/23.5/AL	2.2	1728	4	23.5	64.5	400	③
			Axis-FP 800-4D/3-4/26.5/AL	3	1728	4	26.5	83	500	④
			Axis-FP 800-4D/3-4/29/AL	3	1728	4	29	83	500	⑤
			Axis-FP 800-4D/3.7-4/31.5/AL	3.7	1728	4	31.5	83	500	⑥
			Axis-FP 800-4D/4.5-4/34/AL	4.5	1728	4	34	75.5	500	⑦
			Axis-FP 800-4D/5.5-4/38.5/AL	5.5	1728	4	38.5	95	500	⑧
Axis-FP 800-6D...300/2										
800	6	3~400	Axis-FP 800-6D/0.37-4/16.5/AL	0.37	1152	4	16.5	53	400	①
			Axis-FP 800-6D/0.55-4/20/AL	0.55	1152	4	20	57	400	②
			Axis-FP 800-6D/0.75-4/25/AL	0.75	1152	4	25	60	400	③
			Axis-FP 800-6D/1.1-4/30/AL	1.1	1152	4	30	61.5	400	④
			Axis-FP 800-6D/1.1-4/35/AL	1.1	1152	4	35	61.5	400	⑤
			Axis-FP 800-6D/1.5-4/40/AL	1.5	1152	4	40	87	500	⑥

Standard size: 800
 Number of poles: 4
 Fire resistance rating: 300/2

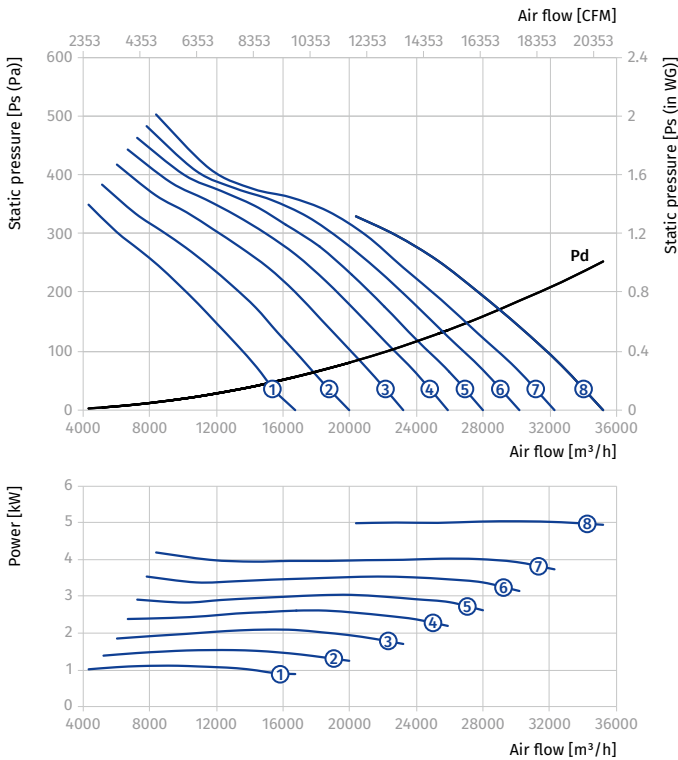

Standard size: 800
 Number of poles: 6
 Fire resistance rating: 300/2

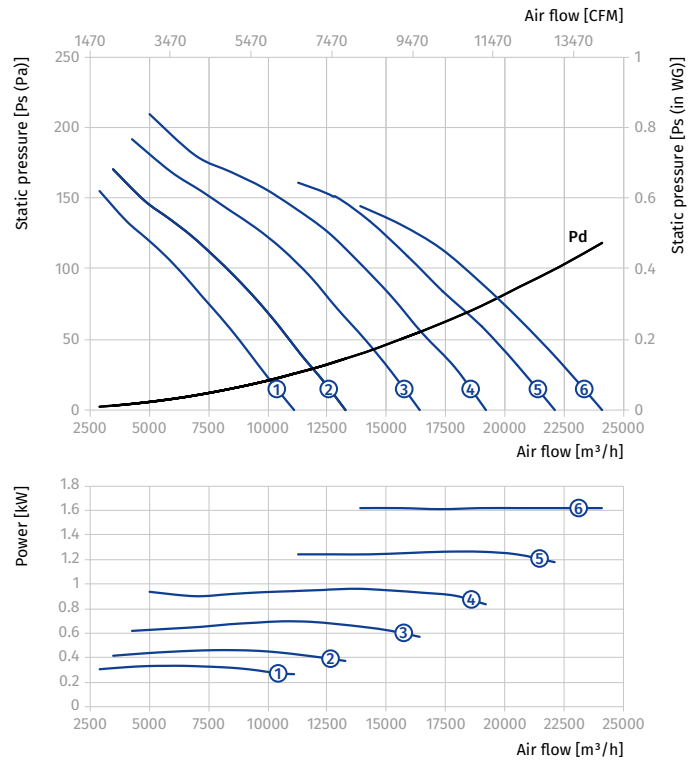

AXIS-FP 800...300/2

Size	Number of poles	Voltage [V/60 Hz]	Fan model	Installed motor power Ny [kW]	RPM [min ⁻¹]	Number of blades	Blade setting angle [°]	Weight [kg]	Length L [mm]	Curve number on graph
Axis-FP 800-4/6D...300/2										
800	4/6	3~400	Axis-FP 800-4/6D/1.1/0.3-4/16.5/AL	1.1/0.3	1728/1152	4	16.5	59.5	400	①
			Axis-FP 800-4/6D/1.5/0.37-4/20/AL	1.5/0.37	1728/1152	4	20	63.5	400	②
			Axis-FP 800-4/6D/3/1-4/26.5/AL	3/1	1728/1152	4	26.5	89	500	③
			Axis-FP 800-4/6D/3/1-4/29/AL	3/1	1728/1152	4	29	89	500	④
			Axis-FP 800-4/6D/4.5/1.5-4/31.5/AL	4.5/1.5	1728/1152	4	31.5	125.5	550	⑤
			Axis-FP 800-4/6D/6/2.2-4/34/AL	6/2.2	1728/1152	4	34	137.5	550	⑥
			Axis-FP 800-4/6D/6/2.2-4/38.5/AL	6/2.2	1728/1152	4	38.5	137.5	550	⑦

Standard size: 800
Number of poles: 4
Fire resistance rating: 300/2

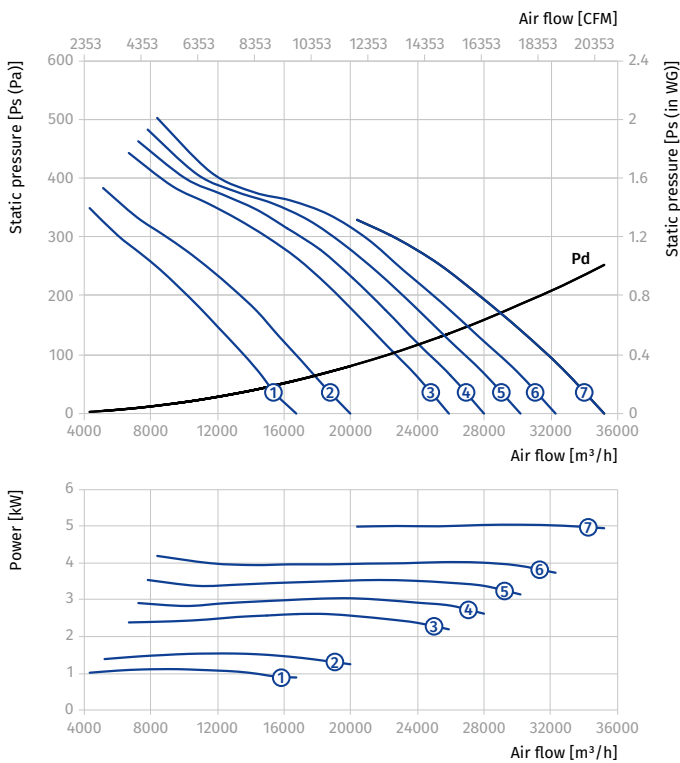

Standard size: 800
Number of poles: 6
Fire resistance rating: 300/2

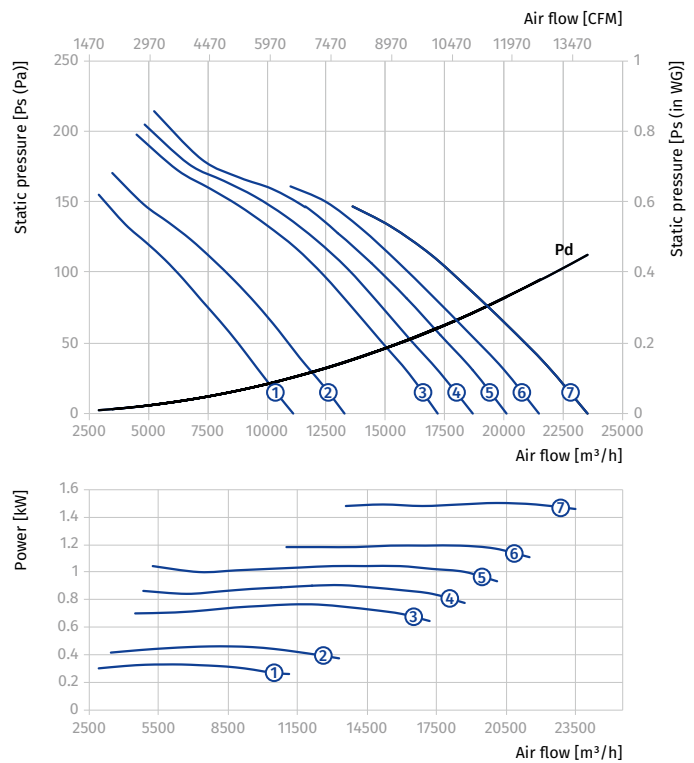

AXIS-FP 800...300/2

Size	Number of poles	Voltage [V/60 Hz]	Fan model	Installed motor power N_y [kW]	RPM [min^{-1}]	Number of blades	Blade setting angle [°]	Weight [kg]	Length L [mm]	Curve number on graph
Axis-FP 800-4/8D...300/2										
800	4/8	3~400	Axis-FP 800-4/8D/1.2/0.3-4/16.5/AL	1.2/0.3	1728/864	4	16.5	63.5	400	①
			Axis-FP 800-4/8D/1.6/0.4-4/20/AL	1.6/0.4	1728/864	4	20	66.5	400	②
			Axis-FP 800-4/8D/2.2/0.55-4/23.5/AL	2.2/0.55	1728/864	4	23.5	81	500	③
			Axis-FP 800-4/8D/2.8/0.7-4/26.5/AL	2.8/0.7	1728/864	4	26.5	84	500	④
			Axis-FP 800-4/8D/2.8/0.7-4/29/AL	2.8/0.7	1728/864	4	29	84	500	⑤
			Axis-FP 800-4/8D/3.8/1-4/31.5/AL	3.8/1	1728/864	4	31.5	95	500	⑥
			Axis-FP 800-4/8D/5/1.3-4/34/AL	5/1.3	1728/864	4	34	125.5	550	⑦
			Axis-FP 800-4/8D/5/1.3-4/38.5/AL	5/1.3	1728/864	4	38.5	125.5	550	⑧

Standard size: 800
 Number of poles: 4
 Fire resistance rating: 300/2

Standard size: 800
 Number of poles: 8
 Fire resistance rating: 300/2

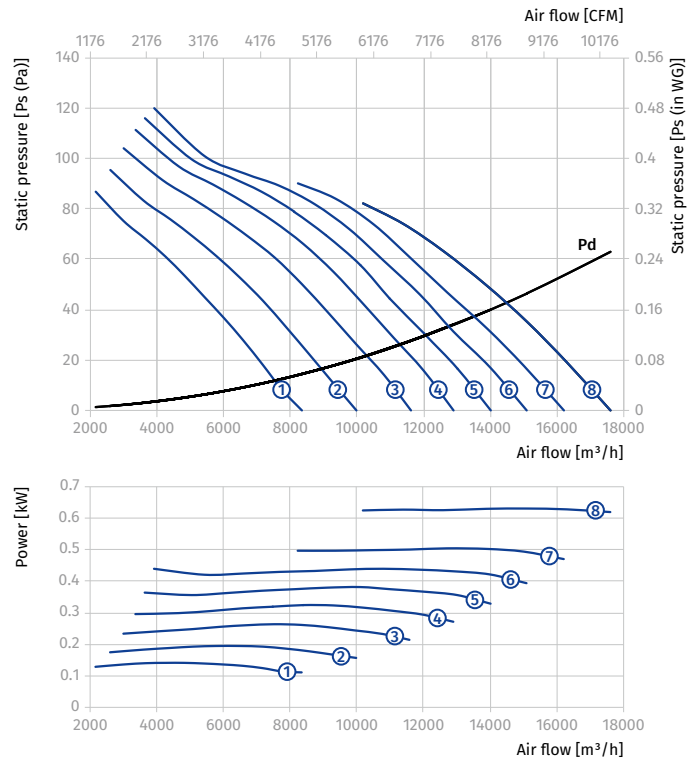
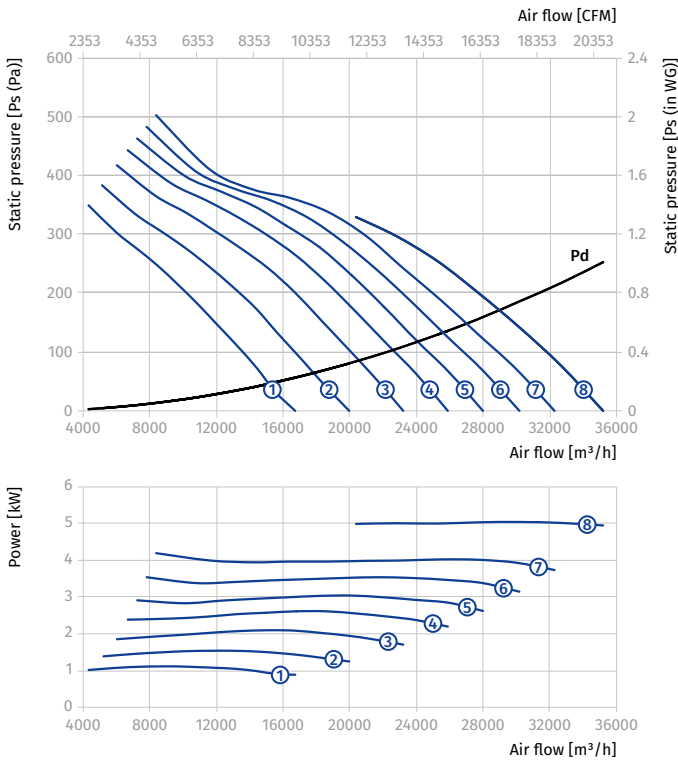

AXIAL SMOKE EXTRACTION FANS

AXIS-FP 900...300/2

Size	Number of poles	Voltage [V/60 Hz]	Fan model	Installed motor power Ny [kW]	RPM [min ⁻¹]	Number of blades	Blade setting angle [°]	Weight [kg]	Length L [mm]	Curve number on graph
Axis-FP 900-4D...300/2										
900	4	3~400	Axis-FP 900-4D/3-3/20/AL	3	1728	3	20	97	550	①
			Axis-FP 900-4D/4.5-3/26/AL	4.5	1728	3	26	89.5	550	②
			Axis-FP 900-4D/5.5-3/29/AL	5.5	1728	3	29	109.5	550	③
			Axis-FP 900-4D/7.5-3/35/AL	7.5	1728	3	35	156	600	④
			Axis-FP 900-4D/9.2-3/39/AL	9.2	1728	3	39	158	600	⑤
			Axis-FP 900-4D/11-3/43/AL	11	1728	3	43	161	600	⑥
Axis-FP 900-6D...300/2										
900	6	3~400	Axis-FP 900-6D/0.75-3/20/AL	0.75	1152	3	20	73	450	①
			Axis-FP 900-6D/1.1-3/25/AL	1.1	1152	3	25	74.5	450	②
			Axis-FP 900-6D/1.5-3/30/AL	1.5	1152	3	30	101.5	550	③
			Axis-FP 900-6D/2.2-3/36/AL	2.2	1152	3	36	93	550	④
			Axis-FP 900-6D/3-3/42/AL	3	1152	3	42	105.5	550	⑤

Standard size: 900
Number of poles: 4
Fire resistance rating: 300/2

Standard size: 900
Number of poles: 6
Fire resistance rating: 300/2

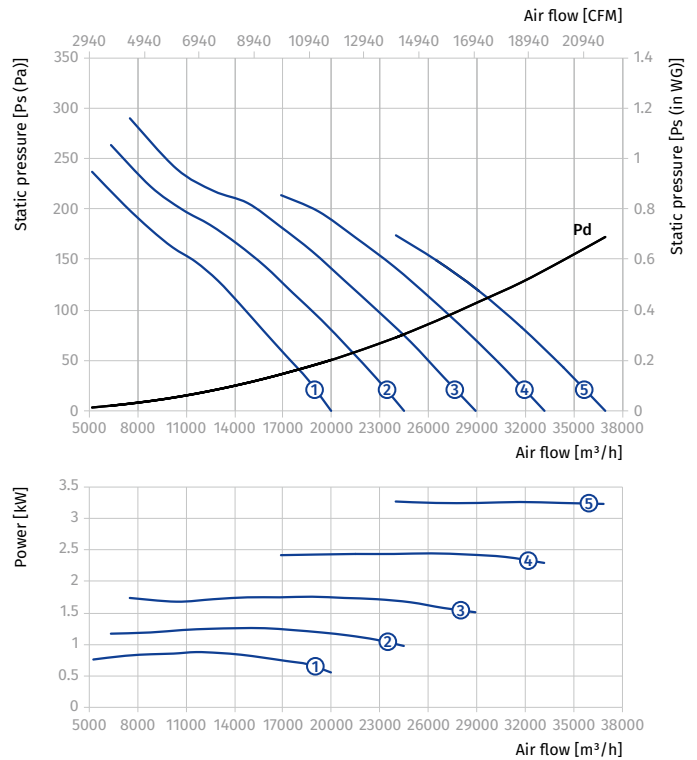
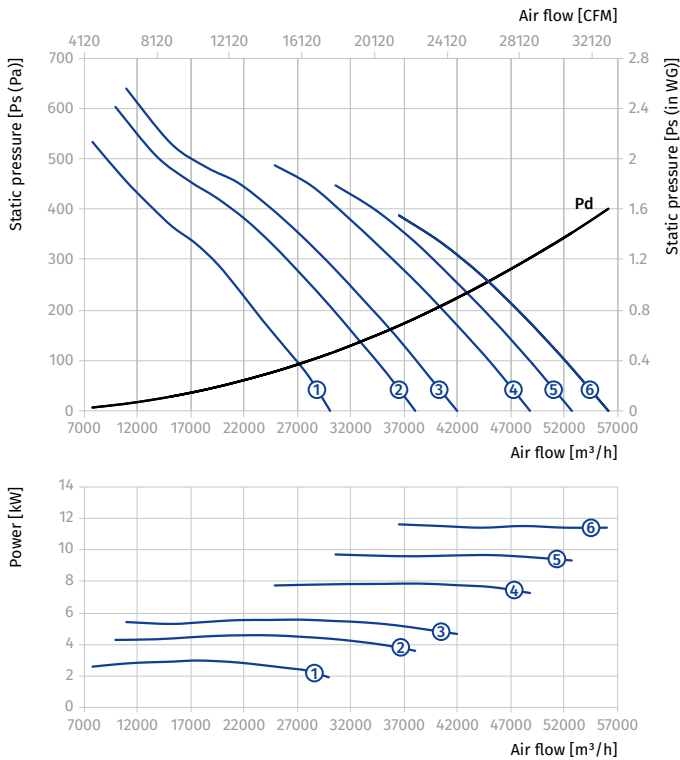

AXIS-FP 900...300/2

Size	Number of poles	Voltage [V/60 Hz]	Fan model	Installed motor power N_y [kW]	RPM [min^{-1}]	Number of blades	Blade setting angle [°]	Weight [kg]	Length L [mm]	Curve number on graph
Axis-FP 900-4/6D...300/2										
900	4/6	3~400	Axis-FP 900-4/6D/3/1-3/20/AL	3/1	1728/1152	3	20	103.5	550	①
			Axis-FP 900-4/6D/4.5/1.5-3/26/AL	4.5/1.5	1728/1152	3	26	156	600	②
			Axis-FP 900-4/6D/6/2.2-3/31/AL	6/2.2	1728/1152	3	31	168	600	③
			Axis-FP 900-4/6D/10/3.3-3/41/AL	10/3.3	1728/1152	3	41	230	750	④

Standard size: 900
 Number of poles: 4
 Fire resistance rating: 300/2

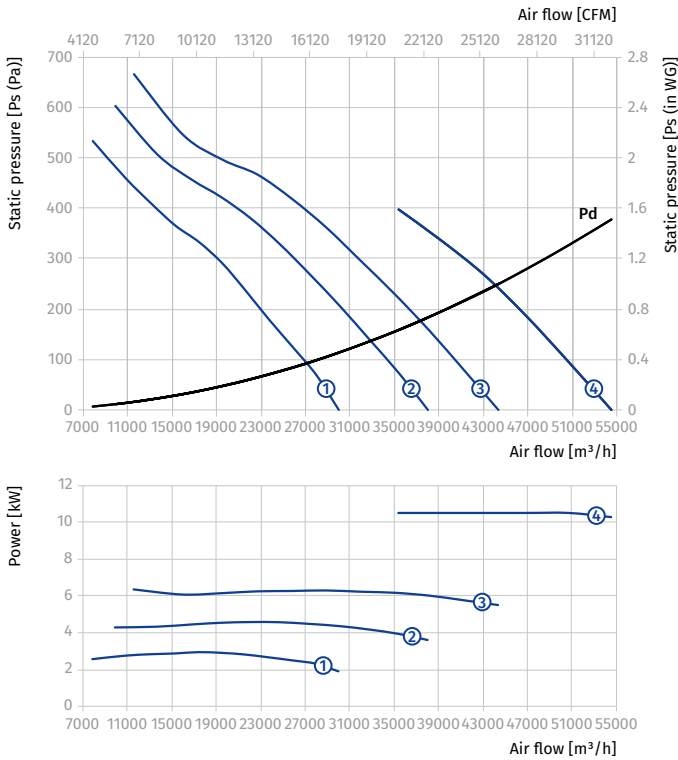

Standard size: 900
 Number of poles: 6
 Fire resistance rating: 300/2

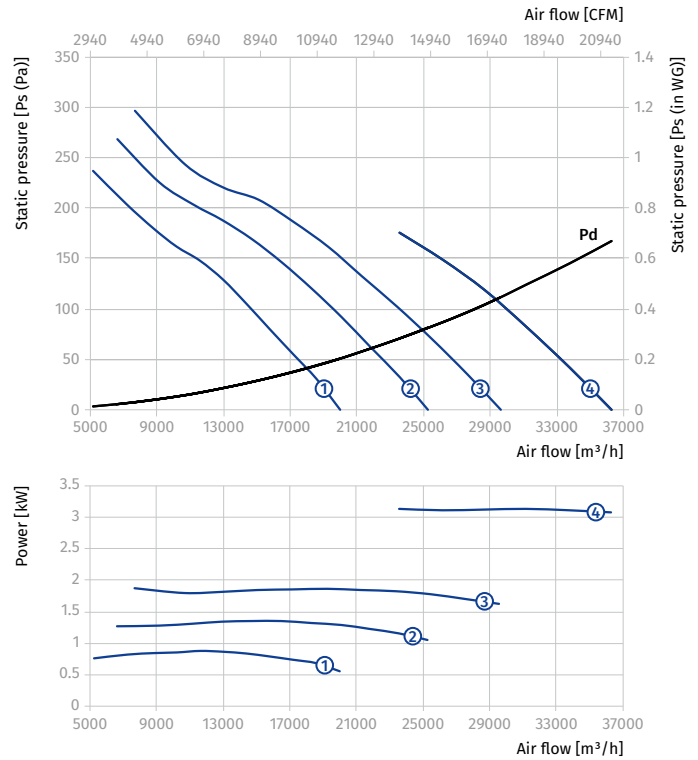

AXIS-FP 900...300/2

Size	Number of poles	Voltage [V/60 Hz]	Fan model	Installed motor power Ny [kW]	RPM [min ⁻¹]	Number of blades	Blade setting angle [°]	Weight [kg]	Length L [mm]	Curve number on graph
Axis-FP 900-4/8D...300/2										
900	4/8	3~400	Axis-FP 900-4/8D/2.8/0.7-3/20/AL	2.8/0.7	1728/864	3	20	98	550	①
			Axis-FP 900-4/8D/3.8/1-3/24/AL	3.8/1	1728/864	3	24	109.5	550	②
			Axis-FP 900-4/8D/5/1.3-3/28/AL	5/1.3	1728/864	3	28	156	600	③
			Axis-FP 900-4/8D/7.2/1.8-3/34/AL	7.2/1.8	1728/864	3	34	168	600	④
			Axis-FP 900-4/8D/11/3-3/43/AL	11/3	1728/864	3	43	229	750	⑤

Standard size: **900**
Number of poles: **4**
Fire resistance rating: **300/2**

Standard size: **900**
Number of poles: **8**
Fire resistance rating: **300/2**

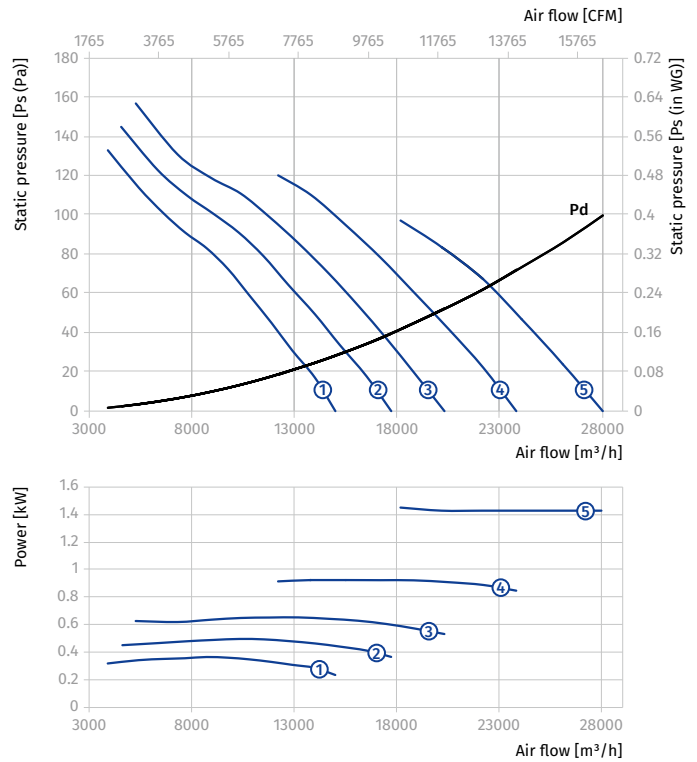
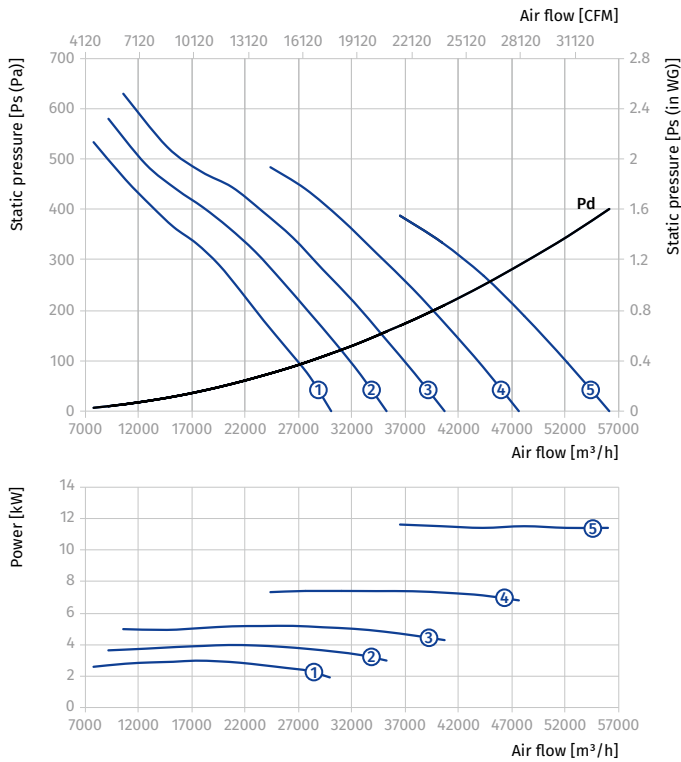

AXIS-FP 1000...300/2

Size	Number of poles	Voltage [V/60 Hz]	Fan model	Installed motor power Ny [kW]	RPM [min ⁻¹]	Number of blades	Blade setting angle [°]	Weight [kg]	Length L [mm]	Curve number on graph
Axis-FP 1000-4D...300/2										
1000	4	3~400	Axis-FP 1000-4D/5.5-5/20/AL	5.5	1728	5	20	118	550	①
			Axis-FP 1000-4D/7.5-5/24/AL	7.5	1728	5	24	167	600	②
			Axis-FP 1000-4D/9.2-5/27/AL	9.2	1728	5	27	169	600	③
			Axis-FP 1000-4D/11-5/30/AL	11	1728	5	30	172	600	④
			Axis-FP 1000-4D/15-5/34/AL	15	1728	5	34	228	750	⑤
			Axis-FP 1000-4D/18.5-5/38/AL	18.5	1728	5	38	245	750	⑥
Axis-FP 1000-6D...300/2										
1000	6	3~400	Axis-FP 1000-6D/1.5-5/20/AL	1.5	1152	5	20	110	550	①
			Axis-FP 1000-6D/2.2-5/24/AL	2.2	1152	5	24	101.5	550	②
			Axis-FP 1000-6D/3-5/29/AL	3	1152	5	29	114	550	③
			Axis-FP 1000-6D/4.5-5/33/AL	4.5	1152	5	33	158	600	④
			Axis-FP 1000-6D/5.5-5/39/AL	5.5	1152	5	39	163	600	⑤

Standard size: 1000
 Number of poles: 4
 Fire resistance rating: 300/2

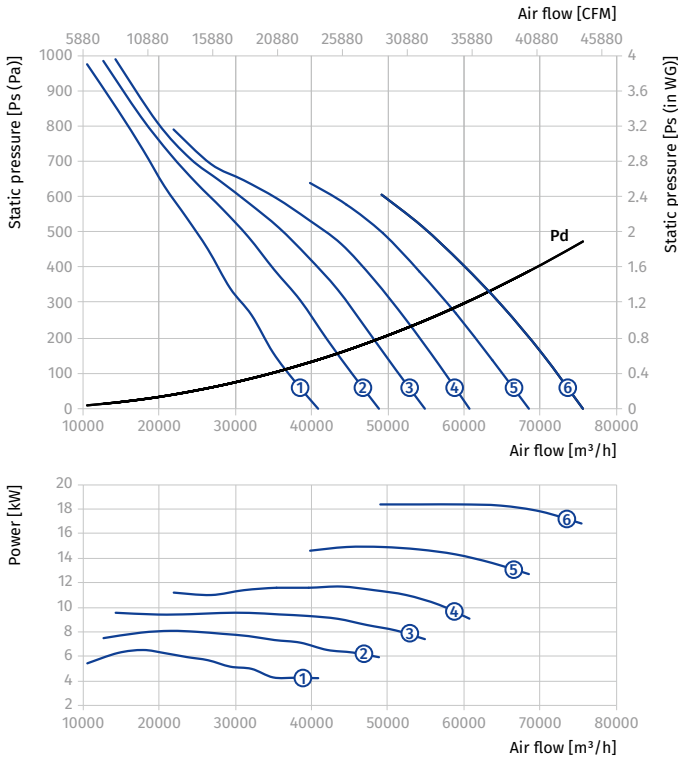

Standard size: 1000
 Number of poles: 6
 Fire resistance rating: 300/2

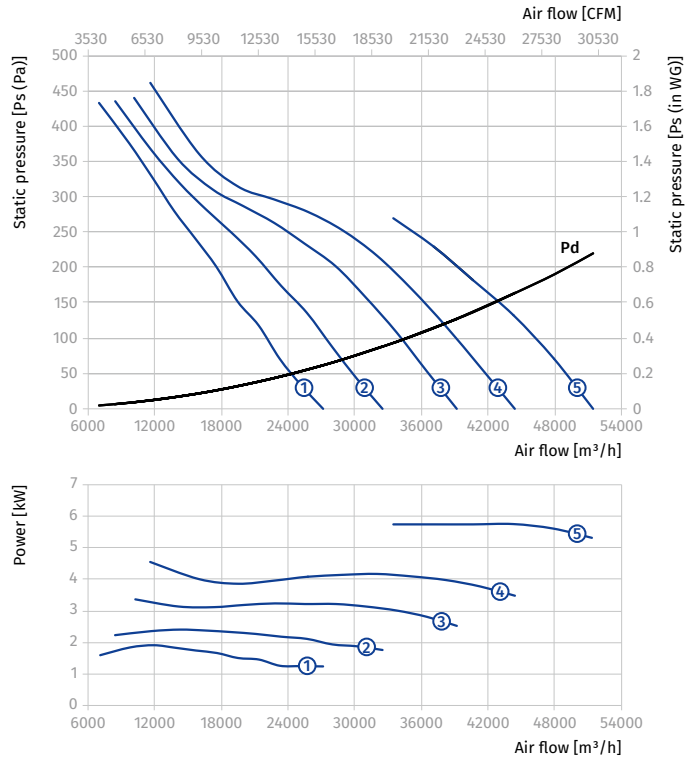

AXIS-FP 1000...300/2

Size	Number of poles	Voltage [V/60 Hz]	Fan model	Installed motor power Ny [kW]	RPM [min ⁻¹]	Number of blades	Blade setting angle [°]	Weight [kg]	Length L [mm]	Curve number on graph
Axis-FP 1000-4/6D...300/2										
1000	4/6	3~400	Axis-FP 1000-4/6D/6/2.2-5/20/AL	6/2.2	1728/1152	5	20	179	600	①
			Axis-FP 1000-4/6D/10/3.3-5/29/AL	10/3.3	1728/1152	5	29	243	750	②
			Axis-FP 1000-4/6D/14/4.5-5/34/AL	14/4.5	1728/1152	5	34	258	750	③
			Axis-FP 1000-4/6D/16/6.5-5/37/AL	16/6.5	1728/1152	5	37	326.5	800	④

Standard size: 1000
Number of poles: 4
Fire resistance rating: 300/2

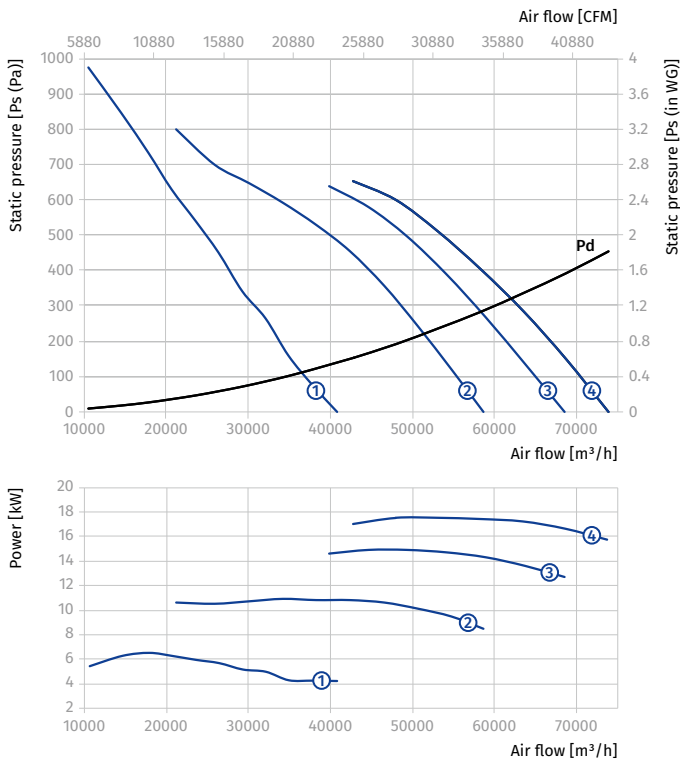

Standard size: 1000
Number of poles: 6
Fire resistance rating: 300/2

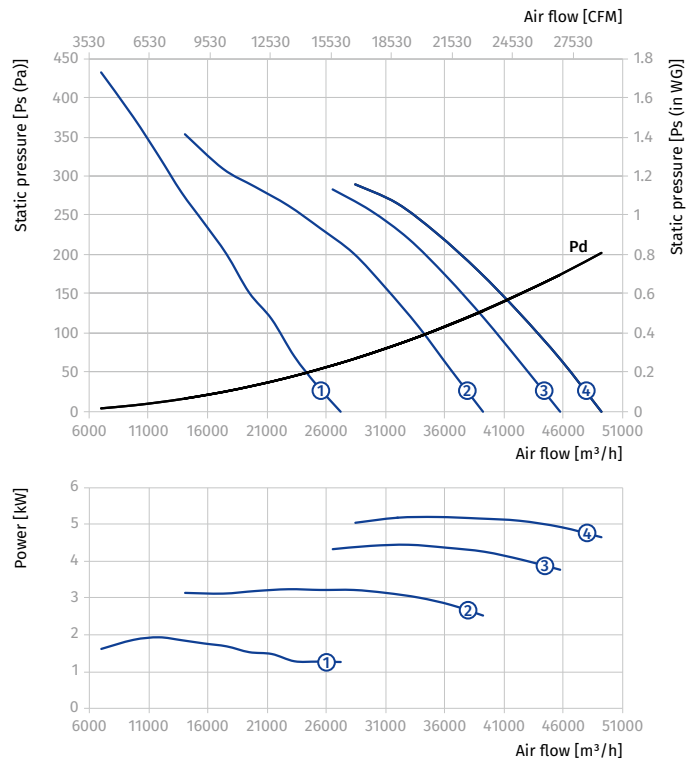

AXIS-FP 1000...300/2

Size	Number of poles	Voltage [V/60 Hz]	Fan model	Installed motor power N_y [kW]	RPM [min^{-1}]	Number of blades	Blade setting angle [°]	Weight [kg]	Length L [mm]	Curve number on graph
Axis-FP 1000-4/8D...300/2										
1000	4/8	3~400	Axis-FP 1000-4/8D/5/1.3-5/20/AL	5/1.3	1728/864	5	20	167	600	①
			Axis-FP 1000-4/8D/7.2/1.8-5/24/AL	7.2/1.8	1728/864	5	24	179	600	②
			Axis-FP 1000-4/8D/11/3-5/30/AL	11/3	1728/864	5	30	242	750	③
			Axis-FP 1000-4/8D/14/3.5-5/34/AL	14/3.5	1728/864	5	34	258	750	④
			Axis-FP 1000-4/8D/17/4.3-5/38/AL	17/4.3	1728/864	5	38	293.5	800	⑤

Standard size: 1000
 Number of poles: 4
 Fire resistance rating: 300/2

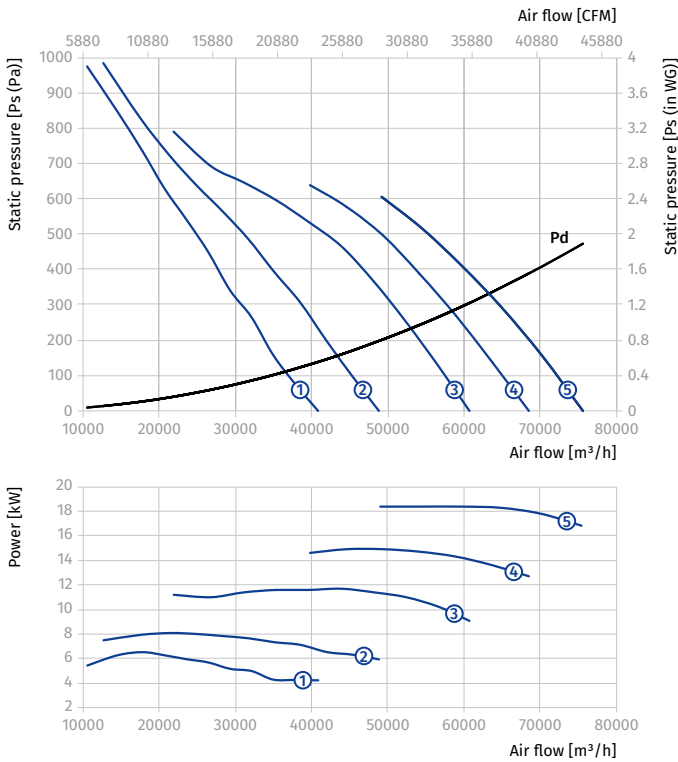

Standard size: 1000
 Number of poles: 8
 Fire resistance rating: 300/2

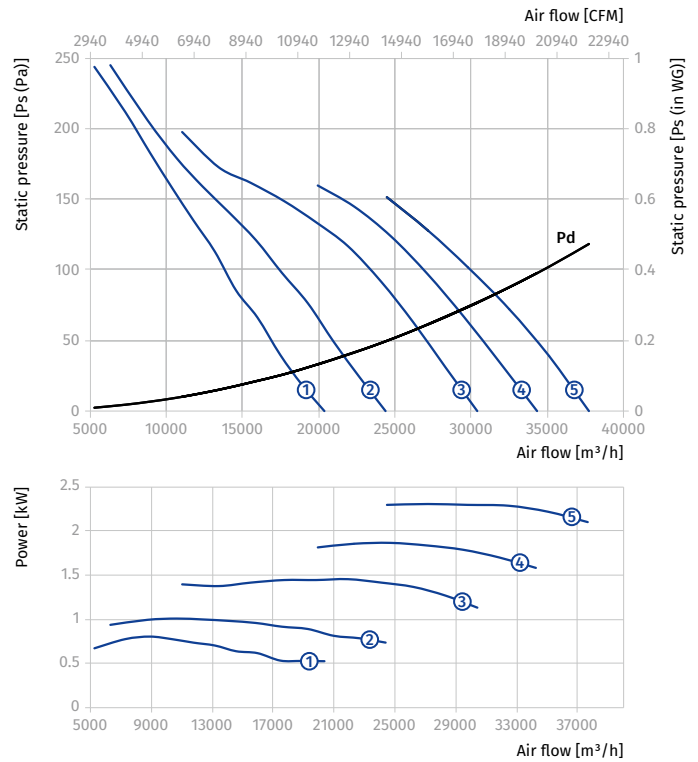

AXIS-FP 1120...300/2

Size	Number of poles	Voltage [V/60 Hz]	Fan model	Installed motor power Ny [kW]	RPM [min ⁻¹]	Number of blades	Blade setting angle [°]	Weight [kg]	Length L [mm]	Curve number on graph
Axis-FP 1120-4D...300/2										
1120	4	3~400	Axis-FP 1120-4D/7.5-5/20/AL	7.5	1728	5	20	185	600	①
			Axis-FP 1120-4D/9.2-5/23/AL	9.2	1728	5	23	187	600	②
			Axis-FP 1120-4D/11-5/26/AL	11	1728	5	26	190	600	③
			Axis-FP 1120-4D/15-5/30/AL	15	1728	5	30	280	750	④
			Axis-FP 1120-4D/18.5-5/33/AL	18.5	1728	5	33	297	750	⑤
			Axis-FP 1120-4D/22-5/36/AL	22	1728	5	36	337	800	⑥
Axis-FP 1120-6D...300/2										
1120	6	3~400	Axis-FP 1120-6D/2.2-5/20/AL	2.2	1152	5	20	134	550	①
			Axis-FP 1120-6D/3-5/25/AL	3	1152	5	25	147	550	②
			Axis-FP 1120-6D/4.5-5/29/AL	4.5	1152	5	29	176	600	③
			Axis-FP 1120-6D/5.5-5/33/AL	5.5	1152	5	33	181	600	④
			Axis-FP 1120-6D/7.5-5/38/AL	7.5	1152	5	38	192	600	⑤
			Axis-FP 1120-6D/9.2-5/43/AL	9.2	1152	5	43	284	750	⑥

Standard size: 1120
Number of poles: 4
Fire resistance rating: 300/2

Standard size: 1120
Number of poles: 6
Fire resistance rating: 300/2

AXIAL SMOKE EXTRACTION FANS

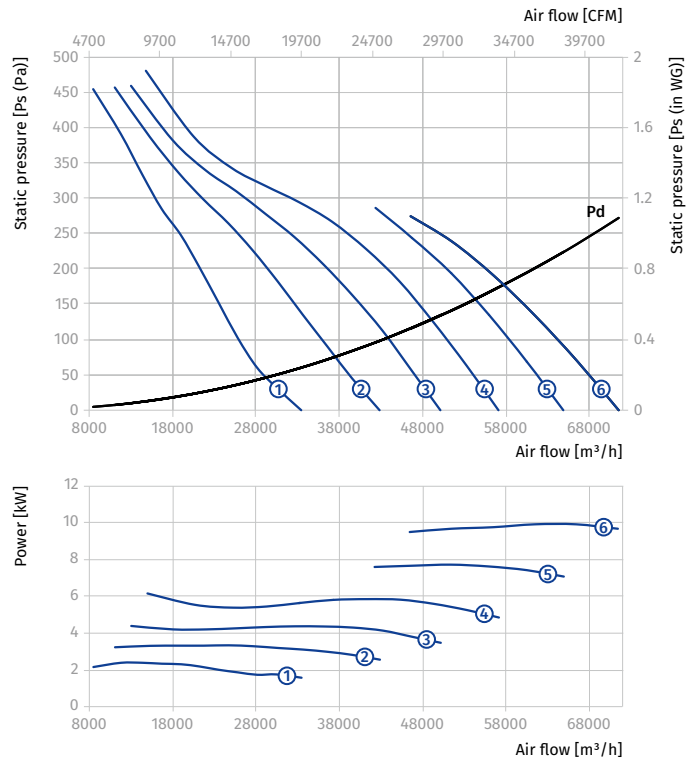
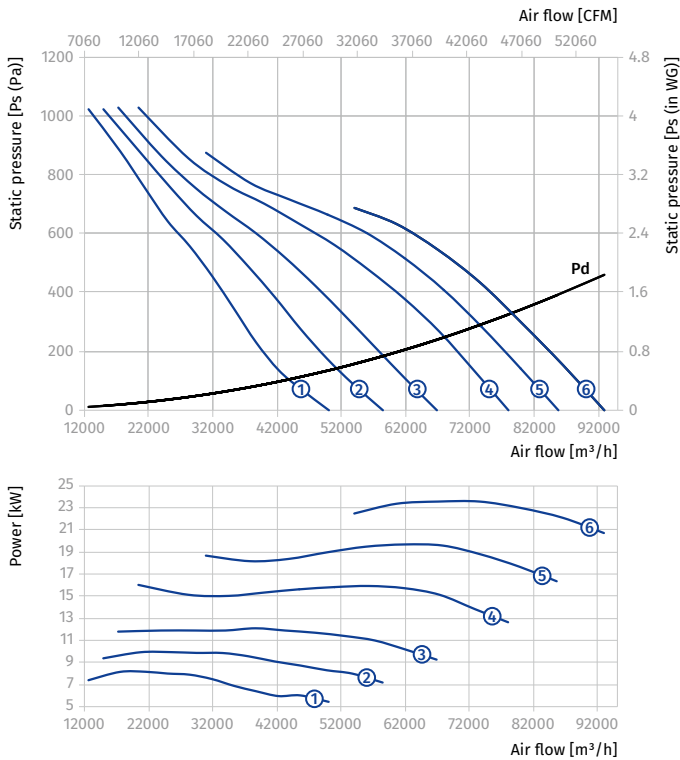

AXIS-FP 1120...300/2

Size	Number of poles	Voltage [V/60 Hz]	Fan model	Installed motor power N_y [kW]	RPM [min^{-1}]	Number of blades	Blade setting angle [°]	Weight [kg]	Length L [mm]	Curve number on graph
Axis-FP 1120-4/6D...300/2										
1120	4/6	3~400	Axis-FP 1120-4/6D/10/3.3-5/25/AL	10/3.3	1728/1152	5	25	295	750	①
			Axis-FP 1120-4/6D/14/4.5-5/29/AL	14/4.5	1728/1152	5	29	310	750	②
			Axis-FP 1120-4/6D/16/6.5-5/31/AL	16/6.5	1728/1152	5	31	382	800	③
			Axis-FP 1120-4/6D/20/8.5-5/34/AL	20/8.5	1728/1152	5	34	385	800	④

Standard size: 1120
 Number of poles: 4
 Fire resistance rating: 300/2

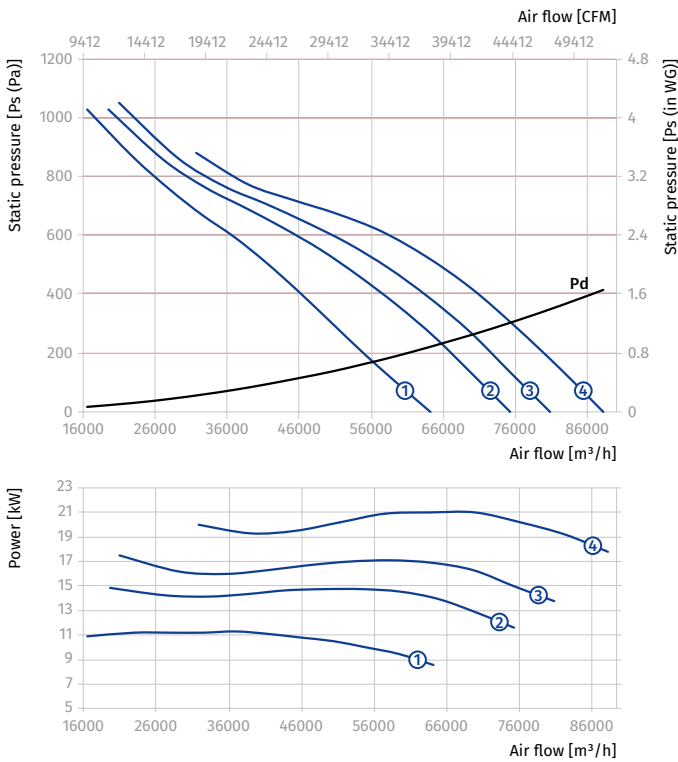

Standard size: 1120
 Number of poles: 6
 Fire resistance rating: 300/2

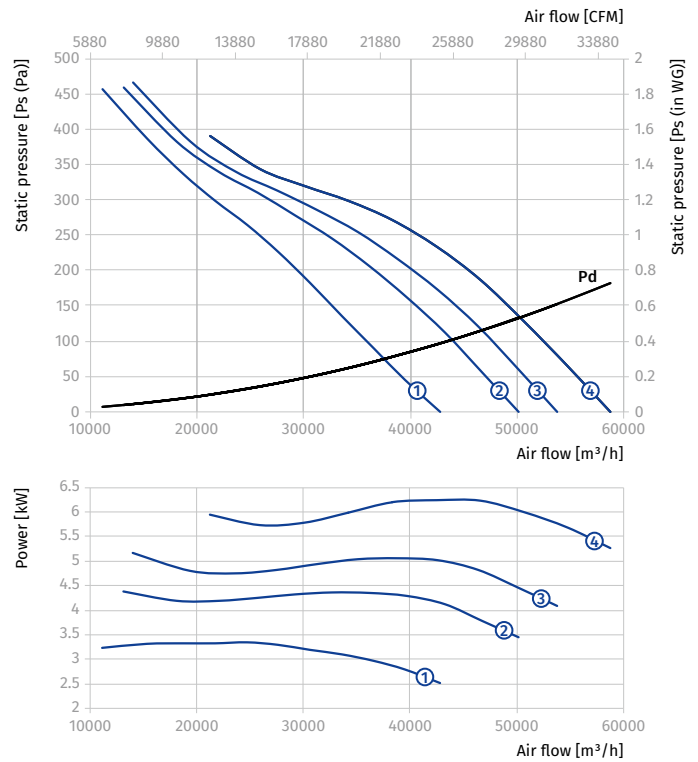

AXIAL SMOKE EXTRACTION FANS

AXIS-FP 1120...300/2

Size	Number of poles	Voltage [V/60 Hz]	Fan model	Installed motor power Ny [kW]	RPM [min ⁻¹]	Number of blades	Blade setting angle [°]	Weight [kg]	Length L [mm]	Curve number on graph
Axis-FP 1120-4/8D...300/2										
1120	4/8	3~400	Axis-FP 1120-4/8D/7.2/1.8-5/20/AL	7.2/1.8	1728/864	5	20	197	600	①
			Axis-FP 1120-4/8D/11/3-5/26/AL	11/3	1728/864	5	26	294	750	②
			Axis-FP 1120-4/8D/14/3.5-5/29/AL	14/3.5	1728/864	5	29	310	750	③
			Axis-FP 1120-4/8D/17/4.3-5/32/AL	17/4.3	1728/864	5	32	349	800	④
			Axis-FP 1120-4/8D/20/5-5/34/AL	20/5	1728/864	5	34	377	800	⑤

Standard size: 1120
Number of poles: 4
Fire resistance rating: 300/2

Standard size: 1120
Number of poles: 8
Fire resistance rating: 300/2

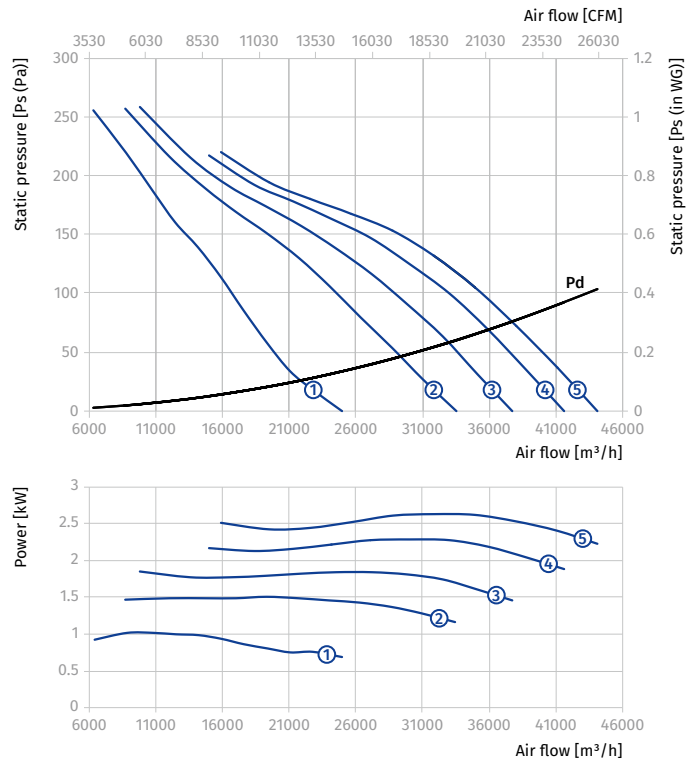
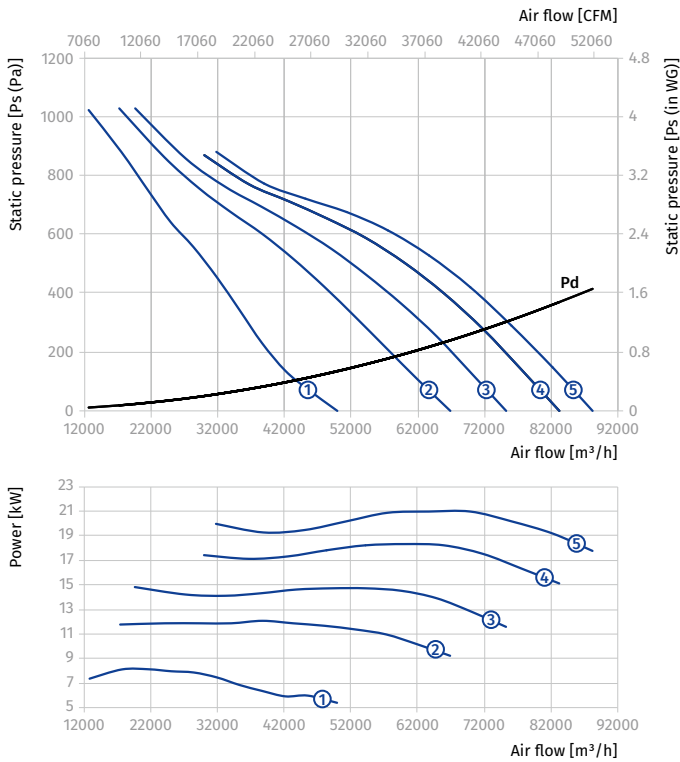

AXIAL SMOKE EXTRACTION FANS

AXIS-FP 1250...300/2

Size	Number of poles	Voltage [V/60 Hz]	Fan model	Installed motor power N_y [kW]	RPM [min^{-1}]	Number of blades	Blade setting angle [°]	Weight [kg]	Length L [mm]	Curve number on graph
Axis-FP 1250-4D...300/2										
1250	4	3~400	Axis-FP 1250-4D/18.5-4/23/AL	18.5	1728	4	23	316	750	①
			Axis-FP 1250-4D/22-4/28/AL	22	1728	4	28	357	800	②
			Axis-FP 1250-4D/30-4/34/AL	30	1728	4	34	418	850	③
Axis-FP 1250-6D...300/2										
1250	6	3~400	Axis-FP 1250-6D/4.5-4/22/AL	4.5	1152	4	22	211.5	600	①
			Axis-FP 1250-6D/5.5-4/25/AL	5.5	1152	4	25	216.5	600	②
			Axis-FP 1250-6D/7.5-4/30/AL	7.5	1152	4	30	227.5	600	③
			Axis-FP 1250-6D/9.2-4/34/AL	9.2	1152	4	34	302.5	750	④
			Axis-FP 1250-6D/11-4/38/AL	11	1152	4	38	316	750	⑤

Standard size: 1250
 Number of poles: 4
 Fire resistance rating: 300/2

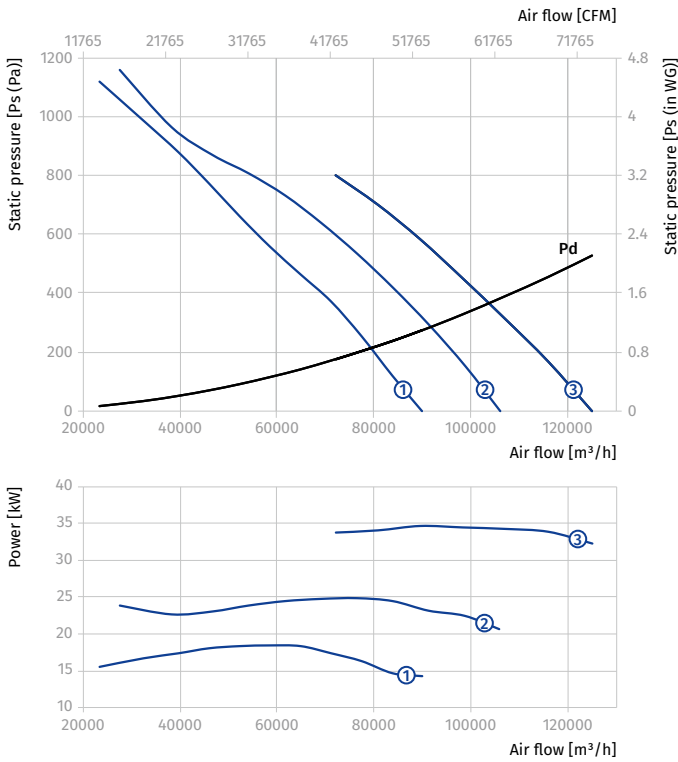

Standard size: 1250
 Number of poles: 6
 Fire resistance rating: 300/2

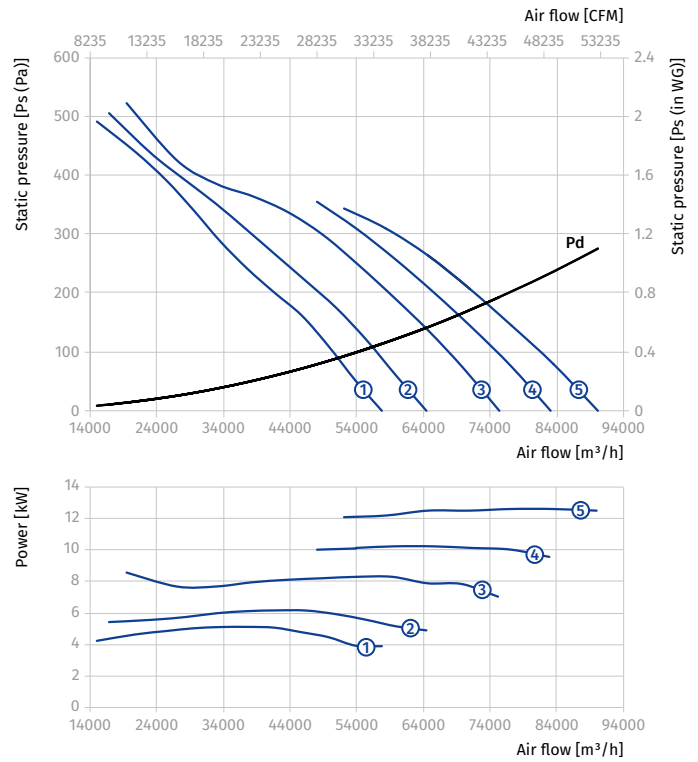

AXIS-FP 1250...300/2

Size	Number of poles	Voltage [V/60 Hz]	Fan model	Installed motor power Ny [kW]	RPM [min ⁻¹]	Number of blades	Blade setting angle [°]	Weight [kg]	Length L [mm]	Curve number on graph
Axis-FP 1250-4/6D...300/2										
1250	4/6	3~400	Axis-FP 1250-4/6D/16/6.5-4/22/AL	16/6.5	1728/1152	4	22	402	800	①
			Axis-FP 1250-4/6D/20/8.5-4/26/AL	20/8.5	1728/1152	4	26	405	800	②
			Axis-FP 1250-4/6D/26/9-4/30/AL	26/9	1728/1152	4	30	503	850	③

Standard size: 1250
Number of poles: 4
Fire resistance rating: 300/2

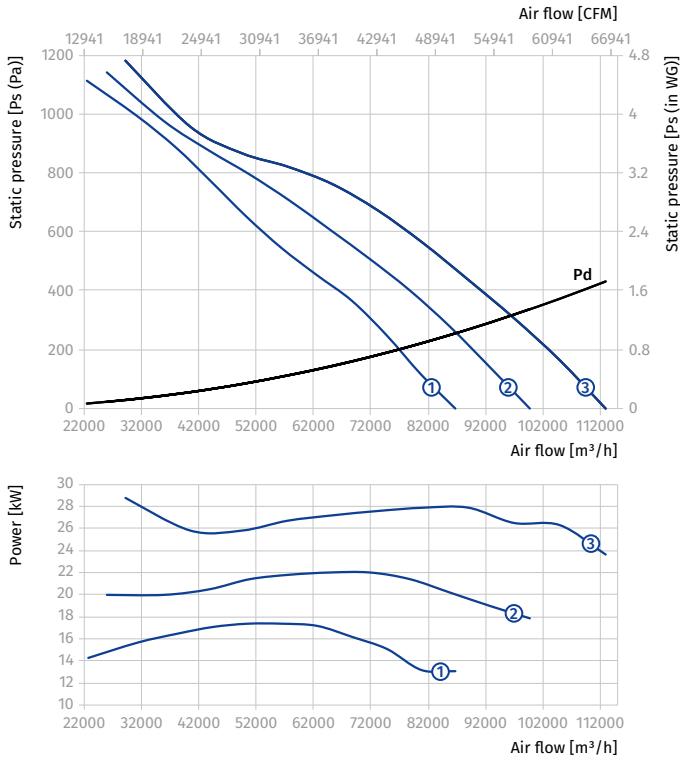

Standard size: 1250
Number of poles: 6
Fire resistance rating: 300/2

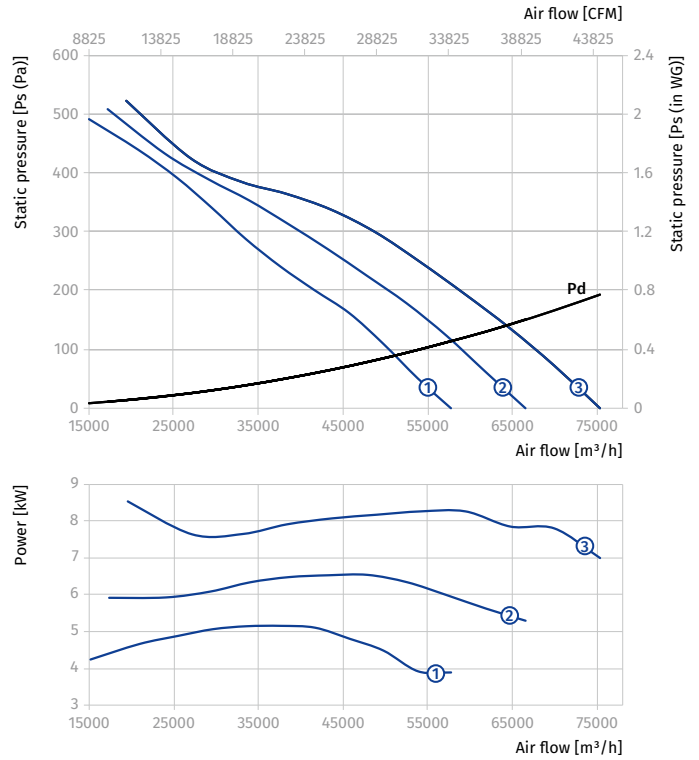

AXIS-FP 1250...300/2

Size	Number of poles	Voltage [V/60 Hz]	Fan model	Installed motor power N_y [kW]	RPM [min^{-1}]	Number of blades	Blade setting angle [°]	Weight [kg]	Length L [mm]	Curve number on graph
Axis-FP 1250-4/8D...300/2										
1250	4/8	3~400	Axis-FP 1250-4/8D/17/4.3-4/23/AL	17/4.3	1728/864	4	23	369	800	①
			Axis-FP 1250-4/8D/20/5-4/26/AL	20/5	1728/864	4	26	397	800	②
			Axis-FP 1250-4/8D/28/6.5-4/32/AL	28/6.5	1728/864	4	32	458	850	③

Standard size: 1250
 Number of poles: 4
 Fire resistance rating: 300/2

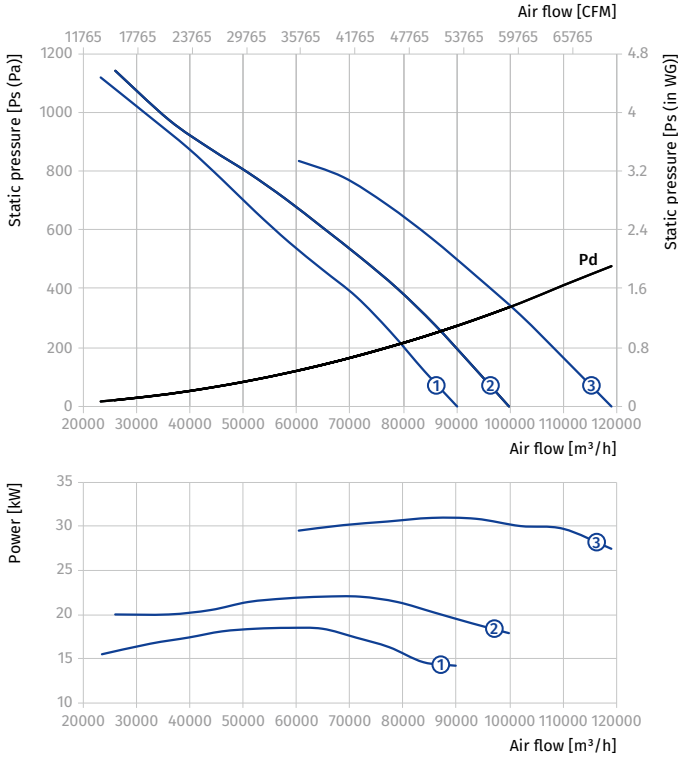

Standard size: 1250
 Number of poles: 8
 Fire resistance rating: 300/2

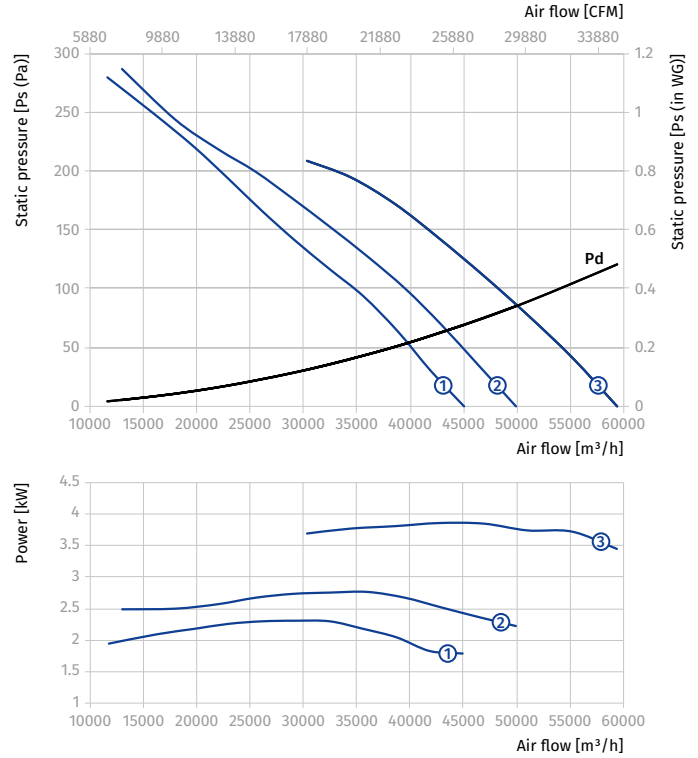

Technical data AXIS-FP...400/2

AXIS-FP 400...400/2

Size	Number of poles	Voltage [V/60 Hz]	Fan model	Installed motor power Ny [kW]	RPM [min ⁻¹]	Number of blades	Blade setting angle [°]	Weight [kg]	Length L [mm]	Curve number on graph
Axis-FP 400-2D...400/2										
400	2	3~400	Axis-FP 400-2D/0.75-4/20/AL	0.75	3456	4	20	30.3	400	①
			Axis-FP 400-2D/1.1-4/25/AL	1.1	3456	4	25	32.8	400	②
			Axis-FP 400-2D/1.5-4/30/AL	1.5	3456	4	30	33.8	400	③
			Axis-FP 400-2D/2.2-4/35/AL	2.2	3456	4	35	34.8	400	④
			Axis-FP 400-2D/3-4/40/AL	3	3456	4	40	39.8	400	⑤
Axis-FP 400-4D...400/2										
400	4	3~400	Axis-FP 400-4D/0.37-4/25/AL	0.37	1728	4	25	25.2	400	①
			Axis-FP 400-4D/0.37-4/30/AL	0.37	1728	4	30	25.5	400	②
			Axis-FP 400-4D/0.37-4/35/AL	0.37	1728	4	35	25.2	400	③
			Axis-FP 400-4D/0.37-6/35/AL	0.37	1728	6	35	25.3	400	④
			Axis-FP 400-4D/0.55-6/40/AL	0.55	1728	6	40	25.3	400	⑤

Standard size: 400
Number of poles: 2
Fire resistance rating: 400/2

Standard size: 400
Number of poles: 4
Fire resistance rating: 400/2

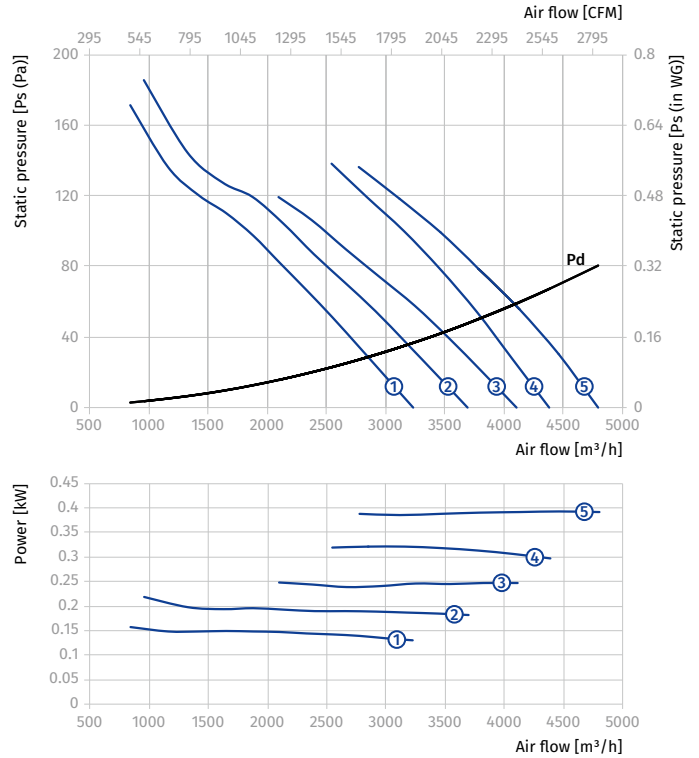
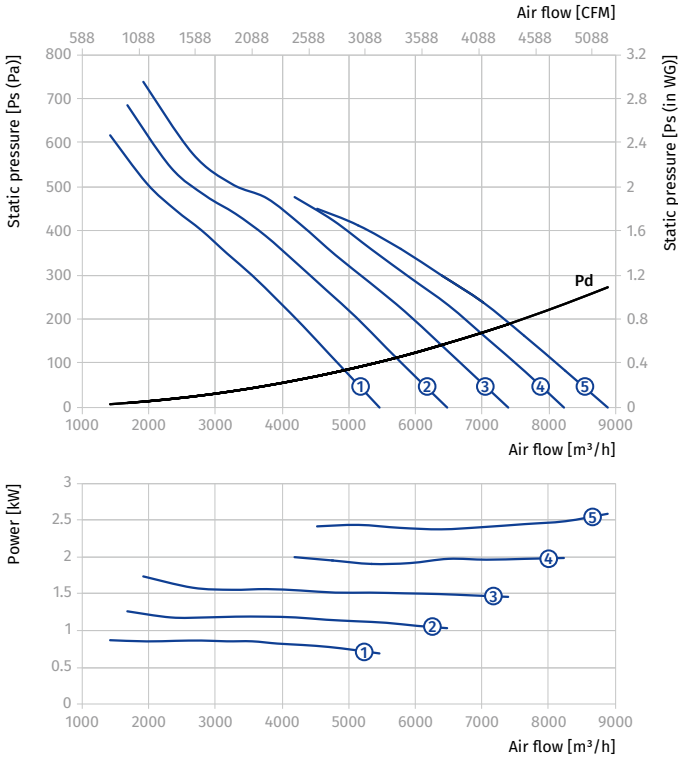

AXIS-FP 400...400/2

Size	Number of poles	Voltage [V/60 Hz]	Fan model	Installed motor power N_y [kW]	RPM [min ⁻¹]	Number of blades	Blade setting angle [°]	Weight [kg]	Length L [mm]	Curve number on graph
Axis-FP 400-2/4D...400/2										
400	2/4	3~400	Axis-FP 400-2/4D/1.1/0.25-4/20/AL	1.1/0.25	3456/1728	4	20	31.3	400	①
			Axis-FP 400-2/4D/1.1/0.25-4/25/AL	1.1/0.25	3456/1728	4	25	31.3	400	②
			Axis-FP 400-2/4D/1.5/0.37-4/30/AL	1.5/0.37	3456/1728	4	30	36.8	400	③
			Axis-FP 400-2/4D/2.5/0.65-4/35/AL	2.5/0.65	3456/1728	4	35	49.9	500	④
			Axis-FP 400-2/4D/3.1/0.8-4/40/AL	3.1/0.8	3456/1728	4	40	51	500	⑤

Standard size: 400
 Number of poles: 2
 Fire resistance rating: 400/2

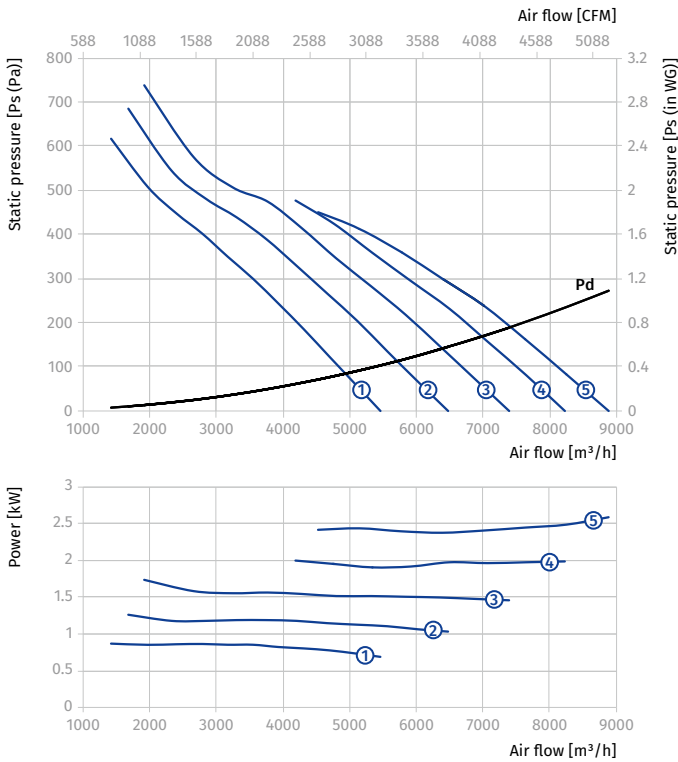

Standard size: 400
 Number of poles: 4
 Fire resistance rating: 400/2

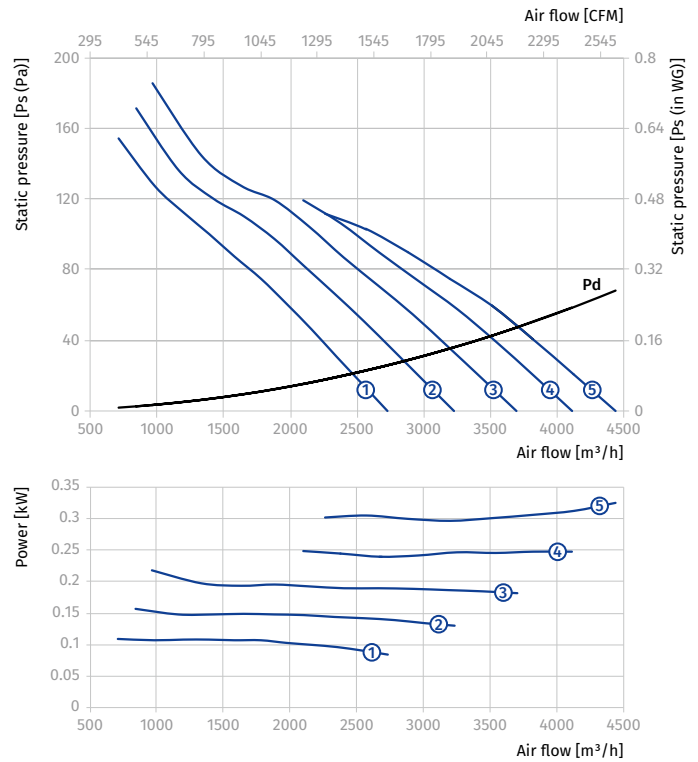

AXIAL SMOKE EXTRACTION FANS

AXIS-FP 450...400/2

Size	Number of poles	Voltage [V/60 Hz]	Fan model	Installed motor power Ny [kW]	RPM [min ⁻¹]	Number of blades	Blade setting angle [°]	Weight [kg]	Length L [mm]	Curve number on graph
Axis-FP 450-2D...400/2										
450	2	3~400	Axis-FP 450-2D/1.5-4/20/AL	1.5	3456	4	20	35.3	400	①
			Axis-FP 450-2D/2.2-4/25/AL	2.2	3456	4	25	36.3	400	②
			Axis-FP 450-2D/2.2-4/30/AL	2.2	3456	4	30	36.3	400	③
			Axis-FP 450-2D/3-6/30/AL	3	3456	6	30	41.7	400	④
			Axis-FP 450-2D/3.7-6/35/AL	3.7	3456	6	35	54.1	500	⑤
Axis-FP 450-4D...400/2										
450	4	3~400	Axis-FP 450-4D/0.37-4/20/AL	0.37	1728	4	20	26.8	400	①
			Axis-FP 450-4D/0.37-4/25/AL	0.37	1728	4	25	26.8	400	②
			Axis-FP 450-4D/0.37-4/30/AL	0.37	1728	4	30	26.8	400	③
			Axis-FP 450-4D/0.37-4/35/AL	0.37	1728	4	35	26.8	400	④
			Axis-FP 450-4D/0.55-4/40/AL	0.55	1728	4	40	27.8	400	⑤
			Axis-FP 450-4D/0.55-4/45/AL	0.55	1728	4	45	27.8	400	⑥

Standard size: 450
Number of poles: 2
Fire resistance rating: 400/2

Standard size: 450
Number of poles: 4
Fire resistance rating: 400/2

AXIAL SMOKE EXTRACTION FANS

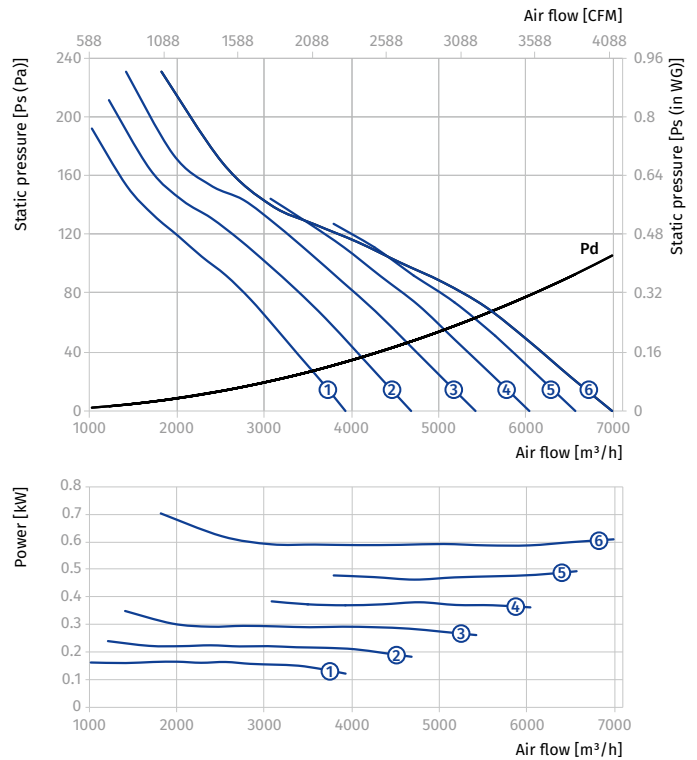
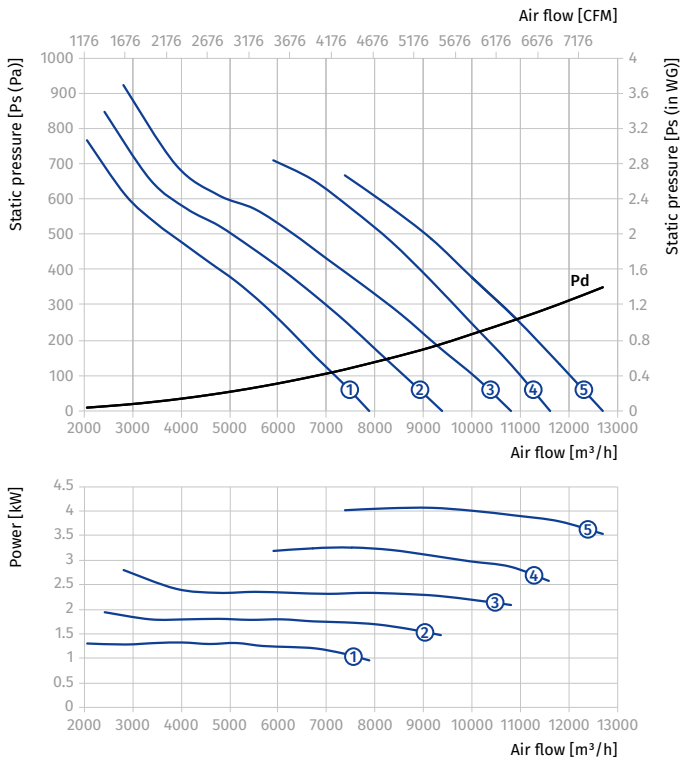

AXIS-FP 450...400/2

Size	Number of poles	Voltage [V/60 Hz]	Fan model	Installed motor power Ny [kW]	RPM [min ⁻¹]	Number of blades	Blade setting angle [°]	Weight [kg]	Length L [mm]	Curve number on graph
Axis-FP 450-2/4D...400/2										
450	2/4	3~400	Axis-FP 450-2/4D/1.5/0.37-4/20/AL	1.5/0.37	3456/1728	4	20	38.4	400	①
			Axis-FP 450-2/4D/2.5/0.65-4/25/AL	2.5/0.65	3456/1728	4	25	51.8	500	②
			Axis-FP 450-2/4D/2.5/0.65-4/30/AL	2.5/0.65	3456/1728	4	30	51.8	500	③
			Axis-FP 450-2/4D/3.1/0.8-6/30/AL	3.1/0.8	3456/1728	6	30	53.1	500	④
			Axis-FP 450-2/4D/4.4/1.1-6/35/AL	4.4/1.1	3456/1728	6	35	65	500	⑤

Standard size: 450
 Number of poles: 2
 Fire resistance rating: 400/2

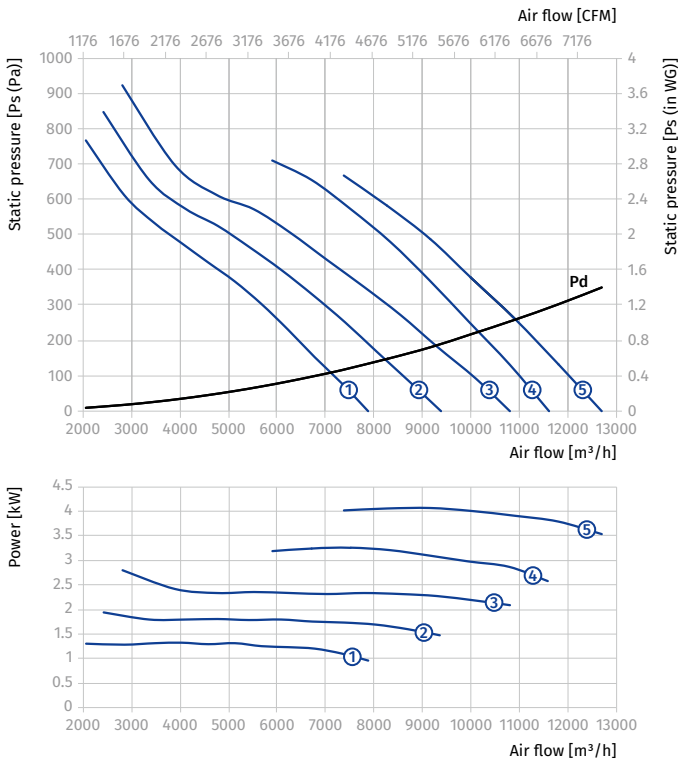

Standard size: 450
 Number of poles: 4
 Fire resistance rating: 400/2

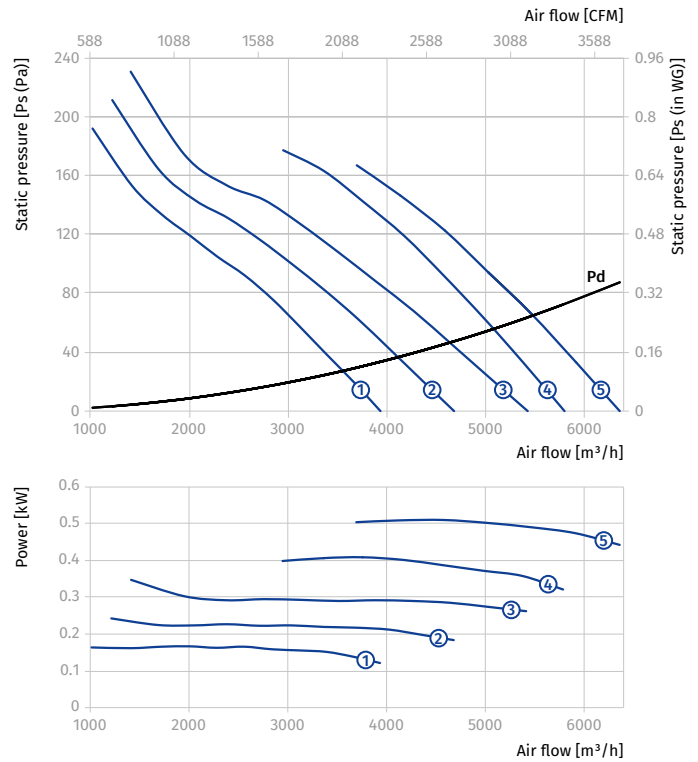

AXIAL SMOKE EXTRACTION FANS

AXIS-FP 500...400/2

Size	Number of poles	Voltage [V/60 Hz]	Fan model	Installed motor power Ny [kW]	RPM [min ⁻¹]	Number of blades	Blade setting angle [°]	Weight [kg]	Length L [mm]	Curve number on graph
Axis-FP 500-2D...400/2										
500	2	3~400	Axis-FP 500-2D/2.2-4/20/AL	2.2	3456	4	20	38	400	①
			Axis-FP 500-2D/3-4/25/AL	3	3456	4	25	43	400	②
			Axis-FP 500-2D/3.7-4/30/AL	3.7	3456	4	30	56	500	③
			Axis-FP 500-2D/4.5-4/35/AL	4.5	3456	4	35	61	500	④
			Axis-FP 500-2D/5.5-4/40/AL	5.5	3456	4	40	75	550	⑤
Axis-FP 500-4D...400/2										
500	4	3~400	Axis-FP 500-4D/0.37-4/20/AL	0.37	1728	4	20	28.5	400	①
			Axis-FP 500-4D/0.37-4/25/AL	0.37	1728	4	25	28.5	400	②
			Axis-FP 500-4D/0.55-4/30/AL	0.55	1728	4	30	29.5	400	③
			Axis-FP 500-4D/0.55-4/35/AL	0.55	1728	4	35	29.5	400	④
			Axis-FP 500-4D/0.75-4/40/AL	0.75	1728	4	40	33	400	⑤
			Axis-FP 500-4D/1.1-6/40/AL	1.1	1728	6	40	34	400	⑥

Standard size: 500
Number of poles: 2
Fire resistance rating: 400/2

Standard size: 500
Number of poles: 4
Fire resistance rating: 400/2

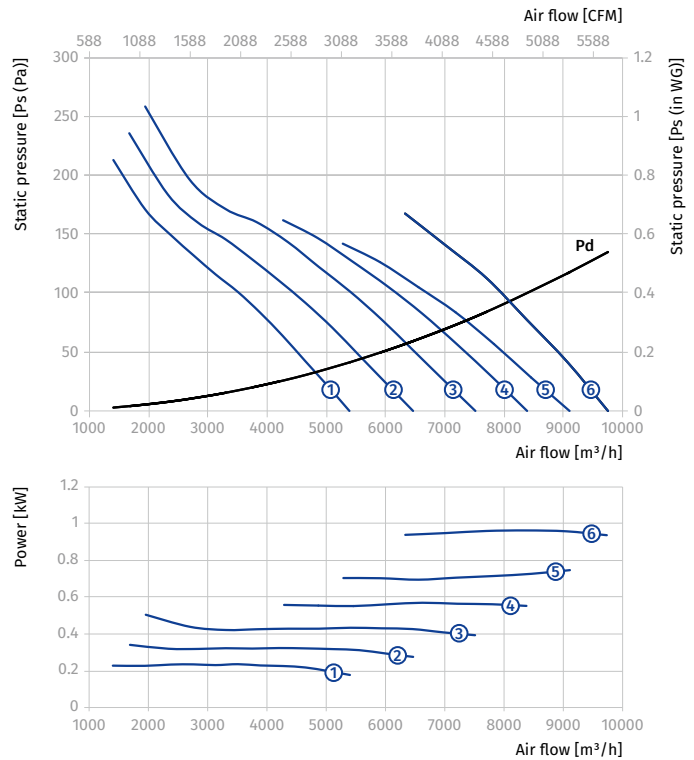
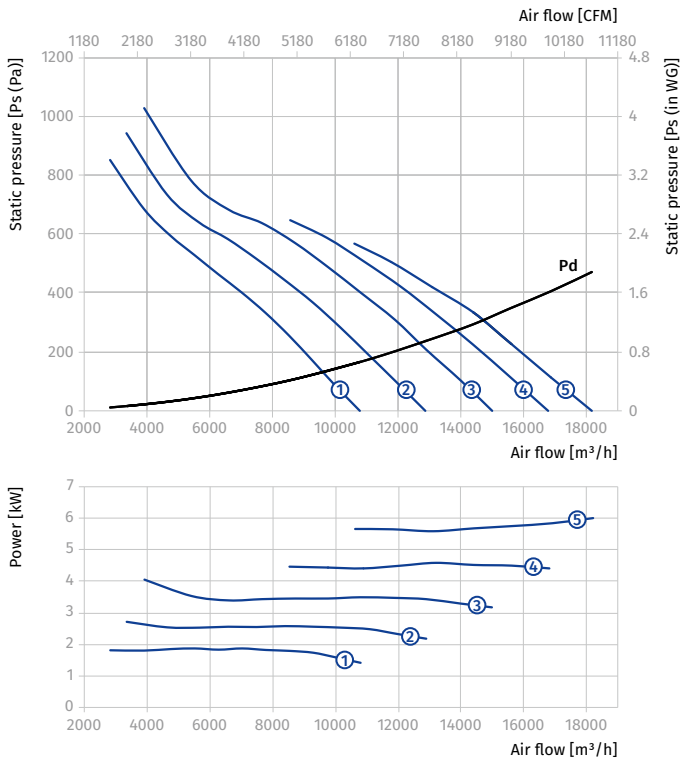

AXIS-FP 500...400/2

Size	Number of poles	Voltage [V/60 Hz]	Fan model	Installed motor power N_y [kW]	RPM [min^{-1}]	Number of blades	Blade setting angle [°]	Weight [kg]	Length L [mm]	Curve number on graph
Axis-FP 500-2/4D...400/2										
500	2/4	3~400	Axis-FP 500-2/4D/2.5/0.65-4/20/AL	2.5/0.65	3456/1728	4	20	54	500	①
			Axis-FP 500-2/4D/3.1/0.8-4/25/AL	3.1/0.8	3456/1728	4	25	55	500	②
			Axis-FP 500-2/4D/4.4/1.1-4/30/AL	4.4/1.1	3456/1728	4	30	67	500	③
			Axis-FP 500-2/4D/4.4/1.1-4/35/AL	4.4/1.1	3456/1728	4	35	67	500	④
			Axis-FP 500-2/4D/6/1.5-4/40/AL	6/1.5	3456/1728	4	40	86	550	⑤

Standard size: 500
 Number of poles: 2
 Fire resistance rating: 400/2

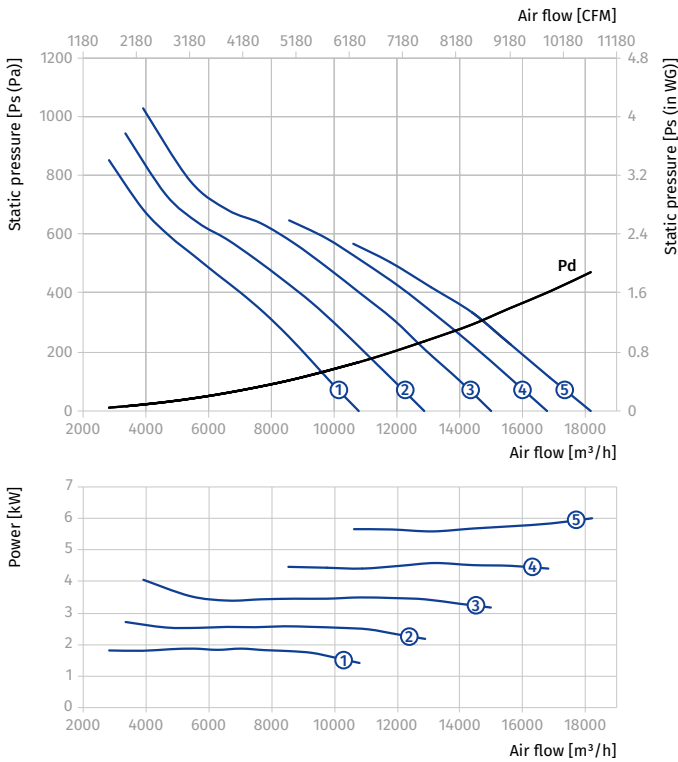

Standard size: 500
 Number of poles: 4
 Fire resistance rating: 400/2

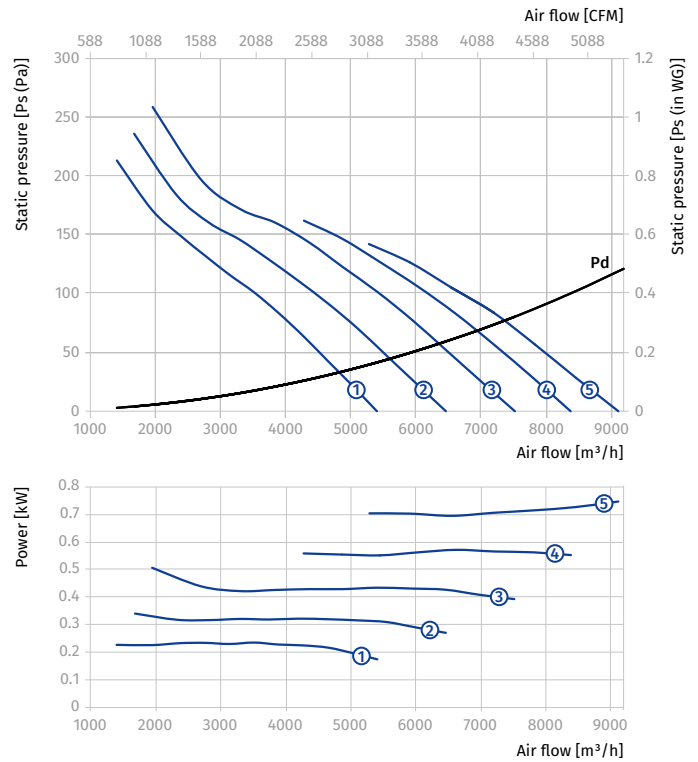

AXIS-FP 560...400/2

Size	Number of poles	Voltage [V/60 Hz]	Fan model	Installed motor power Ny [kW]	RPM [min ⁻¹]	Number of blades	Blade setting angle [°]	Weight [kg]	Length L [mm]	Curve number on graph
Axis-FP 560-2D...400/2										
560	2	3~400	Axis-FP 560-2D/3-4/20/AL	3	3456	4	20	45.5	400	①
			Axis-FP 560-2D/3.7-4/25/AL	3.7	3456	4	25	58.5	500	②
			Axis-FP 560-2D/5.5-4/30/AL	5.5	3456	4	30	86	550	③
			Axis-FP 560-2D/7.5-6/30/AL	7.5	3456	6	30	103.5	550	④
Axis-FP 560-4D...400/2										
560	4	3~400	Axis-FP 560-4D/0.37-4/20/AL	0.37	1728	4	20	30.5	400	①
			Axis-FP 560-4D/0.55-4/25/AL	0.55	1728	4	25	31.5	400	②
			Axis-FP 560-4D/0.75-4/30/AL	0.75	1728	4	30	35	400	③
			Axis-FP 560-4D/1.1-6/30/AL	1.1	1728	6	30	36	400	④
			Axis-FP 560-4D/1.1-6/35/AL	1.1	1728	6	35	36	400	⑤
			Axis-FP 560-4D/1.5-6/40/AL	1.5	1728	6	40	41	400	⑥

Standard size: 560
Number of poles: 2
Fire resistance rating: 400/2

Standard size: 560
Number of poles: 4
Fire resistance rating: 400/2

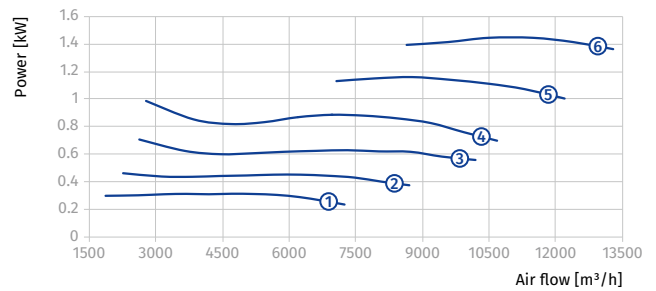
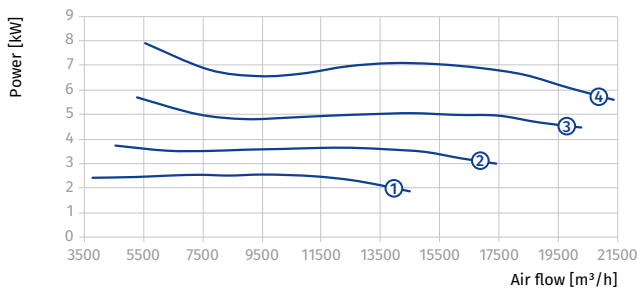
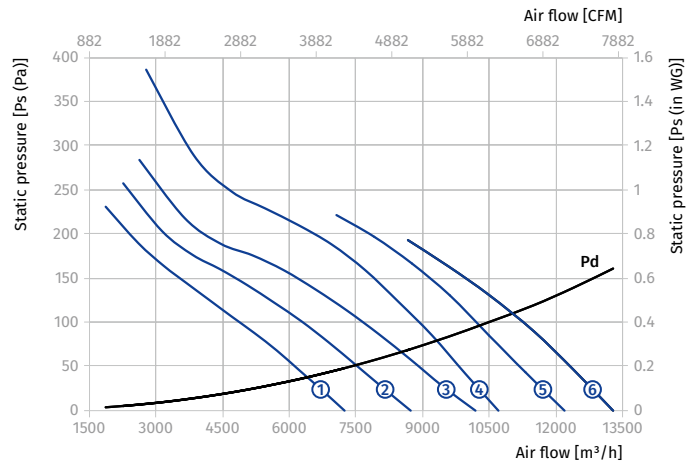
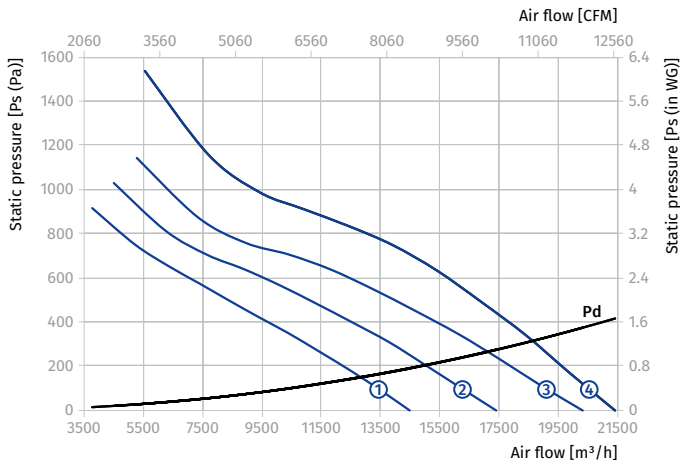

AXIS-FP 560...400/2

Size	Number of poles	Voltage [V/60 Hz]	Fan model	Installed motor power N_y [kW]	RPM [min^{-1}]	Number of blades	Blade setting angle [°]	Weight [kg]	Length L [mm]	Curve number on graph
Axis-FP 560-2/4D...400/2										
560	2/4	3~400	Axis-FP 560-2/4D/3.1/0.8-4/20/AL	3.1/0.8	3456/1728	4	20	57.5	500	①
			Axis-FP 560-2/4D/4.4/1.1-4/25/AL	4.4/1.1	3456/1728	4	25	69	500	②
			Axis-FP 560-2/4D/6/1.5-4/30/AL	6/1.5	3456/1728	4	30	97	550	③
			Axis-FP 560-2/4D/8/2-6/30/AL	8/2	3456/1728	6	30	109.5	550	④

Standard size: 560
 Number of poles: 2
 Fire resistance rating: 400/2

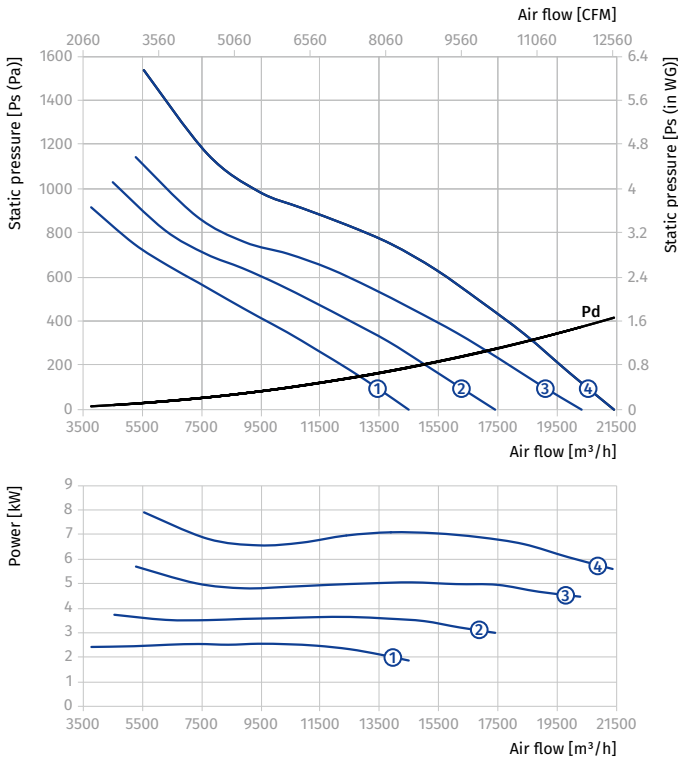

Standard size: 560
 Number of poles: 4
 Fire resistance rating: 400/2

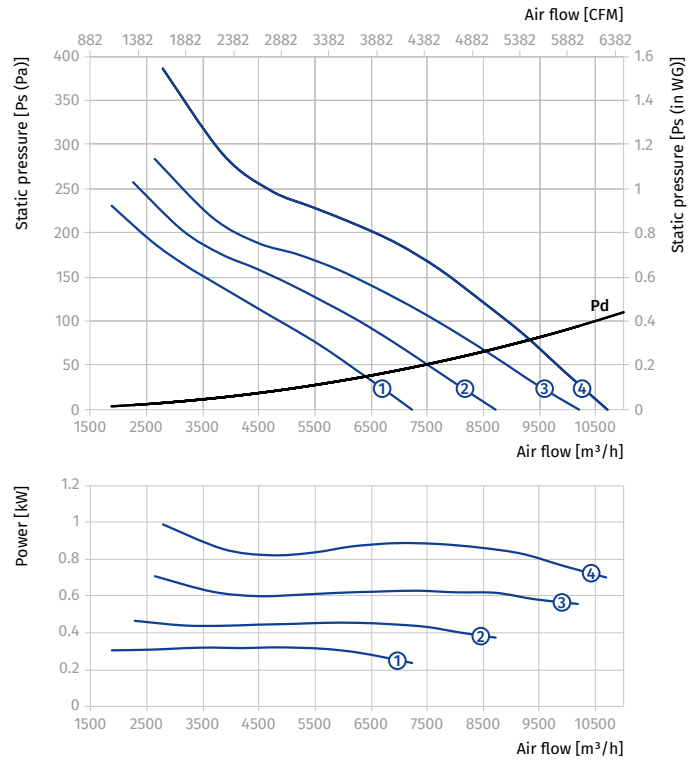

AXIS-FP 630...400/2

Size	Number of poles	Voltage [V/60 Hz]	Fan model	Installed motor power Ny [kW]	RPM [min ⁻¹]	Number of blades	Blade setting angle [°]	Weight [kg]	Length L [mm]	Curve number on graph
Axis-FP 630-2D...400/2										
630	2	3~400	Axis-FP 630-2D/5.5-6/20/AL	5.5	3456	6	20	90.5	550	①
			Axis-FP 630-2D/7.5-6/25/AL	7.5	3456	6	25	107.5	550	②
			Axis-FP 630-2D/11-6/30/AL	11	3456	6	30	115.5	550	③
			Axis-FP 630-2D/15-6/35/AL	15	3456	6	35	161	700	④
			Axis-FP 630-2D/18.5-6/40/AL	18.5	3456	6	40	169	700	⑤
Axis-FP 630-4D...400/2										
630	4	3~400	Axis-FP 630-4D/0.75-6/20/AL	0.75	1728	6	20	37.5	400	①
			Axis-FP 630-4D/1.1-6/25/AL	1.1	1728	6	25	38	400	②
			Axis-FP 630-4D/1.5-6/30/AL	1.5	1728	6	30	43	400	③
			Axis-FP 630-4D/2.2-6/35/AL	2.2	1728	6	35	46.5	400	④
			Axis-FP 630-4D/2.2-6/40/AL	2.2	1728	6	40	46.5	400	⑤
			Axis-FP 630-4D/3-9/40/AL	3	1728	9	40	63	500	⑥

Standard size: 630
Number of poles: 2
Fire resistance rating: 400/2

Standard size: 630
Number of poles: 4
Fire resistance rating: 400/2

AXIAL SMOKE EXTRACTION FANS

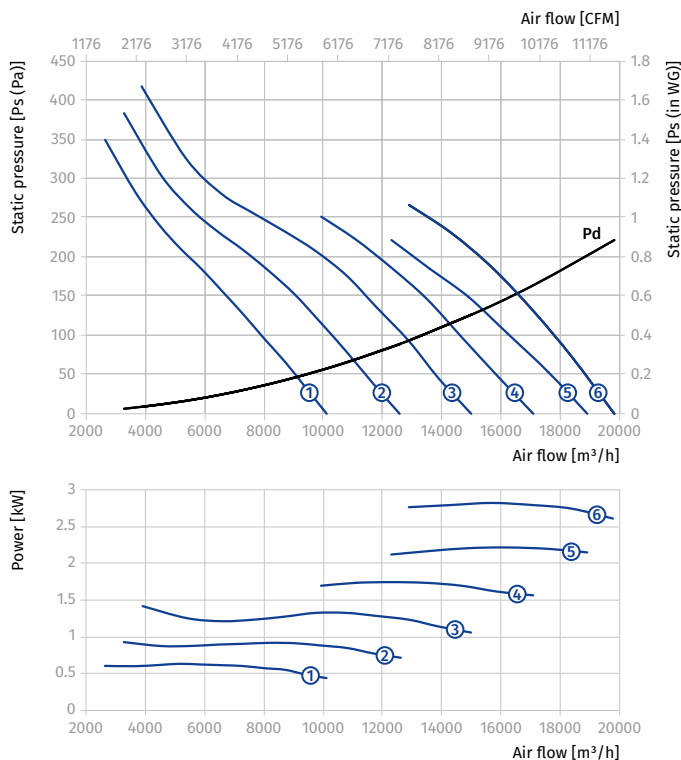
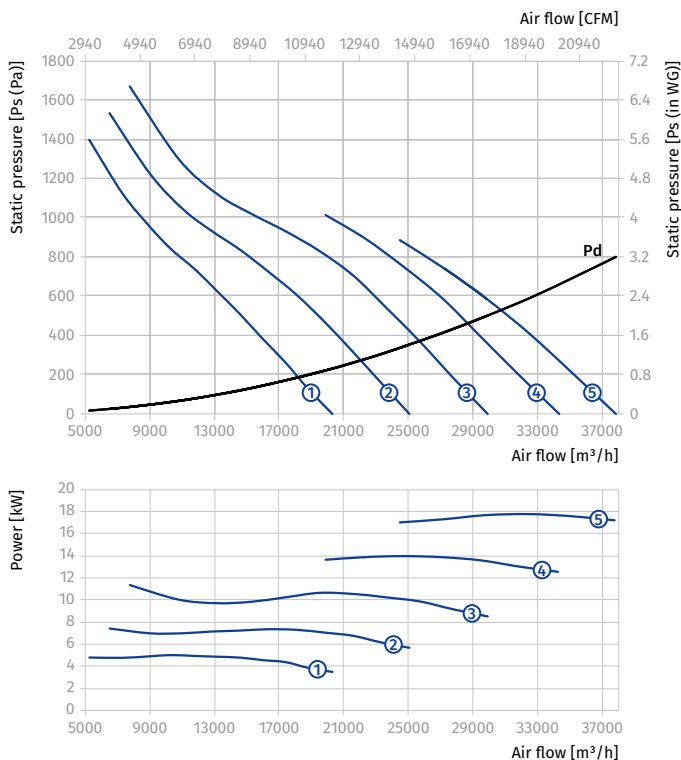

AXIS-FP 630...400/2

Size	Number of poles	Voltage [V/60 Hz]	Fan model	Installed motor power N_y [kW]	RPM [min^{-1}]	Number of blades	Blade setting angle [°]	Weight [kg]	Length L [mm]	Curve number on graph
Axis-FP 630-2/4D...400/2										
630	2/4	3~400	Axis-FP 630-2/4D/6/1.5-6/20/AL	6/1.5	3456/1728	6	20	101.5	550	①
			Axis-FP 630-2/4D/8/2-6/25/AL	8/2	3456/1728	6	25	113.5	550	②
			Axis-FP 630-2/4D/12/3-6/30/AL	12/3	3456/1728	6	30	176	700	③
			Axis-FP 630-2/4D/16/4-6/35/AL	16/4	3456/1728	6	35	192	700	④
			Axis-FP 630-2/4D/20/5.5-6/40/AL	20/5.5	3456/1728	6	40	220.5	750	⑤

Standard size: 630
 Number of poles: 2
 Fire resistance rating: 400/2

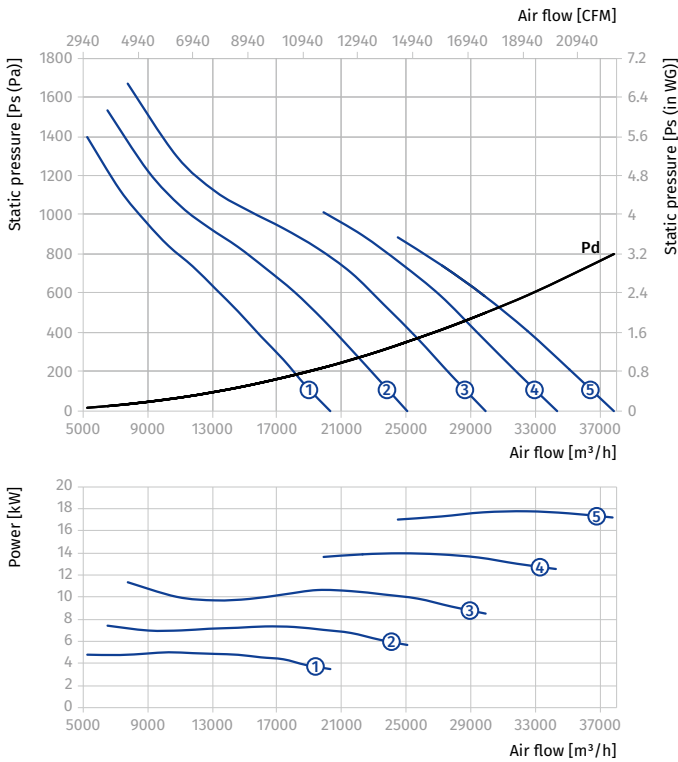

Standard size: 630
 Number of poles: 4
 Fire resistance rating: 400/2

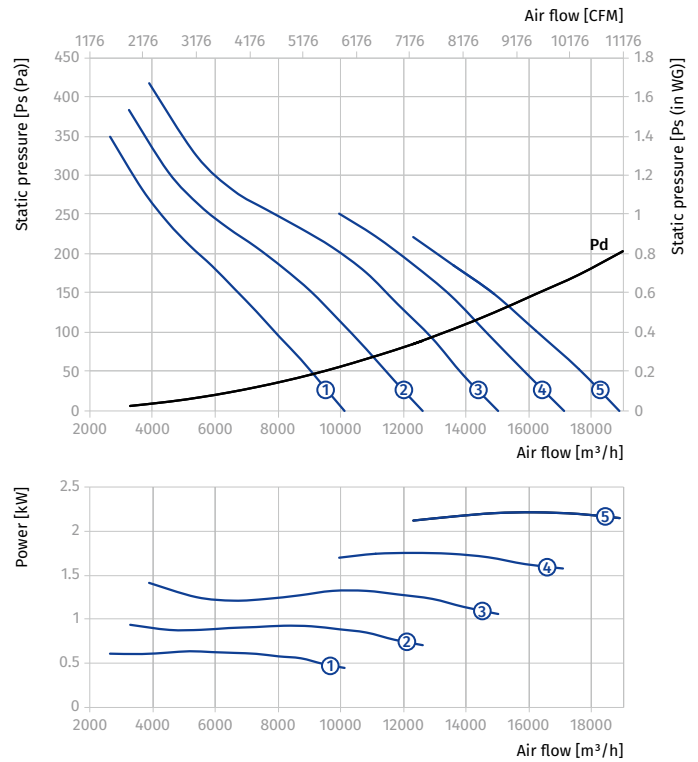

AXIS-FP 630...400/2

Size	Number of poles	Voltage [V/60 Hz]	Fan model	Installed motor power Ny [kW]	RPM [min ⁻¹]	Number of blades	Blade setting angle [°]	Weight [kg]	Length L [mm]	Curve number on graph
Axis-FP 630-4/6D...400/2										
630	4/6	3~400	Axis-FP 630-4/6D/1.1/0.3-6/20/AL	1.1/0.3	1728/1152	6	20	41.5	400	①
			Axis-FP 630-4/6D/1.1/0.3-6/25/AL	1.1/0.3	1728/1152	6	25	41.5	400	②
			Axis-FP 630-4/6D/1.5/0.37-6/30/AL	1.5/0.37	1728/1152	6	30	45.5	400	③
			Axis-FP 630-4/6D/1.7/0.6-6/35/AL	1.7/0.6	1728/1152	6	35	55	500	④
			Axis-FP 630-4/6D/3/1-6/40/AL	3/1	1728/1152	6	40	66	500	⑤
			Axis-FP 630-4/6D/3/1-9/40/AL	3/1	1728/1152	9	40	66.5	500	⑥

Standard size: 630
Number of poles: 4
Fire resistance rating: 400/2

Standard size: 630
Number of poles: 6
Fire resistance rating: 400/2

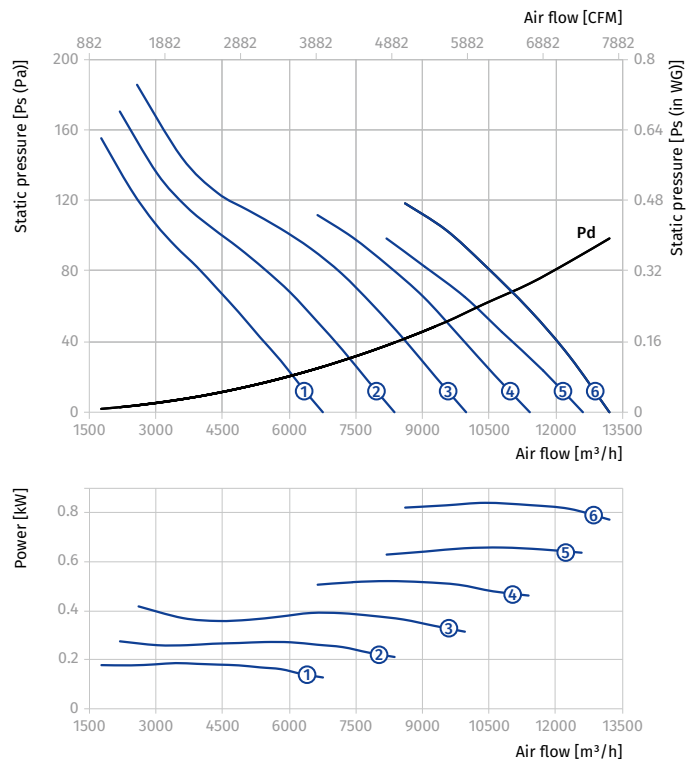
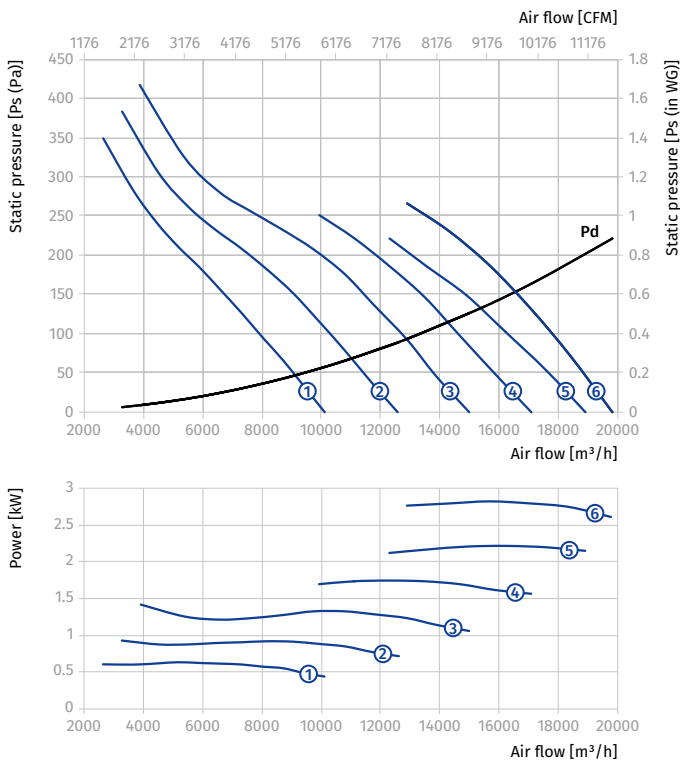

AXIS-FP 630...400/2

Size	Number of poles	Voltage [V/60 Hz]	Fan model	Installed motor power N_y [kW]	RPM [min^{-1}]	Number of blades	Blade setting angle [°]	Weight [kg]	Length L [mm]	Curve number on graph
Axis-FP 630-4/8D...400/2										
630	4/8	3~400	Axis-FP 630-4/8D/0.8/0.2-6/20/AL	0.8/0.2	1728/864	6	20	48	400	①
			Axis-FP 630-4/8D/1.2/0.3-6/25/AL	1.2/0.3	1728/864	6	25	45.5	400	②
			Axis-FP 630-4/8D/1.6/0.4-6/30/AL	1.6/0.4	1728/864	6	30	48.5	400	③
			Axis-FP 630-4/8D/2.2/0.55-6/35/AL	2.2/0.55	1728/864	6	35	60	500	④
			Axis-FP 630-4/8D/2.2/0.55-6/40/AL	2.2/0.55	1728/864	6	40	60	500	⑤
			Axis-FP 630-4/8D/2.8/0.7-9/40/AL	2.8/0.7	1728/864	9	40	64	500	⑥

Standard size: 630
 Number of poles: 4
 Fire resistance rating: 400/2

Standard size: 630
 Number of poles: 8
 Fire resistance rating: 400/2

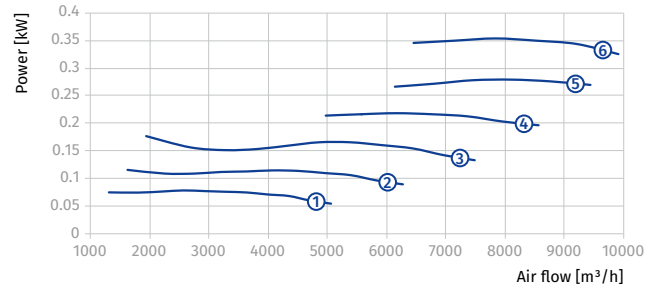
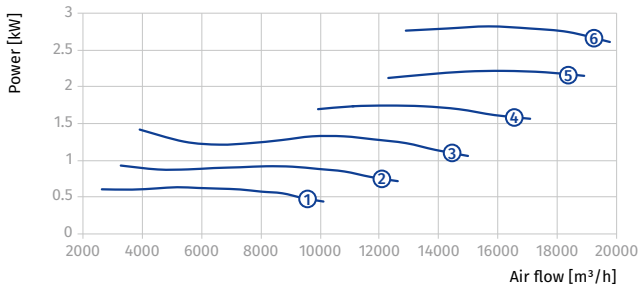
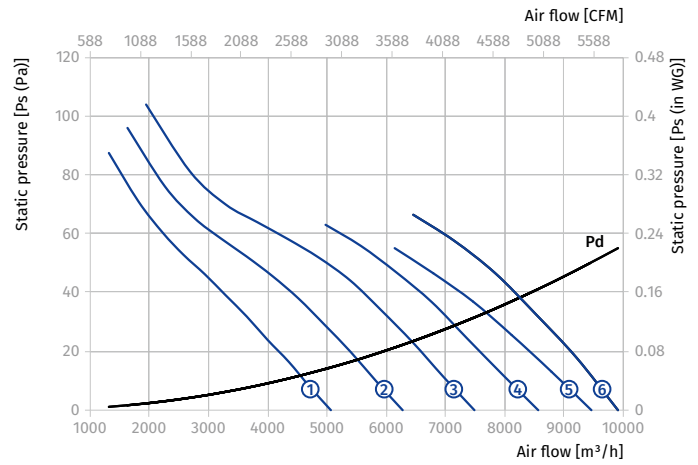
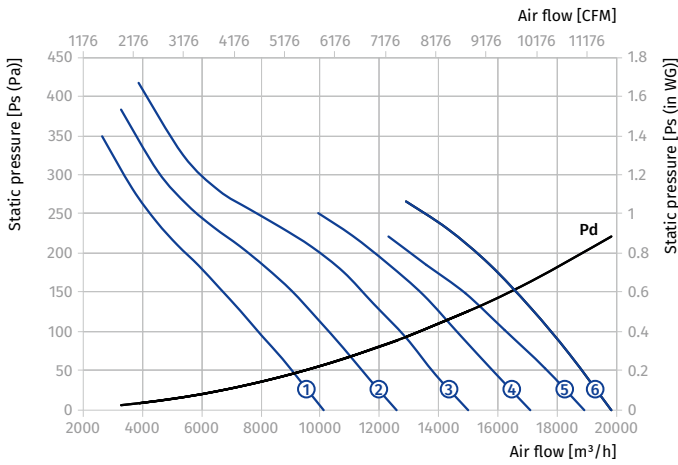

AXIS-FP 710...400/2

Size	Number of poles	Voltage [V/60 Hz]	Fan model	Installed motor power Ny [kW]	RPM [min ⁻¹]	Number of blades	Blade setting angle [°]	Weight [kg]	Length L [mm]	Curve number on graph
Axis-FP 710-4D...400/2										
710	4	3~400	Axis-FP 710-4D/0.75-6/20/AL	0.75	1728	6	20	49.5	400	①
			Axis-FP 710-4D/1.1-6/25/AL	1.1	1728	6	25	50	400	②
			Axis-FP 710-4D/1.5-6/30/AL	1.5	1728	6	30	55.5	400	③
			Axis-FP 710-4D/2.2-6/35/AL	2.2	1728	6	35	59	400	④
			Axis-FP 710-4D/3-6/40/AL	3	1728	6	40	77	500	⑤
			Axis-FP 710-4D/3.7-6/45/AL	3.7	1728	6	45	77	500	⑥
Axis-FP 710-6D...400/2										
710	6	3~400	Axis-FP 710-6D/0.25-6/20/AL	0.25	1152	6	20	45	400	①
			Axis-FP 710-6D/0.37-6/25/AL	0.37	1152	6	25	47.5	400	②
			Axis-FP 710-6D/0.55-6/30/AL	0.55	1152	6	30	51.5	400	③
			Axis-FP 710-6D/0.75-6/35/AL	0.75	1152	6	35	54.5	400	④
			Axis-FP 710-6D/0.75-6/40/AL	0.75	1152	6	40	54.5	400	⑤
			Axis-FP 710-6D/1.1-6/45/AL	1.1	1152	6	45	56	400	⑥

Standard size: 710
Number of poles: 4
Fire resistance rating: 400/2

Standard size: 710
Number of poles: 6
Fire resistance rating: 400/2

AXIAL SMOKE EXTRACTION FANS

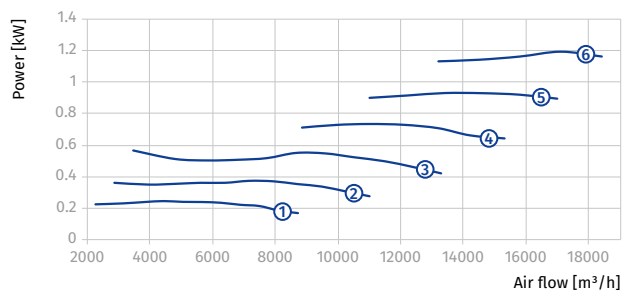
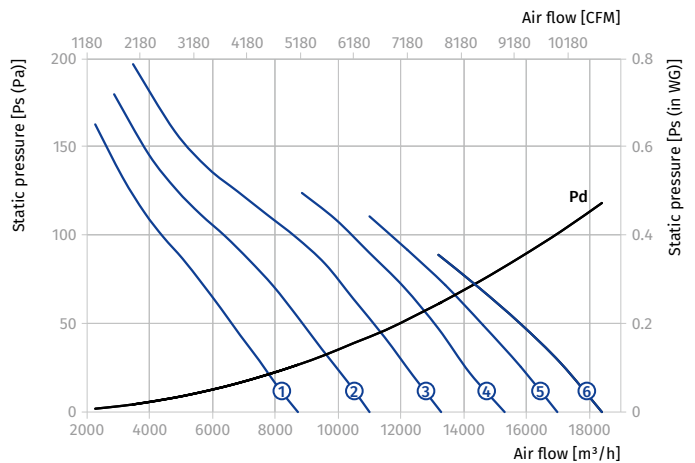
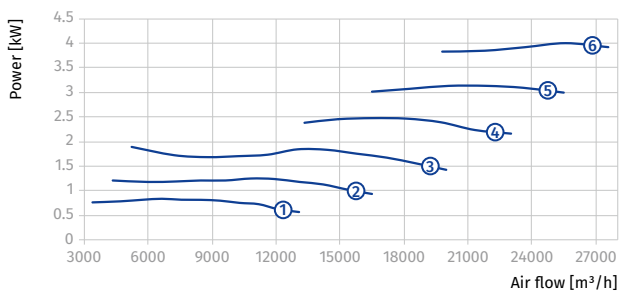
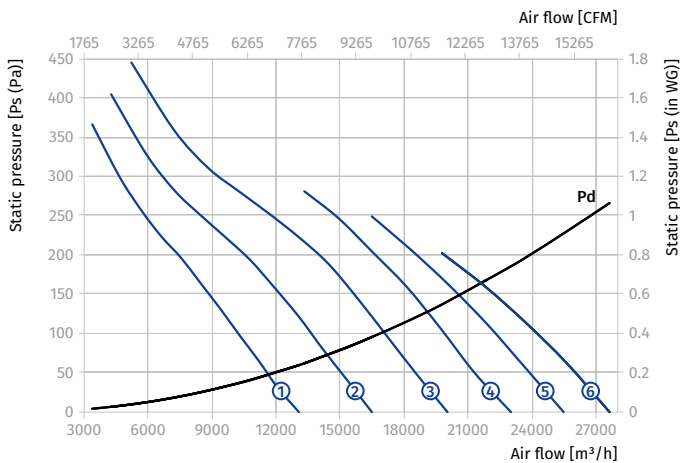

AXIS-FP 710...400/2

Size	Number of poles	Voltage [V/60 Hz]	Fan model	Installed motor power N_y [kW]	RPM [min^{-1}]	Number of blades	Blade setting angle [°]	Weight [kg]	Length L [mm]	Curve number on graph
Axis-FP 710-4/6D-2...400/2										
710	4/6	3~400	Axis-FP 710-4/6D/1.1/0.3-6/20/AL	1.1/0.3	1728/1152	6	20	54	400	①
			Axis-FP 710-4/6D/1.1/0.3-6/25/AL	1.1/0.3	1728/1152	6	25	54	400	②
			Axis-FP 710-4/6D/1.5/0.37-6/30/AL	1.5/0.37	1728/1152	6	30	58	400	③
			Axis-FP 710-4/6D/3/1-6/40/AL	3/1	1728/1152	6	40	81	500	④
			Axis-FP 710-4/6D/4.5/1.5-6/45/AL	4.5/1.5	1728/1152	6	45	116	550	⑤

Standard size: 710
 Number of poles: 4
 Fire resistance rating: 400/2

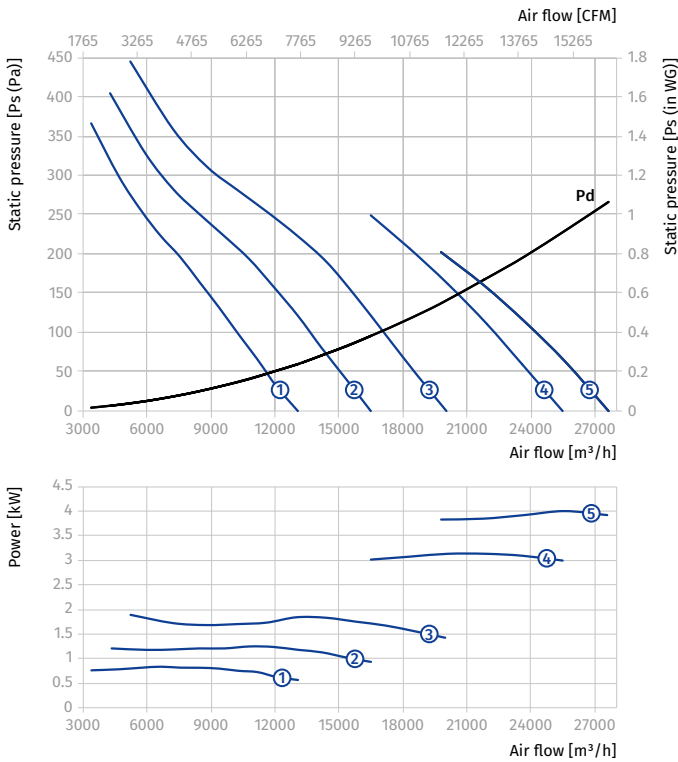

Standard size: 710
 Number of poles: 6
 Fire resistance rating: 400/2

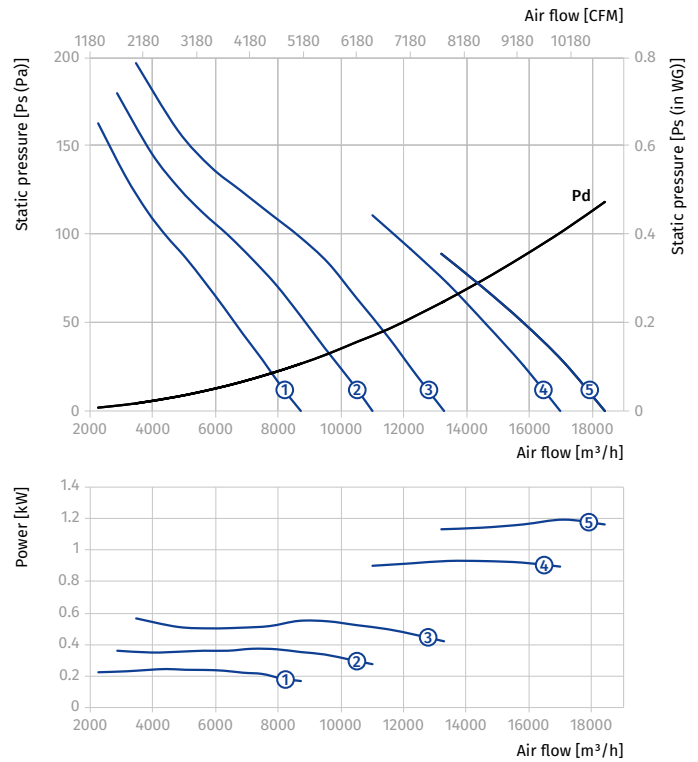

AXIAL SMOKE EXTRACTION FANS

AXIS-FP 710...400/2

Size	Number of poles	Voltage [V/60 Hz]	Fan model	Installed motor power Ny [kW]	RPM [min ⁻¹]	Number of blades	Blade setting angle [°]	Weight [kg]	Length L [mm]	Curve number on graph
Axis-FP 710-4/8D-1...400/2										
710	4/8	3~400	Axis-FP 710-4/8D/0.8/0.2-6/20/AL	0.8/0.2	1728/864	6	20	53	400	①
			Axis-FP 710-4/8D/1.2/0.3-6/25/AL	1.2/0.3	1728/864	6	25	58	400	②
			Axis-FP 710-4/8D/1.6/0.4-6/30/AL	1.6/0.4	1728/864	6	30	61	400	③
			Axis-FP 710-4/8D/2.2/0.55-6/35/AL	2.2/0.55	1728/864	6	35	75	500	④
			Axis-FP 710-4/8D/2.8/0.7-6/40/AL	2.8/0.7	1728/864	6	40	78	500	⑤
			Axis-FP 710-4/8D/3.8/1-6/45/AL	3.8/1	1728/864	6	45	87	500	⑥

Standard size: 710
Number of poles: 4
Fire resistance rating: 400/2

Standard size: 710
Number of poles: 8
Fire resistance rating: 400/2

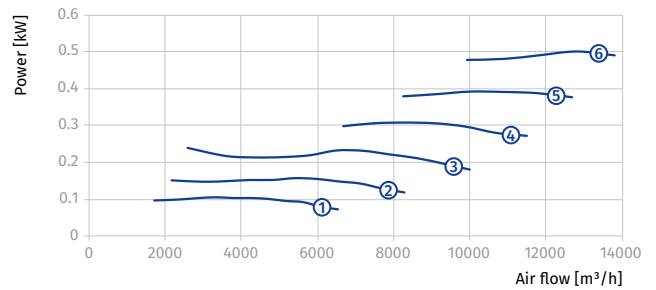
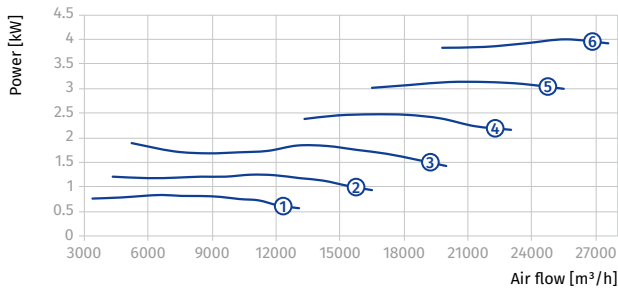
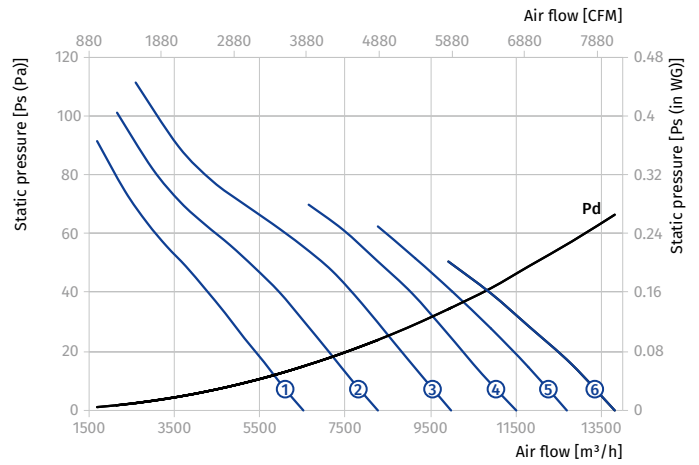
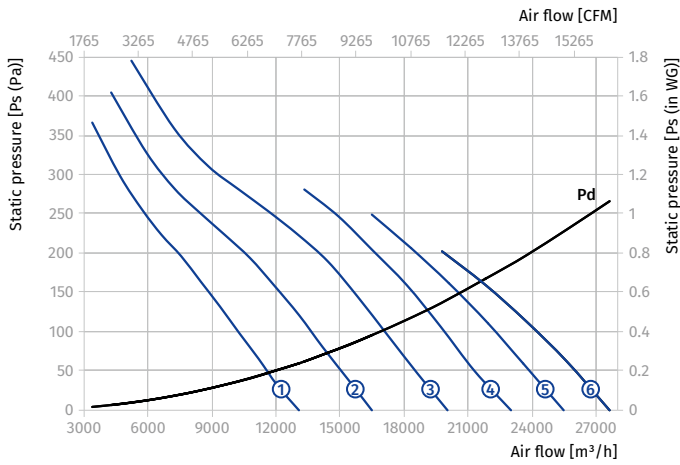

AXIAL SMOKE EXTRACTION FANS

AXIS-FP 800...400/2

Size	Number of poles	Voltage [V/60 Hz]	Fan model	Installed motor power N_y [kW]	RPM [min^{-1}]	Number of blades	Blade setting angle [°]	Weight [kg]	Length L [mm]	Curve number on graph
Axis-FP 800-4D...400/2										
800	4	3~400	Axis-FP 800-4D/1.1-6/20/AL	1.1	1728	6	20	54	400	①
			Axis-FP 800-4D/1.5-6/25/AL	1.5	1728	6	25	59.5	400	②
			Axis-FP 800-4D/2.2-6/30/AL	2.2	1728	6	30	63	400	③
			Axis-FP 800-4D/3.7-6/35/AL	3.7	1728	6	35	81.5	500	④
			Axis-FP 800-4D/4.5-6/40/AL	4.5	1728	6	40	74	500	⑤
			Axis-FP 800-4D/5.5-6/45/AL	5.5	1728	6	45	93.5	500	⑥
Axis-FP 800-6D...400/2										
800	6	3~400	Axis-FP 800-6D/0.37-6/20/AL	0.37	1152	6	20	51.5	400	①
			Axis-FP 800-6D/0.55-6/25/AL	0.55	1152	6	25	55.5	400	②
			Axis-FP 800-6D/0.75-6/30/AL	0.75	1152	6	30	58.5	400	③
			Axis-FP 800-6D/1.1-6/35/AL	1.1	1152	6	35	60	400	④
			Axis-FP 800-6D/1.1-6/40/AL	1.1	1152	6	40	60	400	⑤

Standard size: 800
 Number of poles: 4
 Fire resistance rating: 400/2

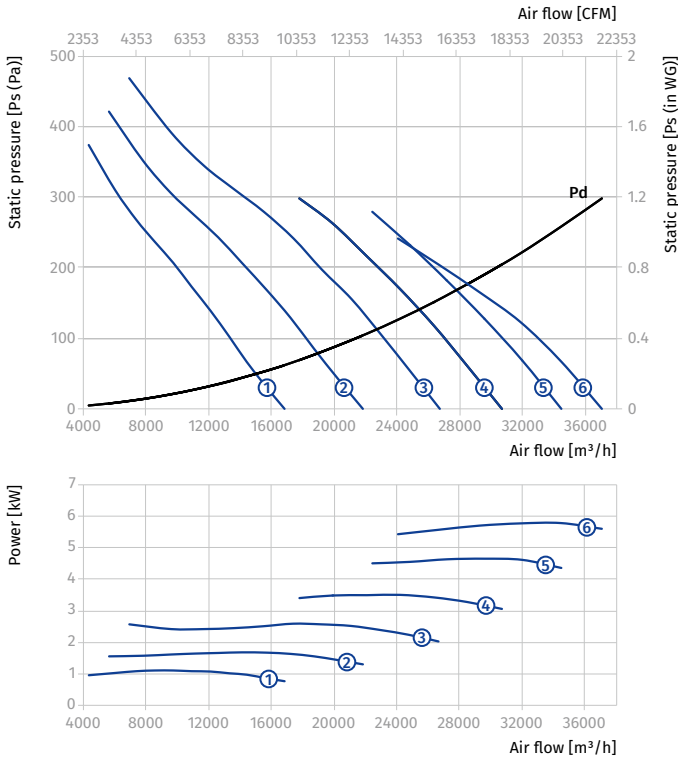

Standard size: 800
 Number of poles: 6
 Fire resistance rating: 400/2

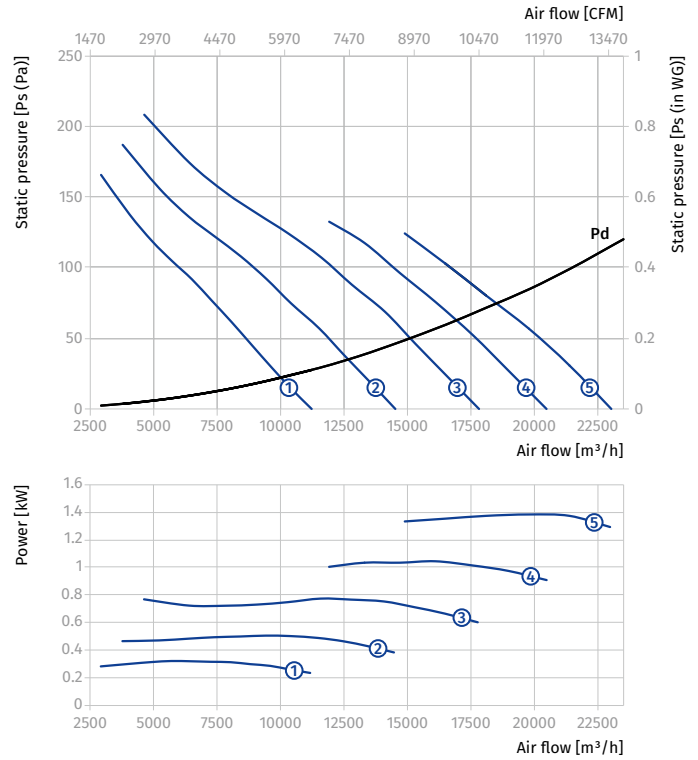

AXIAL SMOKE EXTRACTION FANS

AXIS-FP 800...400/2

Size	Number of poles	Voltage [V/60 Hz]	Fan model	Installed motor power Ny [kW]	RPM [min ⁻¹]	Number of blades	Blade setting angle [°]	Weight [kg]	Length L [mm]	Curve number on graph
Axis-FP 800-4/6D-1...400/2										
800	4/6	3~400	Axis-FP 800-4/6D/1.1/0.3-6/20/AL	1.1/0.3	1728/1152	6	20	58	400	①
			Axis-FP 800-4/6D/1.5/0.37-6/25/AL	1.5/0.37	1728/1152	6	25	62	400	②
			Axis-FP 800-4/6D/3/1-6/30/AL	3/1	1728/1152	6	30	87.5	500	③
			Axis-FP 800-4/6D/4.5/1.5-6/40/AL	4.5/1.5	1728/1152	6	40	124	550	④
			Axis-FP 800-4/6D/6/2.2-6/45/AL	6/2.2	1728/1152	6	45	136	550	⑤

Standard size: **800**
Number of poles: **4**
Fire resistance rating: **400/2**

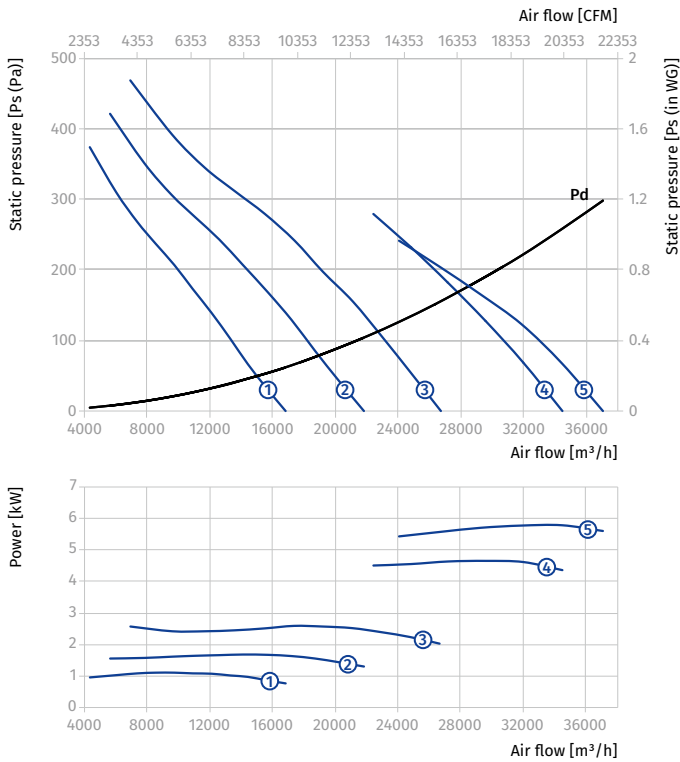

Standard size: **800**
Number of poles: **6**
Fire resistance rating: **400/2**

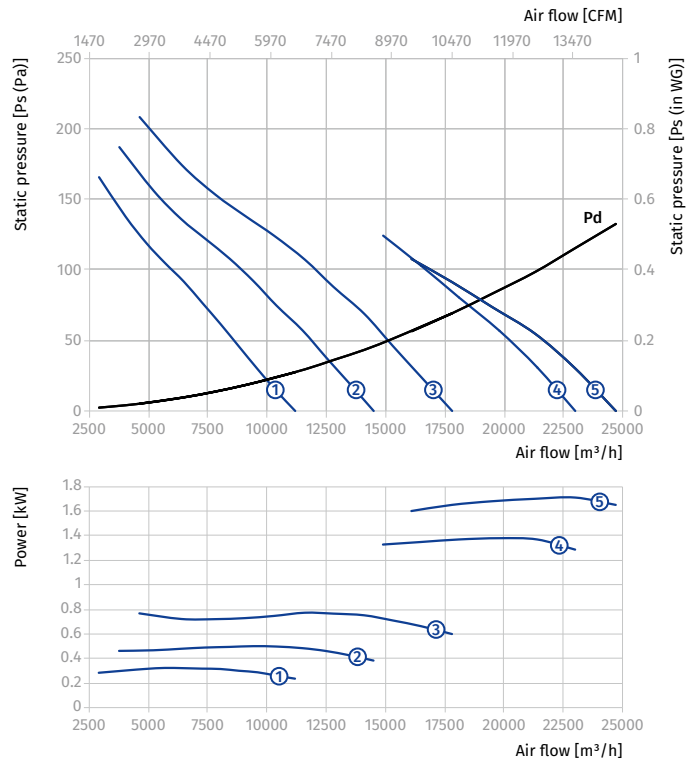

AXIS-FP 800...400/2

Size	Number of poles	Voltage [V/60 Hz]	Fan model	Installed motor power N_y [kW]	RPM [min^{-1}]	Number of blades	Blade setting angle [°]	Weight [kg]	Length L [mm]	Curve number on graph
Axis-FP 800-4/8D...400/2										
800	4/8	3~400	Axis-FP 800-4/8D/1.2/0.3-6/20/AL	1.2/0.3	1728/864	6	20	62	400	①
			Axis-FP 800-4/8D/1.6/0.4-6/25/AL	1.6/0.4	1728/864	6	25	65	400	②
			Axis-FP 800-4/8D/2.2/0.55-6/30/AL	2.2/0.55	1728/864	6	30	79.5	500	③
			Axis-FP 800-4/8D/3.8/1-6/35/AL	3.8/1	1728/864	6	35	93.5	500	④
			Axis-FP 800-4/8D/5/1.3-6/40/AL	5/1.3	1728/864	6	40	124	550	⑤

Standard size: 800
 Number of poles: 4
 Fire resistance rating: 400/2

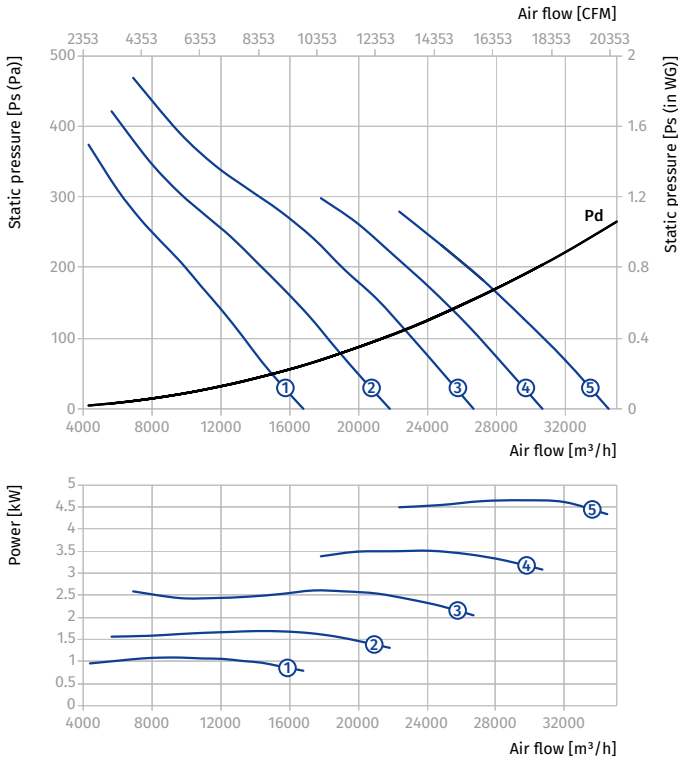

Standard size: 800
 Number of poles: 8
 Fire resistance rating: 400/2

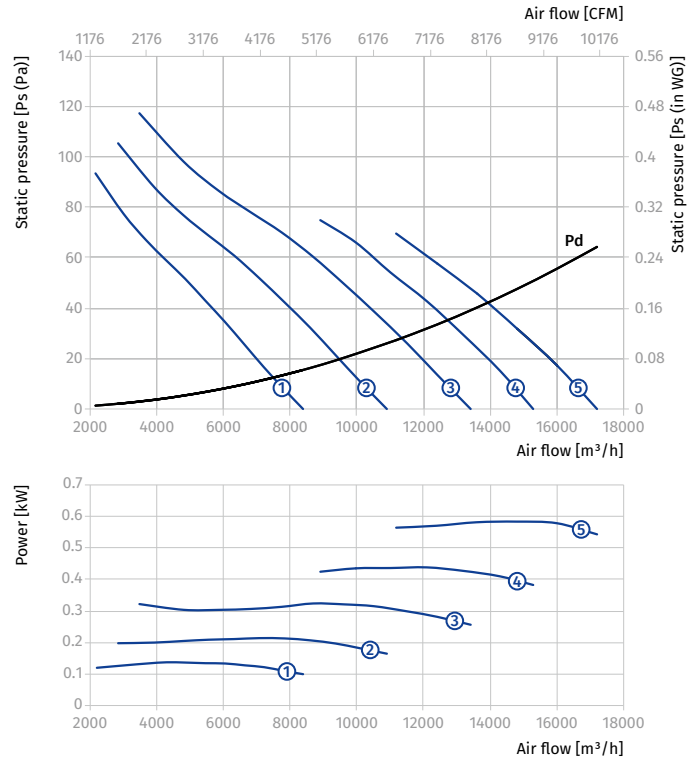

AXIAL SMOKE EXTRACTION FANS

AXIS-FP 900...400/2

Size	Number of poles	Voltage [V/60 Hz]	Fan model	Installed motor power Ny [kW]	RPM [min ⁻¹]	Number of blades	Blade setting angle [°]	Weight [kg]	Length L [mm]	Curve number on graph
Axis-FP 900-4D...400/2										
900	4	3~400	Axis-FP 900-4D/3-3/20/AL	3	1728	3	20	100	550	①
			Axis-FP 900-4D/4.5-3/26/AL	4.5	1728	3	26	92	550	②
			Axis-FP 900-4D/5.5-3/29/AL	5.5	1728	3	29	112	550	③
			Axis-FP 900-4D/7.5-3/35/AL	7.5	1728	3	35	158.5	600	④
			Axis-FP 900-4D/9.2-3/39/AL	9.2	1728	3	39	160.5	600	⑤
			Axis-FP 900-4D/11-3/43/AL	11	1728	3	43	163.5	600	⑥
Axis-FP 900-6D...400/2										
900	6	3~400	Axis-FP 900-6D/0.75-3/20/AL	0.75	1152	3	20	75.5	450	①
			Axis-FP 900-6D/1.1-3/25/AL	1.1	1152	3	25	77	450	②
			Axis-FP 900-6D/1.5-3/30/AL	1.5	1152	3	30	104	550	③
			Axis-FP 900-6D/2.2-3/36/AL	2.2	1152	3	36	95.5	550	④
			Axis-FP 900-6D/3-3/42/AL	3	1152	3	42	108	550	⑤

Standard size: 900
Number of poles: 4
Fire resistance rating: 400/2

Standard size: 900
Number of poles: 6
Fire resistance rating: 400/2

AXIAL SMOKE EXTRACTION FANS

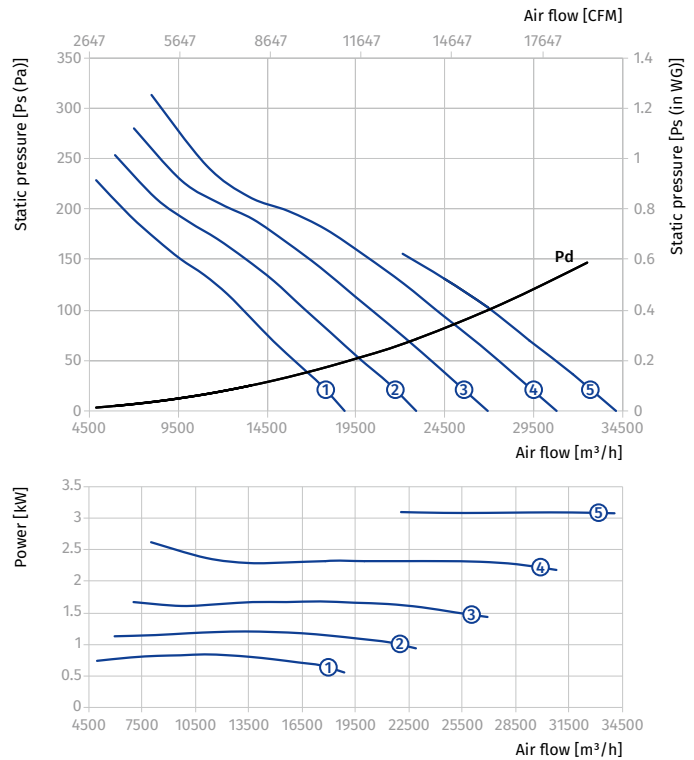
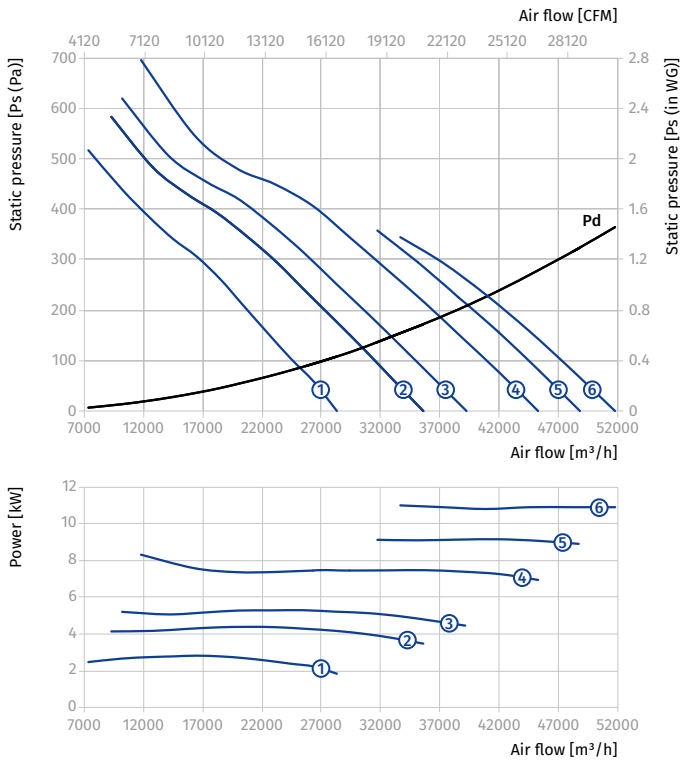

AXIS-FP 900...400/2

Size	Number of poles	Voltage [V/60 Hz]	Fan model	Installed motor power Ny [kW]	RPM [min ⁻¹]	Number of blades	Blade setting angle [°]	Weight [kg]	Length L [mm]	Curve number on graph
Axis-FP 900-4/6D...400/2										
900	4/6	3~400	Axis-FP 900-4/6D/3/1-3/20/AL	3/1	1728/1152	3	20	106	550	①
			Axis-FP 900-4/6D/4.5/1.5-3/26/AL	4.5/1.5	1728/1152	3	26	158.5	600	②
			Axis-FP 900-4/6D/6/2.2-3/31/AL	6/2.2	1728/1152	3	31	170.5	600	③
			Axis-FP 900-4/6D/10/3.3-3/41/AL	10/3.3	1728/1152	3	41	232.5	750	④

Standard size: 900
Number of poles: 4
Fire resistance rating: 400/2

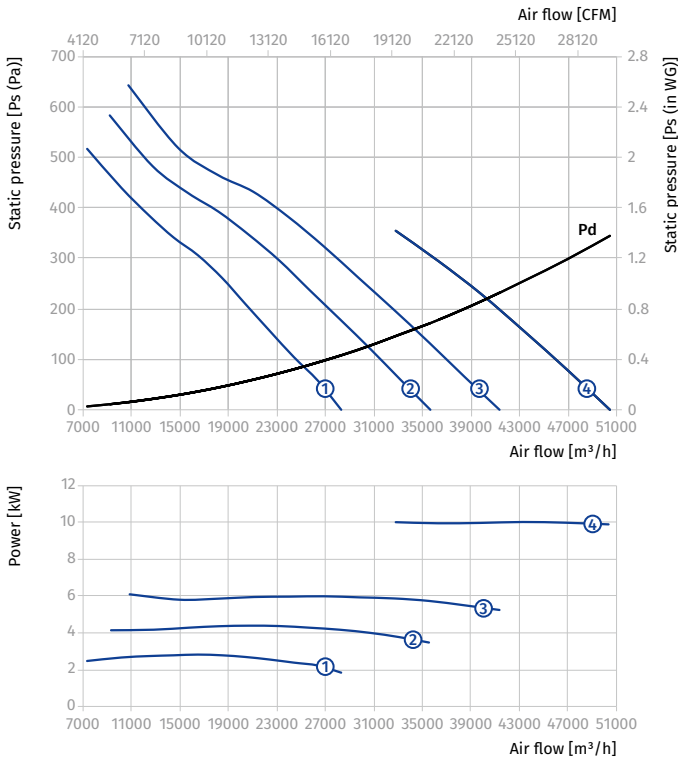

Standard size: 900
Number of poles: 6
Fire resistance rating: 400/2

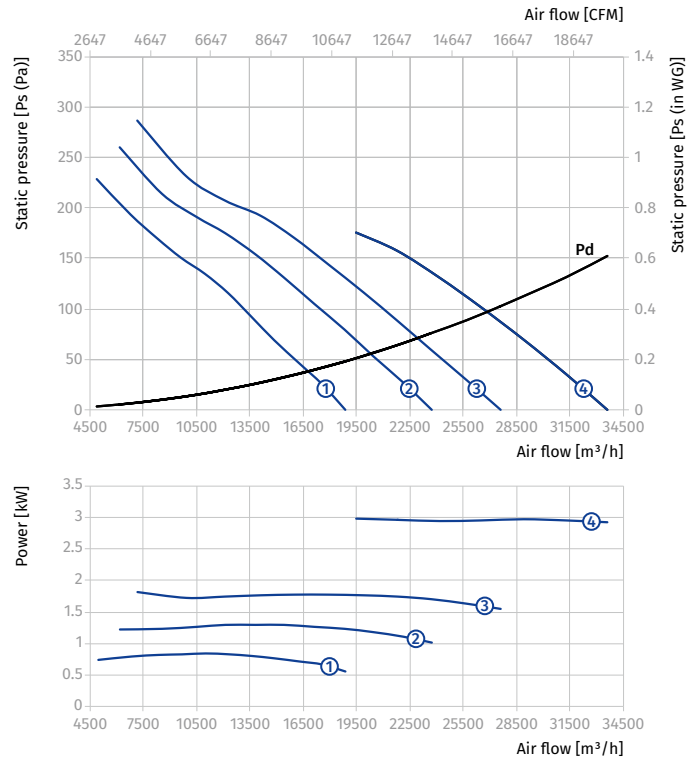

AXIAL SMOKE EXTRACTION FANS

AXIS-FP 900...400/2

Size	Number of poles	Voltage [V/60 Hz]	Fan model	Installed motor power Ny [kW]	RPM [min ⁻¹]	Number of blades	Blade setting angle [°]	Weight [kg]	Length L [mm]	Curve number on graph
Axis-FP 900-4/8D...400/2										
900	4/8	3~400	Axis-FP 900-4/8D/2.8/0.7-3/20/AL	2.8/0.7	1728/864	3	20	100.5	550	①
			Axis-FP 900-4/8D/3.8/1-3/24/AL	3.8/1	1728/864	3	24	112	550	②
			Axis-FP 900-4/8D/5/1.3-3/28/AL	5/1.3	1728/864	3	28	158.5	600	③
			Axis-FP 900-4/8D/7.2/1.8-3/34/AL	7.2/1.8	1728/864	3	34	170.5	600	④
			Axis-FP 900-4/8D/11/3-3/43/AL	11/3	1728/864	3	43	231.5	750	⑤

Standard size: **900**
Number of poles: **4**
Fire resistance rating: **400/2**

Standard size: **900**
Number of poles: **8**
Fire resistance rating: **400/2**

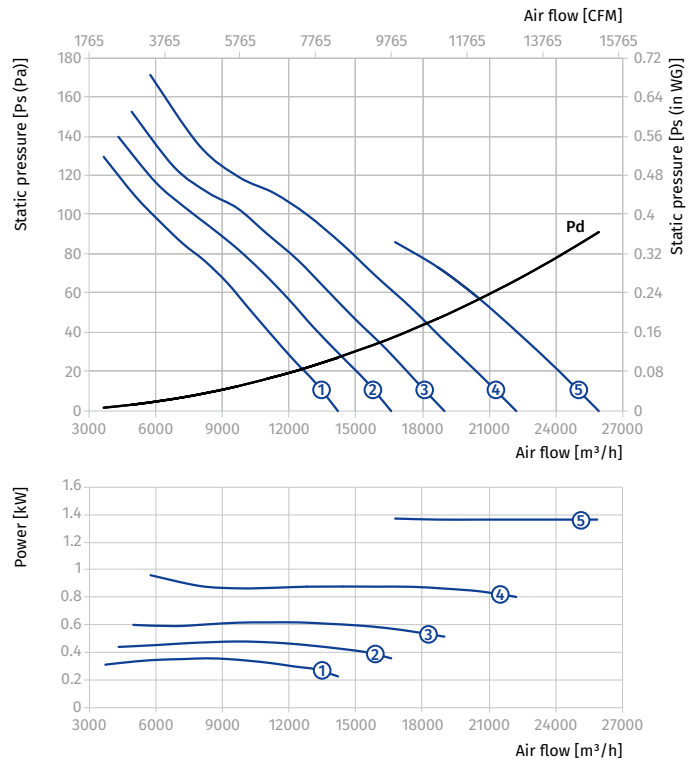
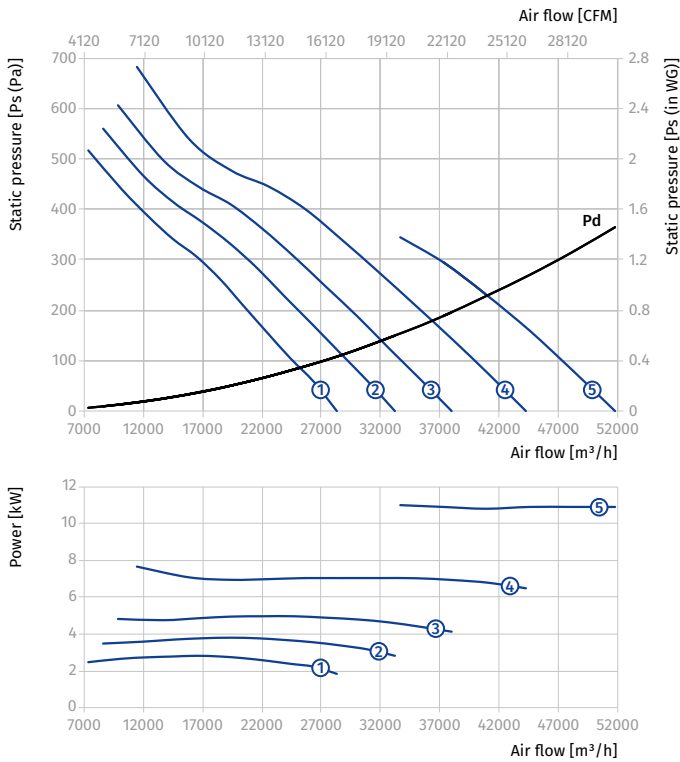

AXIS-FP 1000...400/2

Size	Number of poles	Voltage [V/60 Hz]	Fan model	Installed motor power N_y [kW]	RPM [min^{-1}]	Number of blades	Blade setting angle [°]	Weight [kg]	Length L [mm]	Curve number on graph
Axis-FP 1000-4D...400/2										
1000	4	3~400	Axis-FP 1000-4D/5.5-5/20/AL	5.5	1728	5	20	120.5	550	①
			Axis-FP 1000-4D/7.5-5/24/AL	7.5	1728	5	24	169	600	②
			Axis-FP 1000-4D/9.2-5/27/AL	9.2	1728	5	27	171	600	③
			Axis-FP 1000-4D/11-5/30/AL	11	1728	5	30	174	600	④
			Axis-FP 1000-4D/15-5/34/AL	15	1728	5	34	230	750	⑤
			Axis-FP 1000-4D/18.5-5/38/AL	18.5	1728	5	38	247	750	⑥
Axis-FP 1000-6D...400/2										
1000	6	3~400	Axis-FP 1000-6D/1.5-5/20/AL	1.5	1152	5	20	112.5	550	①
			Axis-FP 1000-6D/2.2-5/24/AL	2.2	1152	5	24	104	550	②
			Axis-FP 1000-6D/3-5/29/AL	3	1152	5	29	116.5	550	③
			Axis-FP 1000-6D/4.5-5/33/AL	4.5	1152	5	33	160	600	④
			Axis-FP 1000-6D/5.5-5/39/AL	5.5	1152	5	39	165	600	⑤

Standard size: 1000
 Number of poles: 4
 Fire resistance rating: 400/2

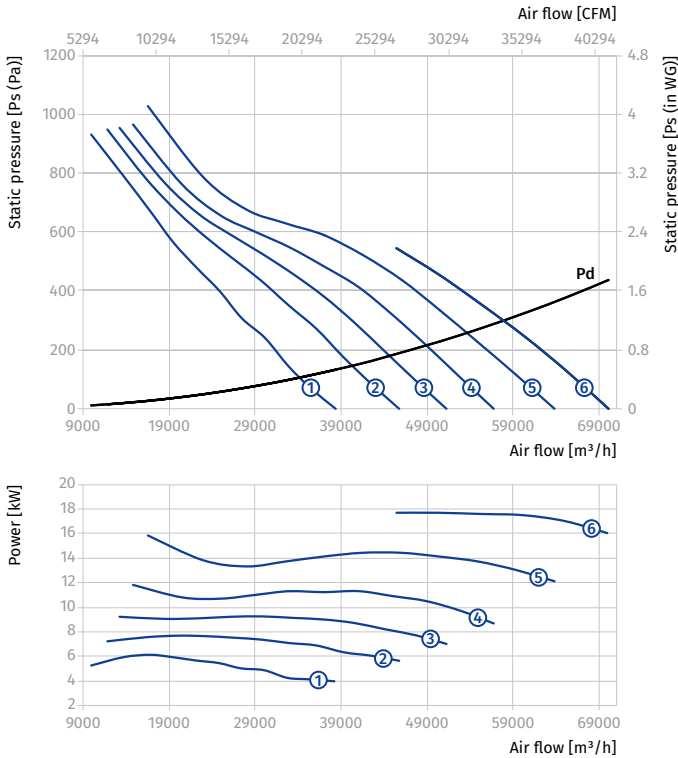

Standard size: 1000
 Number of poles: 6
 Fire resistance rating: 400/2

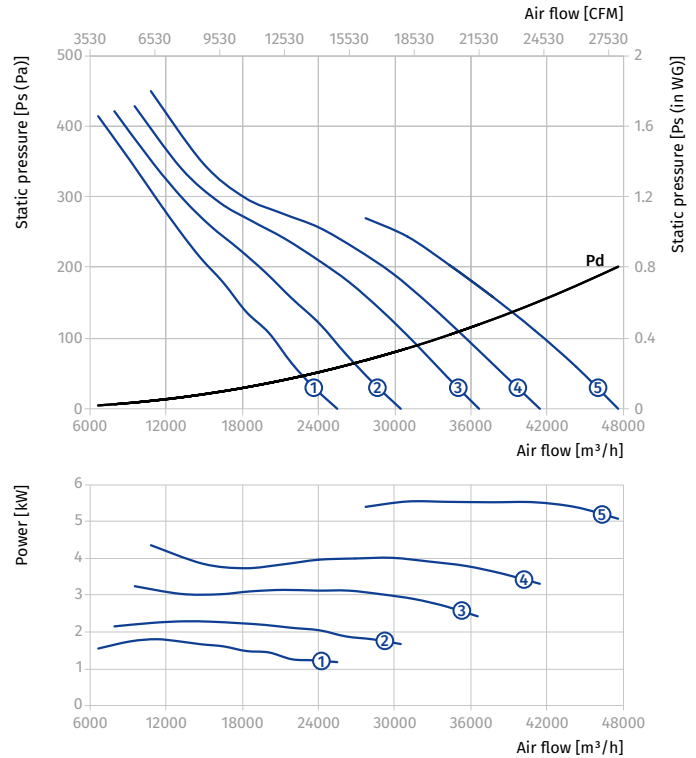

AXIAL SMOKE EXTRACTION FANS

AXIS-FP 1000...400/2

Size	Number of poles	Voltage [V/60 Hz]	Fan model	Installed motor power Ny [kW]	RPM [min ⁻¹]	Number of blades	Blade setting angle [°]	Weight [kg]	Length L [mm]	Curve number on graph
Axis-FP 1000-4/6D...400/2										
1000	4/6	3~400	Axis-FP 1000-4/6D/6/2.2-5/20/AL	6/2.2	1728/1152	5	20	181	600	①
			Axis-FP 1000-4/6D/10/3.3-5/29/AL	10/3.3	1728/1152	5	29	245	750	②
			Axis-FP 1000-4/6D/14/4.5-5/34/AL	14/4.5	1728/1152	5	34	260	750	③
			Axis-FP 1000-4/6D/16/6.5-5/37/AL	16/6.5	1728/1152	5	37	329	800	④
			Axis-FP 1000-4/6D/16/6.5-6/45/AL	16/6.5	1440/960	6	45	330.5	800	⑤

Standard size: 1000
Number of poles: 4
Fire resistance rating: 400/2

Standard size: 1000
Number of poles: 6
Fire resistance rating: 400/2

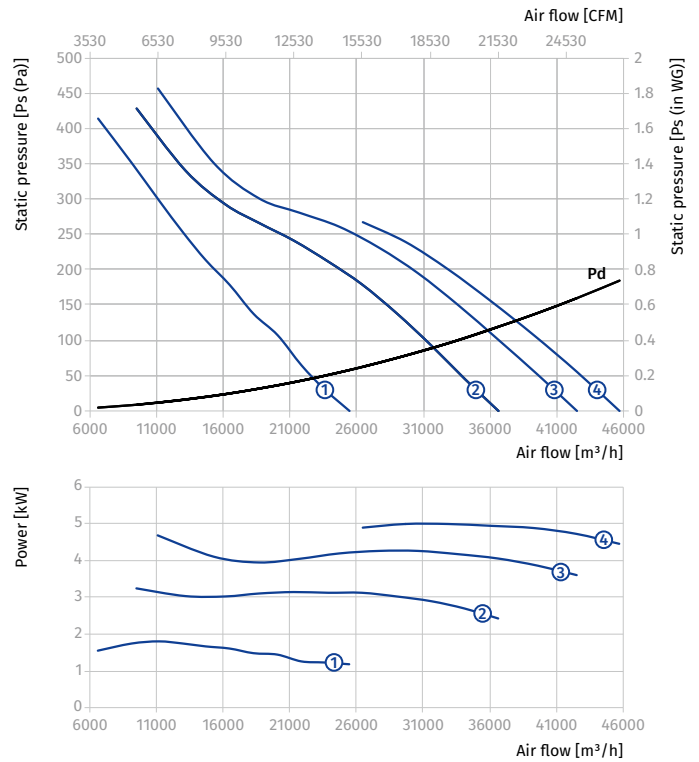
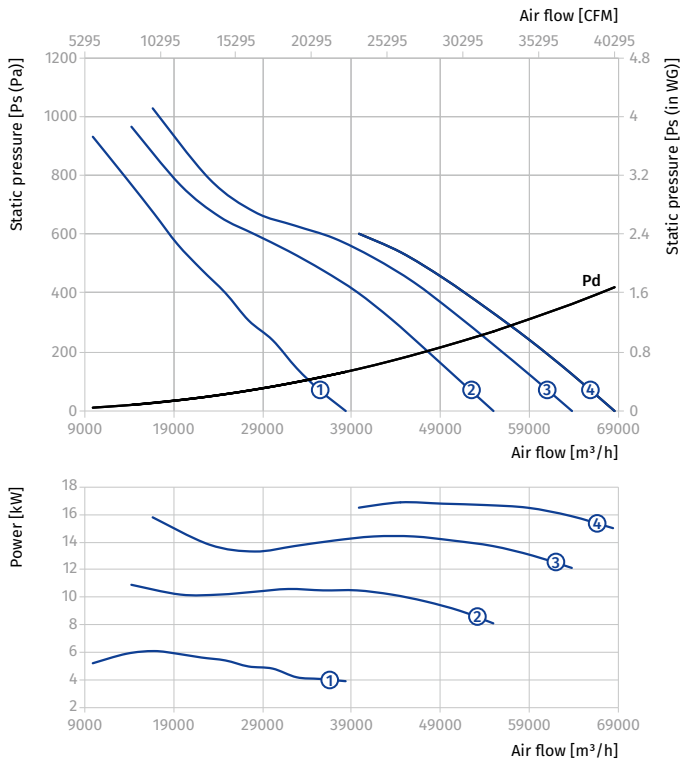

AXIS-FP 1000...400/2

Size	Number of poles	Voltage [V/60 Hz]	Fan model	Installed motor power N_y [kW]	RPM [min^{-1}]	Number of blades	Blade setting angle [°]	Weight [kg]	Length L [mm]	Curve number on graph
Axis-FP 1000-4/8D...400/2										
1000	4/8	3~400	Axis-FP 1000-4/8D/5/1.3-5/20/AL	5/1.3	1728/864	5	20	169	600	①
			Axis-FP 1000-4/8D/7.2/1.8-5/24/AL	7.2/1.8	1728/864	5	24	181	600	②
			Axis-FP 1000-4/8D/11/3-5/30/AL	11/3	1728/864	5	30	244	750	③
			Axis-FP 1000-4/8D/14/3.5-5/34/AL	14/3.5	1728/864	5	34	260	750	④
			Axis-FP 1000-4/8D/17/4.3-5/38/AL	17/4.3	1728/864	5	38	296	800	⑤

Standard size: 1000
 Number of poles: 4
 Fire resistance rating: 400/2

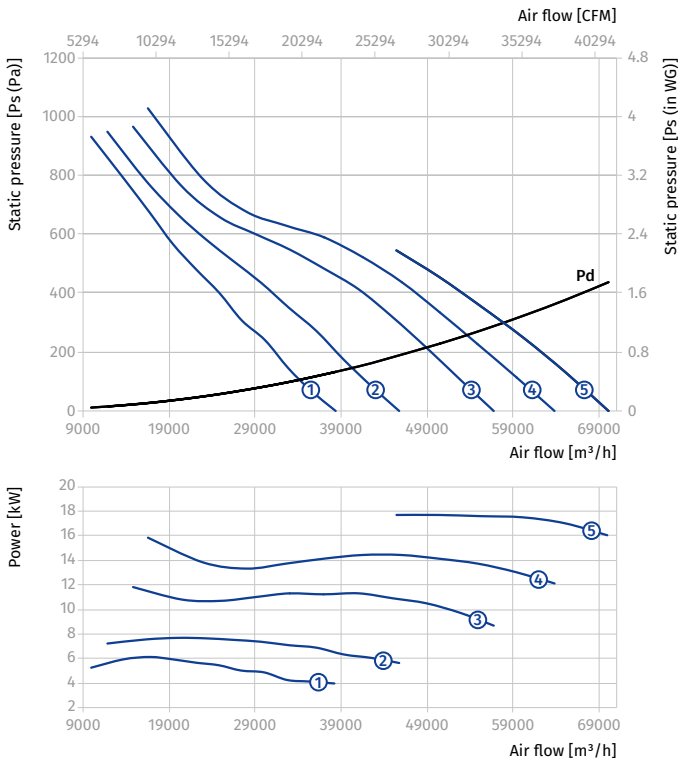

Standard size: 1000
 Number of poles: 8
 Fire resistance rating: 400/2

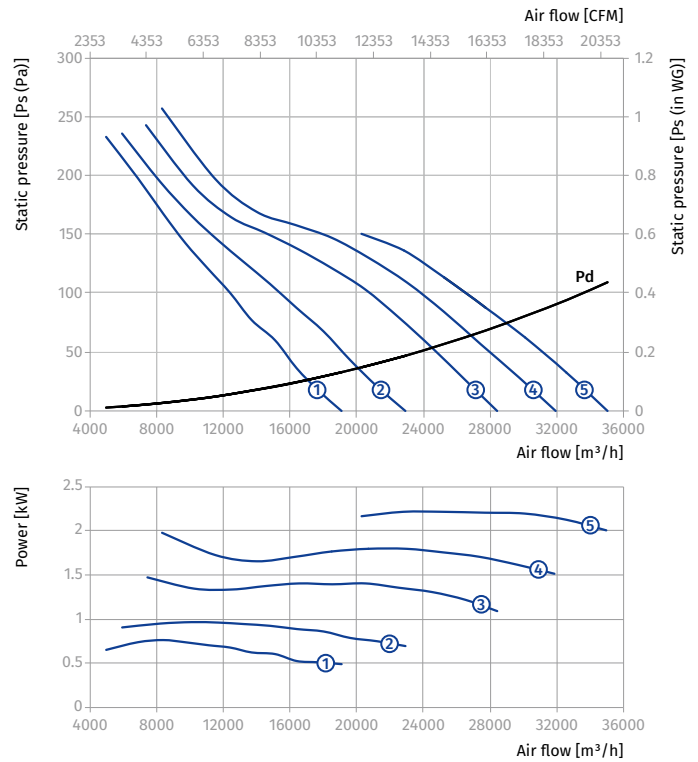

AXIAL SMOKE EXTRACTION FANS

AXIS-FP 1120...400/2

Size	Number of poles	Voltage [V/60 Hz]	Fan model	Installed motor power Ny [kW]	RPM [min ⁻¹]	Number of blades	Blade setting angle [°]	Weight [kg]	Length L [mm]	Curve number on graph
Axis-FP 1120-4D...400/2										
1120	4	3~400	Axis-FP 1120-4D/7.5-5/20/AL	7.5	1728	5	20	187	600	①
			Axis-FP 1120-4D/9.2-5/23/AL	9.2	1728	5	23	189	600	②
			Axis-FP 1120-4D/11-5/26/AL	11	1728	5	26	192	600	③
			Axis-FP 1120-4D/15-5/30/AL	15	1728	5	30	282	750	④
			Axis-FP 1120-4D/18.5-5/33/AL	18.5	1728	5	33	299	750	⑤
			Axis-FP 1120-4D/22-5/36/AL	22	1728	5	36	339	800	⑥
Axis-FP 1120-6D...400/2										
1120	6	3~400	Axis-FP 1120-6D/2.2-5/20/AL	2.2	1152	5	20	136	550	①
			Axis-FP 1120-6D/3-5/25/AL	3	1152	5	25	149	550	②
			Axis-FP 1120-6D/4.5-5/29/AL	4.5	1152	5	29	178	600	③
			Axis-FP 1120-6D/5.5-5/33/AL	5.5	1152	5	33	183	600	④
			Axis-FP 1120-6D/7.5-5/38/AL	7.5	1152	5	38	194	600	⑤
			Axis-FP 1120-6D/9.2-5/43/AL	9.2	1152	5	43	286	750	⑥

Standard size: 1120
Number of poles: 4
Fire resistance rating: 400/2

Standard size: 1120
Number of poles: 6
Fire resistance rating: 400/2

AXIAL SMOKE EXTRACTION FANS

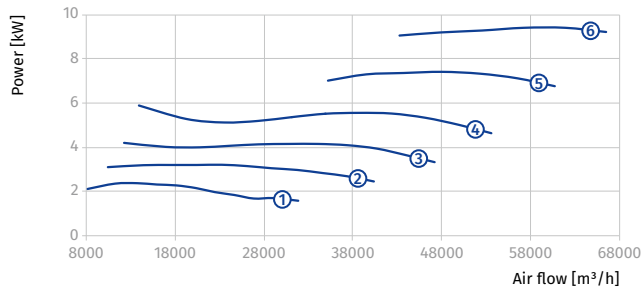
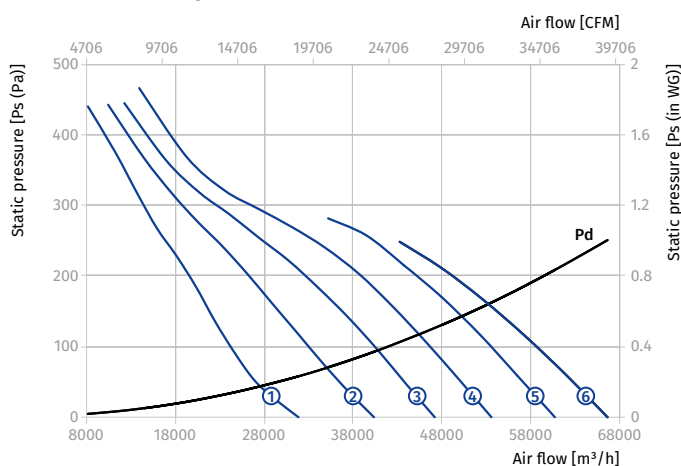
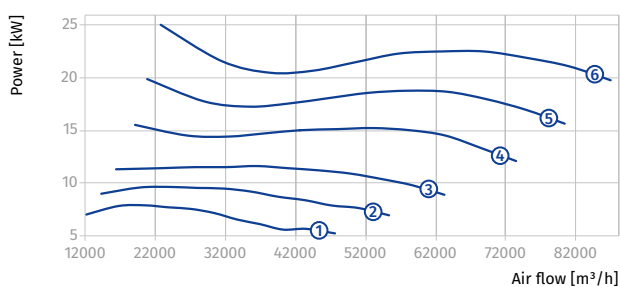
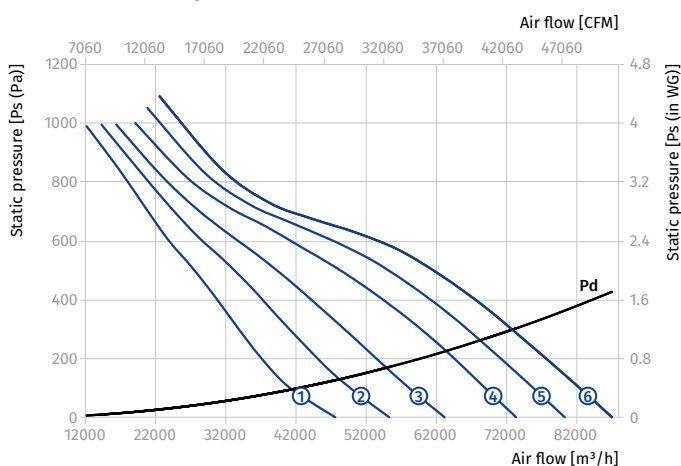

AXIS-FP 1120...400/2

Size	Number of poles	Voltage [V/60 Hz]	Fan model	Installed motor power N_y [kW]	RPM [min^{-1}]	Number of blades	Blade setting angle [°]	Weight [kg]	Length L [mm]	Curve number on graph
Axis-FP 1120-4/8D...400/2										
1120	4/6	3~400	Axis-FP 1120-4/6D/10/3.3-5/25/AL	10/3.3	1728/1152	5	25	297	750	①
			Axis-FP 1120-4/6D/14/4.5-5/29/AL	14/4.5	1728/1152	5	29	312	750	②
			Axis-FP 1120-4/6D/16/6.5-5/31/AL	16/6.5	1728/1152	5	31	384	800	③
			Axis-FP 1120-4/6D/20/8.5-5/34/AL	20/8.5	1728/1152	5	34	387	800	④

Standard size: 1120
 Number of poles: 4
 Fire resistance rating: 400/2

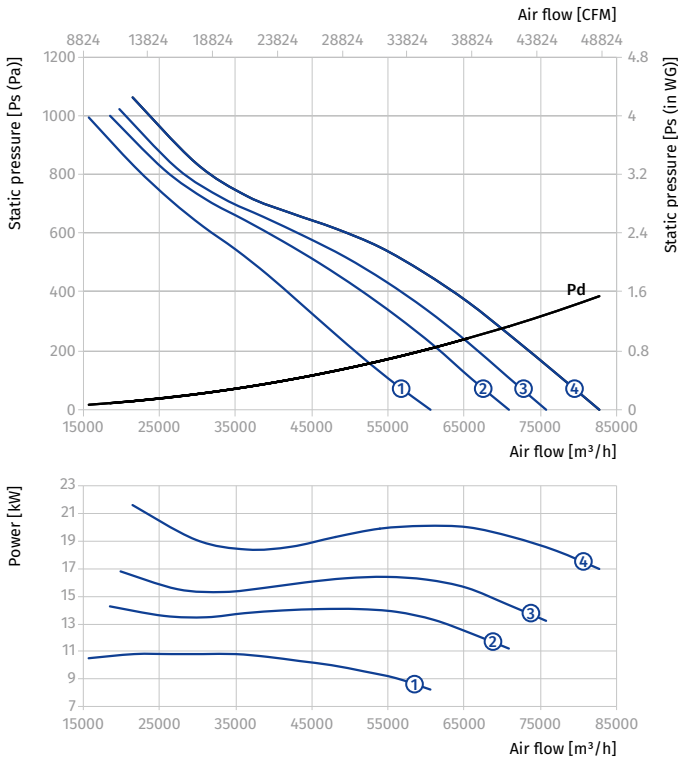

Standard size: 1120
 Number of poles: 6
 Fire resistance rating: 400/2

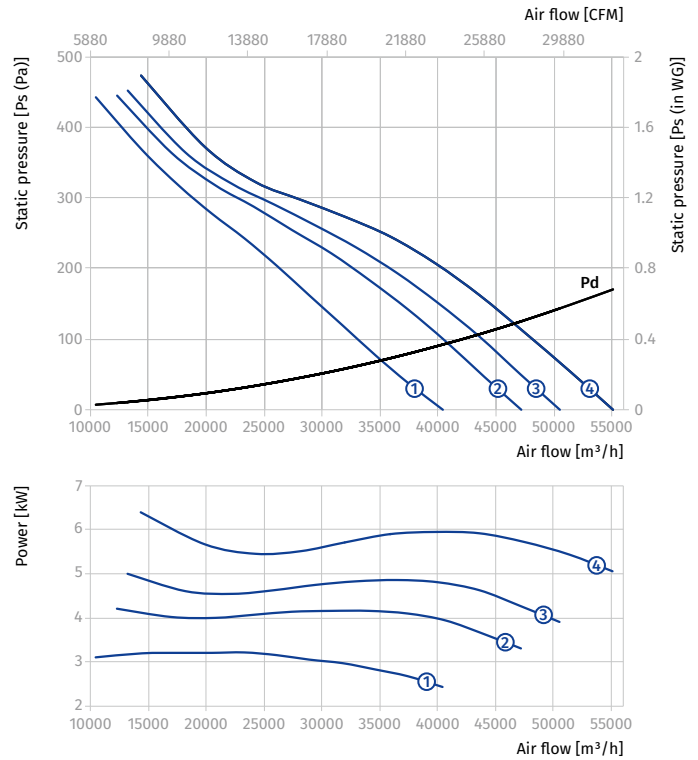

AXIAL SMOKE EXTRACTION FANS

AXIS-FP 1120...400/2

Size	Number of poles	Voltage [V/60 Hz]	Fan model	Installed motor power Ny [kW]	RPM [min ⁻¹]	Number of blades	Blade setting angle [°]	Weight [kg]	Length L [mm]	Curve number on graph
Axis-FP 1120-4/6D...400/2										
1120	4/8	3~400	Axis-FP 1120-4/8D/7.2/1.8-5/20/AL	7.2/1.8	1728/864	5	20	199	600	①
			Axis-FP 1120-4/8D/11/3-5/26/AL	11/3	1728/864	5	26	296	750	②
			Axis-FP 1120-4/8D/14/3.5-5/29/AL	14/3.5	1728/864	5	29	312	750	③
			Axis-FP 1120-4/8D/17/4.3-5/32/AL	17/4.3	1728/864	5	32	351	800	④
			Axis-FP 1120-4/8D/20/5-5/34/AL	20/5	1728/864	5	34	379	800	⑤

Standard size: 1120
Number of poles: 4
Fire resistance rating: 400/2

Standard size: 1120
Number of poles: 8
Fire resistance rating: 400/2

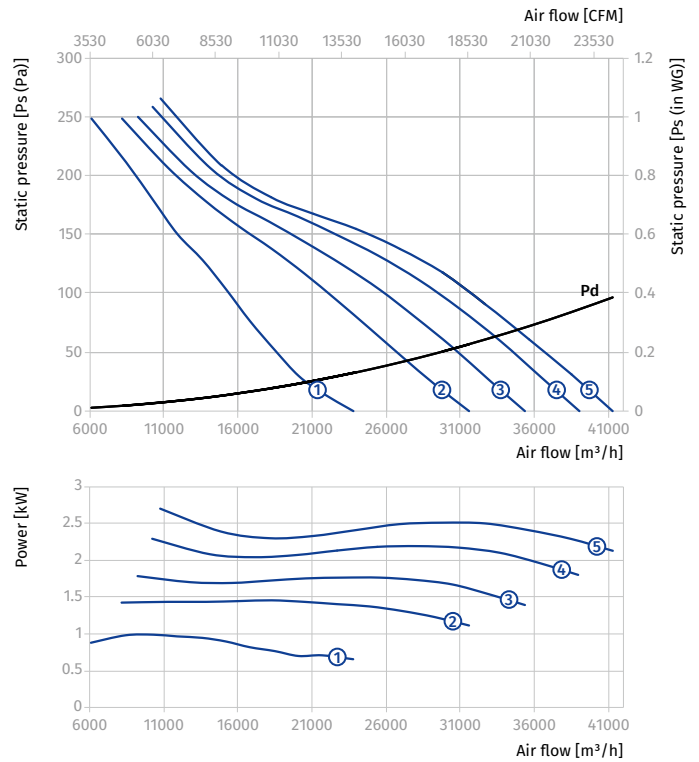
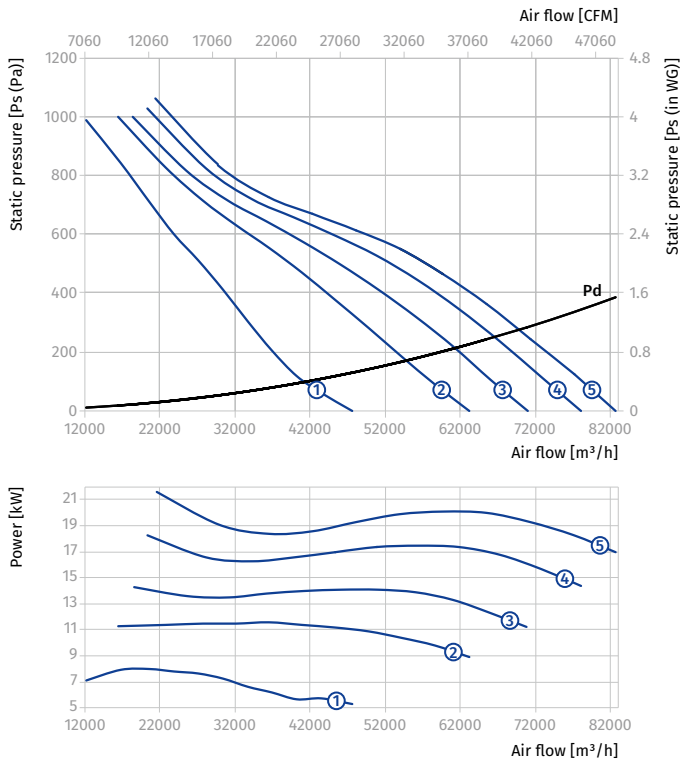

AXIAL SMOKE EXTRACTION FANS

AXIS-FP 1250...400/2

Size	Number of poles	Voltage [V/60 Hz]	Fan model	Installed motor power Ny [kW]	RPM [min ⁻¹]	Number of blades	Blade setting angle [°]	Weight [kg]	Length L [mm]	Curve number on graph
Axis-FP 1250-4D...400/2										
1250	4	3~400	Axis-FP 1250-4D/18.5-4/23/AL	18.5	1728	4	23	320.5	750	①
			Axis-FP 1250-4D/22-4/28/AL	22	1728	4	28	361.5	800	②
			Axis-FP 1250-4D/30-4/34/AL	30	1728	4	34	423	850	③
Axis-FP 1250-6D...400/2										
1250	6	3~400	Axis-FP 1250-6D/4.5-4/22/AL	4.5	1152	4	22	216.5	600	①
			Axis-FP 1250-6D/5.5-4/25/AL	5.5	1152	4	25	221.5	600	②
			Axis-FP 1250-6D/7.5-4/30/AL	7.5	1152	4	30	232.5	600	③
			Axis-FP 1250-6D/9.2-4/34/AL	9.2	1152	4	34	307.5	750	④
			Axis-FP 1250-6D/11-4/38/AL	11	1152	4	38	320.5	750	⑤

Standard size: 1250
 Number of poles: 4
 Fire resistance rating: 400/2

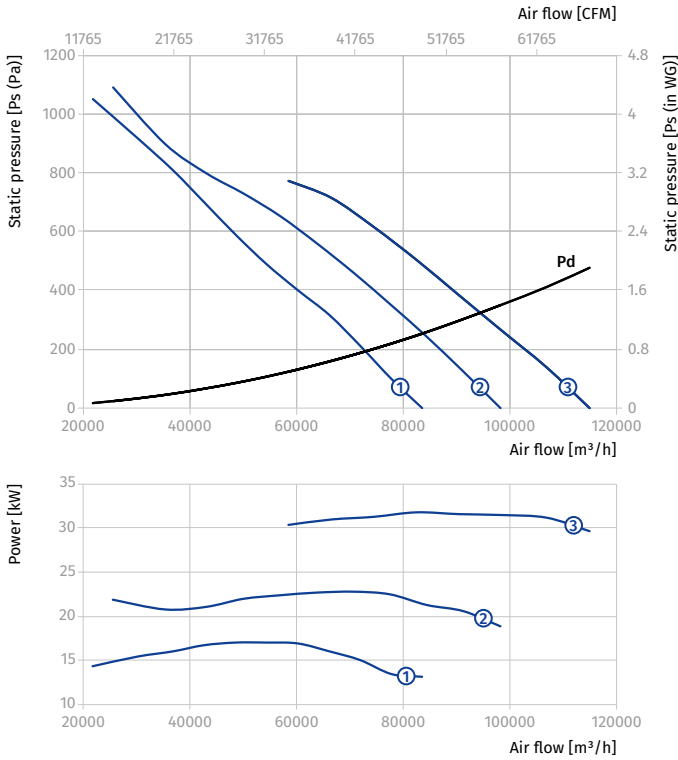

Standard size: 1250
 Number of poles: 6
 Fire resistance rating: 400/2

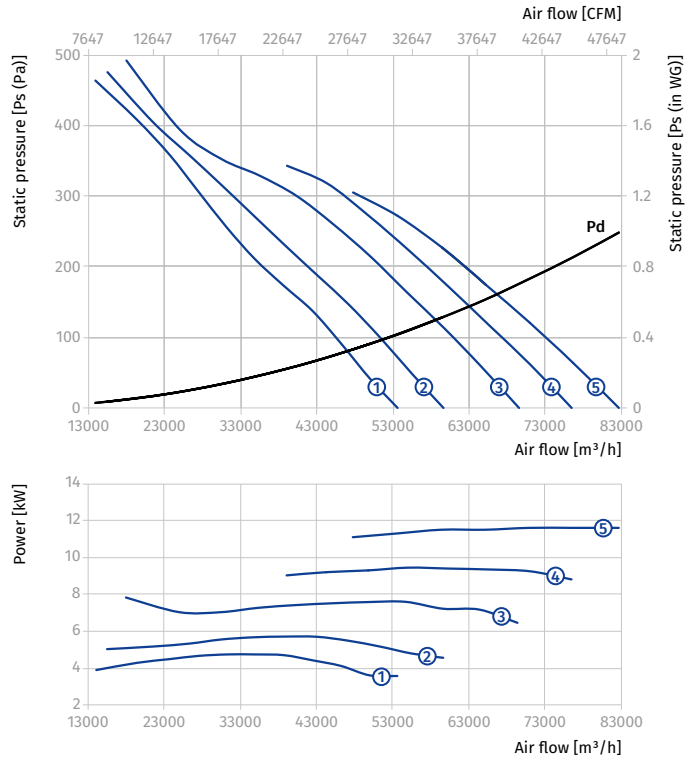

AXIAL SMOKE EXTRACTION FANS

AXIS-FP 1250...400/2

Size	Number of poles	Voltage [V/60 Hz]	Fan model	Installed motor power Ny [kW]	RPM [min ⁻¹]	Number of blades	Blade setting angle [°]	Weight [kg]	Length L [mm]	Curve number on graph
Axis-FP 1250-4/6D...400/2										
1250	4/6	3~400	Axis-FP 1250-4/6D/16/6.5-4/22/AL	16/6.5	1728/1152	4	22	406.5	800	①
			Axis-FP 1250-4/6D/20/8.5-4/26/AL	20/8.5	1728/1152	4	26	409.5	800	②
			Axis-FP 1250-4/6D/26/9-4/30/AL	26/9	1728/1152	4	30	508	850	③

Standard size: 1250
Number of poles: 4
Fire resistance rating: 400/2

Standard size: 1250
Number of poles: 6
Fire resistance rating: 400/2

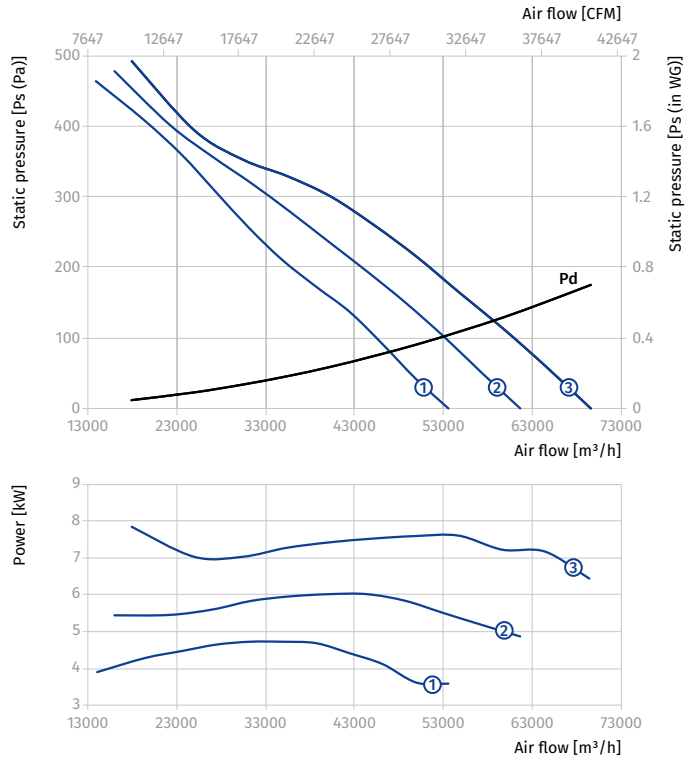
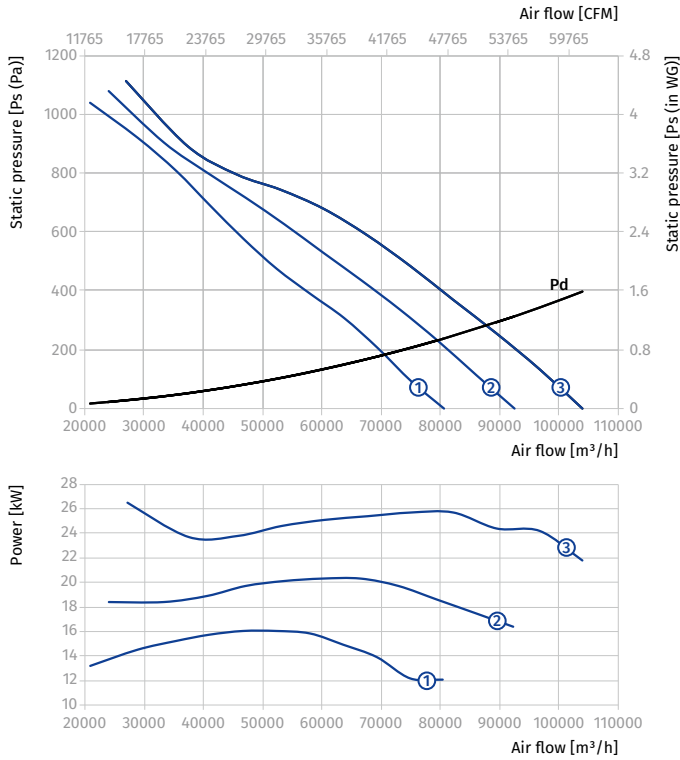

AXIAL SMOKE EXTRACTION FANS

AXIS-FP 1250...400/2

Size	Number of poles	Voltage [V/60 Hz]	Fan model	Installed motor power N_y [kW]	RPM [min^{-1}]	Number of blades	Blade setting angle [°]	Weight [kg]	Length L [mm]	Curve number on graph
Axis-FP 1250-4/8D...400/2										
1250	4/8	3~400	Axis-FP 1250-4/8D/17/4.3-4/23/AL	17/4.3	1728/864	4	23	373.5	800	①
			Axis-FP 1250-4/8D/20/5-4/26/AL	20/5	1728/864	4	26	401.5	800	②
			Axis-FP 1250-4/8D/28/6.5-4/32/AL	28/6.5	1728/864	4	32	463	850	③

Standard size: 1250
 Number of poles: 4
 Fire resistance rating: 400/2

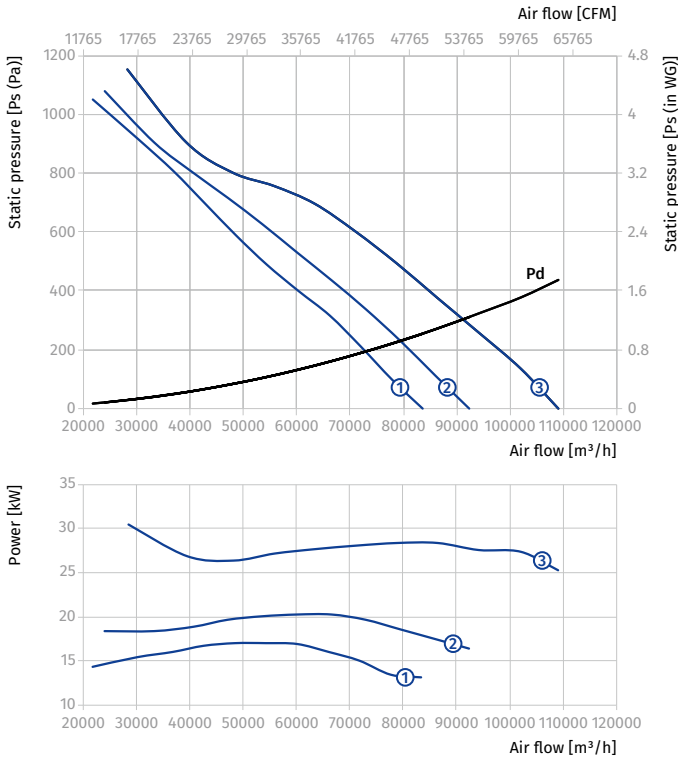

Standard size: 1250
 Number of poles: 8
 Fire resistance rating: 400/2

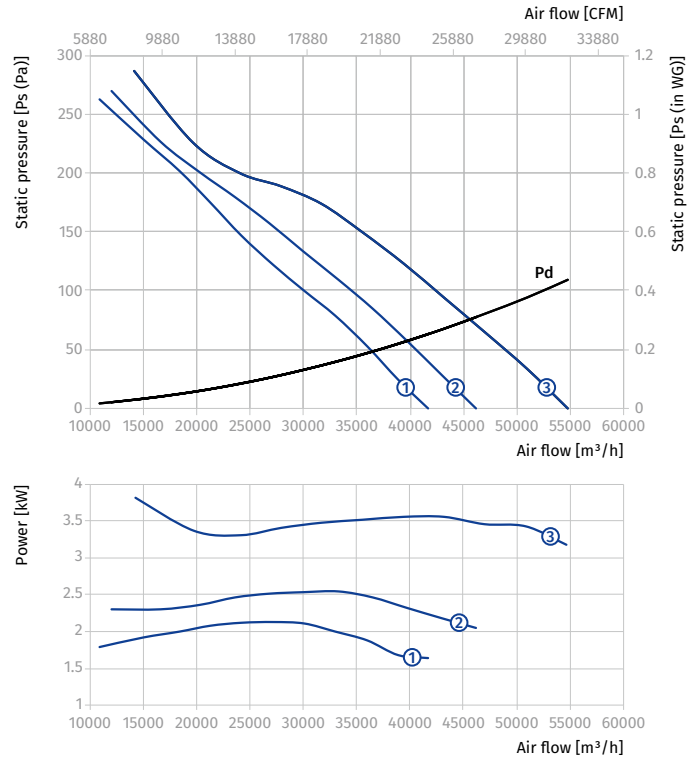

AXIAL SMOKE EXTRACTION FANS