



HEAT RECOVERY AIR HANDLING UNIT EQUIPPED WITH A HEAT PUMP



KOMFORT Roto EC LHP400 S17
KOMFORT Roto EC LHP700 S17
KOMFORT Roto EC LHP900 S17
KOMFORT Roto EC LEHP400 S17
KOMFORT Roto EC LEHP700 S17
KOMFORT Roto EC LEHP900 S17

KOMFORT Roto EC LHP400 S18
KOMFORT Roto EC LHP700 S18
KOMFORT Roto EC LHP900 S18
KOMFORT Roto EC LEHP400 S18
KOMFORT Roto EC LEHP700 S18
KOMFORT Roto EC LEHP900 S18

EN

USER'S MANUAL



BLAUBERG
Ventilatoren



CONTENTS

Safety requirements 3
Introduction 5
Purpose 5
Delivery set 5
Designation key 5
Technical data 6
Unit design and operating logic 8
Mounting and set-up 10
Connection to power mains 14
Unit control 15
Technical maintenance 26
Troubleshooting 27
Storage and transportation regulations 27
Manufacturer's warranty 28
Acceptance certificate 29
Seller information 29
Installation certificate 29
Warranty card 30



SAFETY REQUIREMENTS





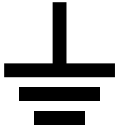

- Read the user's manual carefully prior to installing and operating the air handling unit (hereinafter referred to as «the unit»).
- Fulfil the user's manual requirements as well as the provisions of all the applicable local and national construction, electrical and technical norms and standards.
- The warnings contained in the user's manual must be considered most seriously since they contain vital personal safety information.
- Failure to follow the rules and safety precautions noted in this user's manual may result in an injury or unit damage.
- After a careful reading of the manual, keep it for the entire service life of the unit.
- While transferring the unit control the user's manual must be turned over to the receiving operator.

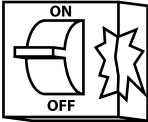
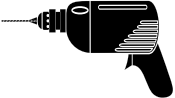
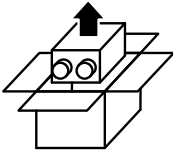
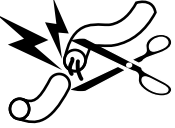
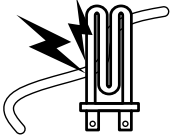
Symbol legend:

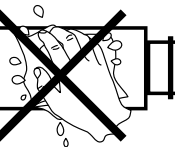
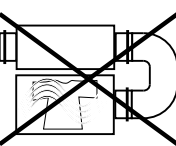
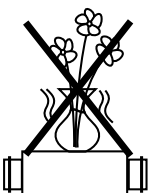
	WARNING!
	DO NOT!

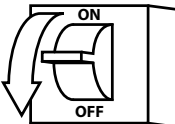
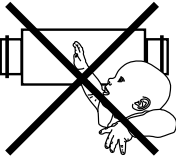
UNIT MOUNTING SAFETY PRECAUTIONS

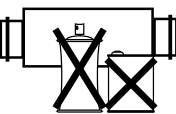
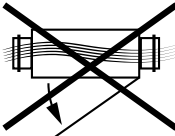
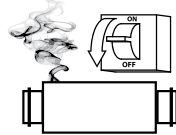
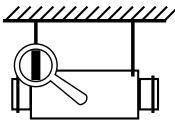
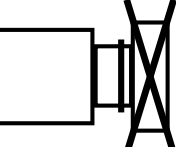
	Disconnect the unit from power mains prior to any installation or repair operations.		The unit must be grounded!
	Do not operate the unit outside the temperature range stated in the user's manual as well as in aggressive or explosive environments.		Do not use damaged equipment or cables when connecting the unit to power mains.
	While installing the unit follow the safety regulations specific to the use of electric tools.		Unpack the unit with care.
	"Do not change the power cable length at your own discretion. Do not bend the power cable. Avoid damaging of the power cable."		Do not position any heating devices or other equipment in close proximity to the unit power cable.

	<p>Do not touch the unit controls with wet hands. Do not carry out the maintenance operations with wet hands.</p>		<p>Do not wash the unit with water. Protect the electric parts of the unit against ingress of water.</p>
	<p>Use the unit only for its intended purpose. Do not connect a clothes dryer or other similar equipment to the unit or the ventilation system.</p>		<p>Do not put any water containers on the unit, i.e. flower vases etc.</p>
	<p>Do not sit on the unit and avoid placing foreign objects on it.</p>		<p>Disconnect the unit from power mains prior to any technical maintenance.</p>
	<p>Do not allow children to operate the unit.</p>		<p>Do not damage the power cable while operating the unit. Do not put any objects on the power cable.</p>
	<p>Do not store any explosive or highly flammable substances in close proximity to the unit.</p>		<p>Do not open the unit during operation.</p>
	<p>When the unit generates unusual sounds, odour or emits smoke disconnect it from power supply and contact the Seller.</p>		<p>In case of continuous operation of the unit periodically check the security of mounting.</p>
	<p>Do not block the air duct when the unit is switched on.</p>		<p>Do not let air flow from the unit be directed to the open flame devices or candles.</p>

INTRODUCTION

This user's manual includes technical description, operation, installation and mounting guidelines, technical data for the KOMFORT Roto EC L(E)HP heat recovery air handling unit, hereinafter referred to as «the unit».

PURPOSE

The unit is designed to ensure continuous mechanical air exchange in houses, offices, hotels, cafés, conference halls, and other utility and public spaces as well as to recover the heat energy contained in the air extracted from the premises to warm up the filtered stream of supply air.

The unit is not intended for organizing ventilation in swimming pools, saunas, greenhouses, summer gardens, and other spaces with high humidity.

Due to the ability to save heating energy by means of energy recovery, the unit is an important element of energy-efficient premises.

The unit is a component part and is not designed for stand-alone operation.

It is rated for continuous operation.

Transported air must not contain any flammable or explosive mixtures, evaporation of chemicals, sticky substances, fibrous materials, coarse dust, soot and oil particles or environments favourable for the formation of hazardous substances (toxic substances, dust, pathogenic germs).

Relative humidity of transported air must not exceed 80 % at an ambient temperature of +20 °C.



**THE UNIT MAY NOT BE OPERATED BY CHILDREN OR PERSONS WITH REDUCED PHYSICAL, MENTAL OR SENSORY CAPACITIES, OR LACKING THE APPROPRIATE TRAINING.
THE UNIT MUST BE INSTALLED AND CONNECTED ONLY BY PROPERLY QUALIFIED PERSONNEL AFTER THE APPROPRIATE BRIEFING.
THE CHOICE OF UNIT INSTALLATION LOCATION MUST PREVENT UNAUTHORIZED ACCESS BY UNATTENDED CHILDREN.**

DELIVERY SET

Name	Number
Unit	1 item
Control panel	1 item
User's manual	1 item
Packing box	1 item

TECHNICAL DATA

The unit is designed for indoor application with the ambient temperature ranging from +1 °C up to +40 °C and relative humidity up to 80 %. In order to prevent condensation on the internal walls of the units, it is necessary that the surface temperature of the casing is 2-3 °C higher than the dew point temperature of the transported air.

Hazardous parts access and water ingress protection rating:

- IP 44 for the unit motors;
- IP 22 for the assembled unit connected to the air ducts.

The unit design is constantly being improved, so some models can slightly differ from those ones described in this manual.

TECHNICAL DATA

Model	KOMFORT Roto EC LHP400	KOMFORT Roto EC LHP700	KOMFORT Roto EC LHP900	KOMFORT Roto EC LEHP400	KOMFORT Roto EC LEHP700	KOMFORT Roto EC LEHP900
Unit technical data						
Max. air capacity range [m ³ /h]	520	830	955	520	830	955
Transported air temperature [°C]	from -10 up to +40			from -25 up to +40		
Heat recovery efficiency of the rotary heat exchanger [%]	untill 85					
Sound pressure level at 3 m distance [dB(A)]	45	52	58	45	52	58
Casing material	High-strength galvanized steel					
Coating	Aluzinc					
Weight [kg]	150	160	165	150	160	165
Connected air duct diameter [mm]	Ø 160	Ø 250	Ø 250	Ø 160	Ø 250	Ø 250
Heat exchanger type	Rotary					
Heat exchanger material	Aluminium					
Filter:	Extract		G4			
	Intake		G4 (F7*)			
Unit electric parameters						
Unit voltage [V / 50 Hz]	1~230					
Maximum power in Heat Recovery mode [kW]	0,31	0,36	0,46	0,31	0,36	0,46
Maximum power in Heat Recovery + Heat Pump mode [kW]	0,75	0,94	1,20	0,75	0,94	1,20
Maximum power in Heat Recovery + Heat Pump + Preheating mode [kW]	-	-	-	2,15	3,74	4,0
Maximum unit current [A]	4,6	5,7	6,7	10,9	18,5	19,4
Air-handling unit energy efficiency	in Heating mode (COP)		6,0	6,5	6,5	6,0
	in Cooling mode (ERR)		4,0	4,15	4,25	4,0
Heat pump specifications						
Refrigerant type	R410A					
Refrigerant weigh [kg]	0,8	1,0	2,0	0,8	1,0	2,0
Thermal performance in the Heating mode [kW] at $t_o = +7\text{ °C}; t_k = +45\text{ °C}$	1,56	2,60	3,25	1,56	2,60	3,25
Refrigerating capacity in the Cooling mode [kW] at $t_o = +7\text{ °C}; t_k = +45\text{ °C}$	1,20	2,0	2,50	1,20	2,0	2,50
Compressor type	Sealed, rotary					
Setpoint temperature range in Cooling/Heating modes [°C]	+16 ... +30					

t_o — refrigerant boiling point.

t_k — dew-point temperature.

* — option.

**OVERALL DIMENSIONS OF THE UNIT, MM
KOMFORT ROTO EC L(E)HP 400**

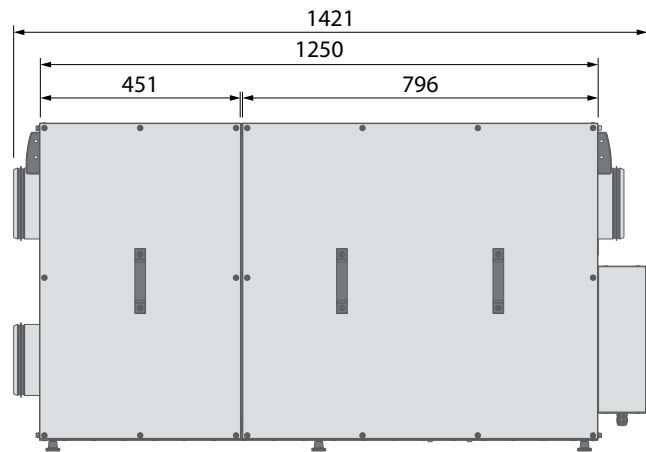
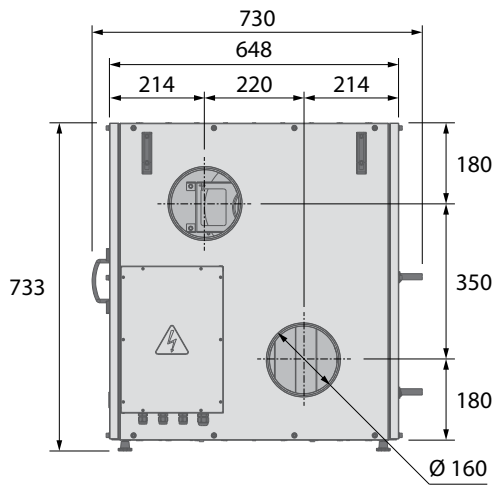

KOMFORT ROTO EC L(E)HP 700 AND KOMFORT ROTO EC L(E)HP 900

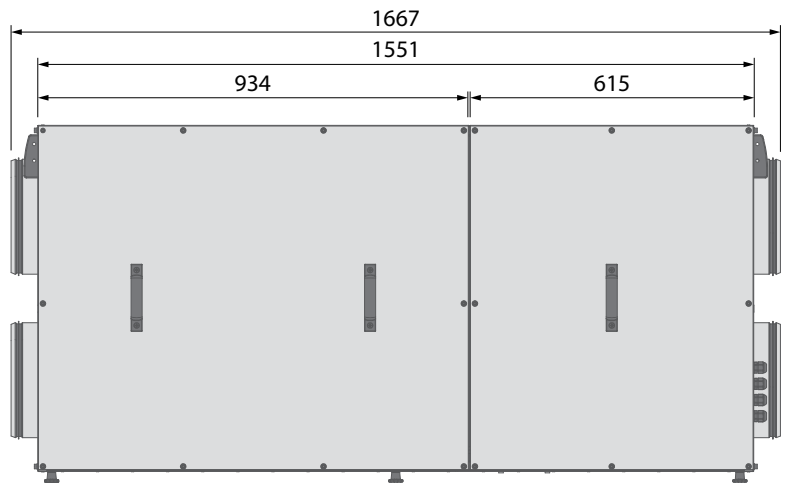
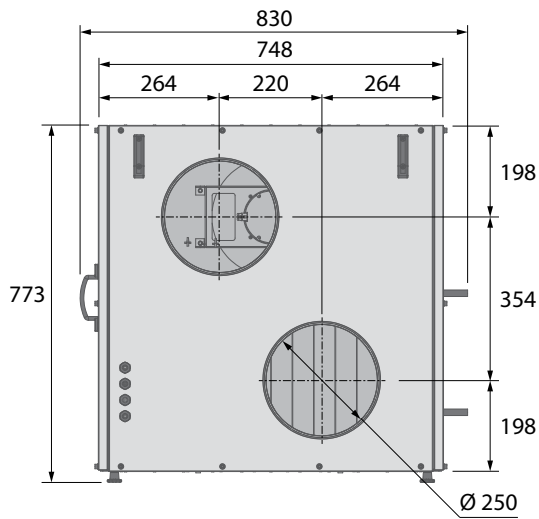

UNIT DESIGN AND OPERATING LOGIC

The unit has the following operating logic:

Warm stale extract air from the room flows to the unit, where it is filtered by the supply filter. Then the air is moved through the rotary heat exchanger, then through the condenser/evaporator of the heat pump and is exhausted outside with the exhaust fan. Fresh air from outside flows into the unit, where it is cleaned in the intake filter. Then the air flows through the electric heater, which is used for air preheat in the cold season. Then the air flows through the rotary heat exchanger to the condenser/evaporator of the heat pump and is moved to the room with the supply fan.

Heat energy of warm extract air is transferred to clean intake fresh air from outside and warms it up in the rotary heat exchanger. Heat recovery minimizes thermal energy losses and space heating expenses in cold seasons.

Energy produced by the heat pump intensifies the heat recovery effect. The fresh intake air is heated or cooled by the heat exchanger and then by the heat pump. When the heat pump and the rotary heat exchanger work simultaneously the energy released to the energy consumed ratio is 1:8, which means that each kilowatt of electricity generates up to 8 kW of heat output.

The energy is first recovered in the heat exchanger and then the fresh air supplied into the serviced space is additionally heated or cooled by the heat pump.

Heat pump operation in the Heating mode.

The heat pump operates according to the reverse Carnot cycle. Ensuring the transfer of heat from a low-grade source (exhaust stale air from the serviced spaces) to the high-grade one (hot supply air downstream of the heat exchanger supplied into the serviced spaces) the heat pump itself produces no thermal energy. In other words the stale air is removed by the extract fan from the spaces, passes through the filter and the heat exchanger and is then directed into the heat pump evaporator. While passing through the evaporator the indoor air releases a certain part of its thermal energy which is transferred by the heat pump to the condenser heat recovery unit built into the supply air section. Fresh air is delivered by the supply fan, passes the filter and the heat exchanger and is then directed into the heat pump condenser unit. While passing through the condenser the supply air stream is warmed up by the thermal energy accumulated in the heat pump evaporator.

Heat pump operation in the Cooling mode.

The switching between operation modes (heating/cooling) is ensured by the four-way valve which alters the refrigerant flow therefore changing the heat exchanger operation mode: the heat-recovery unit in the exhaust section assumes the condenser function whereas the one in the supply section handles the evaporation. The warm fresh air from outdoors is delivered by the supply fan, passes through the filter, loses some of its thermal energy in the rotary heat exchanger and then enters the heat pump evaporator where it is finally cooled to the pre-set temperature. The heat pump then transfers the thermal energy extracted from the supply air during the cooling process to the condenser unit. The thermal energy accumulated in the condenser is transferred to the environment by means of the exhaust fan air supply.

**KOMFORT ROTO EC L(E)HP 400 unit design and operating principle
(service side view)**

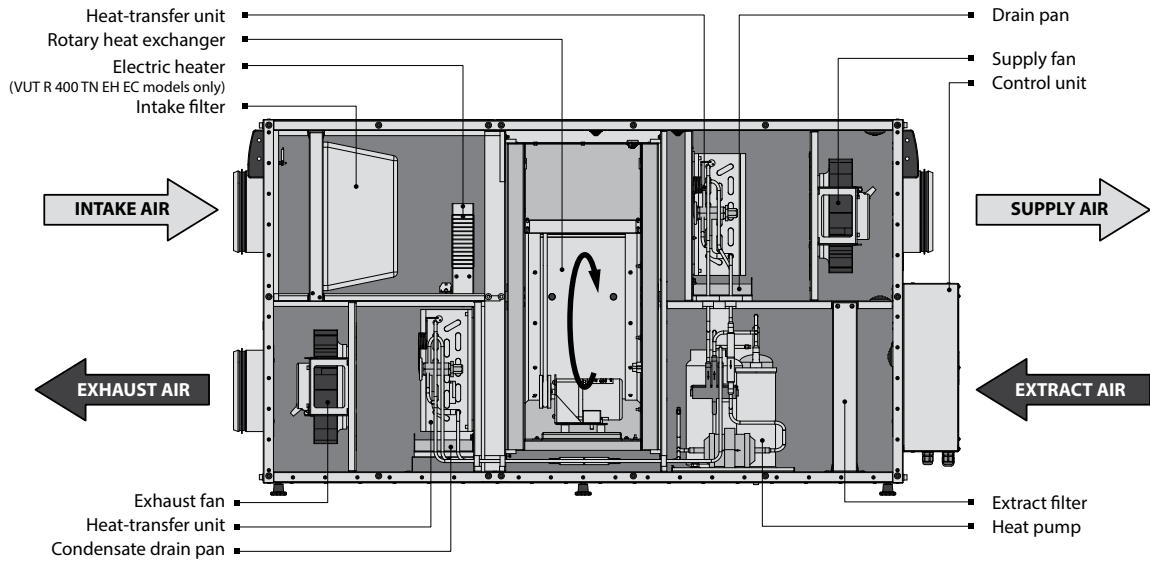

**KOMFORT ROTO EC L(E)HP 700/KOMFORT ROTO EC L(E)HP 900 design and operating principle
(service side view)**

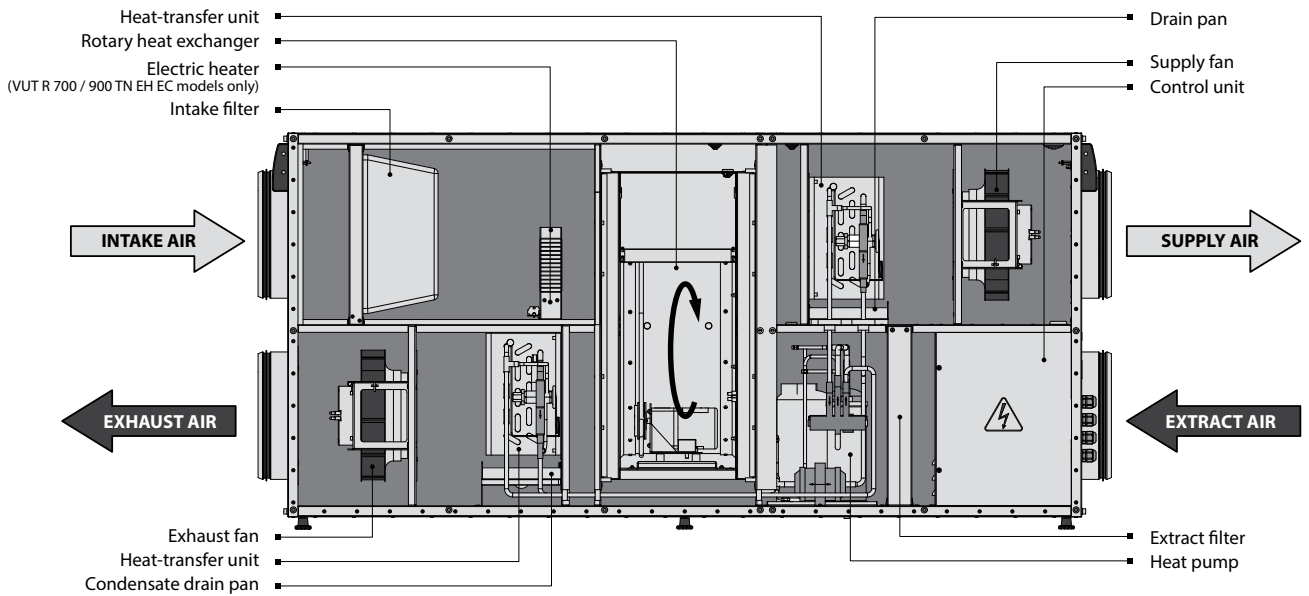

MOUNTING AND SET-UP



READ THE USER'S MANUAL PRIOR TO MOUNTING THE UNIT.

Ensure adequate access to the unit for maintenance and repair. The minimum required clearances between the unit and the adjoining walls are given in the figure below.

Minimum straight air duct length:

- equal to 1 air duct diameter on intake side
- equal to 3 air duct diameters on outlet side

If the air ducts are not connected or the connected air ducts are too short, protect the unit parts from ingress of foreign objects by covering the spigots with a protecting grille or other protecting device with mesh width not more than 12.5 mm to prevent uncontrollable access to the fans.

Before starting the unit make sure that the rotary heat exchanger cells are clean and free from damage. Also check the belt tension adjusted by means of the spring on the motor mount.

MINIMUM DISTANCES FOR ACCESSING THE UNIT

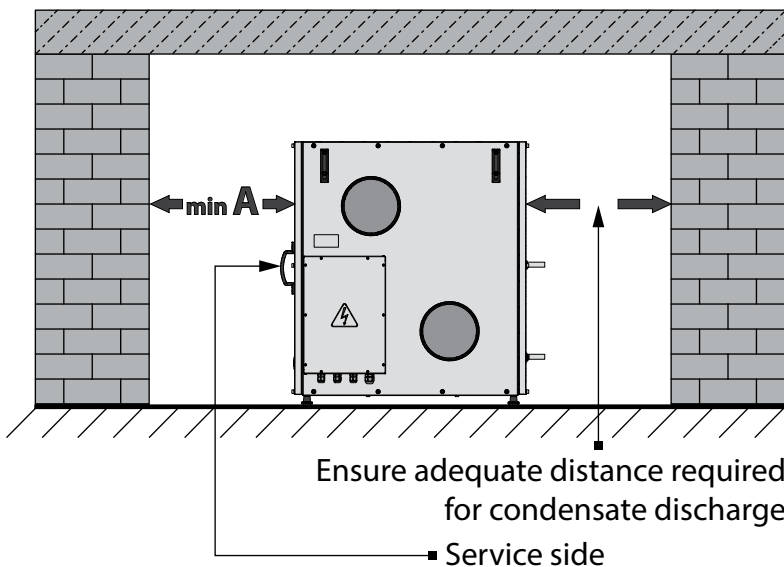

Model	A, mm
KOMFORT Roto EC LHP400	750
KOMFORT Roto EC LEHP400	
KOMFORT Roto EC LHP700	850
KOMFORT Roto EC LEHP700	
KOMFORT Roto EC LHP900	
KOMFORT Roto EC LEHP900	

* - the necessary distance is defined by the user while installing the unit based on the outside dimensions of the condensate drain pipe system.

The unit is suspended on threaded rods screwed into threaded anchors or other fasteners. The suitable fasteners are chosen by the installation contractor depending on the roofing system design and the unit weight. The unit is also suitable for installation on a flat horizontal surface on the plastic stubs provided.

SUSPENDED MOUNTING

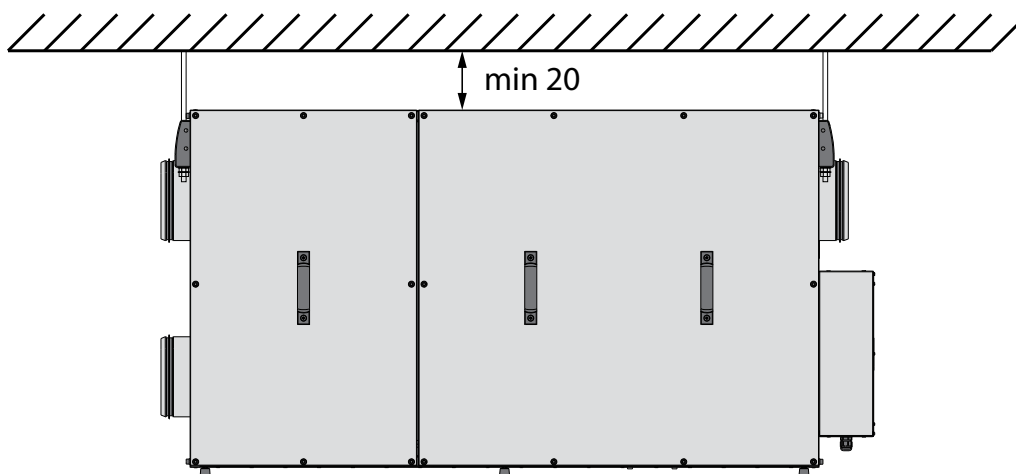

INSTALLATION ON HORIZONTAL SURFACE

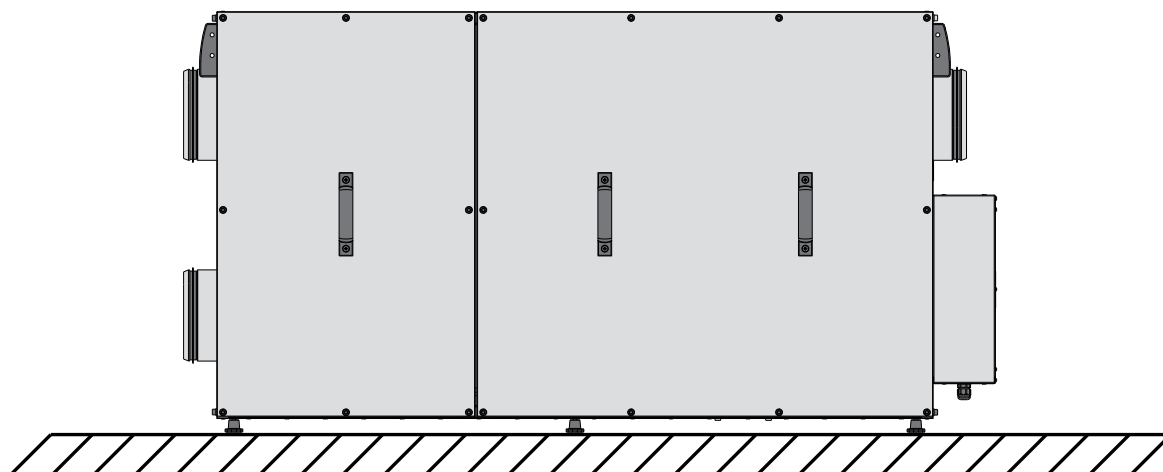

SAFETY PRECAUTIONS

The unit must be mounted to a rigid and stable structure.

The unit must be suspended using anchor bolts. Make sure that the base structure is capable of sustaining the unit weight. Otherwise reinforce the mounting location with beams or similar elements.

If the bolts used for the unit mounting are too short the unit can generate abnormal noise and resonate with the ceiling. Use bolts of sufficient length to prevent resonance.

If the abnormal noise is generated at the spiral air duct joint replace the spiral air duct with a flexible one to prevent resonance. Flexible anti-vibration connectors are another alternative for dealing with resonance.

CONDENSATE DRAINAGE

The unit is equipped with two pans for removal of the condensed water generated during the operation of the heat pump heat-transfer units.

To arrange a condensate drain connect the drain pipes and the U-traps to the sewage system using plastic or rubber pipes. The pipes must be installed at the minimum downward gradient of 3°.

Fill the U-trap with water before starting the unit. During the operation make sure to maintain the sufficient water level in the U-trap and enable unobstructed water flow from the unit into the sewage system. Failure to do so will result in accumulation of condensate during the heat pump operation which may cause unit failure and water ingress into the serviced spaces.

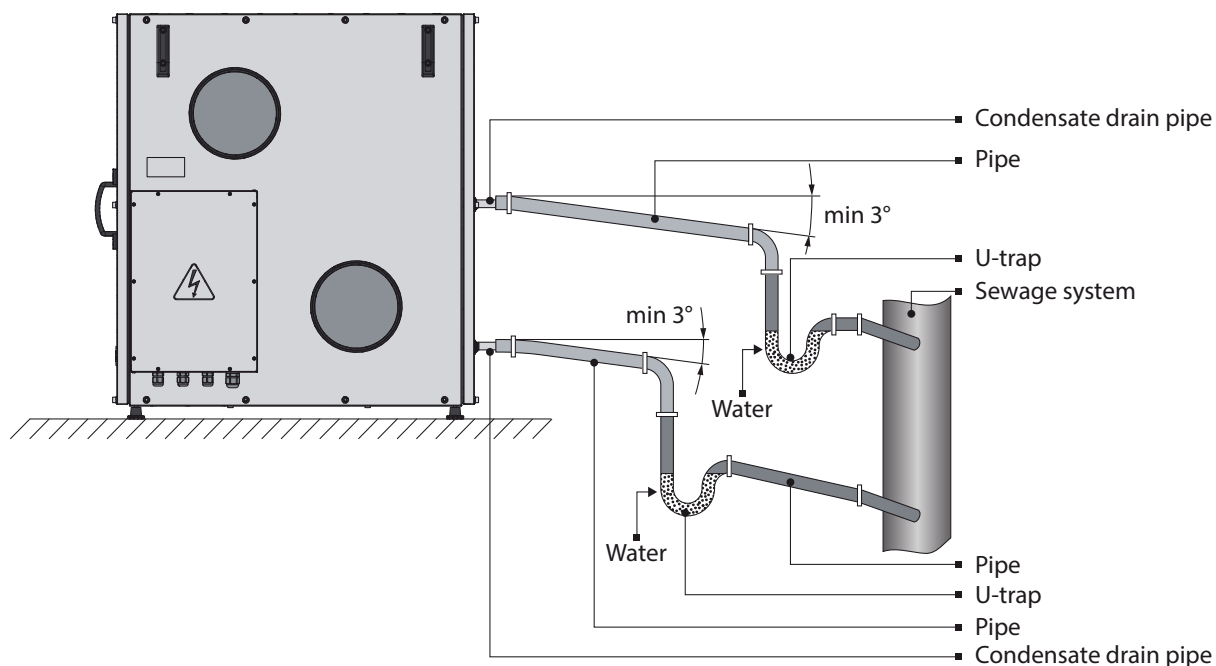

**ON COMPLETING THE UNIT INSTALLATION BALANCE THE AIR FLOW IN THE SUPPLY AND EXHAUST VENTILATION SYSTEM.
THE SUPPLY AIR FLOW MAY NOT EXCEED THE EXHAUST AIR FLOW BY MORE THAN 15 %.**

Th-Tune CONTROL PANEL INSTALLATION

To install the rear part of the control panel use a suitable mounting box (minimum diameter 65 mm and minimum depth 31 mm).

1. Use a screwdriver to pull the front and the rear sides of the control panel apart.

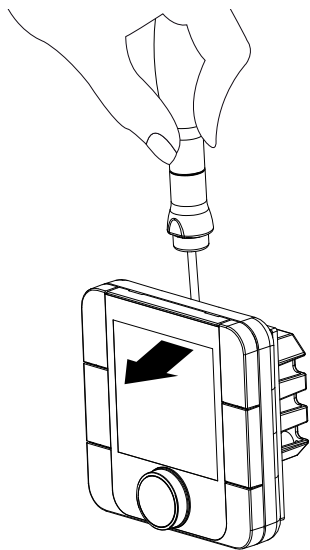

2. Disconnect the 4-pin socket from the front part of the control panel.

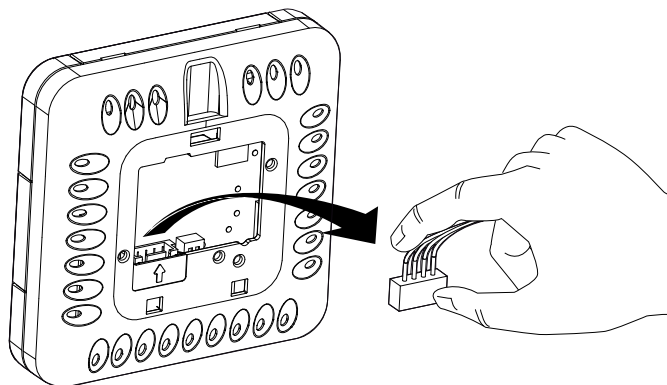

3. Complete the electrical connections according to the external connection diagram (Page. 14).

4. Secure the rear part of the control panel in the mounting box using the screws supplied.

5. Reattach the 4-pin connector.

6. Reassemble the control panel starting from bottom up and make sure that none of the internal wires prevent closing with a click.

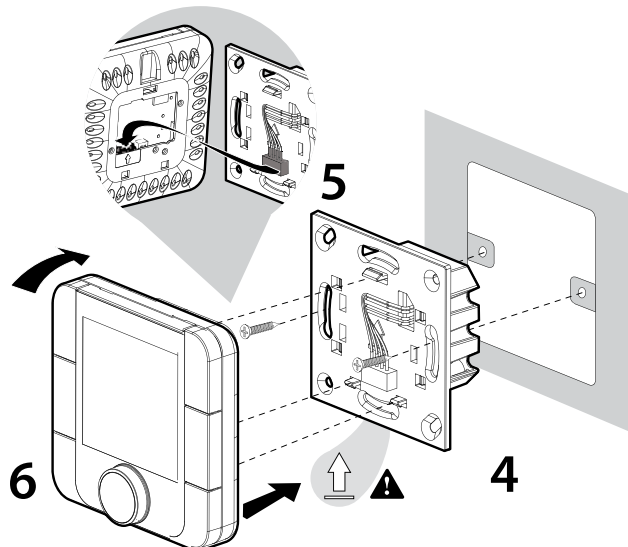
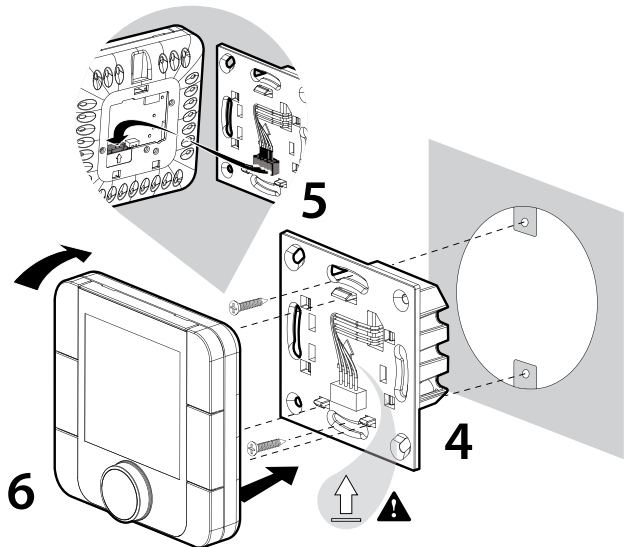

Overall dimensions of the control panel rear part, mm

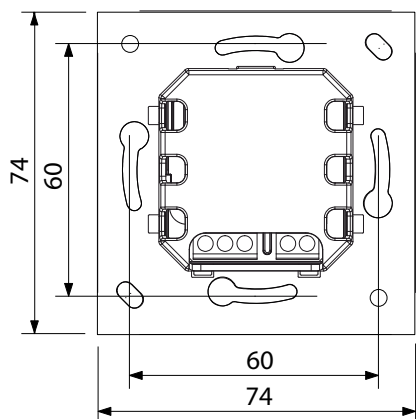

The outline drawing of the control panel rear part is on the left.

pGD1 CONTROL PANEL INSTALLATION

Connect the pGD1 control panel to the controller connector (see the figure on page 15) using the 6P6C (PLUG-6P6C-P-C2) phone plug. The maximum length of the phone cable is 50 m.

To mount the control panel on a wall route the phone cable to the selected location.

1. Secure the rear part of the casing in the standard box by means of the round-head screws supplied.

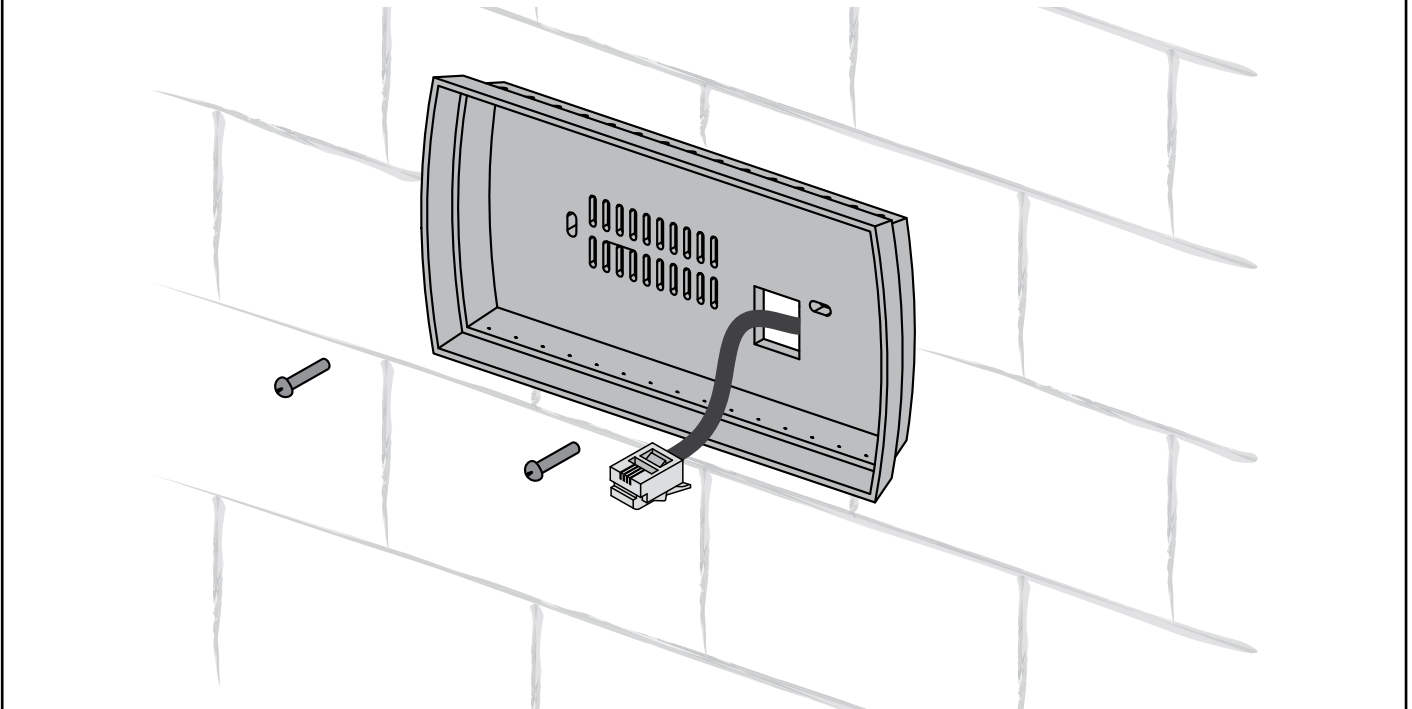

2. Connect the phone cable to the front part of the control panel. Install the front part of the control panel into the box by fastening it to the rear part of the casing with countersunk screws supplied as shown in the figure below and then install the front bezel by pushing it until it clicks in position.

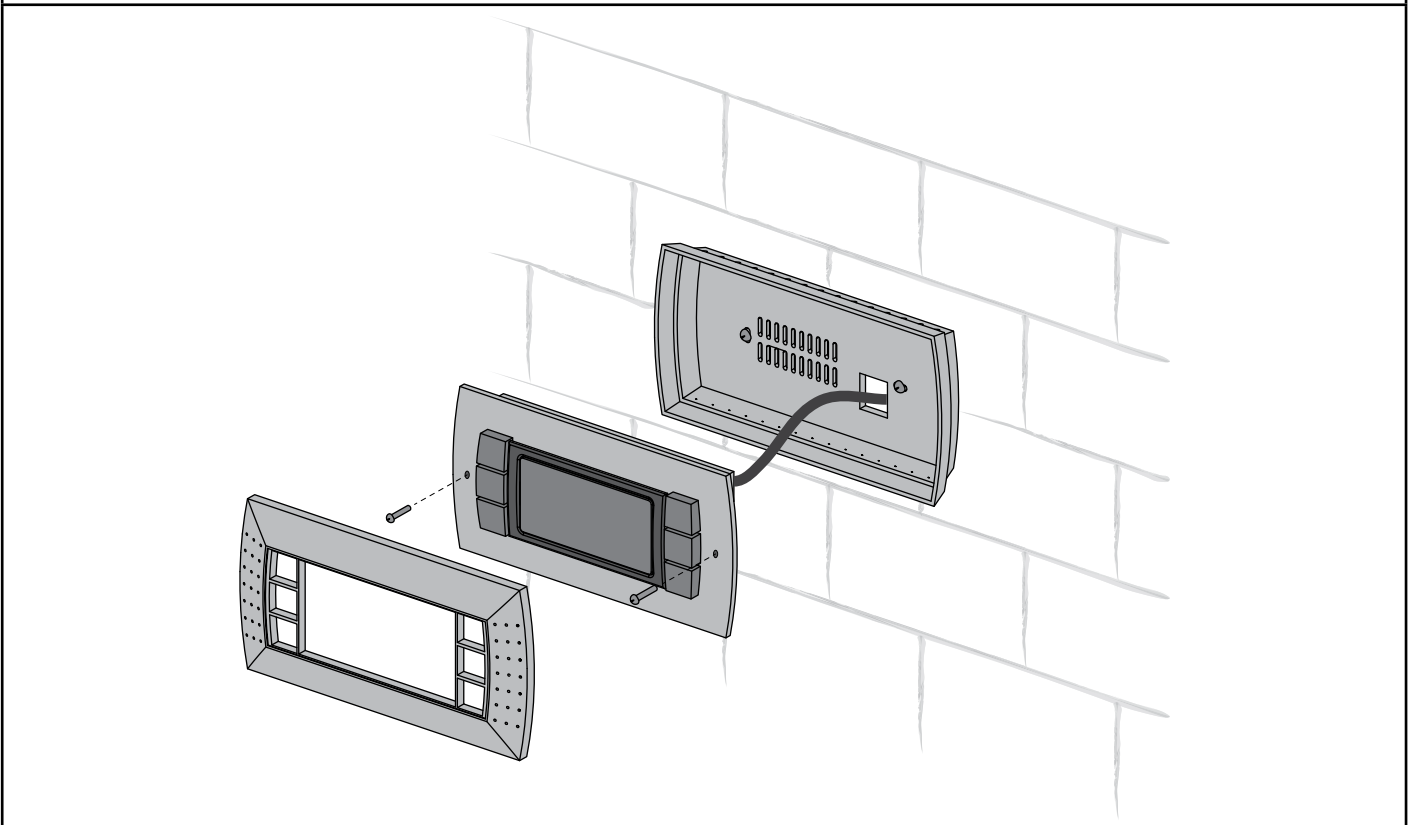

CONNECTION TO POWER MAINS



DISCONNECT THE UNIT FROM POWER MAINS PRIOR TO ANY OPERATIONS. CONNECTION OF THE UNIT TO POWER MAINS IS ALLOWED BY A QUALIFIED ELECTRICIAN WITH A WORK PERMIT FOR THE ELECTRIC UNITS UP TO 1000 V AFTER CAREFUL READING OF THE PRESENT USER'S MANUAL. THE RATED ELECTRICAL PARAMETERS OF THE UNIT ARE GIVEN ON THE MANUFACTURER'S LABEL. ANY TAMPERING WITH THE INTERNAL CONNECTIONS IS PROHIBITED AND WILL VOID THE WARRANTY.

The unit is designed for 230 V / 50 Hz single-phase alternating current mains. The cable is not included in the delivery set. Use insulated cables with the minimum cross-section of 2.5 mm² (up to 50 m long) and 4 mm² (up to 100 m long).

The cable cross-section is given for reference only. The actual conductor cross-section selection must be based on its type, the maximum permissible heating, insulation, length and installation method.

The unit is connected to power mains via an automatic circuit breaker with a magnetic trip built into the stationary wiring. The trip current of the automatic circuit breaker must correspond to the current consumption (see the «Technical data» table on page 6).

Use copper cables only.

All the control and power supply cables must be connected in accordance with the terminal markings while observing proper polarity.

**EXTERNAL CONNECTIONS DIAGRAM
KOMFORT ROTO EC L(E)HP A17 UNITS**

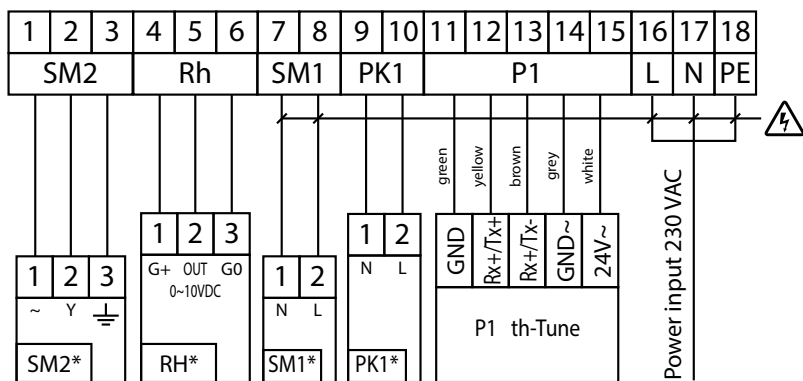

— ELECTRIC SHOCK HAZARD!

EXTERNAL HEATER WIRING DIAGRAM

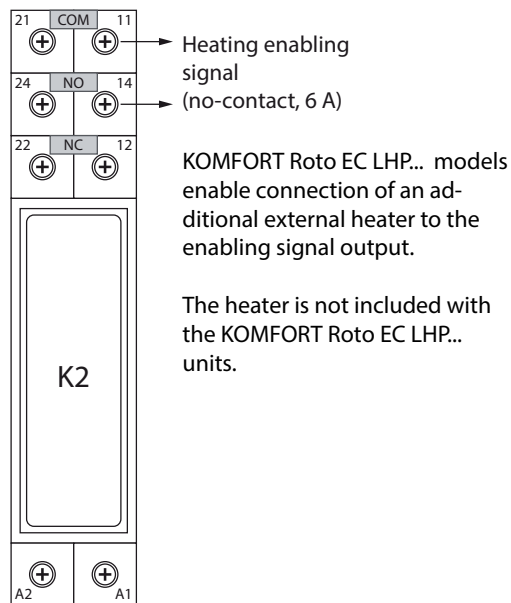

Designation	Name	Type	Wire
SM1*	Supply and/or exhaust damper electric actuator	LM 230A Belimo	2 x 0,75 mm ²
SM2*	Heat recovery damper electric actuator	CM24-SR Belimo	3 x 0,5 mm ²
RH1*	Humidity or CO2 sensor with 0-10 V output	-----	3 x 0,25 mm ²
PK1*	Contact from fire alarm panel	NC	2 x 0,5 mm ²
P1	Control panel	th-Tune (Carel)	5x0.25 mm ²

- 1. * — the appliances are not supplied with the unit, are available on the separate order.
- 2. — maximum connecting cable length is 20 m.
- 3. — the maximum length of the R1-terminated cable is selected according to the table below.

MAXIMUM CABLE LENGTH FROM CONTROLLER TO CONTROL PANEL

Cable type	Distance to power source
6P6C phone cable	up to 50 m
AWG24 shielded cable	up to 200 m

Contact the manufacturer if a longer cable is required.

UNIT CONTROL

The unit is equipped with a built-in automatic control system and a control panel.

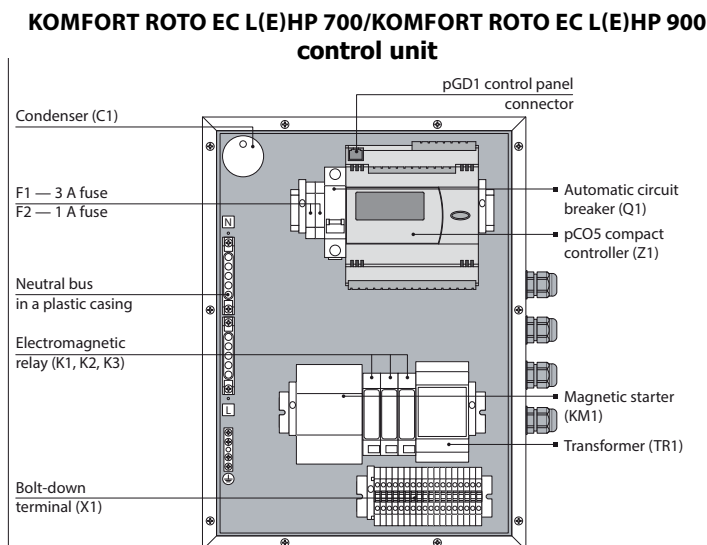
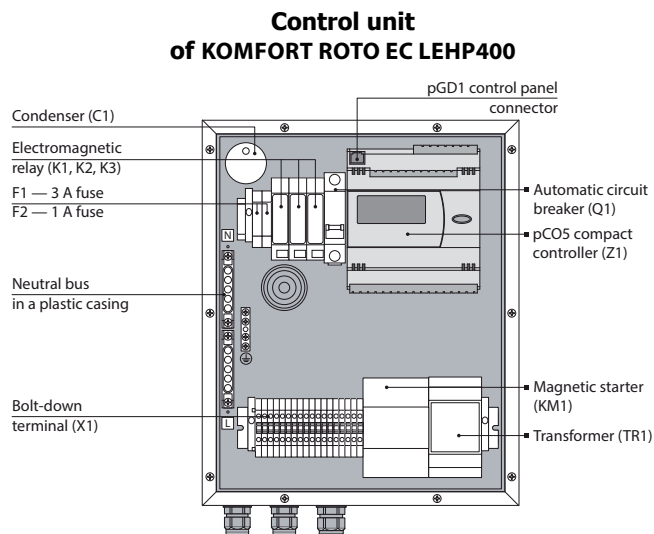

The automatic control system has the following functions:

1. Switching the unit on/off.
2. Unit operation mode selection: Automatic mode, Cooling mode, Heating mode, Ventilation mode (with pGD1 panel only).
3. Maintaining a pre-set room temperature by activating/deactivating the rotary heat exchanger and the heat pump. The automatic control system also controls the 4-way valve while heating or cooling the supply air and the air pre-heater unit operation by means of posistor heaters which engage on a section-by-section basis. The first section is engaged when the outdoor air temperature drops below -8°C whereas the second pre-heating section is engaged when the outdoor temperature drops below -16°C .
The posistor heater is absent on the VUT R...TN H EC units. If this unit modification is to be used in cold climatic conditions an in-line heater should be built into the supply duct. The unit has a no-contact for heater control.
4. Maintaining air humidity below a pre-set level.
5. Maintaining the CO_2 content in the air below a pre-set level. The CO_2 sensor is connected to the terminals replacing the humidity sensor. The CO_2 sensor must be rated 24 VAC and produce a 0-10 VDC measured voltage output signal.
6. Condenser defrosting control in the Heating mode.
7. Automatic reduction of the supply and exhaust ventilation flow rate to obtain the user-defined heating temperature.
8. Blocking cold air supply into the serviced spaces in the Auto or Heating mode by warming up the evaporator.
9. Heat pump protection against excessive pressure by means of air flow bursts.
10. Supply and exhaust fan operation control.
11. Filter contamination control (by the number of operating hours).
12. Unit operation according to a pre-programmed schedule.
13. Heat pump protection against abnormally high or low pressure in the freon line.
14. Control of the electric actuators operating the external air dampers (supply and/or exhaust) and the recirculation actuator.
15. System shutdown on command from the fire alarm board.

AUTOMATIC CONTROL SYSTEM DESIGN AND OPERATION

The automatic control system comprises a Carel controller (PCO5 kompakt), an outdoor air temperature sensor, the sensor for the air temperature downstream of the heat exchanger, a supply air temperature sensor, a sensor for the air temperature in the exhaust duct, an indoor air temperature sensor, a sensor for the temperature at the heat-transfer units, a high pressure sensor, a low pressure sensor, a compressor starter, circuit breakers, a magnetic starter, a supply transformer and an automatic compressor shutdown switch. The unit is controlled via th-Tune or PGD1 remote control panel.

The automatic control system enables safe automatic operation of the unit in the Auto, Cooling, Heating or Ventilation mode. In the Auto mode the unit maintains the indoor temperature at the pre-set level by automatically switching the 4-way valve to the heating or cooling mode, by enabling the heat exchanger and the compressor and by sending heating activation signals. While in the Heating and Cooling modes the automatic control system ensures the operation of the unit actuators in the required mode (heating or cooling only) and controls their performance. While in the Ventilation mode the unit adjusts the supply and exhaust fan speed, but does not control the air temperature. The Ventilation mode is appropriate for energy saving and ventilation if the difference between the outdoor and indoor temperatures is insignificant.

The supply and exhaust fan speed is set for each speed stage as a percentage from the maximum rotation speed.

The temperature is set up by changing the «Setpoint» parameter value.

The fans can be operated according to a daily schedule (up to 6 time ranges).

While in the Heating mode when the heat pump is on the unit periodically enters a defrosting cycle. The Defrosting mode is enabled when the condenser temperature falls below the value set via the controller menu (defrosting setpoint) at the frequency determined by setting the «Defrosting duration» parameter.

The Automatic Speed Drop mode can be enabled when the air temperature is low. In this mode the fan speed is adjusted according to the supply air temperature. The speed is reduced at temperature dropping and is restored to the initial setting provided a sufficient temperature reserve.

The «Auto» speed becomes available upon entering the Humidity Sensor Feedback mode enabling the unit to increase the air exchange rate automatically at an increase of the relative humidity (CO2) level in the served air space.

ATTENTION!!! This option is only available with the th-Tune control panel in a special configuration, the external humidity or CO2 control sensor with a 0-10 V output signal to be purchased separately.

UNIT CONTROL PANELS

The unit is controlled via the th-Tune or pGD1 control panels.



th-Tune

Button	Functions
mode	Operation mode selection: set the operation mode according to the procedure described on Page 19.
	Fan speed selection: set the desired speed level (Low, High or Medium). While the Automatic Speed Drop mode is enabled the fan speed is set automatically to maintain the supply air temperature above the threshold level.
	Short pressing: time range on/off. Activation is confirmed by a pictogram . Press and hold (for 3 seconds): access to the clock/time range setup menu. Use the knob to choose the necessary option: setting the current date/time: starts blinking. Turn the knob to make the desired setting and press to confirm. TIMEBAND: setting the time range. Press to set the start time and the corresponding temperature setpoint for each time range individually (you may create up to six time ranges). The pictograms show the current status (i.e. Day/Nigh) and the presence or absence of inhabitants in the serviced spaces. Press ESC to exit and return to the standard display mode. ESC: exit. After 10 seconds th-Tune returns to the main menu automatically.
	Controls unit activation/deactivation; in some menus a short pressing has the same function as ESC.
	Enter the desired value and press to confirm.

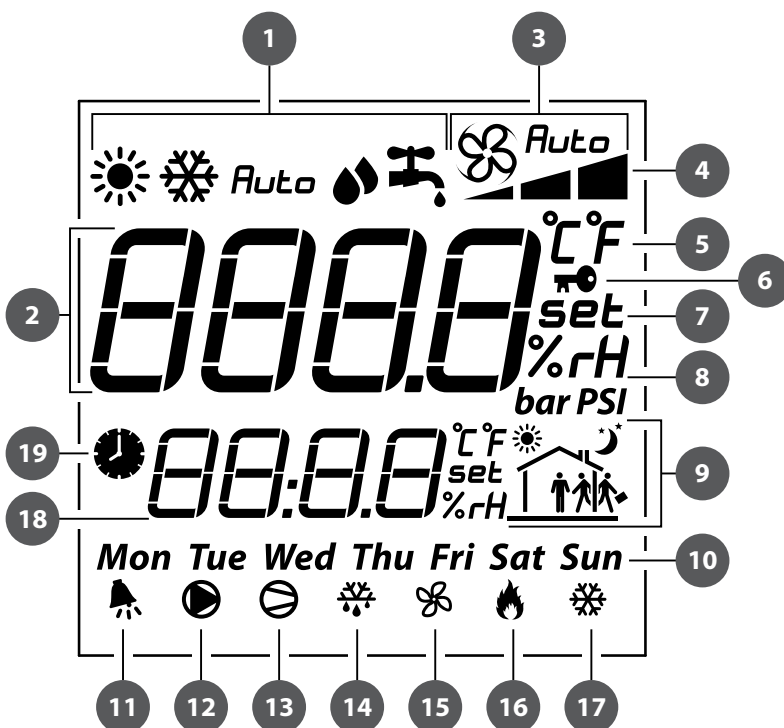

Display pictograms:

1.	Operation mode.
2.	Main field.
3.	Fan mode: Manual/Auto.
4.	Fan speed indicator.
5.	Temperature measurement unit.
6.	Lock function.
7.	Setpoint value.
8.	Relative humidity.
9.	Current time range.
10.	Day of the week.
11.	"Alarm" signal.
12.	Simultaneous blinking with symbol 16 indicates the Warm-up mode or Compressor Protection mode .
13.	Compressor operation.
14.	Defrosting mode signal.
15.	Fan operation signal.
16.	Operation signal of the electric heating elements.
17.	Disabled.
18.	Auxiliary field.
19.	Unit scheduled operation enabled.

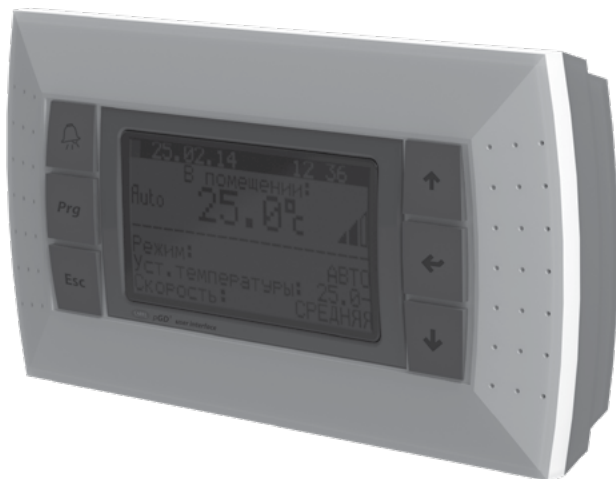

pGD1

The main page of the control panel menu displays the following information:

- date and current time
- indoor temperature (the temperature registered by each sensor can be browsed by pressing the «Up» and «Down» buttons: outdoor temperature, the temperature downstream of the heat exchanger, at the condenser unit and in the exhaust air duct)
- unit operation mode
- temperature setpoint
- selected speed
- scheduled operation on/off

The main page enables access to the user or engineering menu containing extended information specific to the unit operation and detailed parameters for adjustment.

PLAN NETWORK CONFIGURATION WHILE USING AN EXTERNAL CONTROL PANEL (pGD1).

To enable interaction with the control panel boot up the controller in the pLan mode and assign the following pLan addresses to the controller and the control panel:

Controller — 1;

Control panel (pGD1) — 30, 31 or 32 (factory default value).

SETTING PLAN ADDRESS FOR THE CONTROL PANEL (pGD1).

1. Connect the control panel to the controller and power up the controller.
2. Ignore any information which might show on the display screen and simultaneously press the «Up», «Down» and «Enter» buttons and hold them for 3-5 seconds. After this time the message «Display address setting.....32» appears on the display screen.
3. Move the cursor to the address setting field using the «Enter» button. Use the «Up» and «Down» buttons to set the desired address value and press «Enter».

SETTING CONTROLLER PLAN ADDRESS VIA THE BUILT-IN CONTROL PANEL.

1. Power off the controller.
2. Power up the controller and immediately press the «Up» and «Alarm» buttons simultaneously. Hold the buttons pressed until the controller page appears on the screen (wait for about 15 seconds):

```
pLan address: 0
UP: increase
DOWN: decrease
ENTER:save & exit
```

3. Use the «Up» and «Down» buttons to set the device address to 1.
4. Press the «Enter» button within 10 seconds to confirm. Failure to press the button within 10 seconds will cause the controller to close the address setting page automatically while keeping the original address value.
5. Upon confirmation the controller will restart with a new pLan address automatically.

SETTING CONTROLLER PLAN ADDRESS VIA pGD1 CONTROL PANEL.

To set the controller address use the pGD1 panel to set the control panel (pGD1) address to 0. To do this follow the steps described in «**SETTING PLAN ADDRESS FOR THE CONTROL PANEL (pGD1)**» paragraph above. Upon setting the control panel address to zero by using the respective buttons on the external control panel follow the steps described in «**SETTING CONTROLLER PLAN ADDRESS VIA THE BUILT-IN CONTROL PANEL**» paragraph.

After setting the controller address set the pLan address of the control panel (pGD1) to 30, 31 or 32.

CONTROLLER FUNCTIONS AND MENU

The controller has the following controls and indicators:



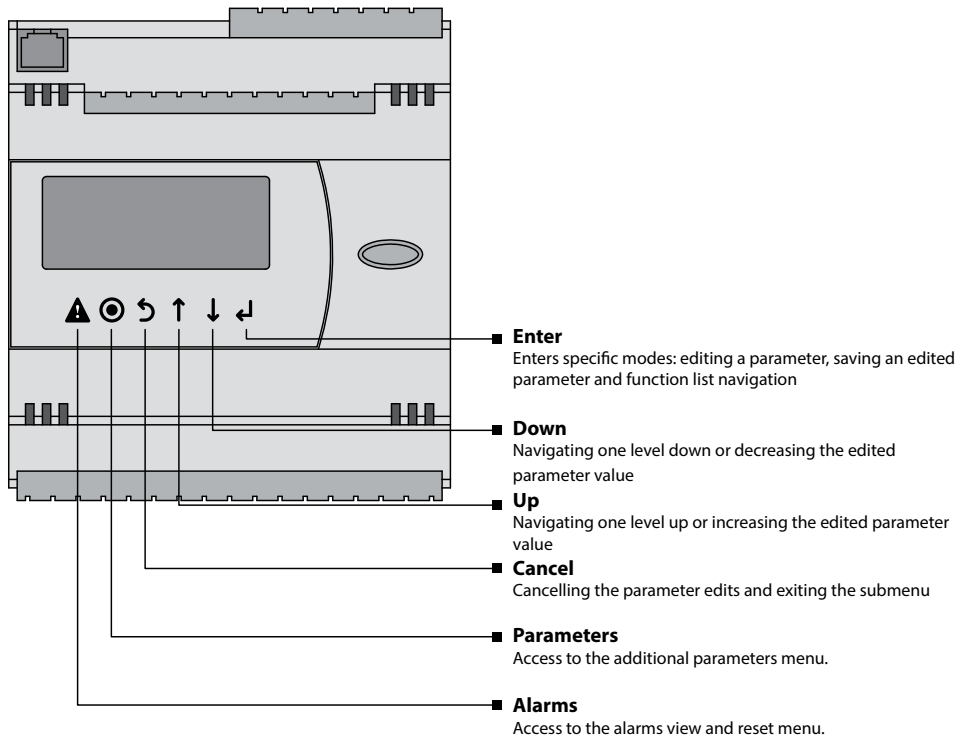

Backlit LCD display. The display screen shows the current parameters of the system operation, temperature values, pre-set parameters and alarms.

Control buttons of the automatic control system:





**THE SERVICE SETTINGS ARE PROGRAMMED AT THE FACTORY.
 THESE SETTINGS MAY BE CHANGED ONLY BY QUALIFIED SPECIALISTS UPON ENTERING
 THE SERVICE PASSWORD.
 CHANGING OTHER PARAMETERS DOES NOT REQUIRE A SERVICE PASSWORD.**

UNIT START	
<p>1. Upon starting the unit choose the controller interface language by using the and buttons and then press .</p>	<p>2. Once the interface language has been selected, the controller firmware will load.</p>
MAIN MENU	
	<ul style="list-style-type: none"> ▪ Current date ▪ Current time ▪ Current temperatures Room temperature Defrosting mode temperature Downstream of the heat exchanger Outside temperature Supply air ▪ Unit operation mode OFF Ventilation Heating Cooling Auto Schedule ▪ The temperature value for the selected mode. <p style="margin-top: 10px;">When using the th-Tune control panel the screen has a different configuration, but all the readings and settings are identical.</p>

To modify the unit operation parameters move the cursor to the required line using the  button. Then use the  and  buttons to set the desired value and then press the  to confirm. To exit the parameter change mode without .

VIEWING THE READINGS FROM THE TEMPERATURE SENSORS, THE HUMIDITY AND CO₂ SENSORS.

To view the readings from the temperature sensors installed in the unit move the cursor to the upper left corner by means of the  button and then use the  and  buttons to select the necessary sensor for viewing.

1. Indoor temperature. The feedback is provided by the temperature sensor built into the control panel or the exhaust duct temperature sensor.

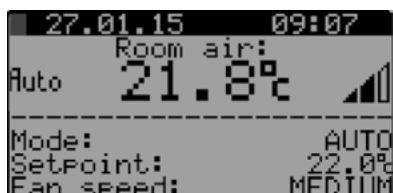

2. Supply air temperature. The feedback is provided by the temperature sensor built into the supply duct downstream of the heat exchanger and the heat-transfer unit.

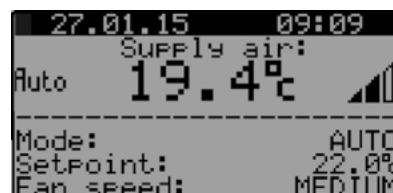

3. Outdoor air temperature. The feedback is provided by the temperature sensor built into the supply duct upstream of the heat exchanger.

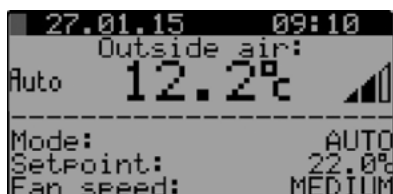

4. Temperature downstream of the heat exchanger. The feedback is provided by the temperature sensor installed in the supply duct downstream of the heat exchanger, but upstream of the heat-transfer unit.

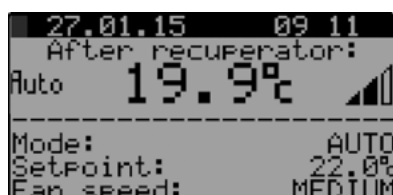





5. Temperature at defrosting sensor. The feedback is provided by the temperature sensor installed on the heat-transfer unit of the exhaust air duct.

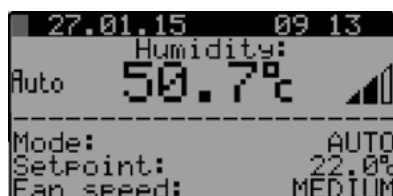

6. Humidity level feedback provided by the humidity sensor in the th-Tune panel or the outdoor sensor.



UNIT OPERATION MODE SELECTION

The unit has 6 operation modes. To select the desired mode set the cursor at the «Mode» word by using the  button. Then use the  and  buttons to set the desired value and then press the  to confirm.

1. OFF— the fans and the heat exchanger are disabled. Temperature and speed settings are not available.



2. FAN— the fans run at the pre-selected speed. The heat exchanger and the heat pump are disabled. The temperature settings are not available. This mode can be enabled only from the pGD1 control panel.

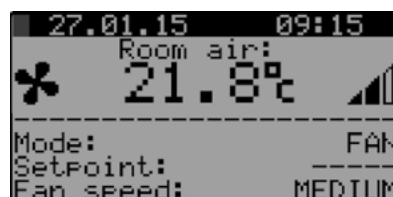

3. Heating — the fans, the heat exchanger and the heat pump are enabled. The user may change the temperature and speed settings. While in the Heating mode the unit operates only to the effect of increasing the indoor temperature up to the pre-set value. If the indoor or the outdoor temperature is inconsistent with this mode settings the unit will switch to the **Auto mode** automatically.

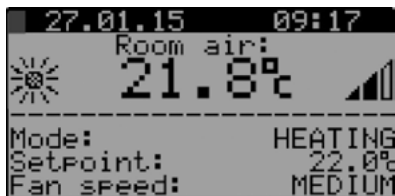

4. Cooling — the fans, the heat exchanger and the heat pump are enabled. The temperature and speed settings are available. While in this mode the unit operates only to the effect of decreasing the indoor temperature to the pre-set value. If the indoor or the outdoor temperature is inconsistent with this mode settings the unit will switch to the **Auto mode** automatically.

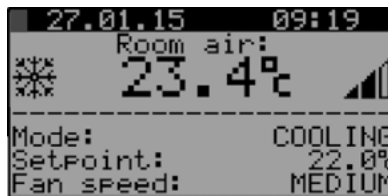

5. Auto — the fans, the heat exchanger and the heat pump are enabled. The temperature and speed settings are available. While in this mode the unit automatically adjusts the heat pump operation to attain the pre-set temperature at the selected speed.

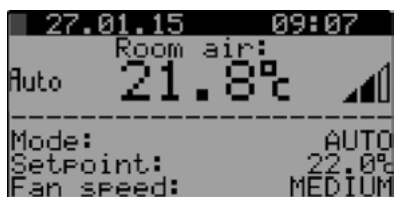

6. Scheduler — the fans, the heat exchanger and the heat pump are enabled. The temperature and speed settings are not available. While in this mode the unit operates according to a pre-programmed schedule.

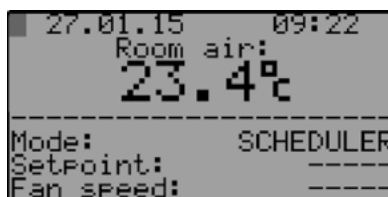

TEMPERATURE SETTING

To modify the temperature setting set the cursor at «Setpoint» by using the button. Then use the and buttons to set the desired value and then press the to confirm. Temperature setting range: from +15 °C to +30 °C.



FAN SPEED SETTING

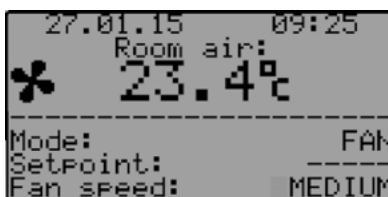

To select the desired fan speed set the cursor at «Fan speed» by using the button. Then use the and buttons to set the desired value and then press the to confirm. Three fan speed stages are available: **Low**, **Medium** and **High**. The fan rotation speed corresponding to each speed stage is set as a percentage of the maximum capacity of each fan via the unit parameter setup menu.

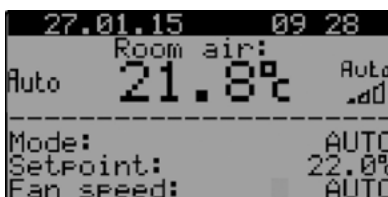

Fan speed control in the **Auto mode** requires a th-Tune control panel in a special configuration or with an external humidity sensor with a 0-10 V output signal. Enable the «**Humidity feedback speed control**» and set the maximum and minimum speed for the supply and exhaust fans as a percentage value. Set the «**Auto**» fan speed.





UNIT PARAMETERS

To enter the user parameter menu press the  button. Use the  and  buttons to select the desired menu item and press the  button to enter.

```
Main menu(user) 1/3
1.System info
2.Set time & scheduler
3.Parameters
```

1. System information

To view the system information enter the user parameter menu and select «**System info**». The «**System info**» menu consists of three pages. To navigate between the pages use the  and  buttons.

```
Main menu(user) 1/3
1.System info
2.Set time & scheduler
3.Parameters
```

Page 1/3 contains the following parameters:

- Current supply fan speed [%].
- Current exhaust fan speed [%].
- Current heat exchanger state:
On — heat exchanger enabled
Off — heat exchanger disabled
- Current compressor state:
On — compressor enabled
Off — compressor disabled
- Current operation mode of the 4-way valve:
On — 4-way valve enabled
Off — 4-way valve disabled
- Recirculation damper opening [%].

```
System info 1/3
Supply fan speed: 079%
Exhaust fan speed: 079%
Energy recovery: ON
Compressor: OFF
4-way valve: OFF
Recirculation: 000%
```

Page 2/3 contains the following parameters:



- Outdoor air temperature [°C]
- Supply air temperature [°C].
- Indoor air temperature [°C].
- Exhaust duct temperature [°C].
- Air temperature downstream of heat exchanger [°C].
- Thawing temperature sensor [°C].
-

```
System info 2/3
Outside air tem: 75.4°C
Supply air temp: 19.4°C
Exhaust air tem: 21.8°C
After ER unit: 19.9°C
Defrost sensor: 19.8°C
```

Page 3/3 contains the controller firmware information:



```
System info 3/3
Software version:
CRUNTMHAT v.1.1.22
```

2. Set time & scheduler

To set the clock and operation schedule enter the user parameters menu and select «**Set time & scheduler**». The «**Set time & scheduler**» menu consists of four pages. To navigate between the pages use the  and  buttons.

Attention! With the th-Tune panel connected the operation schedule is set via the control panel!

```
Main menu(user) 2/3
1.System info
2.Set time & scheduler
3.Parameters
```

Page 1/4 enables setting the unit operation schedule. Press the  button to select the desired parameter and then set its value using the  and  buttons.

```
Scheduler 1/4
Day: MONDAY
Mode Setpoint
1:07:00 AUTO SET1
2:08:00 OFF ----
3:16:10 AUTO SET2
4:23:00 OFF ----
Copy to: MONDAY NO
```

Schedule setup

1. Day selection.

Use the button to select the «Day» parameter and then use the and buttons to select the day for setting the schedule.

```
Scheduler 1/4
Day: MONDAY
Mode Setpoint
1:--:-- ----
2:--:-- ----
3:--:-- ----
4:--:-- ----
Copy to: ALL NO
```

2. Setting the schedule recording start time.

Press the button to start setting the first entry. Then use the and buttons to set the start time for the first entry in hours. After that press the button to set the time in minutes and then use the and buttons to set the minute value.

```
Scheduler 1/4
Day: MONDAY
Mode Setpoint
1:06:00 ----
2:--:-- ----
3:--:-- ----
4:--:-- ----
Copy to: ALL NO
```

3. Operation mode setup.

After setting the time press the button to set the unit operation mode. Use the and buttons to select one of the following modes:

- Disabled
- Ventilation
- Heating
- Cooling
- Auto
- Scheduled operation

```
Scheduler 1/4
Day: MONDAY
Mode Setpoint
1:06:00 AUTO ----
2:--:-- ----
3:--:-- ----
4:--:-- ----
Copy to: MONDAY NO
```

4. Selecting a setpoint.

After setting the operation mode press the button to adjust the setpoint. Use the and buttons to select one of the pre-programmed setpoints. Open the «Set time & scheduler» menu on page 3/3 to define the setpoints on page 4/4.

```
Scheduler 1/4
Day: MONDAY
Mode Setpoint
1:06:00 AUTO SET1
2:--:-- ----
3:--:-- ----
4:--:-- ----
Copy to: MONDAY NO
```

5. Setting up other entries.

Other entries are set up similarly.

```
Scheduler 1/4
Day: MONDAY
Mode Setpoint
1:06:00 AUTO SET1
2:07:00 OFF ----
3:16:00 FANS SET2
4:22:00 OFF ----
Copy to: MONDAY NO
```

6. Copying schedule entries to other days.

After programming all the necessary entries they can be copied to any other day of the week. To do this:

1. Use the button to set the cursor at «Copy to».
2. Use the and buttons to select a day of the week or all days.
3. Press and then use the and buttons to select «Yes».
4. To confirm the copying operation press the button.

```
Scheduler 1/4
Day: MONDAY
Mode Setpoint
1:06:00 AUTO SET1
2:07:00 OFF ----
3:16:00 FANS SET2
4:22:00 OFF ----
Copy to: ALL YES
```

Setting up exception periods

Page 2/4

While in the Scheduled operation mode you may need to create a period of operation to a different set of scheduled settings between two identical entries. This is done by setting exception periods.

Scheduler 2/4			
Start	Stop	Mode	Setp.
---	---	---	---
.	.	.	.
---	---	---	---

Exception period setting.

To select a parameter press the \leftarrow button.

Then use the \uparrow and \downarrow buttons to set the desired value.

Scheduler 2/4			
Start	Stop	Mode	Setp.
09.05	29.05	OFF	---
.	.	.	.
---	---	---	---

Setting up special days

Page 3/4

While in the Scheduler you may need to program a period of unit operation in one of the modes with a special set of parameters. This is done by setting up special days.

Scheduler 3/4			
Spec. days	Mode	Setp.	
D1:--	---	---	---
D2:--	---	---	---
D3:--	---	---	---
D4:--	---	---	---
D5:--	---	---	---
D6:--	---	---	---

1. Setting up the special day date.

Select the «Date» parameter by pressing the \leftarrow button and then use the \uparrow and \downarrow buttons to select the day in the month to designate a special day.

Scheduler 3/4			
Spec. days	Mode	Setp.	
D1:31	---	---	---
D2:--	---	---	---
D3:--	---	---	---
D4:--	---	---	---
D5:--	---	---	---
D6:--	---	---	---

2. Setting up the special day month.

Press the \leftarrow button to select the «Month» parameter and then use the \uparrow and \downarrow buttons to select the month for assigning a special day to.

Scheduler 3/4			
Spec. days	Mode	Setp.	
D1:31.2	---	---	---
D2:--	---	---	---
D3:--	---	---	---
D4:--	---	---	---
D5:--	---	---	---
D6:--	---	---	---

3. Setting up the special day mode.

Select the «Mode» parameter by pressing the \leftarrow button and then use the \uparrow and \downarrow buttons to assign the operation mode to the special day.

Scheduler 3/4			
Spec. days	Mode	Setp.	
D1:31.12	AUTO	---	---
D2:--	---	---	---
D3:--	---	---	---
D4:--	---	---	---
D5:--	---	---	---
D6:--	---	---	---

4. Selecting the special day setpoint.

Press the \leftarrow button to select the «Set.» parameter and then use the \uparrow and \downarrow buttons to select the setpoint required on the special day.

Once done with the special day setup press the \leftarrow button to save the changes. After pressing the \leftarrow button the cursor will jump to the first step of setting the next special day.

Scheduler 3/4			
Spec. days	Mode	Setp.	
D1:31.12	AUTO	SET3	---
D2:--	---	---	---
D3:--	---	---	---
D4:--	---	---	---
D5:--	---	---	---
D6:--	---	---	---

5. Setting up other special days.

Other special days are set up similarly.

Scheduler 3/4			
Spec. days	Mode	Setp.	
D1:31.12	AUTO	SET3	---
D2:04.05	FANS	---	---
D3:06.06	AUTO	SET2	---
D4:09.09	AUTO	SET1	---
D5:--	---	---	---
D6:--	---	---	---



Setting up setpoints

Page 4/4

The setpoints for schedule entries are programmed on page 4/4.

Setting up setpoints.

Press the  button to select a parameter.

Then use the  and  buttons to set the desired parameter value.

You may program up to three entries. Set the fan speed and temperature for each setpoint.

Scheduler		4/4
Setpoints		
#	Fan speed	Temp. Setp.
1	LOW	24.0%
2	MEDIUM	22.3%
3	HIGH	21.0%

UNIT PARAMETER SETUP



To set up the unit parameters enter the user parameters menu and select «Parameters».

The «Parameters» menu consists of four pages. To navigate between the pages use the  and  buttons.

```

Main menu(user) 3/3
1.System info
2.Set time & scheduler
3.Parameters
    
```

Page 1/04. Setting up fan speed.

Use the  button to select the supply or exhaust fan speed as necessary and then press the  and  buttons to set the speed value as a percentage of the maximum speed.

After that press the  button to save the settings.

The «Main sensor» parameter allows changing the temperature measuring location to account for the value and subsequent processing by the firmware.



If the unit serves a number of spaces the parameter value should be set to: «Exh. air»

If the parameter value is selected «in th-Tune», the control panel must be installed in the space supplied by the unit.

```

Parameters
Main sensor:Exh.air
F1.Exh.fan speed1:040%
F2.Sup.fan speed1:040%
F3.Exh.fan speed2:070%
F4.Sup.fan speed2:070%
F5.Exh.fan speed3:100%
F6.Sup.fan speed3:100%
    
```

Page 2/04. Setting up temperature setpoints.

Press the  button to select the temperature setpoint and then use the  and  buttons to define the setpoint value.

After that press the  button to save the settings.

```

Parameters
T1.Fan speed decrease
temp.setpoint:15.0%
T4.Return to normal
speed diff.: 10.0%
    
```

T1 is the setpoint for the supply air temperature at which the unit will switch to a lower speed in case of failure to attain the pre-programmed temperature conditions.

T4 is the temperature increase relative to **T1** for switching to the pre-programmed speed.

Page 3/04. Setting up humidity/CO2 sensor feedback operation.

```

Parameters
Hum.sensor: ThTune
Humidity/CO2 set: 50%
Fans control by hum.:
U1.Sup.min.speed: 040%
U2.Sup.max.speed: 100%
U3.Exh.min.speed: 040%
U4.Exh.max.speed: 100%
    
```

The «Humidity sensor» parameter enables changing the humidity measurement location. To control the humidity level at the control panel mounting location (if the panel is equipped with a humidity sensor) select the «th-Tune» parameter.

If the unit is equipped with an external humidity/CO₂ sensor and the «exhaust air» parameter is selected, the humidity/CO₂ measurements are taken at the sensor mounting location.

The fan speed (if the Auto fan mode is selected) will vary within the parameters defined by setpoints from U1 and U3 to U2 and U4 so that the humidity/CO₂ levels are maintained below the «Humidity/CO₂ set.» threshold value.

Page 4/04. Hour meter operation.

```

Parameters
Recirc.management:AUTO

Reset of operating
hours counter: No
Max.operating time
to filter replacement:
03000hours

```

If the unit is equipped with a recirculation damper the mode can be set to either **Auto** or **Manual**. If the manual mode is selected, set the necessary damper opening angle (30 % by factory default). On elapsing of the filter replacement interval (3,000 hours by default) the system will generate a filter replacement alert. To reset the filter replacement alerts once the filter has been replaced press the button to make the following menu selection: Hour meter reset — «**RESET**». To change the filter replacement alert parameter set the time as desired and press .

ALARMS

In the event of an alarm the controller display shows the pictogram .

```

27.01.15 12 01
Room air:
21.8°C
-----
Mode: OFF
Setpoint: ----
Fan speed: ----

```

To respond to an alarm press the  button to enter the active alarms menu.

```

Active alarms
E02
Outside air temp.(OAT)
sensor fail

```

The controller resets the alarm automatically on detecting that its cause has been eliminated.

```

Active alarms
There are no
active alarms

```



The active alarms can be reset manually. To reset an alarm manually press the  button while in the active alarms menu to enter the alarm management menu.

```

Alarm management
Active alarms:00
Press key:
'←' to view active
alarms list
'⊙' to view history
'▲' to reset alarms

```

The alarm management menu enables the following actions:

-  — viewing the current alarm list;
-  — viewing the alarm history;
-  — reset the alarms.

TECHNICAL MAINTENANCE



DISCONNECT THE UNIT FROM POWER MAINS PRIOR TO ANY MAINTENANCE OPERATIONS WITH THE UNIT.

Maintenance operations of the unit are required 3-4 times per year.

Maintenance includes general cleaning of the unit and the following operations:

1. Filter maintenance:

Dirty filters increase air resistance in the system and reduce supply air volume. The filters require cleaning not less than 3-4 times per year.

On elapsing of 3,000 operating hours the unit controller generates the filter replacement or cleaning alert. Clean or replace the filters and reset the hour meter.

Vacuum cleaning is allowed. After two consecutive cleanings filters must be replaced. For new filters contact the Seller.

SEQUENCE OF FILTER REMOVAL:

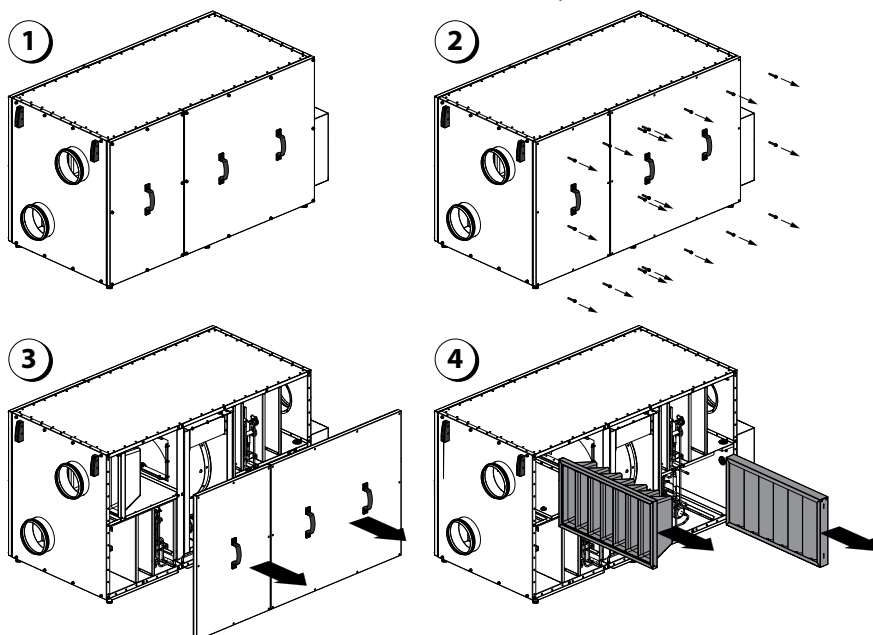

1. Disconnect the unit from power mains.
2. Undo the screws securing the service panels in place.
3. Remove the side panels.
4. Pull the filters to remove.
5. Replace the filters in the reverse order.

2. Heat exchanger maintenance (once per year).

Some dust may accumulate on the heat exchanger block even in case of regular maintenance of the filters. To maintain the high heat recovery efficiency, regular cleaning is required. To clean the heat exchanger remove it from the unit and clean the heat exchanger by using compressed air or a vacuum cleaner. Then install the heat exchanger back to the unit.



CLEAN THE UNIT CAREFULLY SO AS NOT TO DAMAGE THE HEAT EXCHANGER CELLS.

SEQUENCE OF HEAT EXCHANGER REMOVAL:

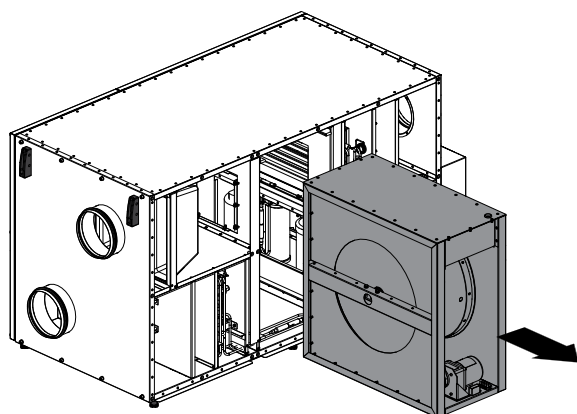

1. Disconnect the unit from power mains.
2. Undo the screws securing the service panels in place.
3. Remove the side panels and then unscrew the angle pieces securing the heat exchanger (except VUT R 400 TN EH EC).
4. Unplug the connector to the heat exchanger motor and remove the grounding terminal.
5. Pull the heat exchanger and remove it from the unit.
6. Re-install the heat exchanger in the reverse order.

3. Heat-transfer unit maintenance

Even in case of regular maintenance of the filters, some dust may accumulate inside the fans and reduce the fan performance and supply air flow.

To clean the heat-transfer units remove the heat exchanger from the unit and blow the heat-transfer units with compressed air or use a vacuum cleaner. After cleaning re-install the heat exchanger into the unit.

4. Fan maintenance (once per year).

Even in case of regular maintenance of the filters, some dust may accumulate inside the fans and reduce the fan performance and supply air flow.

Clean the fans with a soft cloth or brush. Do not use water, aggressive solvents or sharp objects as they may damage the impeller.

5. Condensate drainage maintenance (once per year).

The condensate drainage (drain line) may get clogged by dirt and dust particles contained in the exhaust air. Check the drain line operation by filling the drain pan under the unit with water, clean the U-trap and the drain line, if necessary.

The unit design allows condensate drain pan cleaning. If necessary, the drain pans can be removed for thorough washing.

6. Supply air flow control (twice per year).

The supply duct grille may get clogged with leaves and other objects reducing the unit performance and supply air delivery. Check the supply grille twice per year and clean it as required.

7. Ductwork system maintenance (once in 5 years).

Even regular fulfilling of all the prescribed above maintenance operations may not completely prevent dirt accumulation in the air ducts which leads to air pollution and reduces the unit capacity. Duct maintenance means regular cleaning or replacement.

TROUBLESHOOTING

POSSIBLE FAULTS AND TROUBLESHOOTING

Problem	Possible reasons	Спосіб усунення
Fan(s) will not start on unit power-up.	No power supply.	Make sure the power supply line is connected correctly, otherwise troubleshoot a connection error.
	Motor jammed, impeller blades dirty.	Turn the unit off. Troubleshoot the motor jam and the impeller clogging. Clean the blades. Restart the unit.
	System alarm.	Identify the system failure by entering the active alarms menu and remedy the problem. If the system failure may not be remedied without enlisting expert help contact the Seller.
	Unit in Defrosting mode.	While in the Defrosting mode the fans are disabled.
Abnormal noise or vibration.	High current consumption caused by a short circuit.	Turn the unit off. Contact the Seller.
Water leakage.	Fan speed set too low.	Set higher speed.
	Filters, fans or heat exchanger dirty.	Clean or replace the filters, clean the fans and the heat exchanger.
	Ventilation system elements (air ducts, diffusers, louver shutters, grilles) clogged, damaged or closed.	Clean or replace the ventilation system elements, such as air ducts, diffusers, louver shutters, grilles.
Холодный приточный воздух.	Exhaust filter dirty.	Clean or replace the extract filter.
	Unit in Cooling mode.	Check the unit operation settings.
	Heat pump malfunction.	Turn the unit off. Contact the Seller.
Повышенный шум, вибрация.	Impeller(s) dirty.	Clean the impeller(s).
	Compressor damaged.	Turn the unit off. Contact the Seller.
	Loose screw fastenings of fan or casing.	Tighten the screw connection of the fans or the casing against stop.
	No anti-vibration connector on air duct pipe flanges.	Install anti-vibration connectors.
Утечка воды.	Drain pipe clogged, damaged or improperly installed.	Clean the drain line. Check the drain line slope angle. Make sure that the U-trap is filled with water and the drain pipes are frost protected.
Авария по давлению	Unit operation outside the permissible temperature range.	Ensure proper temperature at the unit mounting location.
	Insufficient air flow rate.	See "Alarm": low air flow.
	Pressure sensor failure.	Turn the unit off. Contact the Seller.
	Refrigerant agent level too low.	Turn the unit off. Contact the Seller.

STORAGE AND TRANSPORTATION REGULATIONS

Store the unit in the manufacturer's original packing box in a dry closed ventilated premise with temperature range from +5 °C to +40°C. Storage environment must not contain aggressive vapours and chemical mixtures provoking corrosion, insulation and sealing deformation. Use hoist machinery for handling and transportation to prevent possible mechanical damages of the unit.



**THE UNIT MAY NOT BE INCLINED MORE THAN 45 DEGREES
IN RELATION TO HORIZON.**

Follow the applicable moving regulations specific to the particular cargo type while loading and unloading.

The unit can be transported in the original packing by any mode of transport without limitation provided proper protection against precipitation and mechanical damage. The unit can be transported only in the working position.

Avoid sharp blows, scratches or rough handling during loading and unloading.

Prior to the initial power-up after transportation at subzero temperatures allow the unit to warm up at room temperature for at least 3-4 hours.

MANUFACTURER'S WARRANTY

The manufacturer hereby warrants normal operation of the unit for 24 months after the retail sale date provided the user's observance of the transportation, storage, mounting and operation regulations.

Should any malfunctions occur in the course of the unit operation through the Manufacturer's fault during the guaranteed period of operation the user is entitled to elimination of faults by the manufacturer by means of warranty repair at the factory free of charge.

The warranty repair shall include work specific to elimination of faults in the unit operation to ensure its intended use by the user within the guaranteed period of operation. The faults are eliminated by means of replacement or repair of the unit components or a specific part of such unit component.

The warranty repair does not include:

- routine technical maintenance
- unit installation / dismantling
- unit setup.

To benefit from warranty repair the user must provide the unit, the user's manual with the purchase date stamp and the payment document certifying the purchase.

The unit model must comply with the one stated in the user's manual.

Contact the Seller for warranty service.

The manufacturer's warranty does not apply to the following cases:

- User's failure to submit the unit with the entire delivery package as stated in the user's manual including submission with missing component parts previously dismantled by the user.
- Mismatch of the unit model and the brand name with the information stated on the unit packing and in the user's manual.
- User's failure to ensure timely technical maintenance of the unit.
- External damage to the unit casing (excluding external modifications as required for installation) and internal components caused by the user.
- Redesign or engineering changes to the unit.
- Replacement and use of any assemblies, parts and components not approved by the manufacturer.
- Unit misuse.
- User's violation of the unit installation regulations.
- User's violation of the unit control regulations.
- Unit connection to the power mains with a voltage different from the one stated in the user's manual.
- Unit breakdown due to voltage surges in the power mains.
- Discretionary repair of the unit by the user.
- Unit repair by any persons without the manufacturer's authorization.
- Expiration of the unit warranty period.
- User's violation of the unit transportation regulations.
- User's violation of the unit storage regulations.
- Wrongful actions against the unit committed by third parties.
- Unit breakdown due to circumstances of insuperable force (fire, flood, earthquake, war, hostilities of any kind, blockades).
- Missing seals if provided by the user's manual.
- Failure to submit the user's manual with the unit purchase date stamp.
- Missing payment document certifying the unit purchase.



**FOLLOWING THE REGULATIONS STIPULATED HEREIN WILL ENSURE
A LONG AND TROUBLE-FREE OPERATION OF THE UNIT.**



**USERS' WARRANTY CLAIMS SHALL BE SUBJECT TO REVIEW ONLY
UPON PRESENTATION OF THE UNIT, THE PAYMENT DOCUMENT AND THE USER'S
MANUAL WITH THE PURCHASE DATE STAMP.**

ACCEPTANCE CERTIFICATE

Unit Type	Heat recovery air handling unit
Model	KOMFORT ROTO EC L(E)HP_____
Serial Number	
Manufacture Date	
<p>We hereby declare that the product complies with the essential protection requirements of Electromagnetic Council Directive 2004/108/EC, 89/336/EEC and Low Voltage Directive 2006/95/EC, 73/23/EEC and CE-marking Directive 93/68/EEC on the approximation of the laws of the Member States relating to electromagnetic compatibility. This certificate is issued following test carried out on samples of the product referred to above.</p>	
Quality Inspector's Stamp	

SELLER INFORMATION

Seller	
Address	
Phone Number	
E-mail	
Purchase Date	
<p>This is to certify acceptance of the complete unit delivery with the user's manual. The warranty terms are acknowledged and accepted.</p>	
Customer's Signature	

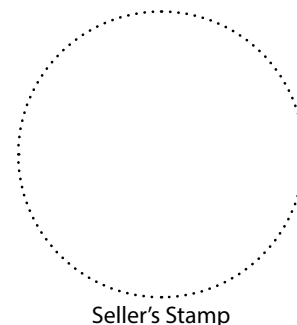

INSTALLATION CERTIFICATE

<p>KOMFORT ROTO EC L(E)HP_____ heat recovery air handling unit has been connected to power mains pursuant to the requirements stated in the present user's manual.</p>	
Company Name	
Address	
Phone Number	
Installation Technician's Full Name	
Installation Date:	Signature:
<p>The unit has been installed in accordance with the provisions of all the applicable local and national construction, electrical and technical codes and standards. The unit operates normally as intended by the manufacturer.</p>	
Signature:	

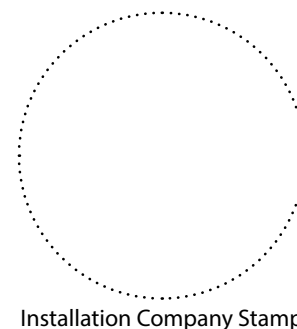

WARRANTY CARD WARRANTY CARD

Unit Type	Heat recovery air handling unit
Model	KOMFORT ROTO EC L(E)HP _____
Serial Number	
Manufacture Date	
Purchase Date	
Warranty Period	
Seller	

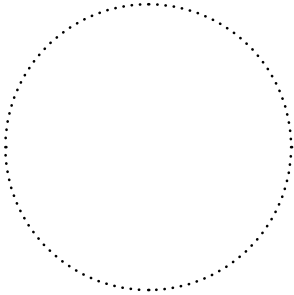

Seller's Stamp

A large rectangular area with a light gray border, containing ten horizontal lines for text entry. A small circular logo is located in the bottom right corner of this area.



BLAUBERG
Ventilatoren

