



AXIAL FAN



EN

Cabrio Base 100

USER'S MANUAL

CONTENTS

Brief description	6
Operation guidelines	6
Designation key	7
Mounting.....	7
Fun setup.....	8
Maintanance.....	9
Storage and transportation regulations	9
Manufacturer's warranty	10

This user's manual is a main operating document intended for technical, maintenance, and operating staff. The manual contains information about purpose, technical details, operating principle, design, and installation of the Cabrio Base 100 unit and all its modifications.

Technical and maintenance staff must have theoretical and practical training in the field of ventilation systems and should be able to work in accordance with workplace safety rules as well as construction norms and standards applicable in the territory of the country.

The information in this user's manual is correct at the time of the document's preparation.

The Company reserves the right to modify the technical characteristics, design, or configuration of its products at any time in order to incorporate the latest technological developments.

No part of this publication may be reproduced, stored in a retrieval system, or transmitted, in any form or by any means in any information search system or translated into any language in any form without the prior written permission of the Company.



**READ THE USER'S MANUAL CAREFULLY BEFORE PROCEEDING WITH INSTALLATION WORKS.
COMPLIANCE WITH THE MANUAL REQUIREMENTS ENSURES RELIABLE OPERATION AND LONG
SERVICE LIFE OF THE UNIT.
KEEP THE USER'S MANUAL AVAILABLE AS LONG AS YOU USE THE UNIT. YOU MAY NEED TO RE-
READ THE INFORMATION ON THE PRODUCT SERVICING.**



FOLLOW THE USER'S MANUAL REQUIREMENTS TO ENSURE DURABLE AND TROUBLE-FREE OPERATION OF THE UNIT.

Disconnect the unit from power supply prior to any connection, servicing, maintenance, and repair operations.

Only qualified electricians with a work permit for electrical units up to 1000 V are allowed for installation and maintenance. The present user's manual should be carefully read before beginning works.

- Single-phase power mains must comply with the acting local electrical norms and standards.
- Fixed electrical wiring must be equipped with an automatic circuit breaker.
- The unit must be connected to power mains through a QF automatic circuit breaker integrated into the fixed wiring system. The gap between the circuit breaker contacts on all poles must be not less than 3 mm. Check the unit for any visible damages of the impeller and the casing before starting installation. The casing internals must be free of any foreign objects that can damage the impeller blades.
- While mounting the unit, avoid compression of the casing! Deformation of the casing may result in the motor jam and noisy operation. Misuse of the unit and any unauthorised modifications are not allowed.
- Take steps to prevent ingress of smoke, carbon monoxide, and other combustion products into the room through open chimney flues or other fire-protection devices. Sufficient air supply must be provided for proper combustion and exhaust of gases through the chimney of fuel burning equipment to prevent back drafting. Transported air must not contain any dust or other solid

impurities, sticky substances, or fibrous materials.

- Do not use the unit in a hazardous or explosive environment containing spirits, gasoline, insecticides, etc.
- Do not close or block the intake or extract vents in order to ensure the efficient air flow.
- Do not sit on the unit and do not put objects on it.
- The unit is allowed to be used by children aged from 8 years old and above and persons with reduced physical, sensory, or mental capabilities or no experience and knowledge provided that they have been given supervision or instruction regarding safe use of the unit and understand the risks involved.
- Do not allow children to play with the unit.



**THE PRODUCT MUST BE DISPOSED SEPARATELY AT THE END OF ITS SERVICE LIFE.
DO NOT DISPOSE THE UNIT AS UNSORTED DOMESTIC WASTE.**



DELIVERY SET

Fan	- 1 pc.
Screws with dowels	- 4 pcs.
Plastic screwdriver	- 1 pc. (only for the models with a timer)
User's manual	- 1 pc.
Packing box	- 1 pc.

BRIEF DESCRIPTION

The products described herein is an axial fan for exhaust ventilation of small to medium-sized premises heated during winter. The fan is designed for connection to 100 mm air ducts. The integrated backdraft damper prevents air backdrafting when the fan is off.

OPERATION GUIDELINES

The fan is rated for connection to AC single-phase. The power mains parameter are stated on the packing box and/or on the sticker on the fan casing.

Air motion direction in the system must match the pointer on the fan casing.

Hazardous parts access and water ingress protection rating is IP45.

The fan is rated for operation at the ambient temperature ranging from +1 °C up to +45 °C. The unit is rated as a Class II electrical appliance.

DESIGNATION KEY

Cabrio Base V2 100 X (220-240 V/60 Hz)

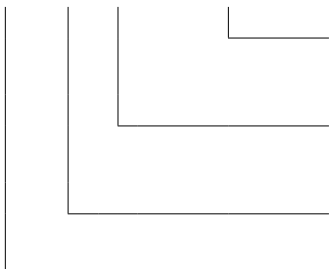

Voltage:

___ : 220-240 V/50 Hz
 220-240 V/60 Hz : voltage 220-240 V, frequency 60 Hz

Extra options:

T : turn-on delay timer, turn-off delay timer and interval timer
H : humidity sensor, turn-on and turn-off delay timer

Exhaust spigot diameter [mm]

Base : single-speed motor
Base V2 : two-speed motor

MOUNTING

The fan is designed for wall mounting and connection to a ventilation shaft or a round air duct of a matching diameter (Fig. 2).

Mounting steps:

- Step 1.** Cut off power supply and make sure that the power is disconnected (Fig. 3).
- Step 2.** Route the power cable to the vent (Fig. 4).
- Step 3.** Disconnect the front panel from the fan. Then remove the cover that covers the terminal block (Fig. 5).
- Step 4.** Mark and bore the fastening holes and install the fan (Fig. 6-8).
- Step 5.** Connect the fan to power supply in compliance with the wiring diagram (Fig. 12-16).
- Step 6.** Install the cover that closes the terminal block (Fig. 9) and the front panel on the fan casing (Fig. 10).
- Step 7.** Provide power supply to the fan (Fig. 11).

Designation of the terminals on the wiring diagrams:

L: live
N: neutral
S: external switch

QF: circuit breaker

FAN SETUP

 **H**: to adjust the humidity set point turn the control knob **H** clockwise to increase and counter-clockwise to decrease the humidity sensor set point, adjustable from 60% up to 90%.

 **T_i**: turning of the interval timer on and its adjustment is performed with the potentiometer **T_i**. To turn the interval timer off, set the potentiometer **T_i** into the leftmost position. Rotation of the potentiometer for 1/3 clockwise sets the interval timer operation for 6 hours, rotation of the potentiometer for 2/3 clockwise sets the interval timer operation for 12 hours, rotation of the potentiometer clockwise in the rightmost position sets the interval timer operation for 24 hours.

 **T_{off}**: to adjust the fan turn-off delay time, turn the control knob **T_{off}** clockwise to increase and counter-clockwise to decrease the turn-off delay time respectively, adjustable from 2 up to 30 minutes.

Attention! If the switch opens within 60 seconds after its closing, the fan operating status does not change.

Attention! After closing of the switch S the front panel opens within 1 minute. After opening of the switch S (for basic model) or after countdown of the turn-off delay time (for T and H models) the front panel closes within 1 minute.



DO NOT USE A METAL SCREWDRIVER, KNIFE, ETC. FOR ADJUSTMENT OPERATIONS NOT TO DAMAGE THE CIRCUIT BOARD.

The fan delivery set includes a specially designed plastic screwdriver for fan settings adjustments.

Use it for setting the on-delay time, off-delay time and humidity setpoint.

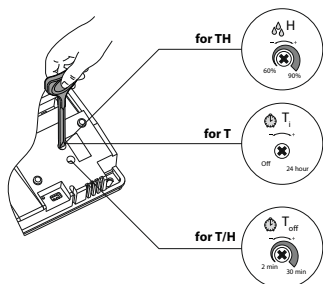

MAINTANANCE

The fan maintenance periodicity is at least once per 6 months.

Maintenance steps:

- Cut off power supply to the fan and make that the power is disconnected (Fig. 17).
- Take off the front panel and clean the fan with a soft dry cloth or a brush (Fig. 18).
- Rinse the front panel with running water (Fig. 19).
- Wipe the fan surfaces dry.
- Cover the fan with the front panel.
- Provide power supply (Fig. 20).

WARNING! Avoid water dripping on the electric components.

WARNING! Avoid water dripping on the electric components.

STORAGE AND TRANSPORTATION REGULATIONS

- Store the unit in the manufacturer's original packaging box in a dry closed ventilated premise with temperature range from +5 °C to +40 °C and relative humidity up to 70 %.
- Storage environment must not contain aggressive vapours and chemical mixtures provoking corrosion, insulation, and sealing deformation.
- Use suitable hoist machinery for handling and storage operations to prevent possible damage to the unit.
- Follow the handling requirements applicable for the particular type of cargo.
- The unit can be carried in the original packaging by any mode of transport provided proper protection against precipitation and mechanical damage. The unit must be transported only in the working position.
- Avoid sharp blows, scratches, or rough handling during loading and unloading.
- Prior to the initial power-up after transportation at low temperatures allow the unit to warm up at room temperature for at least 3-4 hours.



MANUFACTURER'S WARRANTY

The product is in compliance with EU norms and standards on low voltage guidelines and electromagnetic compatibility. We hereby declare that the product complies with the provisions of Electromagnetic Council Directive 2014/30/EU, Low Voltage Directive 2014/35/EU and CE-marking Directive 93/68/EEC. This certificate is issued following test carried out on samples of the product referred to above.

The manufacturer hereby warrants normal operation of the unit for 60 months after the retail sale date provided the user's observance of the transportation, storage, installation, and operation regulations. Should any malfunctions occur in the course of the unit operation through the Manufacturer's fault during the guaranteed period of operation, the user is entitled to get all the faults eliminated by the manufacturer by means of warranty repair at the factory free of charge. The warranty repair includes work specific to elimination of faults in the unit operation to ensure its intended use by the user within the guaranteed period of operation. The faults are eliminated by means of replacement or repair of the unit components or a specific part of such unit component.

The warranty repair does not include:

- routine technical maintenance
- unit installation/dismantling
- unit setup

To benefit from warranty repair, the user must provide the unit, the user's manual with the purchase date stamp, and the payment paperwork certifying the purchase. The unit model must comply with the one stated in the user's manual. Contact the Seller for warranty service.

The manufacturer's warranty does not apply to the following cases:

- User's failure to submit the unit with the entire delivery package as stated in the user's manual including submission with missing component parts previously dismantled by the user.
- Mismatch of the unit model and the brand name with the information stated on the unit packaging and in the user's manual.
- User's failure to ensure timely technical maintenance of the unit.
- External damage to the unit casing (excluding external modifications as required for installation) and internal components caused by the user.
- Redesign or engineering changes to the unit.

- Replacement and use of any assemblies, parts and components not approved by the manufacturer.
- Unit misuse.
- Violation of the unit installation regulations by the user.
- Violation of the unit control regulations by the user.
- Unit connection to power mains with a voltage different from the one stated in the user's manual.
- Unit breakdown due to voltage surges in power mains.
- Discretionary repair of the unit by the user.
- Unit repair by any persons without the manufacturer's authorization.
- Expiration of the unit warranty period.
- Violation of the unit transportation regulations by the user.
- Violation of the unit storage regulations by the user.
- Wrongful actions against the unit committed by third parties.
- Unit breakdown due to circumstances of insuperable force (fire, flood, earthquake, war, hostilities of any kind, blockades).
- Missing seals if provided by the user's manual.
- Failure to submit the user's manual with the unit purchase date stamp.
- Missing payment paperwork certifying the unit purchase.



FOLLOWING THE REGULATIONS STIPULATED HEREIN WILL ENSURE A LONG AND TROUBLE-FREE OPERATION OF THE UNIT.



USER'S WARRANTY CLAIMS SHALL BE SUBJECT TO REVIEW ONLY UPON PRESENTATION OF THE UNIT, THE PAYMENT DOCUMENT AND THE USER'S MANUAL WITH THE PURCHASE DATE STAMP.

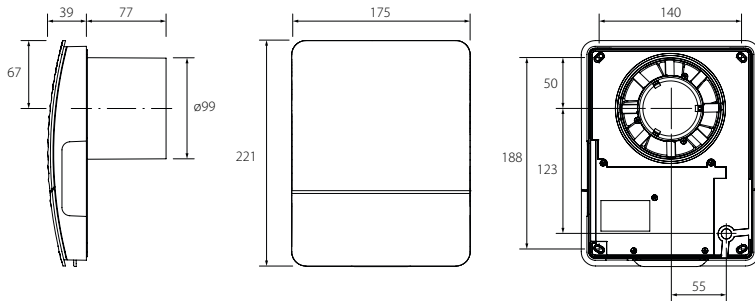

1.

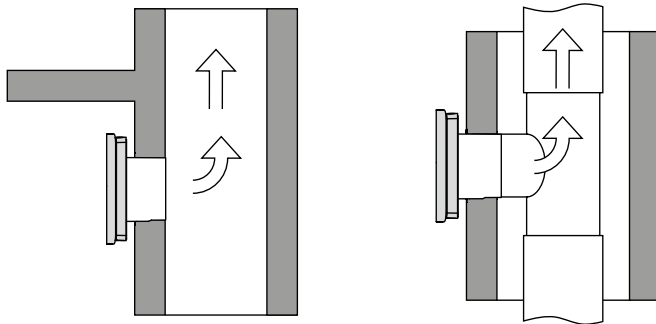

2.

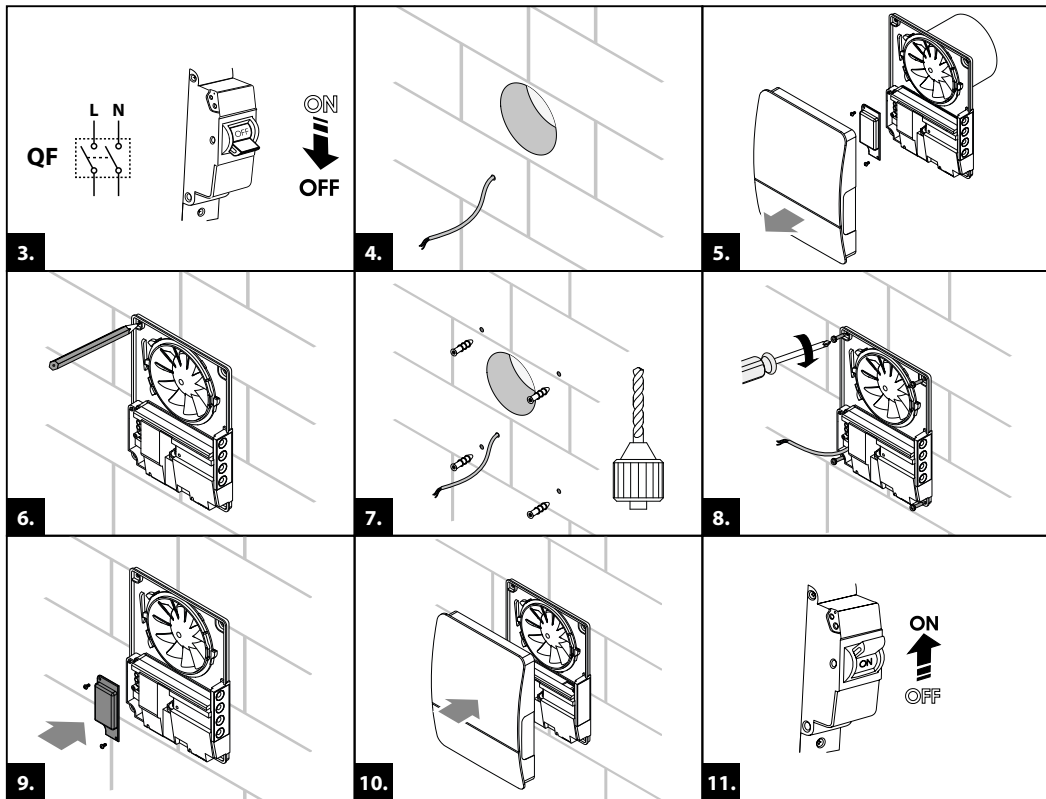

Cabrio Base 100

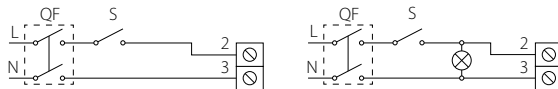

12.

Cabrio Base 100 T

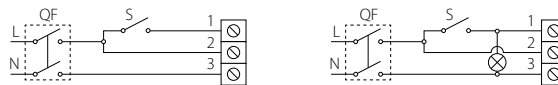

13.

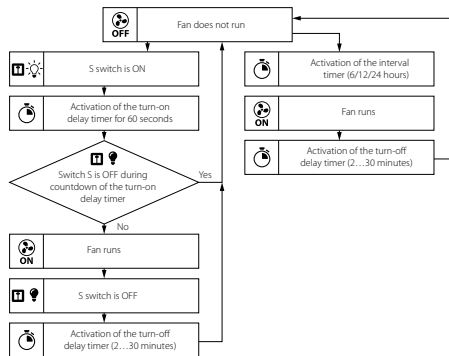

Cabrio Base V2 100 T

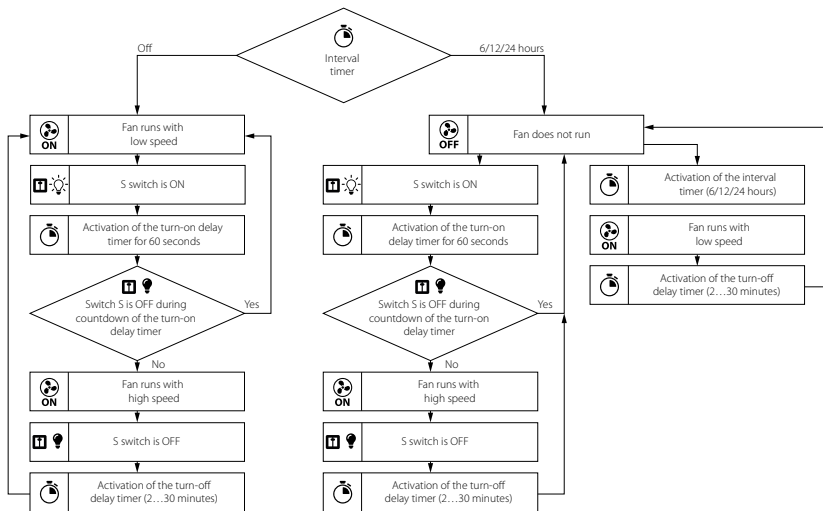
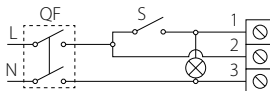
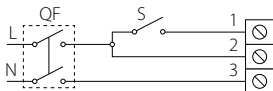

Cabrio Base 100 H

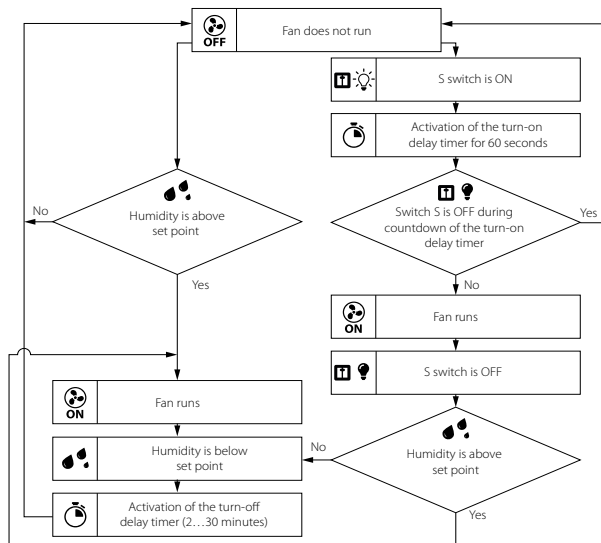
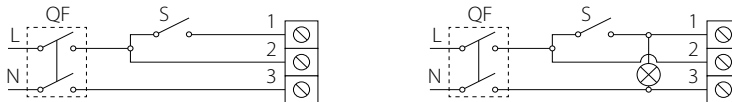

Cabrio Base V2 100 H

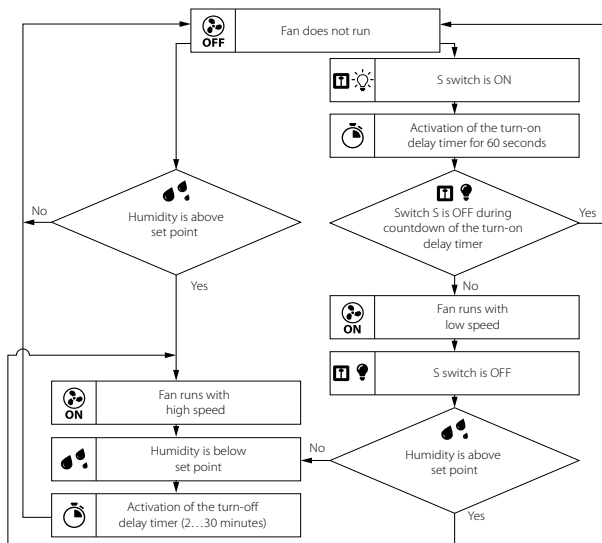
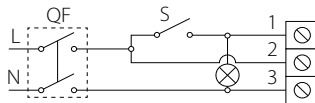
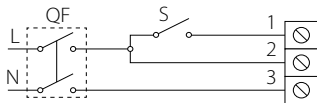

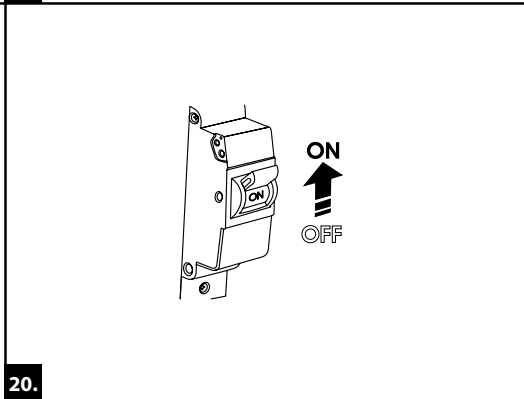
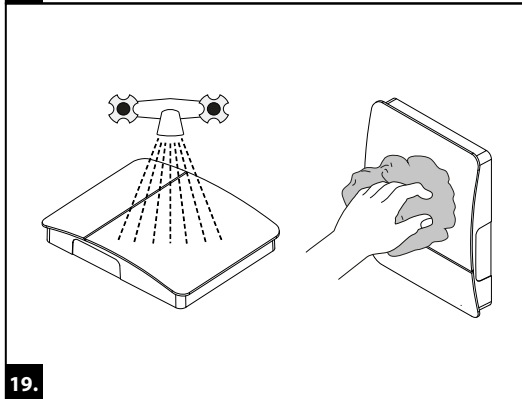
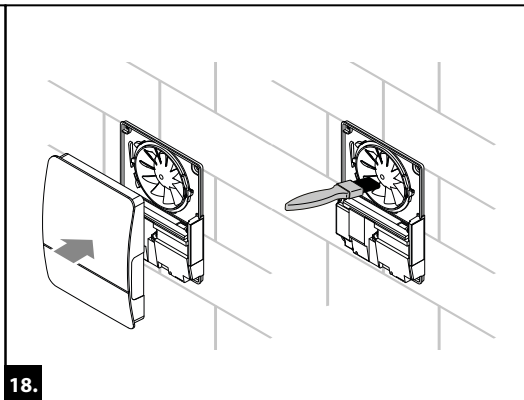
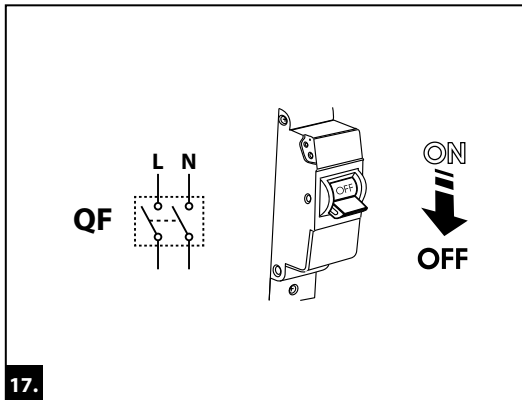

Quality Inspector's Stamp

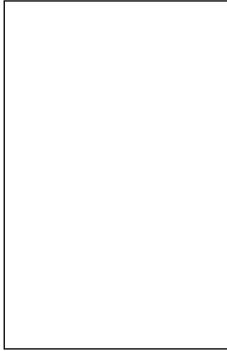
A large, empty rectangular box with a thin black border, intended for a quality inspector's stamp.

Seller
(name and stamp of the seller)

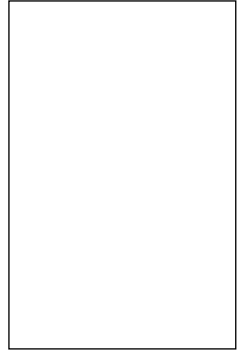
A large, empty rectangular box with a thin black border, intended for the seller's name and stamp.

Manufacture Date

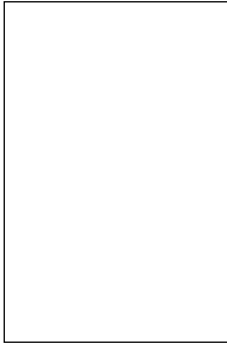
A large, empty rectangular box with a thin black border, intended for the manufacture date.

Purchase Date

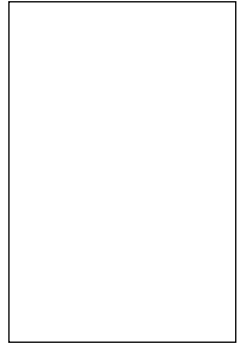
A large, empty rectangular box with a thin black border, intended for the purchase date.

Base T 220-240 V
60 Hz

Cabrio 100

Base V2 H

