



RESIDENTIAL VENTILATION

CONTENTS

Intelligent fans



SMART Wi-Fi 6

Silent & energy saving



CABRIO BASE 8



CABRIO BASE V2 10



SILEO / SILEO MAX 12



SILEO V2 13



SILEO DC 14



SILEO DESIGN 16



SILEO DESIGN V2 17



TRIO 18



TRIO V2 20

Silent & energy saving



AERO STILL 22



BRAVO STILL 23

Design Konzept system



DESIGN KONZEPT SYSTEM 24



OMEGA 25



DECOR FB 140X140 S 26



DPK 100 26

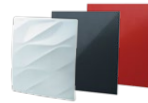

DECORATIVE PANELS 27

With decorative front panel



MOON 28



HI-FI 30



BAVARIA 32



With decorative front panel

	QUATRO	34
---	--------	----



Classic models

	AUTO	36
	AERO	37
	BRAVO	38
	SLIM	39
	LINE	40
	JET	41
	DECO	42

In-line fans

	TUBO	43
	DUCTO	44

Window fans

	WIND	46
	WIND-K	47

Centrifugal fans

	CEILEO	48
	CEILEO DC	52
	CEILEO COMPACT	56
	CEILEO COMPACT DC	60
	VALEO	64
	VALEO-BP	70
	VALEO-E	74
	FORCE / FORCE MAX	78

CONTENTS

Wall vents

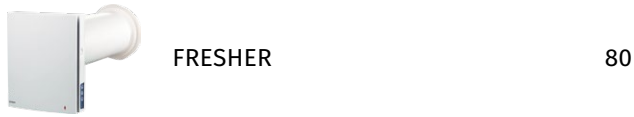

Wall vents with solar panel



Window vents

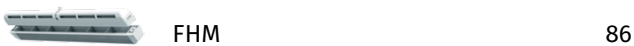

Heat transfer kits

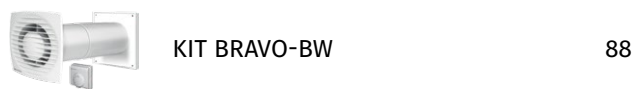

Metal hoods

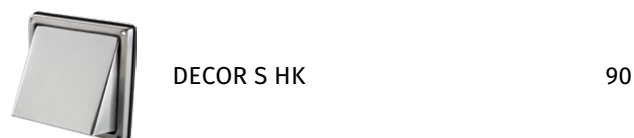

Plastic hoods



Plastic gravity grilles



Metal gravity grilles



Metal grilles

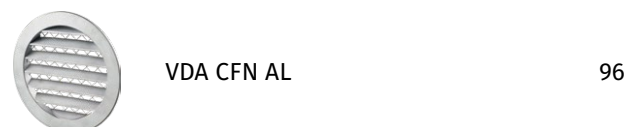
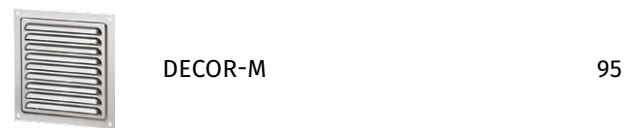

Plastic grilles



Plastic grilles Plastic grilles



Plastic door grilles

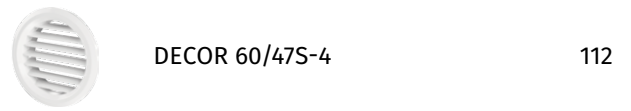

Metal air disc valves

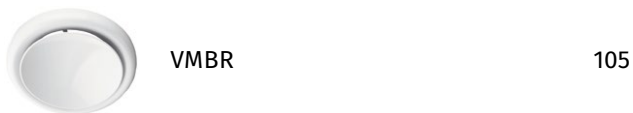

Access doors



Plastic air disc valves



Aluminium door grilles



Plastic door grilles

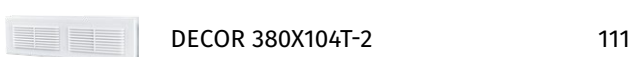



Thyristor speed controllers



CONTENTS

Multi-speed switches

	SGR-3/1	123
	CDP-2/5 / CDP-3/5	124
	CDP-2/10	125
	CDPI-2(3) E5 / CDPE-2(3) E5	126

Control units for fans

	MCD 60/0.3	127
---	------------	-----



Room thermostats

	TS E10	128
---	--------	-----

Room temperature regulators

	MLC E2 / MLCD E2	129
---	------------------	-----

Step-down transformers

	AT-25 220/12	130
	ATK-25 220/12	131

Round plastic duct system

	BLAUPLAST	132
---	-----------	-----



Flat plastic duct system

	BLAUPLAST	138
---	-----------	-----

Round and flat folding PVC duct system

	BLAUPLAST RRF/FKF	144
---	-------------------	-----

Flexible air ducts

	BLAUFLEX ISO N	145
	BLAUFLEX	146

Fittings for round air ducts

	FITTINGS	148
---	----------	-----

SMART Wi-Fi

INTELLIGENT FANS

Smart exhaust fans with stylish design for enhanced comfort in bathrooms, shower rooms, kitchens and with Wi-Fi control from a smartphone



Air flow:
up to 133 m³/h
37 l/s



Power:
from 1.6 W

SFP:
from 0.13 W/l/s



Noise level:
from 17 dBA



Savanna



Cosmos
Black



Royal
Granit



Brilliant
Red



Platinum



Vulcan
Grey



Madeira

Features



- Intelligent electronics and integrated functions for the ideal micro-climate.
- High air flow up to 133 m³/h and silent operation due to a specially designed motor and aerodynamic profiled impeller.
- High-efficient DC motor with low energy demand and reliable non-stop operation rated for above 50 000 hours.
- Impulse-type power supply unit with a wide power supply range from 100 to 240 V, 50/60 Hz provides stable operation in electrical grids with versatile power supply standards.
- The fan has automatic power shutoff function in case of the motor jam.
- Low noise level due to specially designed fixation of the motor and the impeller on a vibration absorbing mount.
- The built-in slide switch makes it easy to disconnect the fan from power mains for safe operation.
- Ultrathin casing with 28 mm thickness.
- Versatile mounting – vertical or horizontal installation.
- Replaceable connecting piece for connection to Ø 100 or 125 mm air ducts.

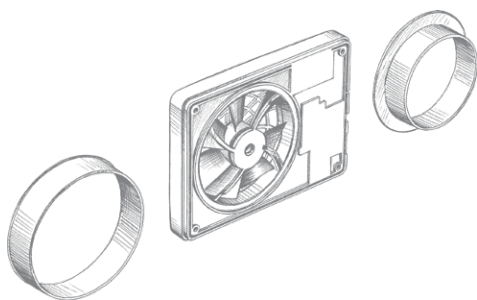

- For convenient maintenance, the motor with the impeller can be easily removed from the casing without special tools.

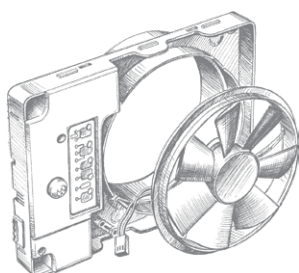

Modes and functions

- The operating mode for the Smart Wi-Fi fan can be selected using the **Blauberg Fan** application for Android or iOS.



INTELLIGENT HUMIDITY SENSOR

The fan has an integrated intelligent humidity sensor with the following operation modes:

Auto – intelligent humidity control.

It provides for humidity threshold change and fan speed selection automatically. The fan independently selects the optimum humidity threshold for the room in which it is installed. Fan operation algorithm is selected based on analysing the statistical data of indoor humidity level.

Manual mode allows setting the humidity threshold in range from 40 % to 80 %. If this threshold is exceeded, the fan turns on or switches to a higher speed.



AUTOMATIC OPERATION BASED ON TEMPERATURE SENSOR

If the air temperature exceeds the set point, the fan will switch to Max speed and will return to the previous mode only after the indoor temperature drops by 4 °C below the set point.

SMART Wi-Fi

INTELLIGENT FANS



TIMER

The fan is equipped with two different timers to provide maximal comfort:

- **Turn-on delay timer** allows to delay switching to a higher speed for 2 or 5 minutes after sensor activation.
- **Turn-off delay timer** is designed to prolong the fan operation for 5, 15, 30 or 60 minutes in the mode caused by sensor activation or Boost mode activation.



24 HOURS

24 hours – permanent low-speed operation mode.

Do not disturb – the function is only available when the 24 hours mode is activated. This function allows for setting the time interval so that the fan will not respond to sensors or switch actuation, and will operate at minimum speed in this mode.



INTERVAL VENTILATION

Automatic interval ventilation (function is only available when the **24 hours** mode is deactivated). This mode allows ventilating the room every 12 hours for 30 minutes at the set speed.



SMOOTH SPEED CONTROL

The fan has an integrated smooth speed control function:

- **Silent** – fan operation mode, which is activated after the signal from the motion sensor or external switch. The speed in the Silent mode can be adjusted in the range from 30 % to 100 % of the fan maximum performance.
- **Max (Boost Mode)** – fan operation mode, which is activated when the humidity threshold is exceeded. The speed of this mode can be adjusted in the range from 30 % to 100 % of the maximum performance.



MOTION SENSOR (FOR SMART IR Wi-Fi)

When the motion sensor is activated the turn-on delay timer is switched on. Then the fan will switch to Silent speed. Once there is no motion detected, and after turn-off delay time the fan will switch to standby mode.

Overall dimensions

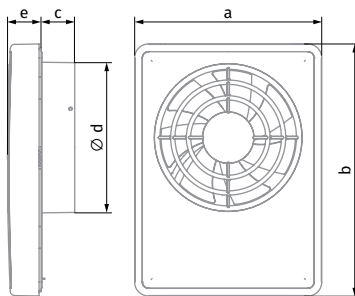

Dimensions [mm]	a	b	c	Ø d	e
Smart Wi-Fi / Smart IR Wi-Fi	155	209	28	100/125	28

Designation key				
Smart	IR	Wi-Fi	Savanna	
Model	Motion sensor	Integrated Wi-Fi module	Colour	

Technical data

Model	Smart Wi-Fi / Smart IR Wi-Fi					
	Smart Wi-Fi		Smart IR Wi-Fi			
Duct diameter [mm]	100			125		
Mode	24 hours	Silent	Max	24 hours	Silent	Max
Voltage [V]	100-240					
Frequency [Hz]	50/60					
Power [W]	1.6	2.9	5.6	1.7	3	6
Current [A]	0.02	0.04	0.06	0.03	0.04	0.07
Air flow [m³/h (l/s)]	33 (9)	72 (20)	106 (29)	40 (11)	83 (23)	133 (37)
Control range [m³/h (l/s)]	–	33 ... 106 (9 ... 29)		–	40 ... 133 (11 ... 37)	
Sound pressure level [dBA]*	17	21	31	17	22	32

* Sound pressure level measured in free space at a distance of 3 meters from the fan.

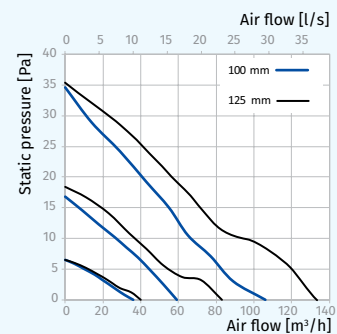

Accessories

Duct system	Flexible air ducts	Grilles and hoods	Clamps
BlauPlast	BlauFlex	Decor, GM	K, KZ

CABRIO BASE

SILENT & ENERGY SAVING

Innovative domestic exhaust fan with an automatic shutter, low noise operation and low energy consumption



Air flow:
97 m³/h
27 l/s



Power:
9 W

SFP:
0.33 W/l/s



Noise level:
25 dBA



Features



- Low energy demand not exceeding 9 W due to a new energy efficient motor.
- The casing and the impeller are made of high-quality, durable, UV resistant ABS plastic.
- Specially designed impeller aerodynamic profile provides high air flow and low noise operation.
- The motor is mounted on special anti-vibration dampers for absorption of vibration and low noise operation. The motor is equipped with over-heating protection.
- Maintenance-free bearings contain enough grease for 40 000 hrs of non-stop operation of the motor.
- The fan is equipped with a special mechanism for smooth opening and closing of the front panel.

- The fan exhaust spigot incorporates specially designed air rectifiers to reduce air turbulence and noise level.
- The fan is controlled manually with a room light switch (not included in the delivery set).
- Due to the high ingress protection rating IP44 the fan is an ideal bathroom ventilation solution. The electronic components are protected with tight covers.
- The shortened spigot enables to install the fan in a ventilation shaft or to connect to a Ø 100 mm air duct.
- The ventilation unit is easily removed from the casing for cleaning.
- Due to the modern design the fan can seamlessly blend with any interior design.

Application example



CABRIO BASE

SILENT & ENERGY SAVING

Options



Model	Cabrio Base 100	
Option	T	H
Timer	•	•
Humidity sensor		•

o Timer

- Adjustable delay from 2 to 30 min.
- Turn-on delay time set for 60 sec.
- Interval timer set for 0, 6, 12 or 24 h.

o Humidity sensor

- Humidity setpoint adjustable from 60 % up to 90 %.

Overall dimensions

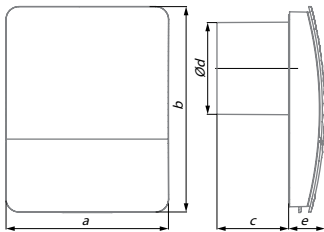

Dimensions [mm]	a	b	c	Ø d	e
Cabrio Base 100	175	221	77	99	39

Designation key		
Cabrio Base	100	T
Model	Spigot diameter	Option

Technical data

Model	Cabrio Base 100	Cabrio Base 100 (220-240V/60Hz)
Voltage [V]	220-240	
Frequency [Hz]	50	60
Power [W]	9	
Current [A]	0.059	
RPM [min ⁻¹]	2160	
Air flow [m ³ /h (l/s)]	97 (27)	
SFP [W/l/s]	0.33	
Sound pressure level [dBA]*	25	
Weight [kg]	0.55	

* Sound pressure level measured in free space at a distance of 3 meters from the fan.

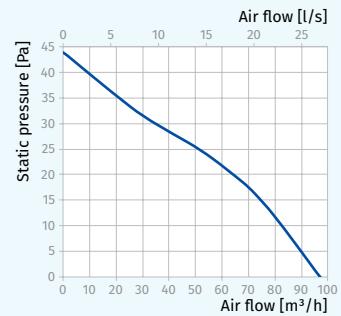

Accessories

Duct system	Flexible air ducts	Grilles and hoods	Speed controllers	Clamps
BlauPlast	BlauFlex	Decor, GM	SGS E1	CDT E1.8, MCD 60/0.3, K, KZ

CABRIO BASE V2

SILENT & ENERGY SAVING

Innovative two-speed domestic exhaust fan with an automatic shutter, low noise operation and low energy consumption



Air flow:
up to 90 m³/h
25 l/s



Power:
from 6 W

SFP:
from 0.34 W/l/s



Noise level:
from 22 dBA



Features



- Low energy demand from 6 W due to a new energy efficient two-speed motor.
- The casing and the impeller are made of high-quality, durable, UV resistant ABS plastic.
- Specially designed profile of the mixed-flow impeller provides high air flow and low noise operation.
- The motor is mounted on special anti-vibration dampers for absorption of vibration. The motor is equipped with overheating protection.
- Maintenance-free bearings contain enough grease for 40 000 hrs of non-stop operation of the motor.
- The fan is equipped with a special mechanism for smooth opening and closing of the front panel.
- The fan exhaust spigot incorporates specially designed air rectifiers to reduce air turbulence and noise level.
- Due to the high ingress protection rating IP44 the fan is an ideal bathroom ventilation solution. The electronic components are protected with tight covers.
- The ventilation unit is easily removed from the casing for cleaning.
- The shortened spigot enables to install the fan in a ventilation shaft or to connect to a Ø 100 mm air duct.

Control

- Manual control with a room light switch. The switch is not included into the delivery set.
- Automatic control is performed with the humidity sensor or/and the timer.
- Selection of the operation mode is performed via changeover of the switch as follows:
 - **Operation mode 1:** the fan is turned off by default. The fan switches to the low speed when the switch is closed or to the high speed when the humidity sensor is activated;
 - **Operation mode 2:** the fan is turned off by default. The fan switches to the high speed when the switch is closed or the humidity sensor is activated.

Application example



CABRIO BASE V2

SILENT & ENERGY SAVING

Options



Model	Cabrio Base V2 100	
	T	H
Interval timer	•	
Turn-on delay timer	•	•
Turn-off delay timer	•	•
Humidity sensor		•

- Interval timer**
 - If the interval timer is enabled, the fan will turn on automatically each 6, 12 of 24 hrs, and it will operate from 2 to 30 min, depending of turn-off delay timer setting.
- Turn-on delay timer**
 - Fixed turn-on delay time of 60 sec.
- Turn-off delay timer**
 - Adjustable delay from 2 to 30 min.
- Humidity sensor**
 - Humidity setpoint adjustable from 60 % up to 90 %.

Overall dimensions

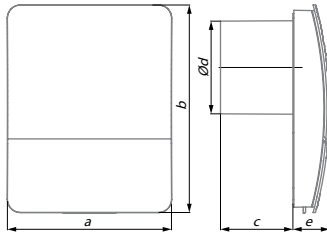

Dimensions [mm]	a	b	c	Ø d	e
Cabrio Base V2 100	175	221	77	99	39

Technical data

Model	Cabrio Base V2 100	
	min	max
Speed		
Voltage [V/Hz]	220-240/50	
Power [W]	6	8.5
Current [A]	0.039	0.063
RPM [min ⁻¹]	1850	2400
Air flow [m ³ /h (l/s)]	60 (17)	90 (25)
SFP [W/l/s]	0.36	0.34
Sound pressure level [dBA]*	22	25
Weight [kg]	0.55	

* Sound pressure level measured in free space at a distance of 3 meters from the fan.

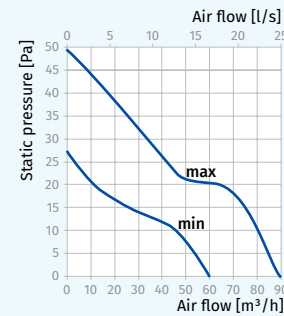

Designation key

Cabrio Base	V2	100	T
Model	Two-speed motor	Spigot diameter	Option

Accessories				
Duct system	Flexible air ducts	Grilles and hoods	Speed controllers	Clamps
BlauPlast	BlauFlex	Decor, GM	CDP-2/5 CDP-2/10	MCD 60/0.3 K, KZ

SILEO / SILEO MAX

SILENT & ENERGY SAVING

Features



- Specially designed mixed-flow impeller profile ensures high air flow and low noise level.
- Casing and impeller made of quality durable UV-resistant plastic.
- Backdraft damper for back flow prevention.
- The high ingress protection rating of IP45 makes the fan the ideal solution for the ventilation of bathrooms and shower rooms.
- Low energy demand from 7.5 W due to a new high-efficient motor.
- The motor is mounted on special anti-vibration dampers.
- The exhaust pipe incorporates a specially designed air rectifier to reduce the air turbulence, increase pressure and lower the noise level.
- The **Sileo 150** fan is equipped with a double-speed motor and the **Sileo Max 150** fan is equipped with a double-speed high-powered motor.
- The new automation in the **Sileo 150** and **Sileo Max 150** models enables setting one of five fan operation modes. Changeover to another operation mode is easily performed by setting the DIP switch to a respective position.



Air flow:
up to 370 m³/h
103 l/s



Power:
from 7.5 W
SFP:
from 0.21 W/l/s



Noise level:
from 25 dBA



Options



Model	Sileo 100/125 / Sileo (Max) 150						
	S	T	TR	ST	H	SH	IR
Pull cord switch	•			•		•	
Turn-on delay timer			•				
Turn-off delay timer		•	•	•		•	•
Humidity sensor					•	•	
Motion sensor							•

Turn-on delay timer

- Turn-on delay time adjustable from 0 to 2 min.

Turn-off delay timer

- Adjustable delay from 2 to 30 min.

Humidity sensor

- Humidity setpoint adjustable from 60 % up to 90 %.

Motion sensor

- Detection range from 1 up to 4 m.
- Detection angle up to 100°.

* For Sileo 150/Sileo Max 150 models – turn-on and turn-off delay timer

Overall dimensions

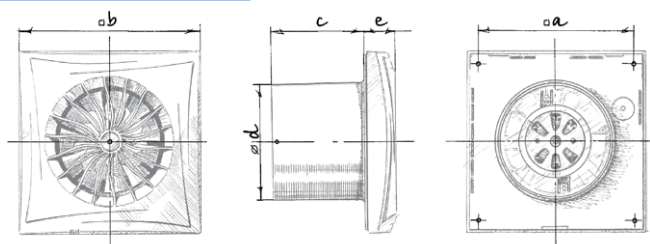

Dimensions [mm]	a	b	c	Ø d	e
Sileo 100	136	158	81	100	26
Sileo 125	158	182	91	124	27
Sileo 150	190	214	98	148	32

Technical data

Model	Sileo 100	Sileo 125	Sileo 150		Sileo Max 150	
			min	max	min	max
Speed						
Voltage [V/Hz]	220-240/50	220-240/50	220-240/50		220-240/50	
Power [W]	7.5	17	17	19	19	22
Current [A]	0.049	0.11	0.08	0.09	0.09	0.1
Air flow [m ³ /h (l/s)]	97 (27)	187 (52)	220 (61)	315 (88)	280 (78)	370 (103)
SFP [W/l/s]	0.28	0.33	0.27	0.22	0.24	0.21
Sound pressure level [dBA]*	25	32	28	33	32	38

* Sound pressure level measured in free space at a distance of 3 meters from the fan.

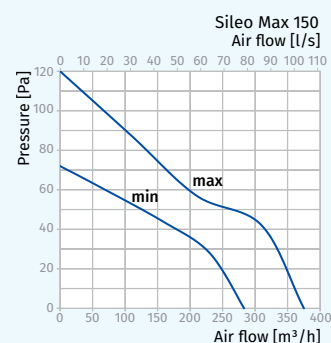
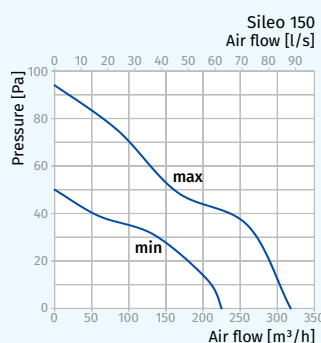
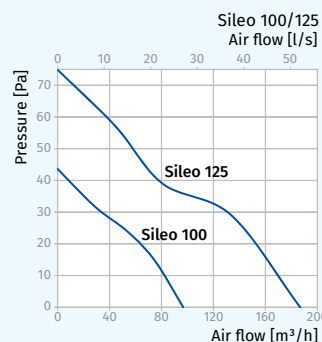

Designation key

Sileo	Max	150	ST
Model	High-powered motor	Spigot diameter	Option

Accessories

Duct system



BlauPlast

Flexible air ducts



BlauFlex

Grilles and hoods



Decor, GM

Speed controllers



CDT E1.8

MCD 60/0.3

Clamps



K, KZ

SILEO V2

SILENT & ENERGY SAVING

Features



- The specially designed mixed-flow impeller profile ensures high air flow and low noise level.
- The casing and the impeller are made of quality durable UV-resistant plastic.
- The fan is equipped with a backdraft damper for back flow prevention.
- The high ingress protection rating of IP45 makes the fan the ideal solution for the ventilation of bathrooms and shower rooms.
- The motor is mounted on special anti-vibration dampers.
- The exhaust pipe incorporates a specially designed air rectifier to reduce the air turbulence, increase pressure and lower the noise level.
- Ideal for intermittent or continuous ventilation.



Air flow:
up to 170 m³/h
47 l/s



Power:
from 4.5 W
SFP:
from 0.24 W/l/s



Noise level:
from 22 dBA



Options



Model	Sileo V2 100/125		
Option	S	T	H
Pull cord switch	•		
Interval timer		•	
Turn-on delay timer		•	•
Turn-off delay timer		•	•
Humidity sensor			•

- **Turn-on delay timer**
 - Fixed turn-on delay time of 60 sec.
- **Turn-off delay timer**
 - Adjustable delay from 2 to 30 min.
- **Interval timer**
 - If the interval timer is enabled, the fan will turn on automatically each 6, 12 or 24 hours and it will operate from 2 to 30 min, depending on the turn-off delay timer setting.
- **Humidity sensor**
 - Humidity setpoint adjustable from 60 % up to 90 %.

Overall dimensions

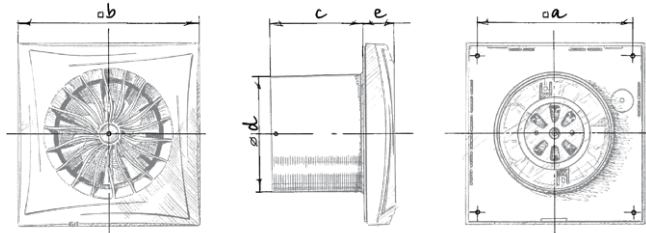

Dimensions [mm]	a	b	c	Ø d	e
Sileo V2 100	136	158	81	100	26
Sileo V2 125	168	182	91	124	27

Designation key			
Sileo	V2	125	H
Model	Two-speed motor	Spigot diameter	Option

Technical data

Model	Sileo V2 100		Sileo V2 125	
	min	max	min	max
Speed				
Voltage [V/Hz]	220-240/50(60)			
Power [W]	4.5	7	9.5	13.5
Current [A]	0.029	0.052	0.065	0.09
RPM [min ⁻¹]	1850	2400	1800	2250
Air flow [m ³ /h (l/s)]	60 (17)	90 (25)	145 (40)	170 (47)
SFP [W/l/s]	0.27	0.28	0.24	0.29
Sound pressure level [dBA]*	22	25	28	32

* Sound pressure level measured in free space at a distance of 3 meters from the fan.

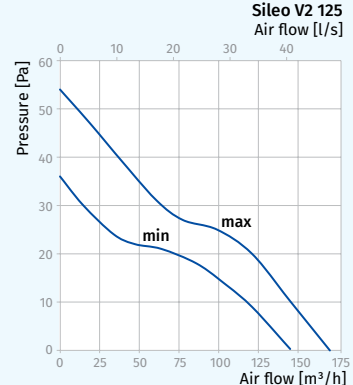
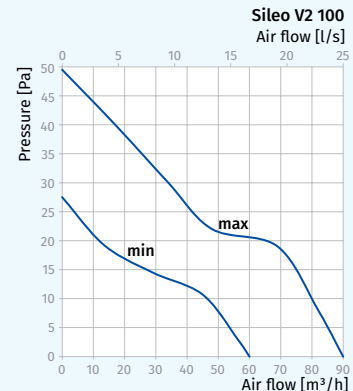

Accessories

Duct system

Flexible air ducts

Grilles and hoods

Speed controllers

Clamps



BlauPlast



BlauFlex



Decor, GM



CDP-2/10



K, KZ

SILEO DC

SILENT & ENERGY SAVING

High performance low noise exhaust fans with energy efficient DC motors



Air flow:
up to 101 m³/h
28 l/s



Power:
from 1.5 W

SFP:
from 0.08 W/l/s



Noise level:
from 22 dBA



Features



- The casing and the impeller are made of high-quality and durable UV-resistant plastic.
- The specially designed aerodynamic profile of the mixed-flow impeller provides high air flow and pressure combined with low noise operation.
- A shortened spigot for mounting into a ventilation shaft or direct connection to a Ø 100 mm air duct.
- The fan is equipped with a specially designed backdraft damper to prevent back flow and heat losses during the fan standby.
- The fan exhaust spigot incorporates specially designed air rectifiers to reduce air turbulence, noise level and boost air pressure.
- High ingress protection rating makes the fan the ideal solution for ventilation of a bathroom.
- The electronic components are protected with tight covers.

Options



Model	Sileo DC 100		
	T	H	IR
Turn-off delay timer	•	•	•
Humidity sensor		•	
Motion sensor			•

- **Turn-off delay timer**
 - Adjustable delay from 2 up to 30 min.
- **Humidity sensor**
 - Humidity setpoint adjustable from 60 % up to 90 %.
- **Motion sensor**
 - Detection range from 1 up to 4 m.
 - Detection angle up to 100°.

Operation mode

Operation mode selection and setup for Sileo DC 100 models with modifications T, H, IR is performed by setting the DIP switch to a respective position.

MODE 1 (SINGLE-SPEED MODE)

- The fan is turned off by default. The fan starts operating at the low speed when the switch is closed or one of the sensors is activated.

MODE 2 (SINGLE-SPEED MODE)

- The fan is turned off by default. The fan starts operating at the high speed when the switch is closed or one of the sensors is activated.

MODE 3 (TWO-SPEED MODE)

- The fan operates at the low speed by default. The fan switches to the high speed when the switch is closed or the sensors are activated.

MODE 4 (TWO-SPEED MODE)

- The fan is turned off by default. The fan starts operating at the low speed when the switch is closed and switches to the high speed when the humidity or motion sensor is activated.

Motor

- Low energy demand up to 3.5 W due to a new high-efficient DC motor.
- Maintenance-free bearings contain enough grease for 40 000 hrs of non-stop operation.
- The motor is equipped with electric overheating protection.

Accessories

Duct system	Flexible air ducts	Grilles and hoods	Clamps
BlauPlast	BlauFlex	Decor, GM	K, KZ

SILEO DC

SILENT & ENERGY SAVING

Overall and mounting dimensions

- o Direct installation into a ventilation shaft.
- o Flexible air ducts may be used in case of remote location of the ventilation shaft. The air duct is connected to the exhaust spigot with a fixing clamp.
- o Wall mounting with screws.
- o Suitable for ceiling mounting.

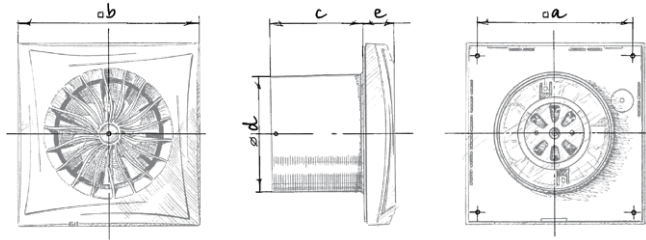

Dimensions [mm]	a	b	c	Ø d	e
Sileo DC 100	136	158	81	100	26

Technical data

Model	Sileo DC 100	
	min	max
Voltage [V/Hz]	220-240/50(60)	
Power [W]	1.5	3.5
Current [A]	0.063	0.137
RPM [min ⁻¹]	1850	2650
Air flow [m ³ /h (l/s)]	70 (19)	101 (28)
SFP [W/l/s]	0.08	0.12
Sound pressure level [dBA]*	22	27

* Sound pressure level measured in free space at a distance of 3 meters from the fan.

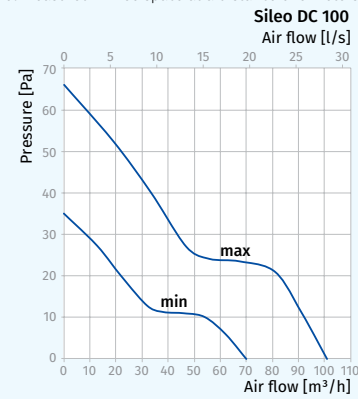

Designation key

Sileo	DC	100	T
Model	Direct current motor	Spigot diameter	Option

SILEO DESIGN

SILENT & ENERGY SAVING

Features



- The specially designed mixed-flow impeller profile ensures high air flow and low noise level.
- The casing and the impeller are made of quality durable UV-resistant plastic.
- The fan is equipped with a backdraft damper for back flow prevention.
- The high ingress protection rating of IP45 makes the fan the ideal solution for the ventilation of bathrooms and shower rooms.
- Low energy demand from 7.5 W due to a new high-efficient motor.
- The motor is mounted on special anti-vibration dampers.
- The exhaust pipe incorporates a specially designed air rectifier to reduce the air turbulence, increase pressure and lower the noise level.



Air flow:
90 m³/h
25 l/s



Power:
7.5 W

SFP:
0.30 W/l/s



Noise level:
26 dBA



Options



Model	Sileo Design 100					
Option	S	T	TR	ST	H	SH
Pull cord switch	•			•		•
Turn-on delay timer			•			
Turn-off delay timer		•	•	•	•	•
Humidity sensor					•	•

- **Turn-on delay timer**
 - Turn-on delay time adjustable from 0 to 2 min.
- **Turn-off delay timer**
 - Adjustable delay from 2 to 30 min.
- **Humidity sensor**
 - Humidity setpoint adjustable from 60 % up to 90 %.

Overall dimensions and mounting

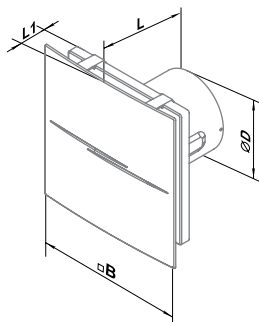

Dimensions [mm]	Ø D	B	L	L1
Sileo Design 100	99	200	130	49

- Installation directly inside a ventilation shaft.
- Flexible air ducts may be used in case of remote location of the ventilation shaft. Connection of the air duct to the exhaust spigot with a clamp.
- Wall mounting with screws.
- Suitable for ceiling mounting.

Technical data

Model	Sileo Design 100
Voltage [V/Hz]	220-240/50(60)
Power [W]	7.5
Current [A]	0.050
RPM [min ⁻¹]	2165
Air flow [m ³ /h (l/s)]	90 (25)
SFP [W/l/s]	0.30
Sound pressure level [dBA]*	26

* Sound pressure level measured in free space at a distance of 3 meters from the fan.

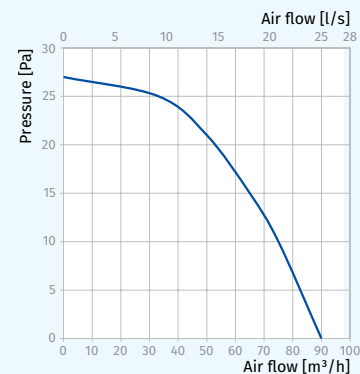

Designation key

Sileo Design	100	H
Model	Spigot diameter	Option

Accessories

Duct system



BlauPlast

Flexible air ducts



BlauFlex

Grilles and hoods



Decor, GM

Speed controllers



MCD 60/0.3

Clamps



K, KZ

SILEO DESIGN V2

SILENT & ENERGY SAVING

Features



- o Double-speed fan with air flow up to 90 m³/h.
- o The specially designed mixed-flow impeller profile ensures high air flow and low noise level.
- o The casing and the impeller are made of quality durable UV-resistant plastic.
- o The fan is equipped with a backdraft damper for back flow prevention.
- o The high ingress protection rating of IP45 makes the fan the ideal solution for the ventilation of bathrooms and shower rooms.
- o The motor is mounted on special anti-vibration dampers.
- o The exhaust pipe incorporates a specially designed air rectifier to reduce the air turbulence, increase pressure and lower the noise level.
- o Ideal for intermittent or continuous ventilation.



Air flow:
up to 90 m³/h
25 l/s



Power:
from 4.5 W
SFP:
from 0.27 W/l/s



Noise level:
from 22 dBA



Options



Model	Sileo Design V2 100		
	S	T	H
Pull cord switch	•		
Interval timer		•	
Turn-on delay timer		•	•
Turn-off delay timer		•	•
Humidity sensor			•

- o **Turn-on delay timer**
 - Fixed turn-on delay time of 60 sec.
- o **Turn-off delay timer**
 - Adjustable delay from 2 to 30 min.
- o **Interval timer**
 - If the interval timer is enabled, the fan will turn on automatically each 6, 12 or 24 hrs, and it will operate from 2 to 30 min, depending on the turn-off delay timer setting.
- o **Humidity sensor**
 - Humidity setpoint adjustable from 60 % up to 90 %.

Technical data

Model	Sileo Design V2 100	
	min	max
Voltage [V/Hz]	220-240/50	
Power [W]	4.5	7
Current [A]	0.029	0.052
RPM [min ⁻¹]	1850	2400
Air flow [m ³ /h (l/s)]	60 (17)	90 (25)
SFP [W/l/s]	0.27	0.28
Sound pressure level [dBA]*	22	25

* Sound pressure level measured in free space at a distance of 3 meters from the fan.

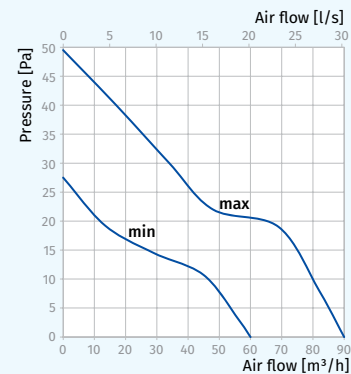

Designation key

Sileo Design	V2	100	H
Model	Two-speed motor	Spigot diameter	Option

Overall dimensions

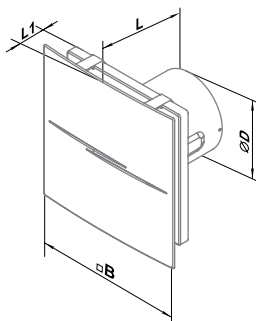

Dimensions [mm]	Ø D	B	L	L1
Sileo Design V2 100	99	200	130	49

Accessories

Duct system



BlauPlast

Flexible air ducts



BlauFlex

Grilles and hoods



Decor, GM

Speed controllers



CDP-2/10

Clamps



K, KZ

TRIO

SILENT & ENERGY SAVING

Low noise and low power exhaust axial fan with air flow up to 255 m³/h



Air flow:
up to 255 m³/h
71 l/s



Power:
from 8 W
SFP:
from 0.32 W/l/s



Noise level:
from 29 dBA



Features



- Wall and ceiling mounting.
- The casing, impeller and the front panel are made of high-quality and UV-resistant ABS plastic.
- The aerodynamic design of the impeller ensures high air flow and low noise level.
- The fan outlet pipe incorporates specially designed air rectifiers to reduce air turbulence, noise level and increase air pressure.
- The fan is equipped with a specially designed backdraft damper to prevent back flow and heat losses during the fan standby.
- Ventilation shaft mounting or connection to Ø 100 mm and Ø 150 mm air ducts.
- Maintenance-free bearings contain enough grease for 40 000 hrs of non-stop operation.

Options



Model	Trio 100 / Trio 150					
Option	S	T	TR	ST	H	SH
Pull cord switch	•			•		•
Turn-on delay timer			•			
Turn-off delay timer		•	•	•	•	•
Humidity sensor					•	•

- **Turn-on delay timer**
 - Adjustable delay from 10 seconds to 2 minutes.
- **Turn-off delay timer**
 - Adjustable delay from 2 to 30 minutes.
- **Humidity sensor**
 - Humidity sensor activation threshold is adjustable from 60 % to 90 %.

Overall dimensions and mounting

- The fan is installed directly into the ventilation shaft.
- Flexible duct connection is recommended in case of the remote ventilation shaft location. The air duct is connected to the fan exhaust spigot through a clamp.
- Fixation to the wall or ceiling with screws.

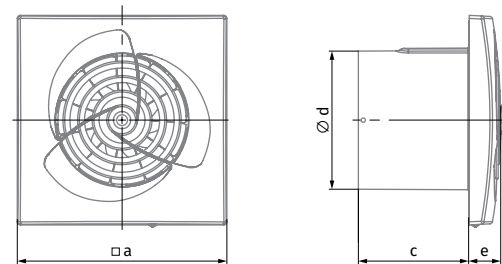

Dimensions [mm]	a	c	Ø d	e
Trio 100	150	79	99	23
Trio 150	206	100	148	23

Designation key		
Trio	100	H
Model	Spigot diameter	Option

Accessories

Duct system	Flexible air ducts	Grilles and hoods	Speed controllers	Clamps
BlauPlast	BlauFlex	Decor, GM	SGS E1 MCD 60/0.3	K, KZ

TRIO

SILENT & ENERGY SAVING

Technical data

Model	Trio 100	Trio 150
Voltage [V/Hz]	220-240/50	220-240/50
Power [W]	8	28
Current [A]	0.05	0.21
Air flow [m ³ /h (l/s)]	90 (25)	255 (71)
SFP [W/l/s]	0.32	0.39
Sound pressure level [dBA]*	29	35
Weight [kg]	0.45	0.97

* Sound pressure level measured in free space at a distance of 3 meters from the fan.

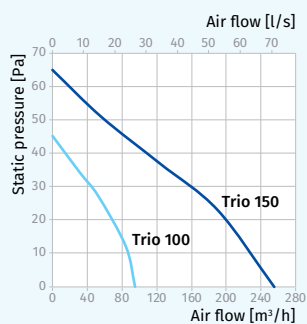

CE GS IP44

Application example



TRIO V2

SILENT & ENERGY SAVING

Low noise and low power two-speed exhaust axial fan with air flow up to 300 m³/h



Air flow:
up to 300 m³/h
83 l/s



Power:
from 5 W
SFP:
from 0.25 W/l/s



Noise level:
from 23 dBA



Features



- 2 speed modes: I – for the permanent ventilation, II (by a sensor or switch) – for the intermittent ventilation.
- Wall and ceiling mounting.
- The casing, impeller and the front panel are made of high-quality and UV-resistant ABS plastic.
- The aerodynamic design of the impeller ensures high air flow and low noise level.
- The fan outlet pipe incorporates specially designed air rectifiers to reduce air turbulence, noise level and increase air pressure.
- The fan is equipped with a specially designed backdraft damper to prevent back flow and heat losses during the fan standby.
- Ventilation shaft mounting or connection to Ø 100 mm and Ø 150 mm air ducts.
- Maintenance-free bearings contain enough grease for 40 000 hrs of non-stop operation.

Options



Model	Trio V2 100 / Trio V2 150	
Option	TR	H
Turn-on delay timer	•	•
Turn-off delay timer	•	•
Humidity sensor		•

TR OPTION

- **Turn-on delay timer**
 - Adjustable delay from 10 seconds to 2 minutes.
- **Turn-off delay timer**
 - Adjustable delay from 2 to 30 minutes.

H OPTION

- **Turn-on delay timer**
 - A non-adjustable turn-on delay timer of 45 s, when the switch is closed; turn-on delay is not available when the humidity sensor is activated.
- **Turn-off delay timer**
 - An adjustable turn-off delay from 2 to 30 min after the switch is opened. If the humidity sensor is activated, the turn-off delay time is fixed (5 min).
- **Humidity sensor**
 - Humidity sensor activation threshold is adjustable from 60 % to 90 %.

Overall dimensions and mounting

- The fan is installed directly into the ventilation shaft.
- Flexible duct connection is recommended in case of the remote ventilation shaft location. The air duct is connected to the fan exhaust spigot through a clamp.
- Fixation to the wall or ceiling with screws.

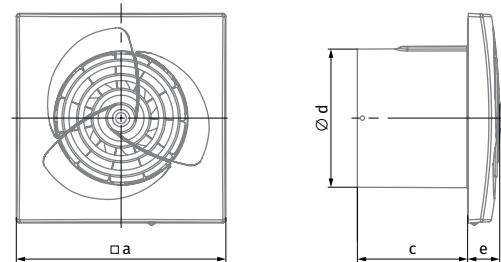

Dimensions [mm]	a	c	Ø d	e
Trio V2 100	150	79	99	23
Trio V2 150	206	100	148	23

Designation key			
Trio	V2	100	H
Model	Two-speed motor	Spigot diameter	Option

Accessories

Duct system



BlauPlast

Flexible air ducts



BlauFlex

Grilles and hoods



Decor, GM

Clamps



K, KZ

TRIO V2

SILENT & ENERGY SAVING

Technical data

Model	Trio V2 100		Trio V2 150	
	min	max	min	max
Speed				
Voltage [V/Hz]	220-240/50		220-240/50	
Power [W]	5	8	18	21
Current [A]	0.03	0.05	0.079	0.085
Air flow [m³/h (l/s)]	54 (15)	81 (23)	210 (58)	300 (83)
SFP [W/l/s]	0.33	0.36	0.31	0.25
Sound pressure level [dBA]*	23	28	29	35
Weight [kg]	0.55		0.97	

* Sound pressure level measured in free space at a distance of 3 meters from the fan.

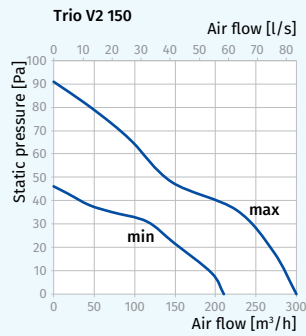
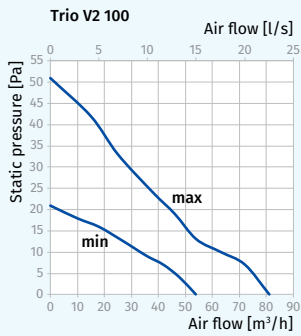

CE GS IP44

Application example



AERO STILL

SILENT & ENERGY SAVING

Features



- Wall and ceiling mounting
- Low energy consumption and noise level
- Easy maintenance
- Continuous operation
- Backdraft damper
- Ball bearing motor
- Available in Vintage plastic and with decorative chrome finish (Aero Still Chrome)
- 5 year warranty



Air flow:
up to 254 m³/h
71 l/s



Power:
from 5.5 W

SFP:
from 0.21 W/l/s



Noise level:
from 25 dBA



Chrome



Vintage

Options



Model	Aero Still 100/125/150				
	S	T	ST	H	SH
Pull cord switch	•		•		•
Timer		•	•	•	•
Humidity sensor				•	•

- Turn-off delay adjustable from 2 to 30 min.
- Humidity setpoint adjustable from 60 % up to 90 %.

Overall dimensions and mounting

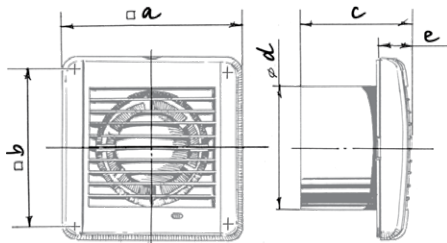

Dimensions [mm]	a	b	c	∅ d	e
Aero Still 100	144	122	92.5	100	29.5
Aero Still 125	168	144	97	125	30
Aero Still 150	198	170	119	150	30

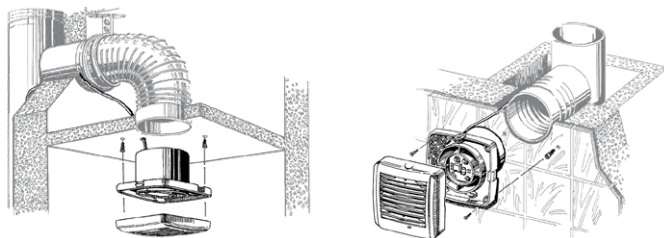

Technical data

Model	Aero Still 100	Aero Still 125	Aero Still 150
Voltage [V/Hz]	220-240/50	220-240/50	220-240/50
Power [W]	5.5	9.4	19
Current [A]	0.035	0.059	0.14
Air flow [m ³ /h (l/s)]	84 (23)	158 (44)	254 (71)
SFP [W/l/s]	0.24	0.21	0.27
Sound pressure level [dBA]*	25	31	33

* Sound pressure level measured in free space at a distance of 3 meters from the fan.

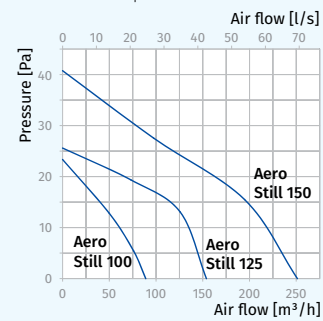

Designation key

Aero	Still	Chrome	125	SH
Model	Silent	Colour	Spigot diameter	Option

Accessories

Duct system	Flexible air ducts	Grilles and hoods	Speed controllers	Clamps
BlauPlast	BlauFlex	Decor, GM	CDT E1.8 MCD 60/0.3	K, KZ

BRAVO STILL

SILENT & ENERGY SAVING

Features



- o Wall and ceiling mounting
- o Easy maintenance
- o Continuous operation
- o Backdraft damper
- o Ball bearing motor
- o Available in chrome (Bravo Still Chrome) and platinum (Bravo Still Platinum) finish
- o 5 year warranty



Air flow:
up to 235 m³/h
65 l/s



Power:
from 5.6 W
SFP:
from 0.29 W/l/s



Noise level:
from 26 dBA



Chrome



Platinum

Options



Model	Bravo Still 100/125/150					
	S	T	ST	H	SH	IR
Pull cord switch	•		•		•	
Timer		•	•	•	•	•
Humidity sensor				•	•	
Motion sensor						•

o Timer

- Turn-off delay adjustable from 2 to 30 min.

o Humidity sensor

- Humidity setpoint adjustable from 60 % up to 90 %.

o Motion sensor

- Detection range from 1 up to 4 m.
- Detection angle up to 100°.

Overall dimensions and mounting

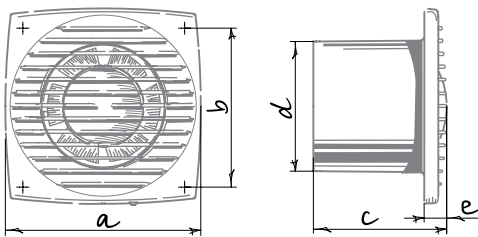

Dimensions [mm]	a	b	c	∅ d	e
Bravo Still 100	150	122	102	100	17
Bravo Still 125	176	144	104	125	17
Bravo Still 150	205	174	124	150	19



Technical data

Model	Bravo Still 100	Bravo Still 125	Bravo Still 150
Voltage [V/Hz]	220-240/50	220-240/50	220-240/50
Power [W]	5.6	9.3	20
Current [A]	0.04	0.006	0.13
Air flow [m ³ /h (l/s)]	70 (19)	115 (32)	235 (65)
SFP [W/l/s]	0.29	0.29	0.31
Sound pressure level [dBA]*	26	31	35

* Sound pressure level measured in free space at a distance of 3 meters from the fan.

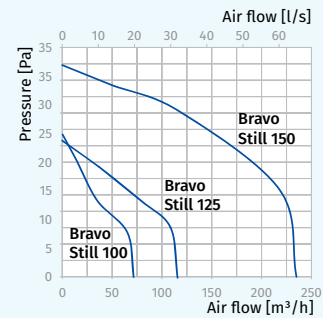

Designation key

Bravo	Still	Chrome	100	S
Model	Low noise application	Colour	Spigot diameter	Option

Accessories

Duct system



BlauPlast

Flexible air ducts



BlauFlex

Grilles and hoods



Decor, GM

Speed controllers



CDT E1.8

MCD 60/0.3

Clamps



K, KZ

DESIGN KONZEPT SYSTEM

Features

- New ventilation design solution: **Blauberg Design Konzept**.
- It includes **Omega** fans, a **Decor FB 140x140 s** grille, a **DPK 100** diffuser and a range of interchangeable stylish design decorative panels.
- You decide yourself what your fan and interior design will look like
- Panels can be changed if you prefer
- The entire ventilation system in the house can be designed in the same style.

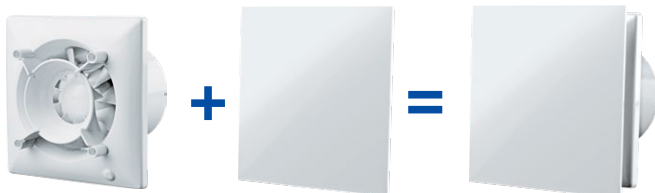

design



kollzept

Bases



BLAUBERG OMEGA
Quiet and energy efficient



BLAUBERG DPK 100
Diffuser



BLAUBERG DECOR FB 140X140 S
Grille

Panels



DECORATIVE PANELS OF ABS PLASTIC



DECORATIVE PANELS WITH METAL FINISH



DECORATIVE GLASS PANELS



OMEGA

DESIGN KONZEPT SYSTEM

Features

- One of the quietest and most economical fans on the market due to its mixed-flow impeller, special streamer and modern electric motor.
- No drafts due to a built-in back valve.
- 40 000 hours of continuous operation.
- Both wall and ceiling mounting are possible.
- Compatible with all decorative panels of the **Design Konzept** system.



Air flow:
up to 160 m³/h
44 l/s



Power:
from 8 W
SFP:
from 0.18 W/l/s



Noise level:
from 29 dBA



Options

Model	Omega 100 / Omega 100 (220-240V/60Hz) / Omega 125 / Omega 125 (220V/60Hz)			
	S	T	TR	H
Pull cord switch	•			
Turn-on delay timer			•	
Turn-off delay timer		•	•	•
Humidity sensor				•

- Turn-on delay timer**
 - Adjustable delay from 10 seconds to 2 minutes.
- Turn-off delay timer**
 - Adjustable delay from 2 to 30 minutes.
- Humidity sensor**
 - Humidity sensor activation threshold is adjustable from 60 % to 90 %.

Overall dimensions and mounting

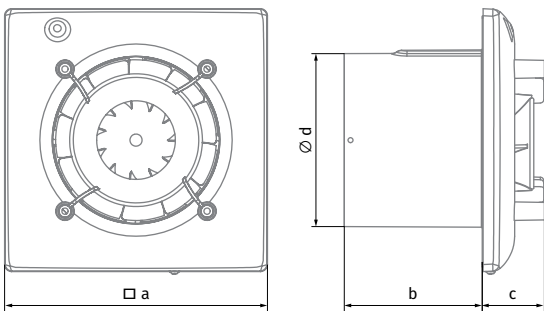

Dimensions [mm]	a	∅ d	b	c
Omega 100	150	99	79	36
Omega 125	180	124	85	36

Designation key			
Omega	100	220-240V/60Hz	H
Model	Spigot ∅	Voltage/Frequency	Option

Technical data

Model	Omega 100	Omega 100 (220-240V/60Hz)	Omega 125	Omega 125 (220-240V/60Hz)
Voltage [V]	220-240	220-240	220-240	220-240
Frequency [Hz]	50	60	50	60
Power [W]	8	8	17	17
Current [A]	0.05	0.05	0.11	0.11
RPM [min ⁻¹]	2165	2165	2200	2200
Air flow [m ³ /h] (l/s)	90 (25)	90 (25)	160 (44)	160 (44)
SFP [W/l/s]	0.32	0.32	0.41	0.41
Sound pressure level [dBA]*	29	29	32	32

* Sound pressure level measured in free space at a distance of 3 meters from the fan.

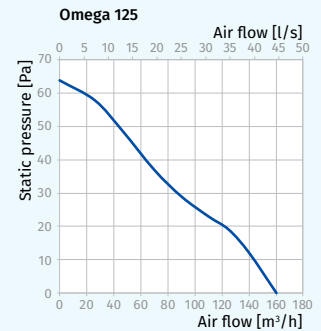
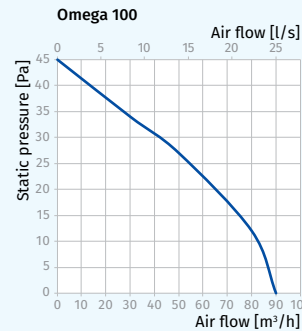

DECOR FB 140x140 s

DESIGN KONZEPT SYSTEM

Features

- Wall or ceiling mounting.
- Reinforced structure.
- Equipped with an insect screen for protection against insects and foreign objects.
- Compatible with plastic and metal decorative panels of the **Design Konzept** system.

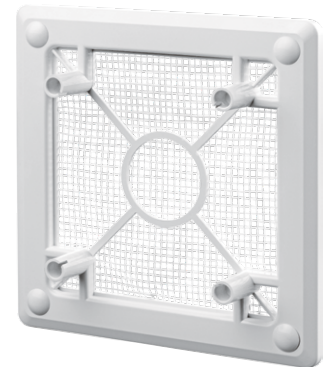

Overall dimensions [mm]

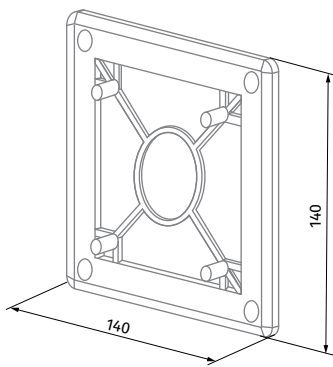

Technical data

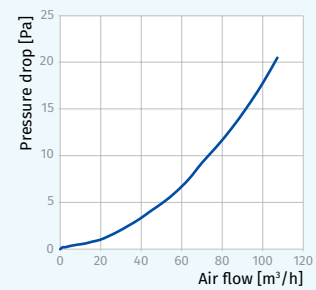

DPK 100

Features

- Designed for wall mounting or installation into false ceilings.
- Special aerodynamic shape ensures uniform air distribution.
- Easy mounting with a mounting flange and screws.
- External removable grille for maintenance and cleaning.
- Compatible with all decorative panels of the **Design Konzept** system.



Overall dimensions [mm]

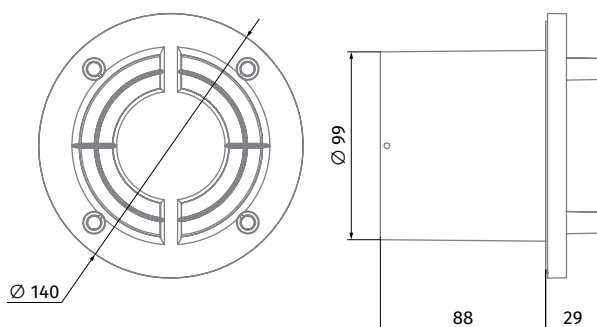

Technical data

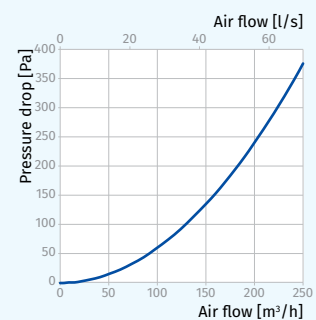

DECORATIVE PANELS

DESIGN KONZEPT SYSTEM

Design Konzept System panels are the finishing touch of your home's ventilation design

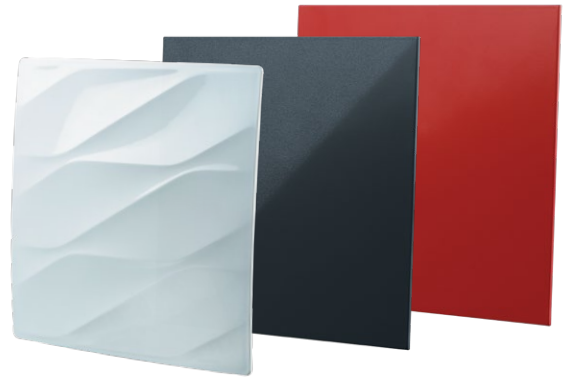

Decorative panels of ABS plastic

- Made of high quality UV resistant ABS plastic.
- All panels are compatible with Ø 100 mm and Ø 125 mm fans.

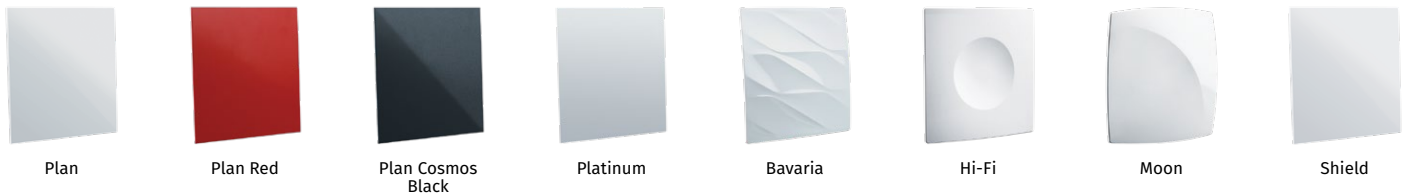

GENERAL COMPATIBILITY CHART

	DP 180 Plan	DP 180 Plan Red	DP 180 Plan Cosmos Black	DP 180 Platinum	DP 180 Bavaria	DP 180 Hi-Fi	DP 180 Moon	DP 180 Shield
Omega 100	•	•	•	•	•	•	•	•
Omega 125	•	•	•	•	•	•	•	•
Decor FB 140x140 s	•	•	•	•	•	•	•	•
DPK 100	•	•	•	•	•	•	•	•

Decorative panels with metal finish

- Various visual effects of metal surfaces.
- Compatible with Ø 100 mm and Ø 125 mm fans.

GENERAL COMPATIBILITY CHART

	DP 180 Chrome	DP 180 Hi-Tech
Omega 100	•	•
Omega 125	•	•
Decor FB 140x140 s	•	•
DPK 100	•	•

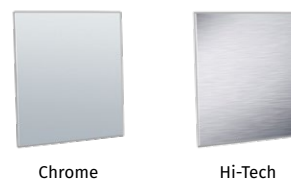

Decorative panels of natural glass

- Environmental friendliness, practicality and aesthetics are combined in the new decorative panels made of natural glass.
- To ensure safety, glass panels are equipped with pre-installed grilles that are securely fixed to the fan. This prevents heavy glass from falling in case of improper installation.



GENERAL COMPATIBILITY CHART

	DPA 100/180 Glas	DPA 100/180 Glas Red	DPA 100/180 Glas Black	DPO 100/180 Glas	DPO 100/180 Glas Red	DPO 100/180 Glas Black	DPO 125/180 Glas	DPO 125/180 Glas Red	DPO 125/180 Glas Black
Omega 100				•	•	•			
Omega 125							•	•	•
DPK 100	•	•	•						

MOON

WITH DECORATIVE FRONT PANEL

Low noise and low power exhaust axial fan with air flow up to 155 m³/h



Air flow:
up to 155 m³/h
43 l/s



Power:
from 8 W
SFP:
from 0.33 W/l/s



Noise level:
from 27 dBA



Features



- Continuous or periodic exhaust ventilation of bathroom, showers, kitchens and other residential premises.
- Wall and ceiling mounting.
- Modern design and aesthetic look.
- The casing, impeller and the front panel are made of high-quality and UV-resistant ABS plastic.
- The aerodynamic design of the impeller ensures high air flow and low noise level.
- The fan outlet pipe incorporates specially designed air rectifiers to reduce air turbulence, noise level and increase air pressure.
- The fan is equipped with a specially designed backdraft damper to prevent back flow and heat losses during the fan standby.
- Ventilation shaft mounting or connection to Ø 100 mm and Ø 125 mm air ducts.

Motor



- Reliable motor with low energy demand.
- Designed for continuous operation and requires no maintenance.
- Equipped with overheating protection.
- Equipped with ball bearings.

Options



Model	Moon 100 / Moon 100 (220-240V/60Hz) / Moon 125					
Option	S	T	TR	ST	H	SH
Pull cord switch	•			•		•
Turn-on delay timer			•	•	•	•
Turn-off delay timer		•	•	•	•	•
Humidity sensor					•	•

- Turn-on delay timer**
 - Turn-on delay time of 45 seconds.
- Turn-off delay timer**
 - Adjustable delay from 2 to 30 minutes.
- Humidity sensor**
 - Humidity sensor activation threshold is adjustable from 60 % to 90 %.

Control

Manual:

- The fan is operated via a light switch (not included in the delivery set).
- The fan is operated via the built-in pull cord switch «S» (option).

Automatic:

- By the MCD 60/0.3 electronic control unit. The control unit is supplied separately.
- By the timer (option). When the fan is turned on by the external switch, the turn-on delay timer is activated for 10 seconds up to 2 minutes. After the external switch is turned off, the fan keeps operating for a set turn-off delay time period, adjustable from 2 to 30 minutes.
- By the timer and the humidity sensor (option). If the humidity level in the room exceeds the set value (60–90 %), the fan switches on automatically and operates until the humidity level drops to the standard level. Then the fan continues operating within the time period according to the turn-off delay timer setting (from 2 to 30 minutes) and shuts down.

Accessories

Duct system



BlauPlast

Flexible air ducts



BlauFlex

Grilles and hoods



Decor, GM

Speed controllers



CDT E1.8

MCD 60/0.3

Clamps



K, KZ

MOON

WITH DECORATIVE FRONT PANEL

Overall dimensions and mounting

- o The fan is installed directly into the ventilation shaft.
- o Flexible duct connection is recommended in case of the remote ventilation shaft location. The air duct is connected to the fan exhaust spigot with a clamp.
- o Fixation to the wall or ceiling with screws.

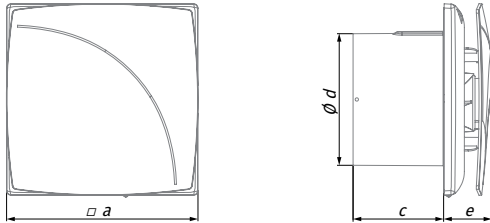

Dimensions [mm]	a	c	Ø d	e
Moon 100	180	79	99	38
Moon 125	180	85	124	45

Designation key			
Model	100	(220-240V/60Hz)	H
Model	Spigot diameter	Frequency 60 Hz	Option

Technical data

Model	Moon 100	Moon 100 (220-240V/60Hz)	Moon 125
Voltage [V]	220-240	220-240	220-240
Frequency [Hz]	50	60	50
Power [W]	8	8	18
Current [A]	0.05	0.05	0.11
RPM [min ⁻¹]	2000	2000	2200
Air flow [m ³ /h (l/s)]	85 (24)	85 (24)	155 (43)
SFP [W/l/s]	0.33	0.33	0.42
Sound pressure level [dBA]*	27	27	32
Weight [kg]	0.51	0.51	0.75

* Sound pressure level measured in free space at a distance of 3 meters from the fan.

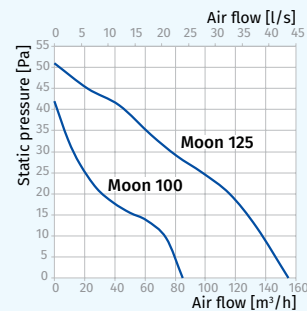

Application example



HI-FI

WITH DECORATIVE FRONT PANEL

Low noise and low power exhaust axial fan with air flow up to 155 m³/h



Air flow:
up to 155 m³/h
43 l/s



Power:
from 8 W
SFP:
from 0.33 W/l/s



Noise level:
from 27 dBA



Features



- Continuous or periodic exhaust ventilation of bathroom, showers, kitchens and other residential premises.
- Wall and ceiling mounting.
- Modern design and aesthetic look.
- The casing, impeller and the front panel are made of high-quality and UV-resistant ABS plastic.
- The aerodynamic design of the impeller ensures high air flow and low noise level.
- The fan outlet pipe incorporates specially designed air rectifiers to reduce air turbulence, noise level and increase air pressure.
- The fan is equipped with a specially designed backdraft damper to prevent back flow and heat losses during the fan standby.
- Ventilation shaft mounting or connection to Ø 100 mm and Ø 125 mm air ducts.

Motor



- Reliable motor with low energy demand.
- Designed for continuous operation and requires no maintenance.
- Equipped with overheating protection.
- Equipped with ball bearings.

Options



Model	Hi-Fi 100 / Hi-Fi 100 (220-240V/60Hz) / Hi-Fi 125					
Option	S	T	TR	ST	H	SH
Pull cord switch	•			•		•
Turn-on delay timer			•	•	•	•
Turn-off delay timer		•	•	•	•	•
Humidity sensor					•	•

- Turn-on delay timer**
 - Turn-on delay time of 45 seconds.
- Turn-off delay timer**
 - Adjustable delay from 2 to 30 minutes.
- Humidity sensor**
 - Humidity sensor activation threshold is adjustable from 60 % to 90 %.

Control

Manual:

- The fan is operated via a light switch (not included in the delivery set).
- The fan is operated via the built-in pull cord switch «S» (option).

Automatic:

- By the MCD 60/0.3 electronic control unit. The control unit is supplied separately.
- By the timer (option). When the fan is turned on by the external switch, the turn-on delay timer is activated for 10 seconds up to 2 minutes. After the external switch is turned off, the fan keeps operating for a set turn-off delay time period, adjustable from 2 to 30 minutes.
- By the timer and the humidity sensor (option). If the humidity level in the room exceeds the set value (60–90 %), the fan switches on automatically and operates until the humidity level drops to the standard level. Then the fan continues operating within the time period according to the turn-off delay timer setting (from 2 to 30 minutes) and shuts down.

Accessories

Duct system



BlauPlast

Flexible air ducts



BlauFlex

Grilles and hoods



Decor, GM

Speed controllers



CDT E1.8

MCD 60/0.3

Clamps



K, KZ

HI-FI

WITH DECORATIVE FRONT PANEL

Overall dimensions and mounting

- o The fan is installed directly into the ventilation shaft.
- o Flexible duct connection is recommended in case of the remote ventilation shaft location. The air duct is connected to the fan exhaust spigot with a clamp.
- o Fixation to the wall or ceiling with screws.

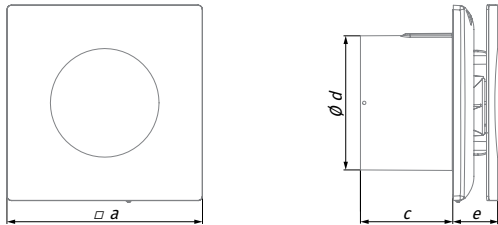

Dimensions [mm]	a	c	∅ d	e
Hi-Fi 100	180	79	99	38
Hi-Fi 125	180	85	124	41

Designation key			
Hi-Fi	100	(220-240V/60Hz)	H
Model	Spigot diameter	Frequency 60 Hz	Option

Technical data

Model	Hi-Fi 100	Hi-Fi 100 (220-240V/60Hz)	Hi-Fi 125
Voltage [V]	220-240	220-240	220-240
Frequency [Hz]	50	60	50
Power [W]	8	8	18
Current [A]	0.05	0.05	0.11
RPM [min ⁻¹]	2000	2000	2200
Air flow [m ³ /h (l/s)]	85 (24)	85 (24)	155 (43)
SFP [W/l/s]	0.33	0.33	0.42
Sound pressure level [dBA]*	27	27	32
Weight [kg]	0.51	0.51	0.75

* Sound pressure level measured in free space at a distance of 3 meters from the fan.

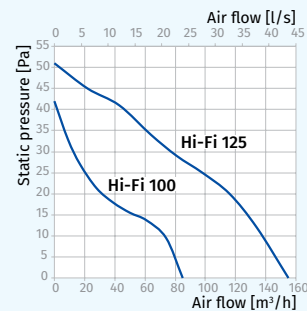

CE GS IP44

Application example



BAVARIA

WITH DECORATIVE FRONT PANEL

Low noise and low power exhaust axial fan with air flow up to 155 m³/h



Air flow:
up to 155 m³/h
43 l/s



Power:
from 8 W

SFP:
from 0.33 W/l/s



Noise level:
from 27 dBA



Features



- Continuous or periodic exhaust ventilation of bathroom, showers, kitchens and other residential premises.
- Wall and ceiling mounting.
- Modern design and aesthetic look.
- The casing, impeller and the front panel are made of high-quality and UV-resistant ABS plastic.
- The aerodynamic design of the impeller ensures high air flow and low noise level.
- The fan outlet pipe incorporates specially designed air rectifiers to reduce air turbulence, noise level and increase air pressure.
- The fan is equipped with a specially designed backdraft damper to prevent back flow and heat losses during the fan standby.
- Ventilation shaft mounting or connection to Ø 100 mm and Ø 125 mm air ducts.

Motor



- Reliable motor with low energy demand.
- Designed for continuous operation and requires no maintenance.
- Equipped with overheating protection.
- Equipped with ball bearings.

Options



Model	Bavaria 100 / Bavaria 100 (220-240V/60Hz) / Bavaria 125					
Option	S	T	TR	ST	H	SH
Pull cord switch	•			•		•
Turn-on delay timer			•	•	•	•
Turn-off delay timer		•	•	•	•	•
Humidity sensor					•	•

- Turn-on delay timer**
 - Turn-on delay time of 45 seconds.
- Turn-off delay timer**
 - Adjustable delay from 2 to 30 minutes.
- Humidity sensor**
 - Humidity sensor activation threshold is adjustable from 60 % to 90 %.

Control

Manual:

- The fan is operated via a light switch (not included in the delivery set).
- The fan is operated via the built-in pull cord switch «S» (option).

Automatic:

- By the MCD 60/0.3 electronic control unit. The control unit is supplied separately.
- By the timer (option). When the fan is turned on by the external switch, the turn-on delay timer is activated for 10 seconds up to 2 minutes. After the external switch is turned off, the fan keeps operating for a set turn-off delay time period, adjustable from 2 to 30 minutes.
- By the timer and the humidity sensor (option). If the humidity level in the room exceeds the set value (60–90 %), the fan switches on automatically and operates until the humidity level drops to the standard level. Then the fan continues operating within the time period according to the turn-off delay timer setting (from 2 to 30 minutes) and shuts down.

Accessories

Duct system



BlauPlast

Flexible air ducts



BlauFlex

Grilles and hoods



Decor, GM

Speed controllers



CDT E1.8

MCD 60/0.3

Clamps



K, KZ

BAVARIA

WITH DECORATIVE FRONT PANEL

Overall dimensions and mounting

- o The fan is installed directly into the ventilation shaft.
- o Flexible duct connection is recommended in case of the remote ventilation shaft location. The air duct is connected to the fan exhaust spigot with a clamp.
- o Fixation to the wall or ceiling with screws.

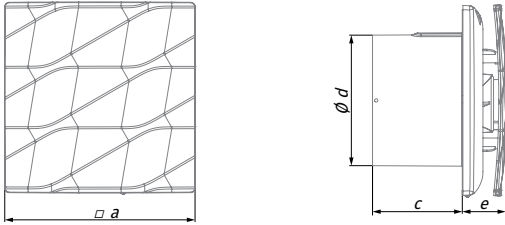

Dimensions [mm]	a	c	Ø d	e
Bavaria 100	180	79	99	38
Bavaria 125	180	85	124	41

Designation key			
Bavaria	100	(220-240V/60Hz)	H
Model	Spigot diameter	Frequency 60 Hz	Option

Technical data

Model	Bavaria 100	Bavaria 100 (220-240V/60Hz)	Bavaria 125
Voltage [V]	220-240	220-240	220-240
Frequency [Hz]	50	60	50
Power [W]	8	8	18
Current [A]	0.05	0.05	0.11
RPM [min ⁻¹]	2000	2000	2200
Air flow [m ³ /h (l/s)]	85 (24)	85 (24)	155 (43)
SFP [W/l/s]	0.33	0.33	0.42
Sound pressure level [dBA]*	27	27	32
Weight [kg]	0.51	0.51	0.75

* Sound pressure level measured in free space at a distance of 3 meters from the fan.

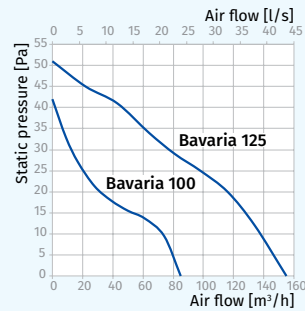

CE GS IP44

Application example



QUATRO

WITH DECORATIVE FRONT PANEL

Features



- Wall and ceiling mounting.
- **Quatro (127-220V/60Hz)** series models are equipped with specially designed motors compatible with both 127 V and 220 V power mains.
- Easy maintenance.
- Low noise impeller.
- Continuous operation.
- Backdraft damper.
- Ball bearing motor.
- Available in aluminium (Quatro Hi-Tech) and chrome (Quatro Hi-Tech Chrome) finish.
- 5 year warranty.



Air flow:
up to 265 m³/h
74 l/s



Power:
from 14 W
SFP:
from 0.33 W/l/s



Noise level:
from 33 dBA



Hi-Tech Chrome



Hi-Tech



Options



Model	Quatro 100/125/150				
	S	T	ST	H	SH
Pull cord switch	•		•		•
Timer		•	•	•	•
Humidity sensor				•	•

- Turn-off delay adjustable from 2 to 30 min.
- Humidity setpoint adjustable from 60 % up to 90 %.

Overall dimensions and mounting

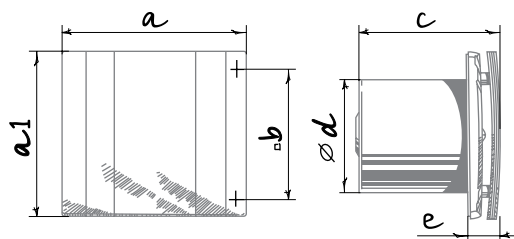

Dimensions [mm]	a	a1	b	c	Ø d	e
Quatro 100	171	151	108	128	100	32
Quatro 125	201	178	113	136	125	35
Quatro 150	236	207	165	157	150	38

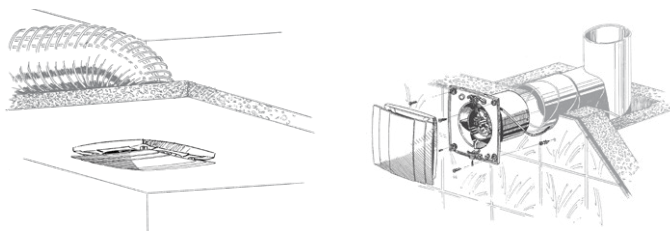

Designation key

Quatro	Chrome	100	S	(127-220V/60Hz)
Model	Colour	Spigot diameter	Option	Voltage

Technical data

Model	Quatro 100	Quatro 125	Quatro 150
Voltage [V/Hz]	220-240/50	220-240/50	220-240/50
Power [W]	14	16	24
Current [A]	0,085	0,1	0,13
RPM [min ⁻¹]	2300	2400	2400
Air flow [m ³ /h (l/s)]	88 (24)	167 (46)	265 (74)
SFP [W/l/s]	0,57	0,34	0,33
Sound pressure level [dBA]*	33	34	37

* Sound pressure level measured in free space at a distance of 3 meters from the fan.

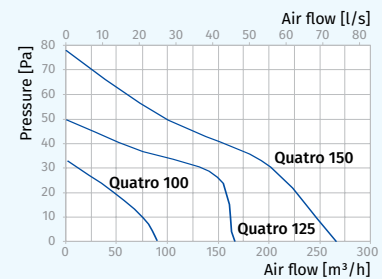

Model	Quatro 100 (127-220V/60Hz)		Quatro 125 (127-220V/60Hz)		Quatro 150 (127-220V/60Hz)	
Voltage [V/Hz]	127/60	220/60	127/60	220/60	127/60	220/60
Power [W]	10	9	16	15	25	25
Current [A]	0,115	0,054	0,119	0,102	0,175	0,338
RPM [min ⁻¹]	2500	2500	2400	2400	2350	2350
Air flow [m ³ /h (l/s)]	82 (23)	82 (23)	170 (47)	170 (47)	240 (67)	240 (67)
SFP [W/l/s]	0,44	0,40	0,34	0,32	0,37	0,37
Sound pressure level [dBA]*	33	33	35	35	37	37

* Sound pressure level measured in free space at a distance of 3 meters from the fan.

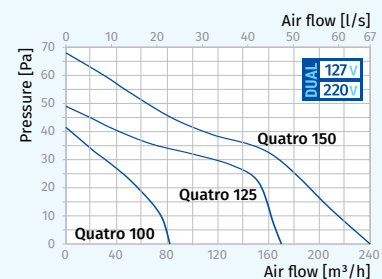

Accessories

Duct system	Flexible air ducts	Grilles and hoods	Speed controllers	Clamps
BlauPlast	BlauFlex	Decor, GM	CDT E1.8	MCD 60/0.3

AUTO

CLASSIC MODELS

Features



- Wall mounting
- Easy maintenance
- Continuous operation
- Automatic shutters
- Ball bearing motor
- 5 year warranty



Air flow:
up to 295 m³/h
82 l/s



Power:
from 18 W
SFP:
from 0.32 W/l/s



Noise level:
from 34 dBA



Options



Model	Auto 100/125/150					
Option	S	T	ST	H	SH	IR
Pull cord switch	•		•		•	
Timer		•	•	•	•	
Humidity sensor				•	•	
Motion sensor						•

• Timer

- Turn-off delay adjustable from 2 to 30 min.

• Humidity sensor

- Humidity setpoint adjustable from 60 % up to 90 %.

• Motion sensor

- Detection range from 1 up to 4 m.
- Detection angle up to 100°.

Overall dimensions and mounting

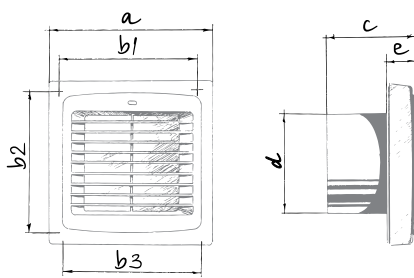

Dimensions [mm]	a	b1	b2	b3	c	∅ d	e
Auto 100	166	150	150	150	90	100	30
Auto 125	186	128	173	174	98	125	33
Auto 150	210	150	195	196	115	150	34

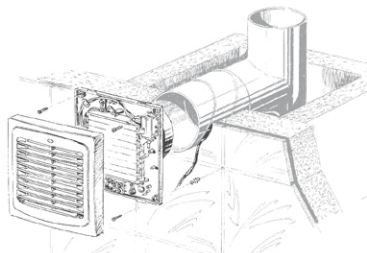

Technical data

Model	Auto 100	Auto 125	Auto 150
Voltage [V/Hz]	220-240/50	220-240/50	220-240/50
Power [W]	18	22	26
Current [A]	0.085	0.1	0.13
RPM [min ⁻¹]	2300	2400	2400
Air flow [m ³ /h (l/s)]	98 (27)	185 (51)	295 (82)
SFP [W/l/s]	0.66	0.43	0.32
Sound pressure level [dBA]*	34	35	39

* Sound pressure level measured in free space at a distance of 3 meters from the fan.

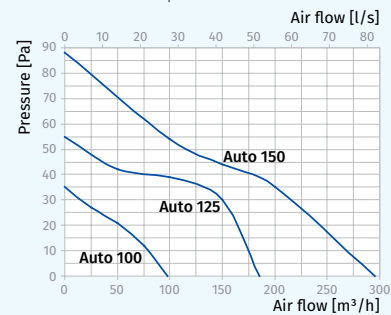

Designation key

Auto	100	ST
Model	Spigot diameter	Option

Accessories

Duct system	Flexible air ducts	Grilles and hoods	Speed controllers	Clamps
BlauPlast	BlauFlex	Decor, GM	CDT E1.8 MCD 60/0.3	K, KZ

AERO

CLASSIC MODELS

Features



- Wall and ceiling mounting
- Aero (127-220V/60Hz)** series models are equipped with specially designed motors compatible with both 127 V and 220 V power mains
- Easy maintenance
- Continuous operation
- Backdraft damper
- Ball bearing motor
- Available in Vintage plastic with a chrome finish (Aero Chrome)
- 5 year warranty



Air flow:
up to 309 m³/h
86 l/s



Power:
from 14 W
SFP:
from 0.28 W/l/s



Noise level:
from 38 dBA



Chrome



Vintage

Options



Model	Aero 100/125/150				
	S	T	ST	H	SH
Pull cord switch	•		•		•
Timer		•	•	•	•
Humidity sensor				•	•

- Turn-off delay adjustable from 2 to 30 min.
- Humidity setpoint adjustable from 60 % up to 90 %.

Overall dimensions and mounting

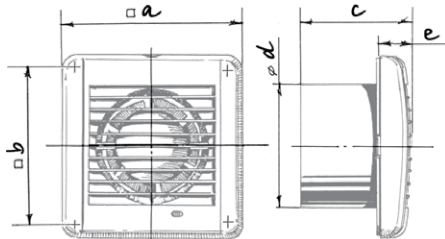

Dimensions [mm]	a	b	c	Ø d	e
Aero 100	144	122	92.5	100	29.5
Aero 125	168	144	97	125	30
Aero 150	198	170	119	150	30

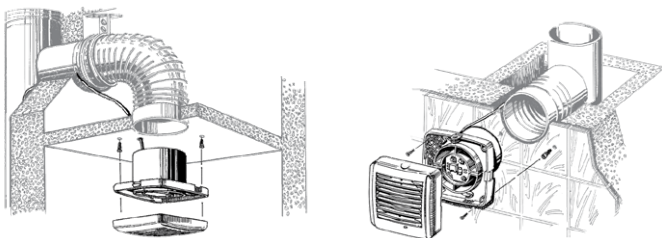

Designation key				
Aero	Chrome	100	S	(127-220V/60Hz)
Model	Colour	Spigot diameter	Option	Voltage

Technical data

Model	Aero 100	Aero 125	Aero 150
Voltage [V/Hz]	220-240/50	220-240/50	220-240/50
Power [W]	14	16	24
Current [A]	0.085	0.1	0.13
RPM [min ⁻¹]	2300	2400	2400
Air flow [m ³ /h (l/s)]	102 (28)	193 (54)	309 (86)
SFP [W/l/s]	0.49	0.3	0.28
Sound pressure level [dBA]*	38	39	40

* Sound pressure level measured in free space at a distance of 3 meters from the fan.

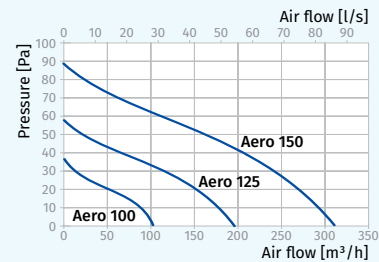

Model	Aero 100 (127-220V/60Hz)		Aero 125 (127-220V/60Hz)		Aero 150 (127-220V/60Hz)	
Voltage [V/Hz]	127/60	220/60	127/60	220/60	127/60	220/60
Power [W]	10	9	16	15	25	25
Current [A]	0.115	0.054	0.119	0.102	0.175	0.338
RPM [min ⁻¹]	2500	2500	2400	2400	2350	2350
Air flow [m ³ /h (l/s)]	92 (26)	92 (26)	190 (53)	190 (53)	270 (75)	270 (75)
SFP [W/l/s]	0.39	0.35	0.30	0.28	0.33	0.33
Sound pressure level [dBA]*	34	34	36	36	39	39

* Sound pressure level measured in free space at a distance of 3 meters from the fan.

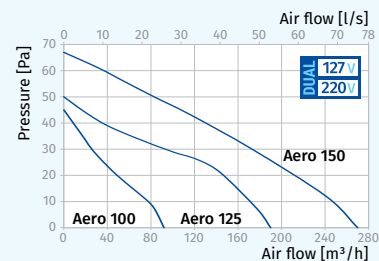

Accessories

Duct system	Flexible air ducts	Grilles and hoods	Speed controllers	Clamps
BlauPlast	BlauFlex	Decor, GM	CDT E1.8	MCD 60/0.3

BRAVO

CLASSIC MODELS

Features



- Wall and ceiling mounting
- Low noise impeller
- Easy maintenance
- Continuous operation
- Backdraft damper
- Ball bearing motor
- Available in chrome (Bravo Chrome) and platinum (Bravo Platinum) finish
- 5 year warranty



Air flow:
up to 305 m³/h
85 l/s



Power:
from 14 W
SFP:
from 0.28 W/l/s



Noise level:
from 35 dBA



Chrome



Platinum

Options



Model	Bravo 100/125/150					
Option	S	T	ST	H	SH	IR
Pull cord switch	•		•		•	
Timer		•	•	•	•	
Humidity sensor				•	•	
Motion sensor						•

- **Timer**
 - Turn-off delay adjustable from 2 to 30 min.
- **Humidity sensor**
 - Humidity setpoint adjustable from 60 % up to 90 %.
- **Motion sensor**
 - Detection range from 1 up to 4 m.
 - Detection angle up to 100°.

Overall dimensions and mounting

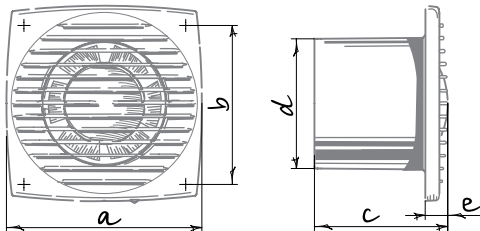

Dimensions [mm]	a	b	c	Ø d	e
Bravo 100	150	122	102	100	17
Bravo 125	176	144	104	125	17
Bravo 150	205	174	124	150	19

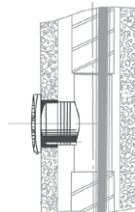

Designation key

Bravo	Chrome	100	S	(127-220V/60Hz)
Model	Colour	Spigot diameter	Option	Voltage

Technical data

Model	Bravo 100	Bravo 125	Bravo 150
Voltage [V/Hz]	220-240/50	220-240/50	220-240/50
Power [W]	14	16	24
Current [A]	0.085	0.1	0.13
RPM [min ⁻¹]	2300	2400	2400
Air flow [m ³ /h (l/s)]	101 (28)	192 (53)	305 (85)
SFP [W/l/s]	0.5	0.3	0.28
Sound pressure level [dBA]*	35	37	39

* Sound pressure level measured in free space at a distance of 3 meters from the fan.

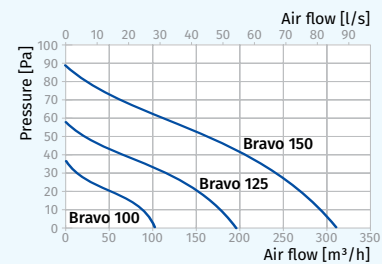

Model	Bravo 100 (127-220V/60Hz)		Bravo 125 (127-220V/60Hz)		Bravo 150 (127-220V/60Hz)	
Voltage [V/Hz]	127/60	220/60	127/60	220/60	127/60	220/60
Power [W]	10	9	16	15	25	25
Current [A]	0.115	0.054	0.119	0.102	0.175	0.338
RPM [min ⁻¹]	2500	2500	2400	2400	2350	2350
Air flow [m ³ /h (l/s)]	91 (25)	91 (25)	189 (53)	189 (53)	266 (74)	266 (74)
SFP [W/l/s]	0.4	0.36	0.3	0.29	0.34	0.34
Sound pressure level [dBA]*	33	33	34	34	38	38

* Sound pressure level measured in free space at a distance of 3 meters from the fan.

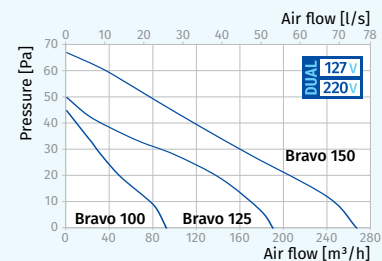

Accessories

Duct system	Flexible air ducts	Grilles and hoods	Speed controllers	Clamps
BlauPlast	BlauFlex	Decor, GM	CDT E1.8	MCD 60/0.3

SLIM

CLASSIC MODELS

Features



- o Specially designed for exhaust ventilation
- o Wall and ceiling mounting
- o Easy installation and maintenance
- o Continuous operation
- o Backdraft damper
- o Ball bearing motor



Air flow:
up to 305 m³/h
85 l/s



Power:
from 14 W
SFP:
from 0.28 W/l/s



Noise level:
from 33 dBA



Options



Model	Slim 100/120/125/150				
	S	T	ST	H	SH
Pull cord switch	•		•		•
Timer		•	•	•	•
Humidity sensor				•	•

- o Turn-off delay adjustable from 2 to 30 min.
- o Humidity setpoint adjustable from 60 % up to 90 %.

Technical data

	Slim 100	Slim 120	Slim 125	Slim 150
Voltage [V/Hz]	220-240/50	220-240/50	220-240/50	220-240/50
Power [W]	14	17	16	24
Current [A]	0.085	0.1	0.1	0.13
RPM [min ⁻¹]	2300	2400	2400	2400
Maximum air capacity [m ³ /h (l/s)]	105 (29)	184 (51)	190 (53)	305 (85)
SFP [W/l/s]	0.48	0.33	0.30	0.28
Sound pressure level [dBA]*	33	35	34	37
Weight [kg]	0.6	0.73	0.73	0.92

* Sound pressure level measured in free space at a distance of 3 meters from the fan.

Overall dimensions and mounting

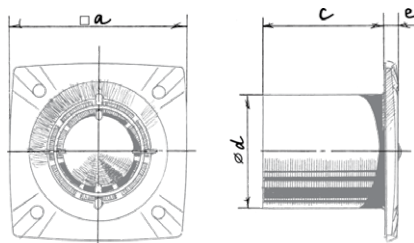

Dimensions [mm]	a	c	∅ d	e
Slim 100	150	87	100	13
Slim 120	176	94	117	13
Slim 125	176	101	125	13
Slim 150	205	118	150	13

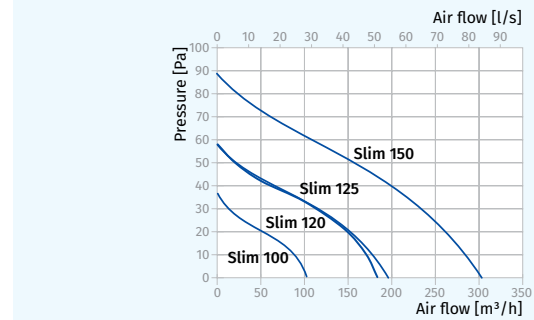

Designation key

Slim	100	SH
Model	Spigot diameter	Option

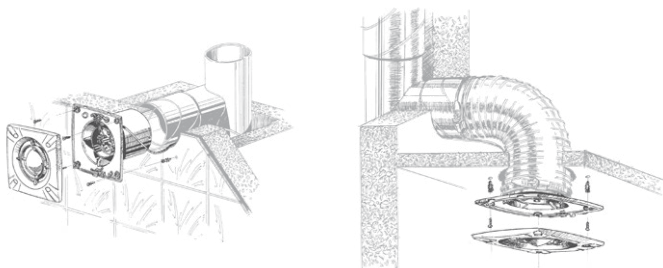

Accessories

Duct system	Flexible air ducts	Grilles and hoods	Speed controllers	Clamps
BlauPlast	BlauFlex	Decor, GM	CDT E1.8 MCD 60/0.3	K, KZ

LINE

CLASSIC MODELS

Features



- For exhaust ventilation of residential premises
- Wall surface or ceiling mounting
- Low noise impeller
- Easy maintenance
- Continuous operation
- Backdraft damper
- Ball bearing motor



Air flow:
up to 292 m³/h
81 l/s



Power:
from 14 W
SFP:
from 0.3 W/l/s



Noise level:
from 34 dBA



Options



Model	Line 100/125/150					
	S	T	TR	ST	H	SH
Option						
Pull cord switch	•			•		•
Turn-on delay timer			•	•	•	•
Turn-off delay timer		•	•	•	•	•
Humidity sensor					•	•

- Turn-on delay timer**
 - Delay time 45 seconds.
- Turn-off delay timer**
 - Adjustable delay from 2 to 30 minutes.
- Humidity sensor**
 - Humidity sensor activation threshold is adjustable from 60 % to 90 %.

Overall dimensions and mounting

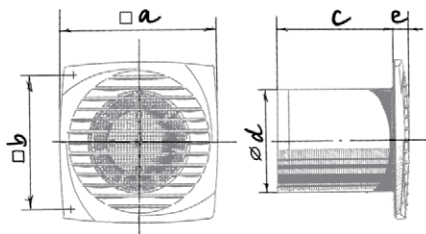

Dimensions [mm]	a	b	c	Ø d	e
Line 100	150	120	109	100	12.5
Line 120	176	140	109	117	12.5
Line 125	176	140	114	125	12.5
Line 150	205	165	132	150	13

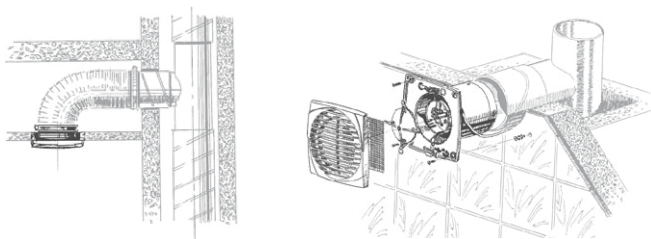

Technical data

Model	Line 100	Line 120	Line 125	Line 150
Voltage [V/Hz]	220-240/50	220-240/50	220-240/50	220-240/50
Power [W]	14	17	16	24
Current [A]	0.085	0.1	0.1	0.13
RPM [min ⁻¹]	2300	2400	2400	2400
Air flow [m ³ /h (l/s)]	95 (26)	174 (48)	180 (50)	292 (81)
SFP [W/l/s]	0.53	0.35	0.32	0.3
Sound pressure level [dBA]*	34	36	35	38

* Sound pressure level measured in free space at a distance of 3 meters from the fan.

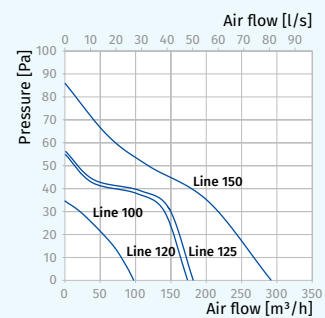

Designation key

Line	100	S
Model	Spigot diameter	Option

Accessories

Duct system	Flexible air ducts	Grilles and hoods	Speed controllers	Clamps
BlauPlast	BlauFlex	Decor, GM	CDT E1.8 MCD 60/0.3	K, KZ

JET

CLASSIC MODELS

Features



- o Wall and ceiling mounting
- o Ball bearing motor
- o Easy mounting with the help of locking tabs or screws
- o Light indication for fan operation
- o Modern design
- o Available in aluminium finish (Jet Hi-Tech)
- o 5 year warranty



Air flow:
95 m³/h
26 l/s



Power:
14 W
SFP:
0.53 W/l/s



Noise level:
34 dBA



Jet Hi-Tech

Options



Model	Jet 100	
Option	T	H
Timer	•	•
Humidity sensor		•

- o Turn-off delay adjustable from 2 to 30 min.
- o Humidity setpoint adjustable from 60 % up to 90 %.

Overall dimensions and mounting

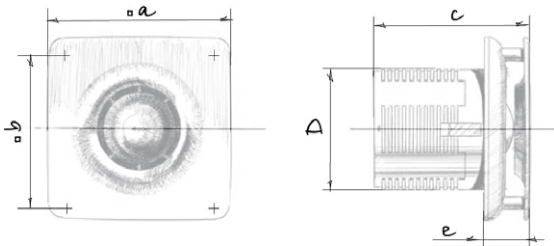

Dimensions [mm]	a	b	c	Ø d	e
Jet 100	150	122	125	98	36

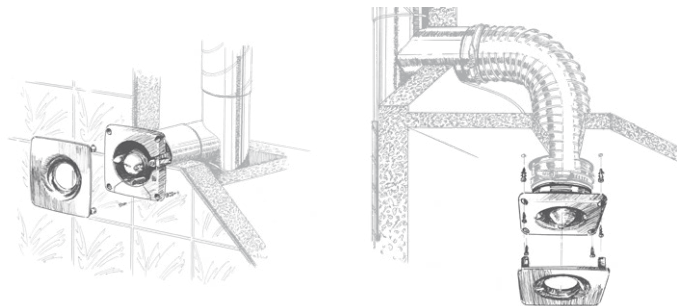

Technical data

Model	Jet 100
Voltage [V/Hz]	220-240/50
Power [W]	14
Current [A]	0.085
RPM [min ⁻¹]	2300
Air flow [m ³ /h (l/s)]	95 (26)
SFP [W/l/s]	0.53
Sound pressure level [dBA]*	34

* Sound pressure level measured in free space at a distance of 3 meters from the fan.

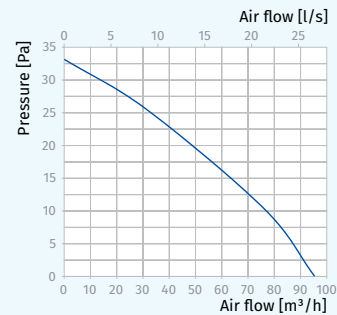

Designation key

Jet	Hi-Tech	100	H
Model	Colour	Spigot diameter	Option

Accessories

Duct system	Flexible air ducts	Grilles and hoods	Speed controllers	Clamps
BlauPlast	BlauFlex	Decor, GM	CDT E1.8 MCD 60/0.3	K, KZ

DECO

CLASSIC MODELS

Features



- Wall and ceiling mounting
- Low noise impeller
- Easy maintenance
- Continuous operation
- Backdraft damper
- Ball bearing motor
- 5 year warranty



Air flow:
up to 298 m³/h
83 l/s



Power:
from 14 W
SFP:
from 0.29 W/l/s



Noise level:
from 37 dBA



Options



Model	Deco 100/125/150
Option	T
Timer	•

- Turn-off delay adjustable from 2 to 30 min.

Overall dimensions and mounting

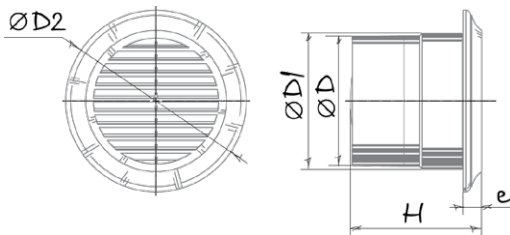

Dimensions [mm]	Ø D	Ø D1	Ø D2	H	e
Deco 100	99	100.4	140	128.5	14
Deco 125	123.5	128.6	165	133.5	14
Deco 150	149.5	154	188.5	145	14

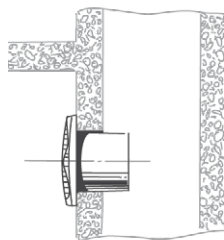

Technical data

Model	Deco 100	Deco 125	Deco 150
Voltage [V/Hz]	220-240/50	220-240/50	220-240/50
Power [W]	14	16	24
Current [A]	0.085	0.1	0.13
RPM [min ⁻¹]	2300	2400	2400
Air flow [m ³ /h (l/s)]	105 (29)	185 (51)	298 (83)
SFP [W/l/s]	0.48	0.31	0.29
Sound pressure level [dBA]*	37	38	40

* Sound pressure level measured in free space at a distance of 3 meters from the fan.

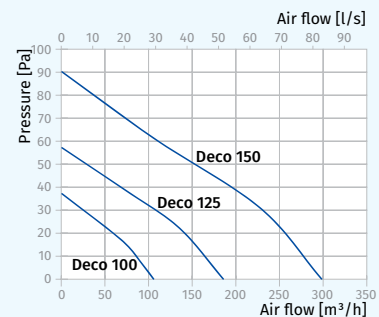

Designation key

Deco	125	T
Model	Spigot diameter	Option

Accessories

Duct system	Flexible air ducts	Grilles and hoods	Speed controllers	Clamps
BlauPlast	BlauFlex	Decor, GM	CDT E1.8 MCD 60/0.3	K, KZ

TUBO

IN-LINE FANS

Features



- o Duct mounting
- o Easy maintenance
- o Low noise impeller
- o Continuous operation
- o Ball bearing motor
- o 5 year warranty



Air flow:
up to 295 m³/h
82 l/s



Power:
from 14 W
SFP:
from 0.3 W/l/s



Noise level:
from 38 dBA



Options



Model	Tubo 100/125/150
Option	T
Timer	•

- o Turn-off delay adjustable from 2 to 30 min.

Overall dimensions and mounting

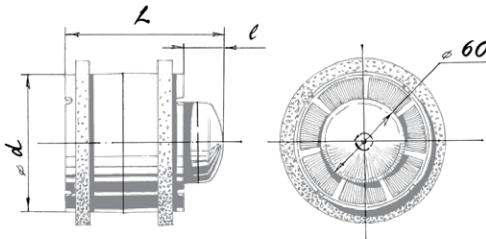

Dimensions [mm]	d	L	l
Tubo 100	99	120	28
Tubo 125	123.5	118	28
Tubo 150	149.5	128	28

Technical data

Model	Tubo 100	Tubo 125	Tubo 150
Voltage [V/Hz]	220-240/50	220-240/50	220-240/50
Power [W]	14	16	30
Current [A]	0.085	0.1	0.13
RPM [min ⁻¹]	2300	2400	2400
Air flow [m ³ /h (l/s)]	102 (28)	195 (54)	295 (82)
SFP [W/l/s]	0.5	0.3	0.37
Sound pressure level [dBA]*	38	39	40

* Sound pressure level measured in free space at a distance of 3 meters from the fan.

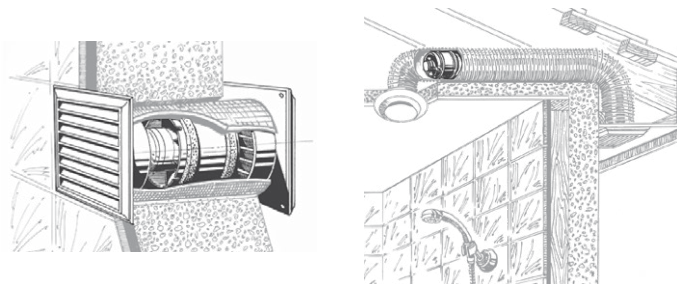
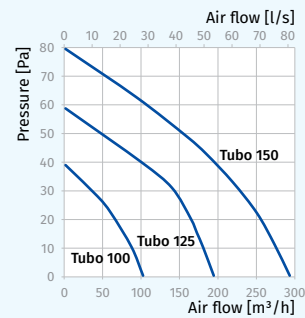

Fixing bracket

Fan with a mounting bracket for mounting to a horizontal or vertical surface.



Tubo-U

Designation key

Tubo	-U	125	T
Model	Mounting bracket	Spigot diameter	Option

Accessories

Air disc valves	Duct system	Flexible air ducts	Grilles and hoods	Speed controllers	Clamps
VPR, VSR, VMR	BlauPlast	BlauFlex	Decor, GM	SGS E1	MCD 60/0.3
					K, KZ

DUCTO

IN-LINE FANS

Low noise axial inline fans for exhaust or supply ventilation with superior air flow up to 375 m³/h



Air flow:
up to 375 m³/h
104 l/s



Power:
from 4.5 W

SFP:
from 0.22 W/l/s



Noise level:
from 22 dBA



Features



- The casing and the impeller are made of high-quality durable plastic.
- The specially designed mixed-flow impeller profile ensures high air flow and low noise level.
- Protection rating IPX4.
- Low energy usage from 4.5 W.
- The models of **Blauberg Ducto** Series are equipped with a single-phase motor and are available in single- or two speed modifications.
- The motors have thermal overheating protection for motor overload prevention.
- Designed for PVC ducting systems or flexible ducts.
- From low to medium air flow motion for short distances at low air resistance.
- Compatible with Ø 100, 125 and 150 mm air ducts.

Options



Ducto Plus – reliable single-phase two-speed motor.

Ducto Power Plus – two-speed high-powered motor.

Ducto T – modification with a regulated timer with the operating time from 2 to 30 minutes.

Ducto W1 – modification with a power cord with an IEC C14 electric plug.

Fixing bracket

Ducto-U – modification with a fixing bracket for flat surface mounting.



Ducto-U

Control



- Manual speed control with a room light switch. It is not included in the delivery set.
- Smooth speed control with a thyristor speed controller (see Electrical Accessories). Several fans may be connected to the same controller. The models with a timer are not compatible with a speed controller.
- Automatic fan control with the MCD 60/0.3 electronic control unit (see Electrical Accessories). The control unit is supplied separately.
- Automatic fan control with the timer T (built-in turn-off delay timer enables the fan operation within 2 to 30 minutes after the fan switching off).

Operation modes of fans with a timer



Updated automatic control for T modifications of Ducto Plus 100, 125, 150 and Ducto Power Plus 150 models enables setting one of four available operation modes. Changeover to another operation mode by means of setting the DIP switch to a respective position.

- **Mode 1** (single-speed mode)
The fan is turned off by default. The fan starts operating with the 1st speed when the switch is closed.
- **Mode 2** (single-speed mode)
The fan is turned off by default. The fan starts operating with the 2nd speed when the switch is closed.
- **Mode 3** (two-speed mode)
The fan operates with the 1st speed by default. The fan switches to the 2nd speed when the switch is closed.
- **Mode 4** (automatic interval mode)
The fan operates at the 1st speed by default. Each set time (adjustable from 1 to 15 hours) the fan switches to the 2nd speed automatically and reverts back to 1st speed after 2–30 minutes operation with maximum capacity.

Designation key

Ducto	-U	Plus	125
Model	Fixing bracket	Options	Spigot diameter

Accessories

Air disc valves



VPR, VSR, VMR

Duct system



BlauPlast

Flexible air ducts



BlauFlex

Grilles and hoods



Decor, GM

Speed controllers



CDT E1.8

Clamps



MCD 60/0.3



K, KZ

DUCTO

IN-LINE FANS

Overall dimensions and mounting

- The fan is mounted into a duct of appropriate size. Fastening with clamps in case of flexible duct connection.
- The mounting bracket enables installation of the fan on horizontal and vertical flat surfaces (Ducto-U model).
- Two fans can be installed in series for higher operation pressure.

Dimensions [mm]	L	Ø D	K
Ducto 100	137.5	100	-
Ducto-U 100	137.5	100	53.5
Ducto 125	161.5	125	-
Ducto-U 125	161.5	125	53.5
Ducto 150	181.5	150	-
Ducto-U 150	181.5	150	53.5

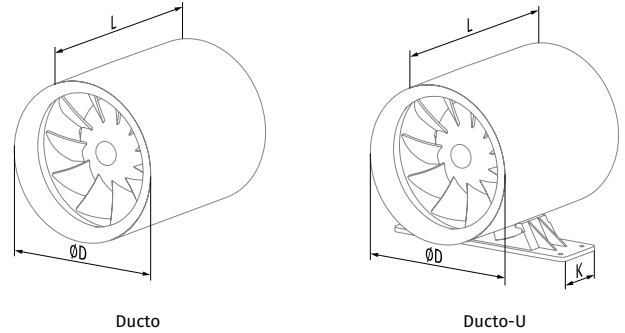

Technical data

Model	Ducto 100		Ducto Plus 100		Ducto 125		Ducto Plus 125		Ducto 150		Ducto Plus 150		Ducto Power Plus 150	
	Speed	-	min	max	-	min	max	-	min	max	min	max		
Voltage [V/Hz]	220-240/50		220-240/50		220-240/50		220-240/50		220-240/50		220-240/50		220-240/50	
Power [W]	7.5	4.5	7.5	13	10	13	22	19	22	22	22	25		
Current [A]	0.049	0.029	0.049	0.085	0.065	0.085	0.095	0.087	0.095	0.103	0.109			
RPM [min ⁻¹]	2100	1650	2100	2250	1950	2250	2250	1950	2250	2300	2600			
Air flow [m ³ /h (l/s)]	110 (31)	75 (21)	110 (31)	215 (60)	155 (43)	215 (60)	340 (94)	250 (69)	340 (94)	285 (79)	375 (104)			
SFP [W/l/s]	0.25	0.22	0.25	0.22	0.23	0.22	0.23	0.27	0.23	0.28	0.24			
Sound pressure level [dBA]*	25	22	25	33	29	33	39	36	39	38	41			
Weight [kg]	0.61	0.61	0.61	0.75	0.75	0.75	1.3	1.3	1.3	1.3	1.3			

* Sound pressure level measured in free space at a distance of 3 meters from the fan.

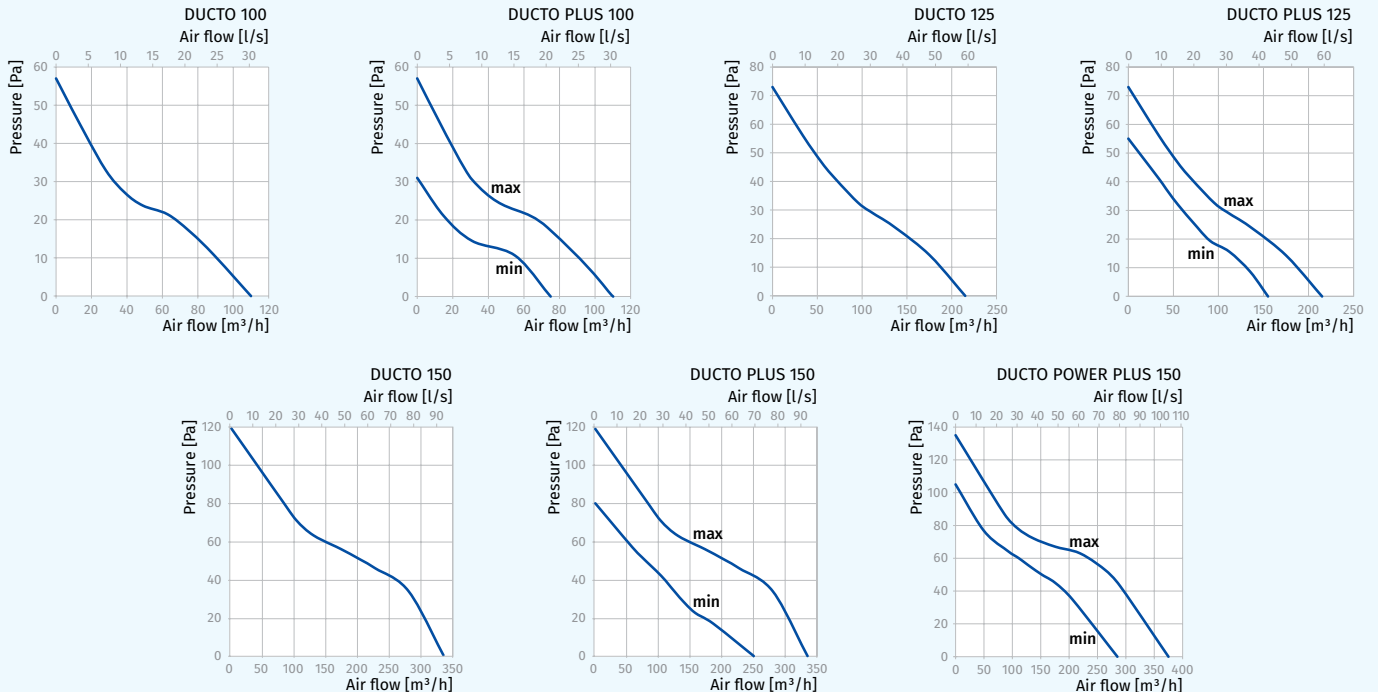

WIND

WINDOW FANS

Features



- Window mounting
- Low noise impeller
- Easy maintenance
- Ball bearing motor
- Continuous operation
- Automatic shutters
- 5 year warranty



Air flow:
up to 295 m³/h
82 l/s



Power:
from 22 W
SFP:
from 0.32 W/l/s



Noise level:
from 35 dBA



Options



Model	Wind 125/150					
Option	S	T	ST	H	SH	IR
Pull cord switch	•		•		•	
Timer		•	•	•	•	•
Humidity sensor				•	•	
Motion sensor						•

- Timer**
 - Turn-off delay adjustable from 2 to 30 min.
- Humidity sensor**
 - Humidity setpoint adjustable from 60 % up to 90 %.
- Motion sensor**
 - Detection range from 1 up to 4 m.
 - Detection angle up to 100°.

Overall dimensions and mounting

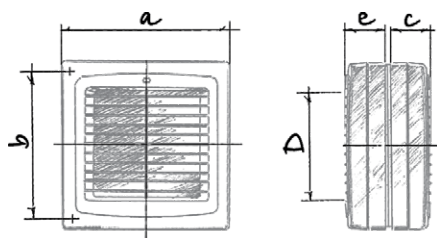

Dimensions [mm]	a	b	e	c	D
Wind 125	186	173	60	53	125
Wind 150	210	195	66	60	150

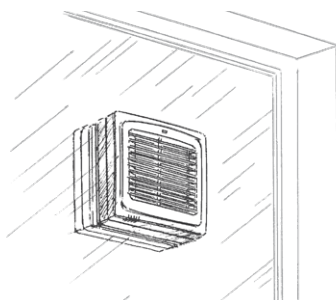

Technical data

Model	Wind 125	Wind 150
Voltage [V/Hz]	220-240/50	220-240/50
Power [W]	22	26
Current [A]	0.1	0.13
RPM [min ⁻¹]	2400	2400
Air flow [m ³ /h (l/s)]	185 (51)	295 (82)
SFP [W/l/s]	0.43	0.32
Sound pressure level [dBA]*	35	41

* Sound pressure level measured in free space at a distance of 3 meters from the fan.

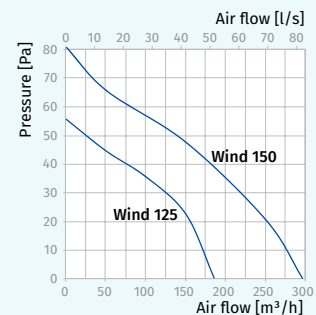

Designation key

Wind	125	ST
Model	Spigot diameter	Option

Accessories

Speed controllers



CDT E1.8



MCD 60/0.3

WIND-K

WINDOW FANS

Features



- Window mounting
- Low noise impeller
- Easy maintenance
- Ball bearing motor
- Continuous operation
- Automatic shutters
- Integrated ventilation hood with backdraft damper
- 5 year warranty



Air flow:
185 m³/h
51 l/s



Power:
22 W
SFP:
0.43 W/l/s



Noise level:
35 dBA



Options



Model	Wind-K 125				
	S	T	ST	H	SH
Pull cord switch	•		•		•
Timer		•	•	•	•
Humidity sensor				•	•

- Turn-off delay time regulated between 2 and 3 min.
- Regulated humidity threshold from 60 to 90 %.

Overall dimensions and mounting

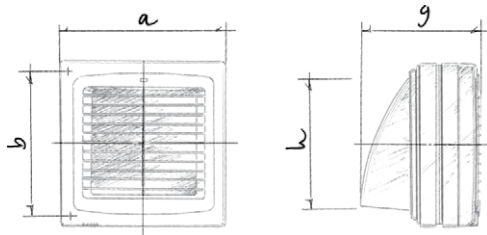

Dimensions [mm]	a	b	g	h
Wind-K 125	186	173	183	160

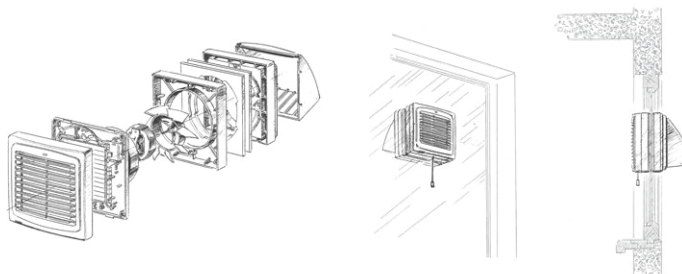

Technical data

Model	Wind-K 125
Voltage [V/Hz]	220-240/50
Power [W]	22
Current [A]	0.1
RPM [min ⁻¹]	2400
Air flow [m ³ /h (l/s)]	185 (51)
SFP [W/l/s]	0.43
Sound pressure level [dBA]*	35

* Sound pressure level measured in free space at a distance of 3 meters from the fan.

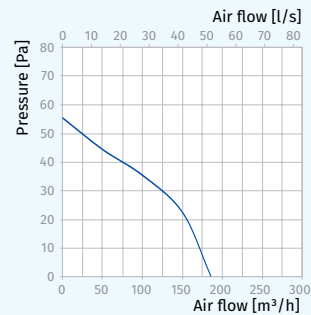

Designation key

Wind	-K	125	SH
Model	With external hood	Spigot diameter	Option



External ventilation hood

Accessories

Speed controllers



CDT E1.8



MCD 60/0.3

CEILEO

CENTRIFUGAL FANS

Centrifugal exhaust low noise and low power fans for ceiling mounting



Air flow:
up to 320 m³/h
89 l/s



Power:
from 20 W

SFP:
from 0.49 W/l/s



Noise level:
from 24 dBA



Features



- Intermittent or continuous ventilation of bathrooms, showers, kitchens and other domestic spaces.
- For high-resistant ventilation systems.
- Integrated LED-light with low energy demand (**Ceileo Light** models).
- Low noise level.
- The centrifugal impeller has forward curved blades for high pressure and low noise.
- The motor impeller is made of high-quality durable ABS plastic.
- The fans also feature a gravity backdraft damper.
- Ingress protection rating IPX4.
- Compatible with Ø 100 or 150 mm air ducts.

Motor

- The Ceileo fans are equipped with reliable asynchronous two-speed motors with overheating protection.
- The maintenance-free permanently lubricated motor bearings are engineered for over 40 000 operating hours of trouble-free operation.

Design

- The casing is made of galvanized steel.
- The clip-on plastic grille ensures easy mounting and cleaning of the fan.
- The modular design enables easy retrofitting with the optional humidity and motion sensors (except for the basic model) or the grille with a light.



- **Ceileo Light** fans are both equipped with an energy efficient LED light.

Power: 10 W
Colour temperature:
3 000 K
Luminous flux:
650 lumens



Power: 60 W

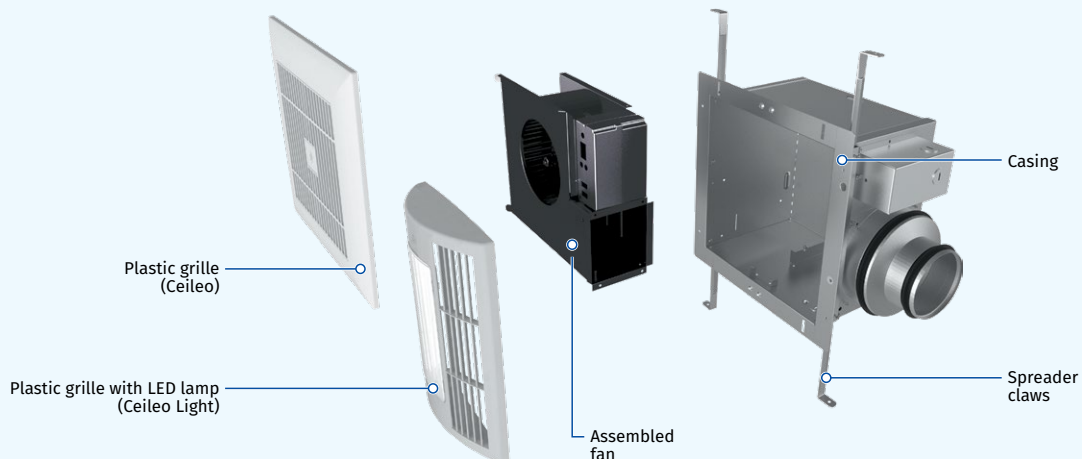

CEILEO

CENTRIFUGAL FANS

Options

Ceileo: Double-speed basic fan model.

Ceileo T: Models with an adjustable turn-off delay timer.

This model can also be retrofitted with an optional humidity or motion sensor (available on a special order basis).

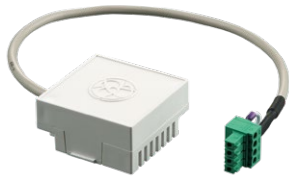

Humidity sensor

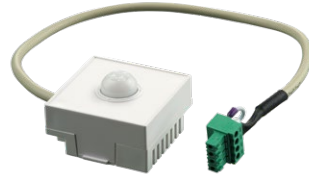

Motion sensor

Control

The built-in control panel of the **Ceileo T** fans enables the following settings:

- turn-off delay
- humidity level
- air flow for modes 1 and 2

Name	Adjustment range for operation modes 1 and 2
Ceileo 200 T	Off / low speed / high speed
Ceileo 250 T	Off / low speed / high speed
Ceileo 300 T	Off / low speed / high speed

Ceileo T control panel



MANUAL CONTROL

The fan is controlled by means of the CDP-2/10 speed switch (available as a specially ordered accessory).



AUTOMATIC CONTROL



Timer "T": The fan is constantly set to the mode 1. The mode 2 is triggered by the light switch closing. Upon the light switch opening the built-in turn-off delay timer keeps the fan running in the mode 2 from 1 to 90 minutes. On elapsing of this period the fan reverts to the mode 1.



Timer "T" and humidity sensor (available as a specially ordered accessory): the fan runs constantly in the mode 1.

If the indoor humidity level exceeds the sensor threshold value set in the 60-90 % range, the fan switches to the mode 2. When the humidity level reverts to the pre-set value, the built-in turn-off delay timer keeps the fan running in the mode 2 from 1 to 90 minutes. On elapsing of this period the fan reverts to the mode 1.



Timer "T" and motion sensor (available as a specially ordered accessory): the fan runs constantly in the mode 1.

If the motion sensor detects movement within its range, the fan goes to the mode 2. When the movement is no longer registered, the built-in turn-off delay timer keeps the fan running in the mode 2 from 1 to 90 minutes. On elapsing of this period the fan reverts to the mode 1.

Overall dimensions

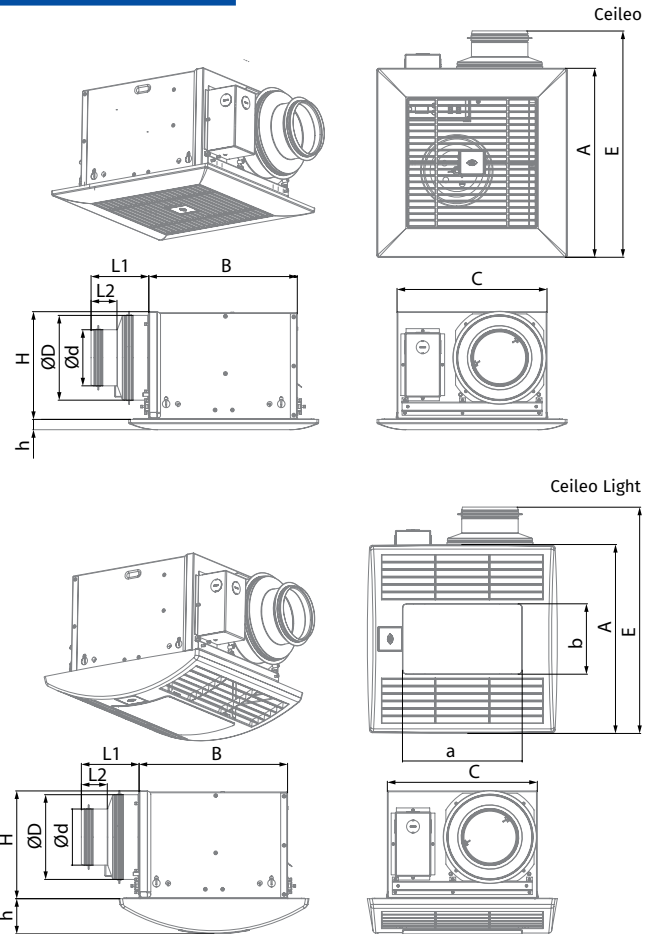

Dimensions [mm]	Ø D	Ø d	L1	L2	A	B	C	E	H	h	a	b
Ceileo 200 / 250	148	98	100	45	330	258	260	395	188	18	-	-
Ceileo 200 / 250 Light	148	98	100	45	330	258	260	395	188	62	208	123
Ceileo 300	149	-	50	-	330	258	260	395	188	18	-	-
Ceileo 300 Light	149	-	50	-	330	258	260	395	188	62	208	123

Mounting

- The fan is integrated into ceiling spaces.
- The fan is attached to the ceiling joists with spreader claws and self-tapping screws.
- The flexible air duct is attached to the fan exhaust spigot with a fixing clamp.



Designation key

Ceileo	200	Light	T
Series	Rated air flow [CFM]	LED-lamp available	Option

CEILEO

CENTRIFUGAL FANS

Technical data

Model	Ceileo 200 (Light) Ceileo 200 (Light) T				Ceileo 250 (Light) Ceileo 250 (Light) T				Ceileo 300 (Light) Ceileo 300 (Light) T			
	min	max	min	max	min	max	min	max	min	max	min	max
Voltage [V/Hz]	230/50		230/60		230/50		230/60		230/50		230/60	
Power [W]	20	29	21	34	23	39	25	50	31	49	35	63
LED-light power [W]**	2 × 10				2 × 10				2 × 10			
RPM [min ⁻¹]	714	1026	588	936	756	1122	732	1140	936	1254	888	1320
Current [A]	0.1	0.13	0.11	0.15	0.12	0.18	0.14	0.22	0.15	0.22	0.17	0.28
Air flow [m ³ /h (l/s)]	130 (36)	210 (58)	130 (36)	225 (63)	170 (47)	260 (72)	160 (44)	270 (75)	220 (61)	300 (83)	200 (56)	320 (89)
SFP [W/l/s]	0.55	0.50	0.58	0.54	0.49	0.54	0.56	0.67	0.51	0.59	0.63	0.71
Sound pressure level [dBA]*	24	27	24	28	25	29	25	30	28	31	27	32
Weight [kg]	5.3 (6.4**)				5.3 (6.4**)				5.1 (6.2**)			
Ingress protection	IPX4				IPX4				IPX4			
SEC class***	C				C				C			

* Sound pressure level measured in free space at a distance of 3 meters from the fan.

** Only for the Light model



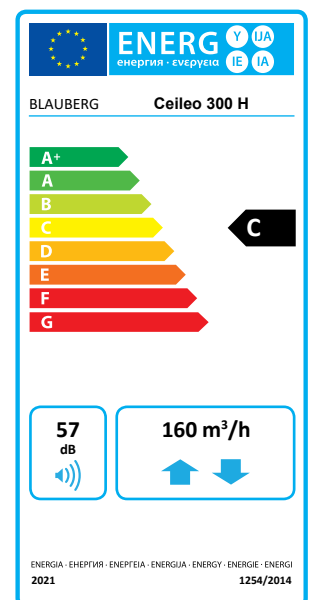
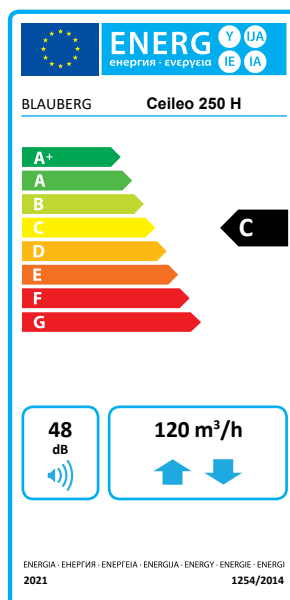
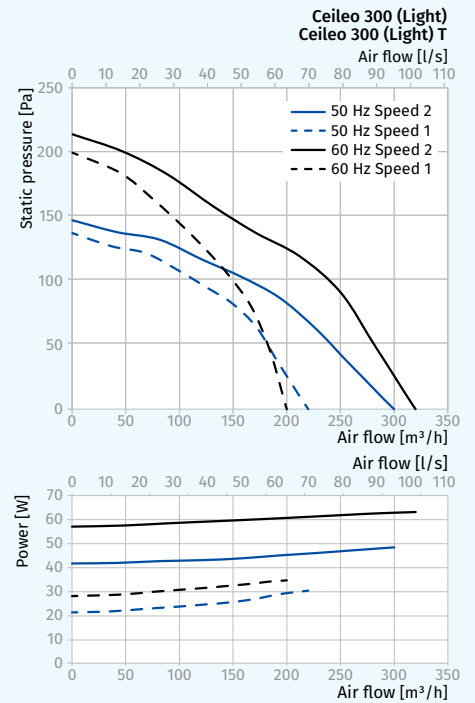
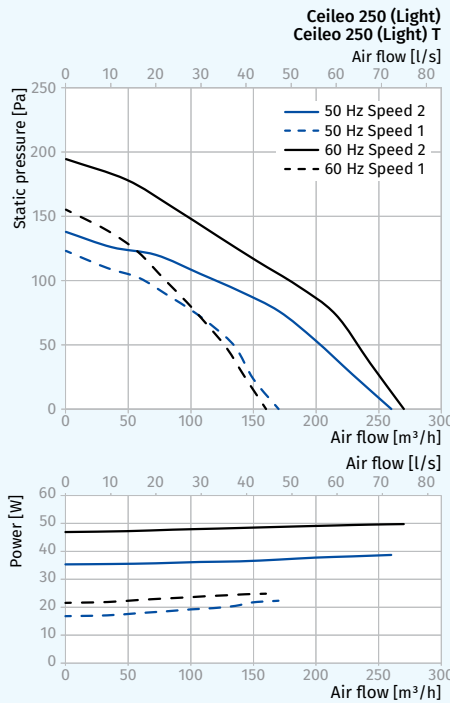
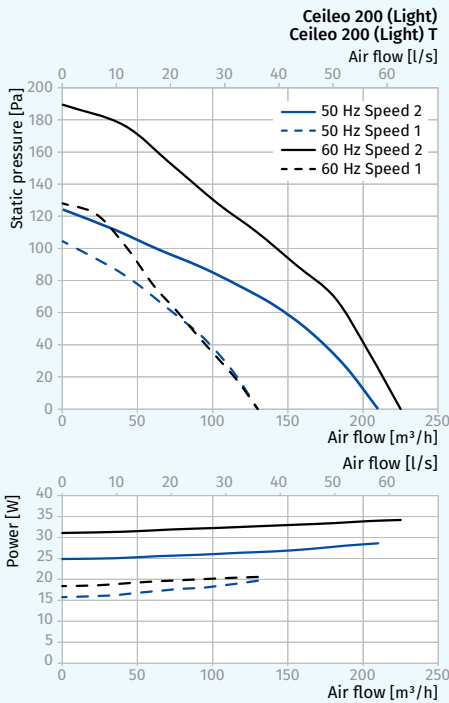









*** For fans with humidity or motion sensors



CEILEO

CENTRIFUGAL FANS

Accessories

Accessory name	Description	Ceileo 200 (Light) Ceileo 250 (Light)	Ceileo 300 (Light)	Ceileo 200 (Light) T Ceileo 250 (Light) T	Ceileo 300 (Light) T
CDP-2/10	 Speed switch	•	•	•	•
HS Ceileo	 Humidity sensor			•	•
IRS Ceileo	 Motion sensor			•	•
Decor S 102 HK	 Stainless steel ventilation hood Ø 100 mm	•		•	
Decor S 152 HK	 Stainless steel ventilation hood Ø 150 mm	•	•	•	•
Decor 155x155/100H	 Ventilation hood Ø 100 mm	•		•	
Decor 185x185/150H	 Ventilation hood Ø 150 mm	•	•	•	•
BlauFlex PVC/102/3	 Flexible air duct Ø 100 mm, 3 m long	•		•	
BlauFlex PVC/152/3	 Flexible air duct Ø 150 mm, 3 m long	•	•	•	•
K 100	 Quick-detachable stainless steel clamp Ø 90-110 mm	•		•	
K 150	 Quick-detachable stainless steel clamp Ø 140-160 mm	•	•	•	•
CH-PLC-10WG23	 10 W LED-light with colour temperature 3000 K (only for the Light models)	•	•	•	•

CEILEO DC

CENTRIFUGAL FANS

Centrifugal exhaust low noise and low watt fans for ceiling mounting



Air flow:
up to 254 m³/h
71 l/s



Power:
from 19 W

SFP:
from 0.37 W/l/s



Noise level:
from 23 dBA



Features



- Intermittent or continuous ventilation of bathrooms, showers, kitchens and other domestic spaces.
- For high-resistant ventilation systems.
- DC motor with low energy demand.
- Wide speed control range.
- Integrated LED-light with low energy demand (**Ceileo DC Light** models).
- The modular design enables easy retrofitting with the optional humidity and motion sensors (except for the basic model) or the grille with a light.
- Low noise level.
- Constant air flow.
- The centrifugal impeller has forward curved blades for high pressure and low noise.
- The motor impeller is made of high-quality durable ABS plastic.
- The fans also features a gravity backdraft damper.
- Ingress protection rating IPX4.
- Compatible with Ø 100 or 150 mm air ducts.

Motor

- The **Ceileo DC** fans feature high-efficient low power direct current motors with overheating protection.
- The constant air flow technology provides required air flow in a wide range of static pressure.

Design

- The casing is made of galvanized steel.
- The clip-on plastic grille ensures easy mounting and cleaning of the fan.
- The modular design enables easy retrofitting with the optional humidity and motion sensors (except for the basic model) or the grille with a light.



- **Ceileo DC Light** fans are both equipped with an energy efficient LED light.

Power: 10 W
Colour temperature:
3 000 K
Luminous flux:
650 lumens



Power: 60 W

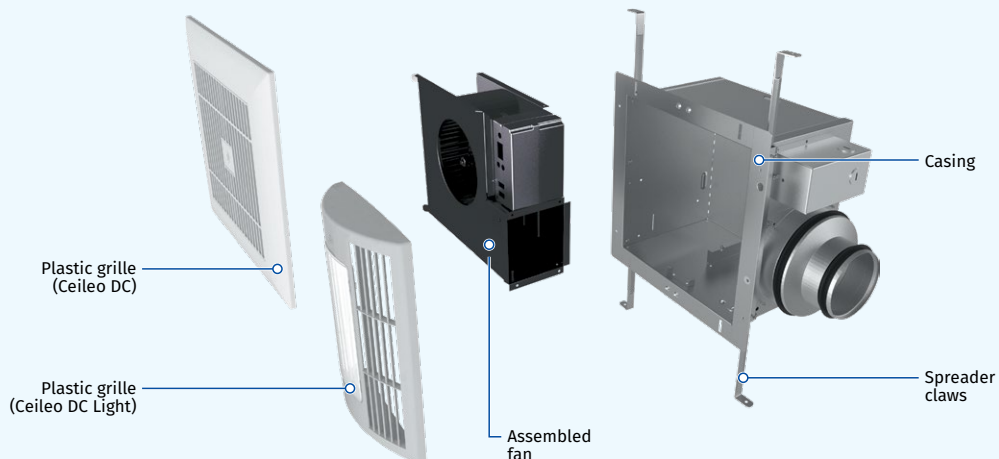

CEILEO DC

CENTRIFUGAL FANS

Options

Ceileo DC fans include an integrated turn-off delay timer. The fan can also be retrofitted with an optional humidity or motion sensor (available on a special order basis).

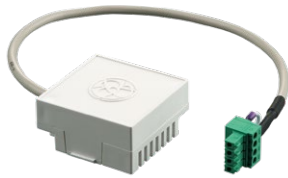

Humidity sensor

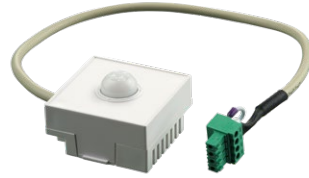

Motion sensor

Control

The built-in control panel of the **Ceileo DC** fans enables the following settings:

- turn-off delay
- humidity level
- air flow for modes 1 and 2

Name	Adjustment range for operation modes 1 and 2
Ceileo DC 110	Off / 100 / 120 / 135 / 155 / 170 / 190 m³/h
Ceileo DC 150	Off / 100 / 120 / 135 / 155 / 170 / 190 / 205 / 220 / 240 / 250 m³/h

Ceileo DC control panel



MANUAL CONTROL

The fan is controlled by means of the CDP-2/10 speed switch (available as a specially ordered accessory).



AUTOMATIC CONTROL



Timer: The fan is constantly set to the mode 1. The mode 2 is triggered by the light switch closing. Upon the light switch opening the built-in turn-off delay timer keeps the fan running in the mode 2 from 1 to 90 minutes. On elapsing of this period the fan reverts to the mode 1.



Timer and humidity sensor (available as a specially ordered accessory): the fan runs permanently in the mode 1. If the humidity level on the premises exceeds the sensor threshold value set in the 60-90 % range, the fan switches to the mode 2. When the humidity level reverts to the pre-set value, the built-in turn-off delay timer keeps the fan running in the mode 2 from 1 to 90 minutes. On elapsing of this period the fan reverts to the mode 1.



Timer and motion sensor (available as a specially ordered accessory): the fan runs permanently in the mode 1. If the motion sensor detects movement within its range, the fan goes to the mode 2. When the movement is no longer registered, the built-in turn-off delay timer keeps the fan running in the mode 2 from 1 to 90 minutes. On elapsing of this period the fan reverts to the mode 1.

Overall dimensions

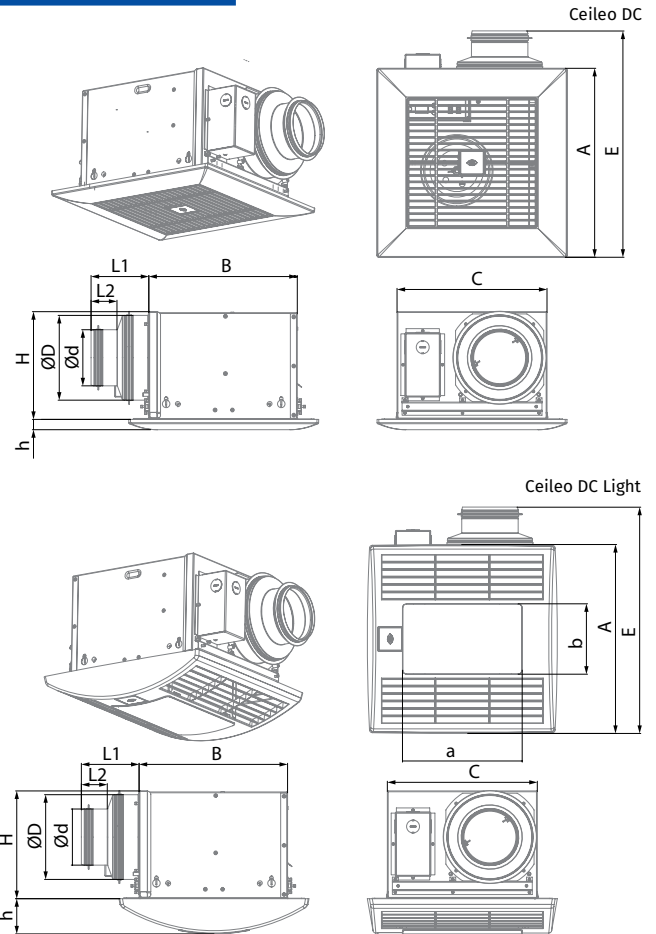

Dimensions [mm]	Ø D	Ø d	L1	L2	A	B	C	E	H	h	a	b
Ceileo DC 110	148	98	100	45	330	258	260	395	188	18	-	-
Ceileo DC 110 Light	148	98	100	45	330	258	260	395	188	62	208	123
Ceileo DC 150	149	-	50	-	330	258	260	395	188	18	-	-
Ceileo DC 150 Light	149	-	50	-	330	258	260	395	188	62	208	123

Mounting

- The fan is integrated into ceiling spaces.
- The fan is attached to the ceiling joists with spreader claws and self-tapping screws.
- The flexible air duct is attached to the fan exhaust spigot with a fixing clamp.



Designation key

Ceileo	DC	110	Light
Series	DC motor	Rated air flow [CFM]	LED-lamp available

CEILEO DC

CENTRIFUGAL FANS

Technical data

Model	Ceileo DC 110 Ceileo DC 110 Light	Ceileo DC 150 Ceileo DC 150 Light
Voltage [V/Hz]	120-240/50(60)	120-240/50(60)
Power [W]	19	26
LED-light power [W]**	2 x 10	2 x 10
RPM [min ⁻¹]	1100	1100
Current @ 230 V (120 V) [A]	0.18 (0.3)	0.24 (0.39)
Air flow [m ³ /h (l/s)]	187 (52)	254 (71)
SFP [W/l/s]	0.37	0.37
Sound pressure level [dBA]*	23-25	23-29
Weight [kg]	5.3 (6.4**)	5.1 (6.2**)
Ingress protection	IPX4	IPX4
SEC class***	B	B

* Sound pressure level measured in free space at a distance of 3 meters from the fan.

** Only for the Light model

*** For fans with humidity or motion sensors



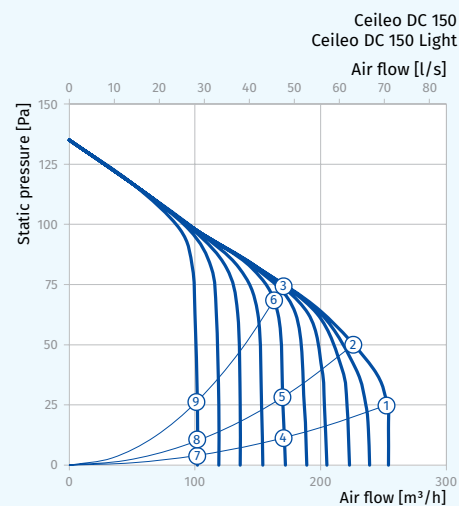
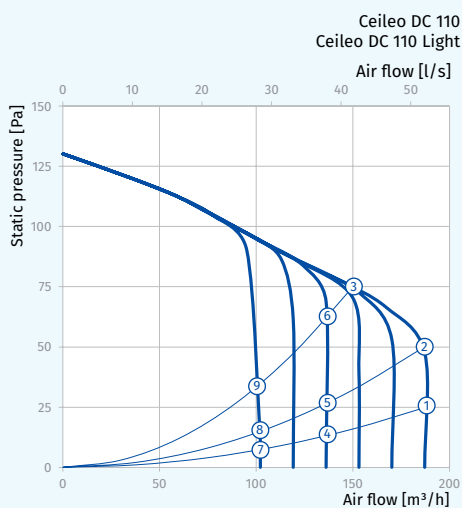









Point	Ceileo DC 110 Ceileo DC 110 Light	Ceileo DC 150 Ceileo DC 150 Light
1	17	24
2	19	22
3	16	19
4	9	13
5	12	15
6	15	17
7	4	5
8	4	5
9	6	6



CEILEO DC

CENTRIFUGAL FANS

Accessories

Accessory name	Description	Ceileo DC 110 Ceileo DC 110 Light	Ceileo DC 150 Ceileo DC 150 Light
CDP-2/10 	Speed switch	•	•
HS Ceileo 	Humidity sensor	•	•
IRS Ceileo 	Motion sensor	•	•
Decor S 102 HK 	Stainless steel ventilation hood Ø 100 mm	•	
Decor S 152 HK 	Stainless steel ventilation hood Ø 150 mm	•	•
Decor 155x155/100H 	Ventilation hood Ø 100 mm	•	
Decor 185x185/150H 	Ventilation hood Ø 150 mm	•	•
BlauFlex PVC/102/3 	Flexible air duct Ø 100 mm, 3 m long	•	
BlauFlex PVC/152/3 	Flexible air duct Ø 150 mm, 3 m long	•	•
K 100 	Quick-detachable stainless steel clamp Ø 90-110 mm	•	
K 150 	Quick-detachable stainless steel clamp Ø 140-160 mm	•	•
CH-PLC-10WG23 	10 W LED-light with colour temperature 3000 K (only for the Light models)	•	•

CEILEO COMPACT

CENTRIFUGAL FANS

Low profile exhaust fans with low noise and power consumption for ceiling mounting



Air flow:
up to 270 m³/h
75 l/s



Power:
from 20 W

SFP:
from 0.49 W/l/s



Noise level:
from 24 dBA



Features



- Intermittent or continuous ventilation of bathrooms, showers, kitchens and other domestic spaces.
- For high-resistant ventilation systems.
- Integrated LED light with low energy demand (**Ceileo Compact Light** models).
- The modular design enables easy connection of the optional humidity or motion sensors (not accessible for the basic model) or the grille with a LED light.
- Constant air flow.
- Low noise level.
- The centrifugal impeller has forward curved blades for high pressure and low noise.
- The fan's impeller is made of high-quality durable ABS plastic.
- The fans also are equipped with a gravity backdraft damper.
- Ingress protection rating IPX4.
- Compatible with Ø 100 mm air ducts.

Motor

- The **Ceileo Compact** fans are equipped with reliable asynchronous two-speed motors with overheating protection.
- The maintenance-free permanently lubricated motor bearings are engineered for over 40 000 operating hours of trouble-free operation.

Design

- The casing is made of galvanized steel.
- The clip-on plastic grille ensures easy mounting and cleaning of the fan.
- The modular design of the grille enables easy retrofitting with the optional humidity or motion sensors.



- **Ceileo Compact Light** fans are equipped with an energy efficient LED light.

Power: 10 W
Colour temperature:
3 000 K
Luminous flux:
650 lumens



Power: 60 W

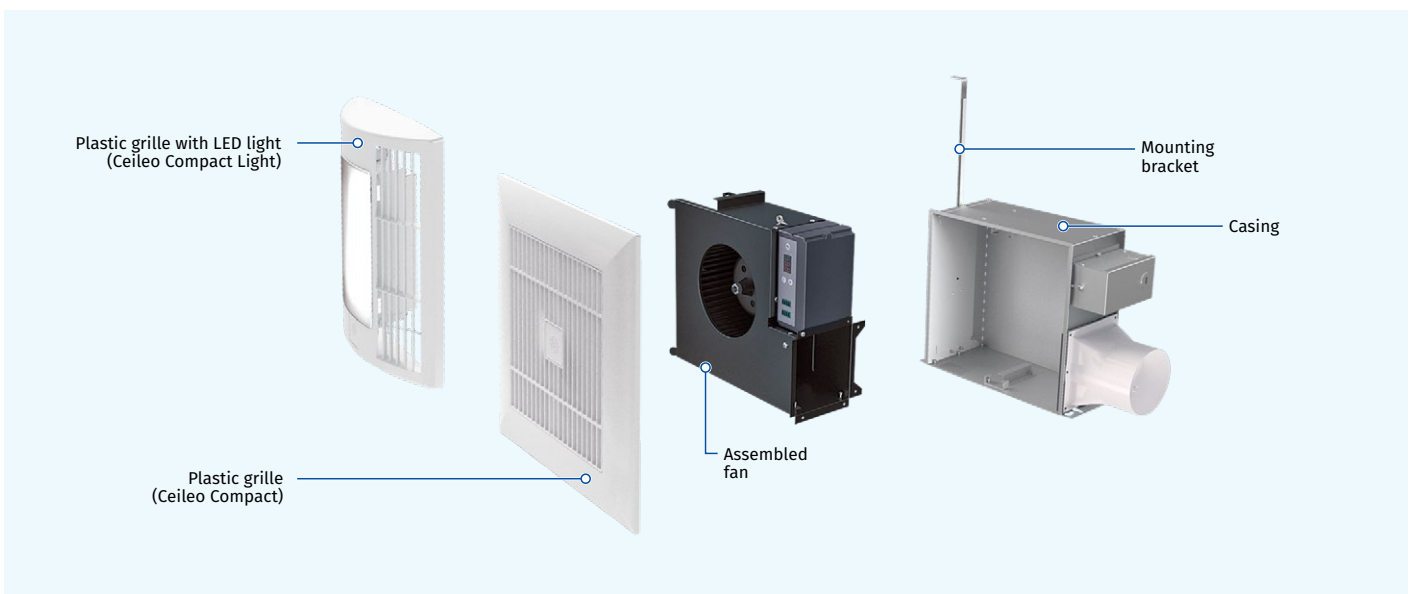

CEILEO COMPACT

CENTRIFUGAL FANS

Options

Ceileo Compact: Double-speed basic fan model.

Ceileo Compact T: Models with an adjustable turn-on and turn-off delay timer. This model can also be retrofitted with an optional humidity or motion sensor (available on a special order basis).

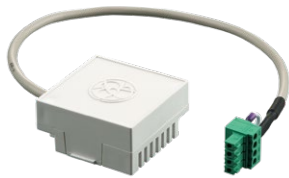

Humidity sensor

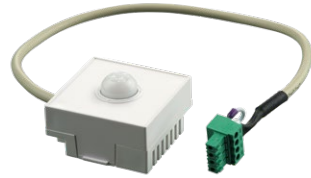

Motion sensor

Control

The built-in control panel of the **Ceileo Compact T** fans enables the following settings:

- turn-on delay by timer
- turn-off delay by timer
- humidity level
- air flow for the operating modes 1 and 2

Name	Adjustment range for operation modes 1 and 2
Ceileo Compact 200 T	Off / Speed 1/Speed 2
Ceileo Compact 250 T	Off / Speed 1/Speed 2

Ceileo Compact T control panel



MANUAL CONTROL

The fan is controlled by means of the CDP-2/10 speed switch (available as a specially ordered accessory).



AUTOMATIC CONTROL



Timer: The fan is continuously running in the mode 1. Upon the light switch closing, the fan goes to mode 2 after the turn-on delay timer countdown (from 0 to 3 minutes). Upon the light switch is turned off the built-in turn-off delay timer keeps the fan running in the mode 2 from 1 to 90 minutes. On elapsing of this period the fan reverts to the mode 1.



Timer and humidity sensor (available as a specially ordered accessory): the fan runs continuously in the mode 1. If the indoor humidity level exceeds the sensor threshold value set in the 50-90 % range, the fan switches to the mode 2. When the humidity level reverts to the pre-set value, the built-in turn-off delay timer keeps the fan running in the mode 2 from 1 to 90 minutes. On elapsing of this period the fan reverts to the mode 1.



Timer and motion sensor (available as a specially ordered accessory): the fan runs continuously in the mode 1. If the motion sensor detects movement within its operation zone, the fan goes to the mode 2. When the movement is no longer registered, the built-in turn-off delay timer keeps the fan running in the mode 2 from 1 to 90 minutes. On elapsing of this period the fan reverts to the mode 1.

Overall dimensions

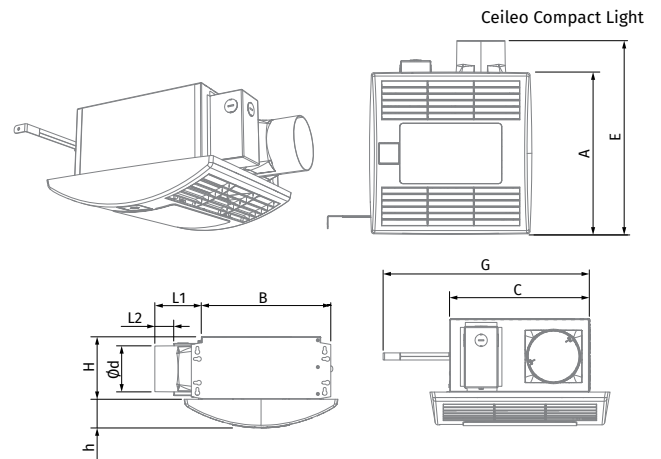
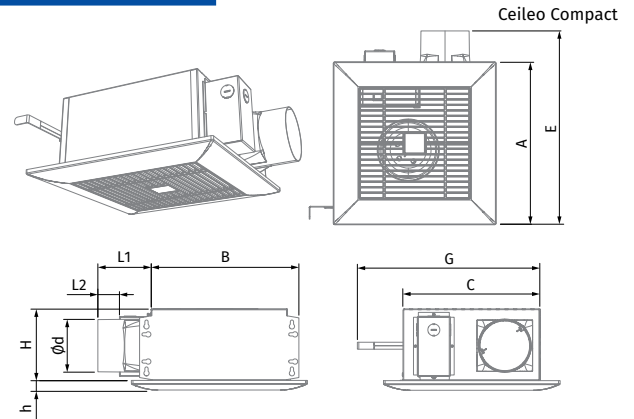

Dimensions [mm]	Ø d	L1	L2	A	B	C	E	H	h	G
Ceileo Compact 200/250	98	100	40.5	330	278	255	395	134	18	max 620
Ceileo Compact 200/250 Light	98	100	40.5	330	278	255	395	134	57	max 620

Mounting

- The fan is integrated into ceiling spaces.
- The fan is attached to the ceiling joists with a mounting bracket and self-tapping screws.
- The flexible air duct is attached to the fan exhaust spigot with a fixing clamp.
- Reduced casing height allows installing fans in ceilings with a thickness from 140 mm.



Designation key

Ceileo Compact	200	Light	T
Series	Rated air flow [CFM]	LED-lamp available	Option

CEILEO COMPACT

CENTRIFUGAL FANS

Technical data

Model	Ceileo Compact 200 (Light) Ceileo Compact 200 (Light) T				Ceileo Compact 250 (Light) Ceileo Compact 250 (Light) T			
	min	max	min	max	min	max	min	max
Voltage [V/Hz]	220-240/50		220-240/60		220-240/50		220-240/60	
Power [W]	20	29	21	34	23	39	25	50
LED-light power [W]**	2 × 10				2 × 10			
RPM [min ⁻¹]	714	1026	588	936	756	1122	732	1140
Current [A]	0.1	0.13	0.11	0.15	0.12	0.18	0.14	0.22
Air flow [m ³ /h (l/s)]	130 (36)	210 (58)	130 (36)	225 (63)	170 (47)	260 (72)	160 (44)	270 (75)
SFP [W/l/s]	0.55	0.50	0.58	0.54	0.49	0.54	0.56	0.67
Sound pressure level [dBA]*	24	27	24	28	25	29	25	30
Weight [kg]	5.3 (6.4**)				5.3 (6.4**)			
Ingress protection	IPX4				IPX4			
SEC class***	C				C			

* Sound pressure level measured in free space at a distance of 3 meters from the fan.

** Only for the Light model

*** For fans with humidity or motion sensors

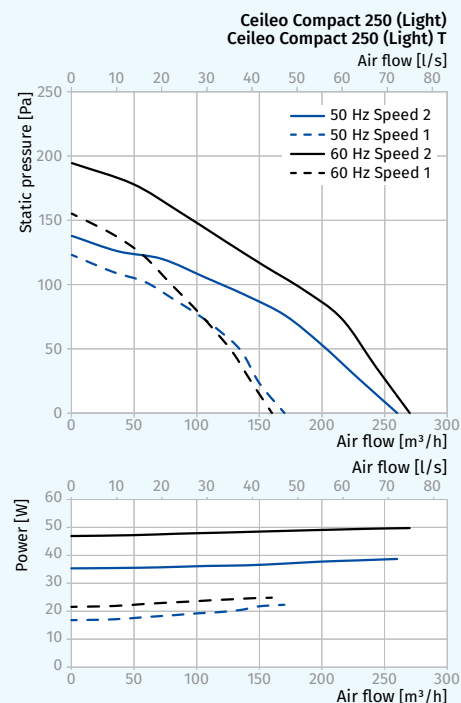
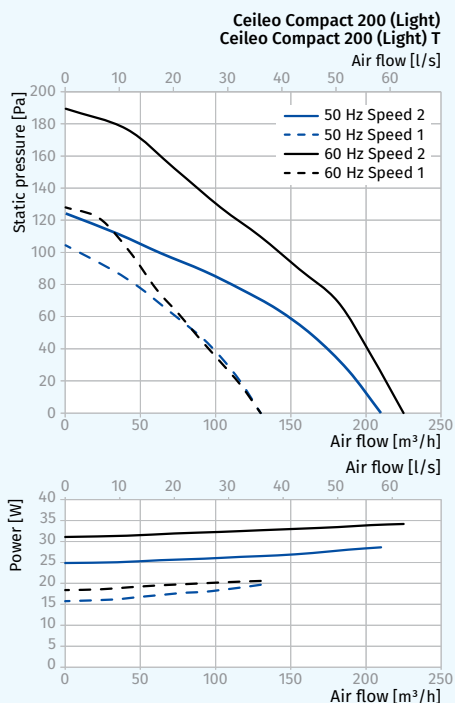

ENERG Y UA
 енергия · ενεργεια IE IA

BLAUBERG Ceileo Compact 250 H

A+

A

B

C

D

E

F

G

C

48
dB









120 m³/h

ENERGIJA · ΕΝΕΡΓΙΑ · ENERGIJA · ENERGIJA · ENERGIJA · ENERGIJA · ENERGIJA
 2021 1254/2014

CEILEO COMPACT

CENTRIFUGAL FANS

Accessories

Accessory name	Description	Ceileo Compact 200 (Light) Ceileo Compact 250 (Light)	Ceileo Compact 200 (Light) T Ceileo Compact 250 (Light) T
CDP-2/10	 Speed switch	•	•
HS Ceileo	 Humidity sensor		•
IRS Ceileo	 Motion sensor		•
Decor S 102 HK	 Stainless steel outer ventilation hood Ø 100 mm	•	•
Decor 155x155/100H	 Outer ventilation hood Ø 100 mm	•	•
BlauFlex PVC/102/3	 Flexible air duct Ø 100 mm, 3 m long	•	•
K 100	 Quick-detachable stainless steel clamp Ø 90-110 mm	•	•
CH-PLC-10WG23	 10 W LED-light with colour temperature 3000 K (only for the Light models)	•	•

CEILEO COMPACT DC

CENTRIFUGAL FANS

Low profile exhaust fans with low noise and power consumption for ceiling mounting



Air flow:
up to 187 m³/h
52 l/s



Power:
from 19 W
SFP:
from 0.37 W/l/s



Noise level:
from 23 dBA



Features



- Intermittent or continuous ventilation of bathrooms, showers, kitchens and other domestic spaces.
- For high-resistant ventilation systems.
- Integrated LED-light with low energy demand (**Ceileo Compact DC Light** models).
- The modular design enables easy connection of the optional humidity or motion sensors or the grille with a LED light.
- Constant air flow.
- Low noise level.
- The centrifugal impeller has forward curved blades for high pressure and low noise.
- The fan's impeller is made of high-quality durable ABS plastic.
- The fans also are equipped with a gravity backdraft damper.
- Ingress protection rating IPX4.
- Compatible with Ø 100 mm air ducts.

Motor

- The **Ceileo Compact DC** fan is equipped with a high efficient DC motor with low power consumption and electronic overheating protection. Constant air flow technology provides the necessary performance in a wide range of static pressure.

Design

- The casing is made of galvanized steel.
- The clip-on plastic grille ensures easy mounting and cleaning of the fan.
- The modular design of the grille enables easy retrofitting with the optional humidity or motion sensors.



- **Ceileo Compact DC Light** fans are equipped with an energy efficient LED light.

Power: 10 W
Colour temperature:
3 000 K
Luminous flux:
650 lumens



Power: 60 W

Plastic grille with LED light
(Ceileo Compact DC Light)

Plastic grille
(Ceileo Compact DC)



Assembled fan

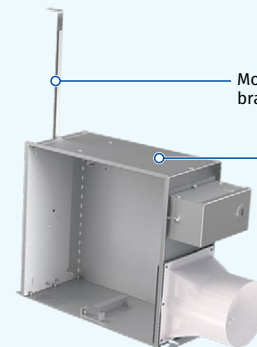

Mounting bracket

Casing

CEILEO COMPACT DC

CENTRIFUGAL FANS

Options

Ceileo Compact DC: Models with an adjustable turn-off and turn-on delay timer.
This model can also be retrofitted with an optional humidity or motion sensor (available on a special order basis).

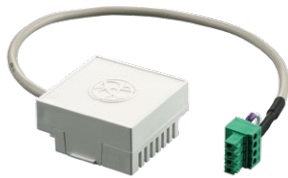

Humidity sensor

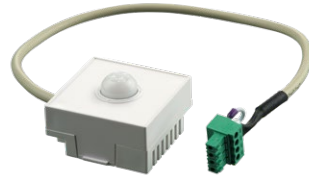

Motion sensor

Control

The built-in control panel of the **Ceileo Compact DC** fans enables the following settings:

- turn-on delay by timer
- turn-off delay by timer
- humidity level
- air flow for operating modes 1 and 2

Name	Adjustment range for operation modes 1 and 2
Ceileo Compact DC 110	Off / 100 / 120 / 135 / 155 / 170 / 190 m ³ /h

Ceileo Compact DC control panel



MANUAL CONTROL

The fan is controlled by means of the CDP-2/10 speed switch (available as a specially ordered accessory).



AUTOMATIC CONTROL



Timer: The fan is continuously running in the mode 1. Upon the light switch closing, the fan goes to mode 2 after the turn-on delay timer countdown (from 0 to 3 minutes). Upon the light switch is turned off the built-in turn-off delay timer keeps the fan running in the mode 2 from 1 to 90 minutes. On elapsing of this period the fan reverts to the mode 1.



Timer and humidity sensor (available as a specially ordered accessory): the fan runs continuously in the mode 1. If the indoor humidity level exceeds the sensor threshold value set in the 50-90 % range, the fan switches to the mode 2. When the humidity level reverts to the pre-set value, the built-in turn-off delay timer keeps the fan running in the mode 2 from 1 to 90 minutes. On elapsing of this period the fan reverts to the mode 1.



Timer and motion sensor (available as a specially ordered accessory): the fan runs continuously in the mode 1. If the motion sensor detects movement within its operation zone, the fan goes to the mode 2. When the movement is no longer registered, the built-in turn-off delay timer keeps the fan running in the mode 2 from 1 to 90 minutes. On elapsing of this period the fan reverts to the mode 1.

Overall dimensions

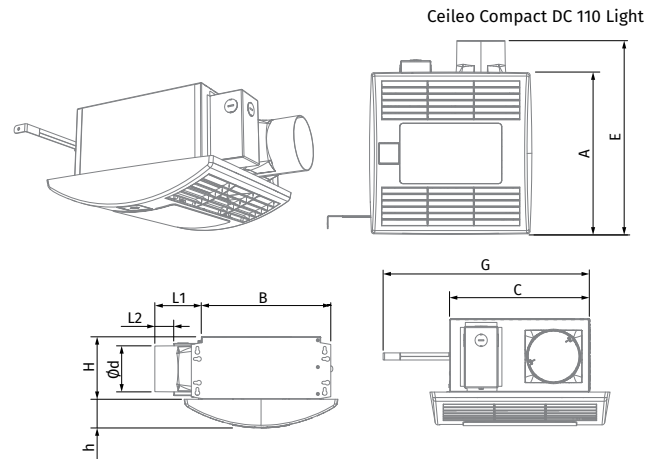
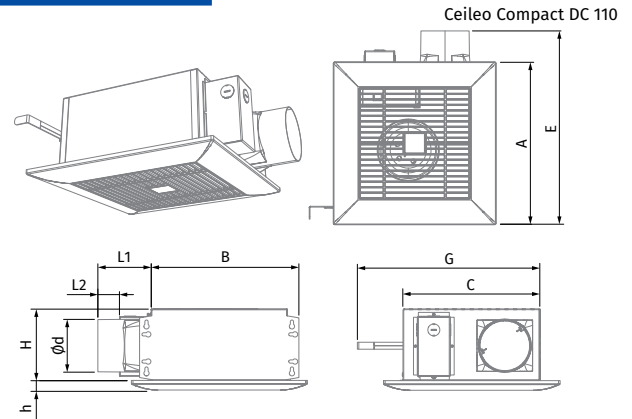

Dimensions [mm]	Ø d	L1	L2	A	B	C	E	H	h	G
Ceileo Compact DC 110	98	100	40.5	330	278	255	395	134	18	max 620
Ceileo Compact DC 110 Light	98	100	40.5	330	278	255	395	134	57	max 620

Mounting

- The fan is integrated into ceiling spaces.
- The fan is attached to the ceiling joists with a mounting bracket and self-tapping screws.
- The flexible air duct is attached to the fan exhaust spigot with a fixing clamp.
- Reduced casing height allows installing fans in ceilings with a thickness from 140 mm.



Designation key			
Ceileo Compact	DC	110	Light
Series	DC motor	Rated air flow [CFM]	LED-lamp available

CEILEO COMPACT DC

CENTRIFUGAL FANS

Technical data

Model	Ceileo Compact DC 110 Ceileo Compact DC 110 Light
Voltage [V/Hz]	120-240/50(60)
Speed	-
Power [W]	19
LED-light power [W]**	2 × 10
RPM [min ⁻¹]	1100
Current [A]	0.18
Air flow [m ³ /h (l/s)]	187 (52)
SFP [W/l/s]	0.37
Sound pressure level [dBA]*	from 23 to 25
Weight [kg]	5.3 (6.4**)
Ingress protection	IPX4
SEC class***	C

* Sound pressure level measured in free space at a distance of 3 meters from the fan.

** Only for the Light model

*** For fans with humidity or motion sensors



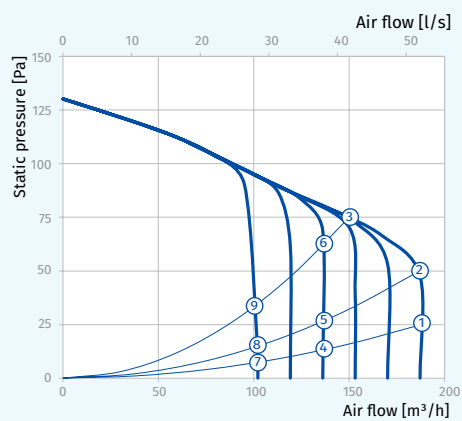





Point	Power [W]
1	17
2	19
3	16
4	9
5	12
6	15
7	4
8	4
9	6



CEILEO COMPACT DC

CENTRIFUGAL FANS

Accessories

Accessory name		Description	Ceileo Compact DC 110 (Light)
CDP-2/10		Speed switch	•
HS Ceileo		Humidity sensor	•
IRS Ceileo		Motion sensor	•
Decor S 102 HK		Stainless steel outer ventilation hood Ø 100 mm	•
Decor 155x155/100H		Outer ventilation hood Ø 100 mm	•
BlauFlex PVC/102/3		Flexible air duct Ø 100 mm, 3 m long	•
K 100		Quick-detachable stainless steel clamp Ø 90-110 mm	•
CH-PLC-10WG23		10 W LED-light with colour temperature 3000 K (only for the Light models)	•

VALEO

CENTRIFUGAL FANS

Use

- Exhaust ventilation systems installed in high-rise buildings and premises.
- For buildings with a mono-pipe ventilation system.
- For mounting in kitchens and bathrooms.
- Installation in a casing for flush or surface mounting.



Air flow:
up to 100 m³/h
28 l/s



Power:
from 15 W
SFP:
from 1.04 W/l/s



Noise level:
from 27 dBA



Design

- The Valeo ventilation unit is designed for installation in a plastic or fire-proof casing.
- The front panel is made of snow-white UV-resistant plastic.
- Filter with filter class G4 for motor, impeller and ductwork system protection against soiling.
- The filter is easily accessible for service operations.
- The ventilation unit with the motor is fixed inside the casing with special latches.
- Due to modern design and various colour modifications the front panel matches well with any interior.

Motor

- Two-speed motor with a centrifugal impeller. Minimum energy demand.
- The impeller has forward curved blades.
- Automatic maintaining of constant air flow depending on variable air resistance of the duct.
- Balanced impeller ensures low noise operation.
- Best aerodynamic characteristics due to a special scroll casing design.
- Ball bearings provide long service life.

Speed control

- Step speed control with an external speed controller, e.g. a CDP-3/5 model which is available upon order.
- Wide range of system controls with programmable parameters (timer, adjustable timer, internal switch, photo sensor, humidity sensor).

Options

- Timer (Valeo...T)**
Depending on wiring connection the fan is off or runs permanently at low speed. The fan is turned to higher speed with an external switch 50 s after activation. After turning the switch off the fan continues operating within 6 min at higher speed and then reverts to the default operation mode.
- Adjustable timer (Valeo...TR)**
Depending on wiring connection the fan is off or runs permanently at low speed. If the fan is turned on with an external switch, it switches to higher speed 0 to 150 s after switch activation. After turning the fan off it continues running at higher speed within 2 to 30 minutes and then reverts to the previous mode. The fan run-out time and delay time for higher speed are regulated with the internal regulator.
- Interval switch (Valeo...I)**
Depending on wiring connection the fan is off or runs permanently at low speed. In interval mode regulated from 0.5 to 15 hours the fan switches periodically to higher speed for 10 minutes. The switch interval is adjusted with the internal regulator. If the light in the room is turned on, the fan switches to higher speed in 50 s. After light is off the fan reverts to the interval mode operation.
- Humidity sensor (Valeo...H)**
Depending on wiring connection the fan is off or runs permanently at low speed. The fan switches to higher speed as relative humidity in the room increases from 60 % up to 90 % and switches off as humidity drops by 10 % below the set level. If the light in the room is turned on, the fan switches to higher speed in 50 s. The run-out time is set by the internal regulator from 2 to 30 minutes.

Designation key

Valeo	35/60	TR
Model	Air flow according to speed	Option

Accessories

Filter	Flexible air duct	Speed controller	Clamp
			
FP-Valeo	BlauFlex AN	CDP-2/5	K

VALEO

CENTRIFUGAL FANS

Plastic mounting casing

- o BP 80: plastic casing for flush mounting.
- o Made of quality ABS plastic and equipped with a gravity backdraft damper.
- o Installed in a wall or ceiling during general construction works by mounting brackets supplied as a standard.
- o The casing is equipped with oblong slotted joints to facilitate mounting.
- o Connection to the main ventilation shaft with flexible air ducts.
- o Exhaust spigot diameter 80 mm.
- o After installation works cover the unit with a protecting cover to prevent dirt ingress.
- o After finishing works install the Valeo unit inside the casing.
- o For exhaust ventilation of neighbour rooms additional spigots may be connected to the casing.



Gravity backdraft damper

Mounting example

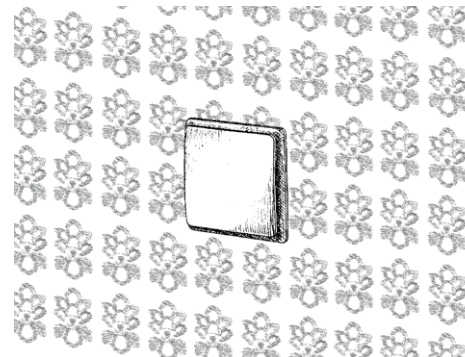
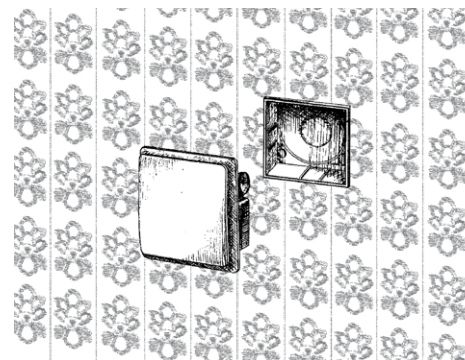
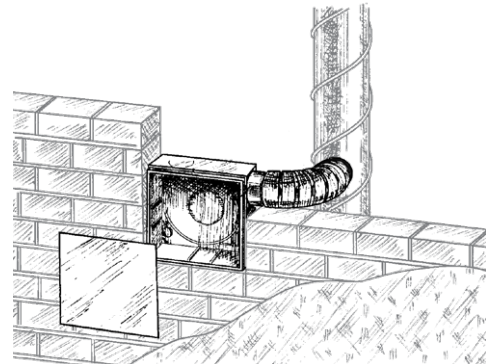

VALEO

CENTRIFUGAL FANS

Mounting fireproof casing

- **BF 80**: fireproof casing for flush mounting.
- Made of silicate plates based on calcium silicate and has high thermal insulating properties.
- Equipped with a fire-retarding damper to prevent fire and smoke expanding along air ducts. If temperature in the duct reaches 90°C the thermal fuse closes the damper.
- When the fan is off, the fire-retarding damper serves as a backdraft damper.
- The fan casing is installed in a wall or ceiling during general construction works by mounting brackets supplied as a standard.
- Connection to the main ventilation shaft with flexible air ducts. Exhaust spigot diameter 80 mm.
- Power is supplied to the fan through a sealed electric lead-in on the casing.
- After installation works cover the unit with a protecting cover to prevent dirt ingress.
- After finishing works install the ventilation unit inside the casing and connect it to the wiring system.
- For exhaust ventilation of neighbour rooms extra spigots may be connected to the casing on the left (**BFL** modification), on the right (**BFR** modification), on the bottom (**BFD** modification).



Mounting example

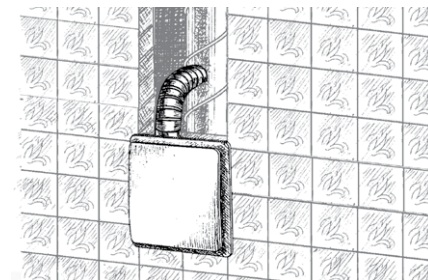
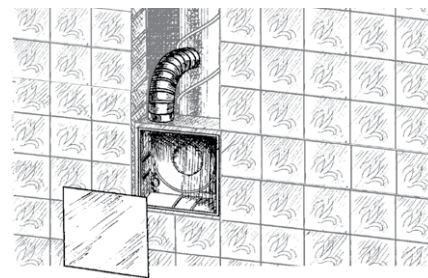
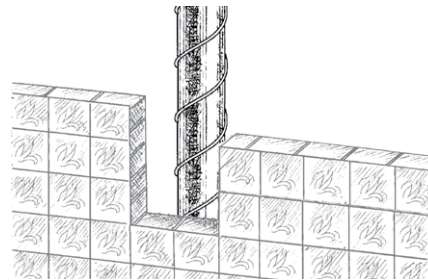

BFL 80



BFR 80



Fire-retarding damper



BFD 80

Overall dimensions [mm]

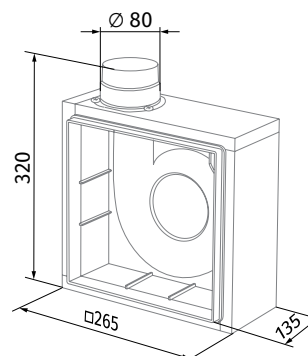
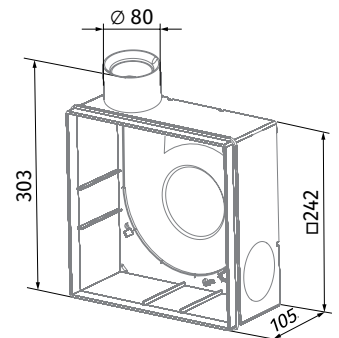
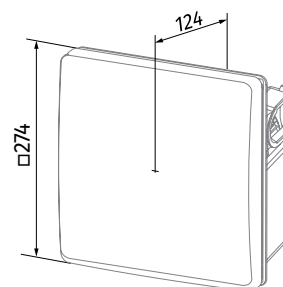

VALEO

CENTRIFUGAL FANS

Technical data

Model	Valeo 35/60	Valeo 75/100
Speed	I / II	I / II
Voltage [V/Hz]	220-240/50	220-240/50
Power [W]	15 / 25	24 / 29
Current [A]	0.12 / 0.14	0.11 / 0.13
Cable cross section [mm ²]	3x1.5	3x1.5
Maximum air flow [m ³ /h (l/s)]	35 (10) / 63 (18)	75 (21) / 100 (28)
Sound pressure level [dBA]*	27 / 36	29 / 38
Max. transported air temperature [°C]	+50	+50
IP rating	IP55	IP55

* Sound pressure level measured in free space at a distance of 3 meters from the fan.

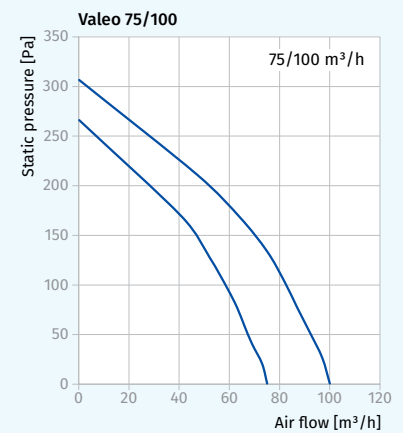
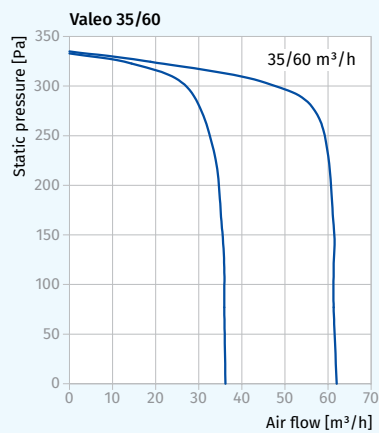

- The abrupt curves show high pressure performance and constant air flow of several **Valeo** fans integrated into a single ventilation shaft.

VALEO

CENTRIFUGAL FANS

Calculation of basic ventilation shaft diameter for mono-pipe ventilation systems

- The charts below display dependence of ventilation shaft dimensions as a function of number of storeys in high-rise buildings with a mono-pipe ventilation system.

VENTILATION OF BATHROOMS OR TOILETS AT THE CALCULATED AIR FLOW RATE OF 60 M³/H

- One fan per each floor, rated air flow 60 m³/h for full operation mode of all fans.

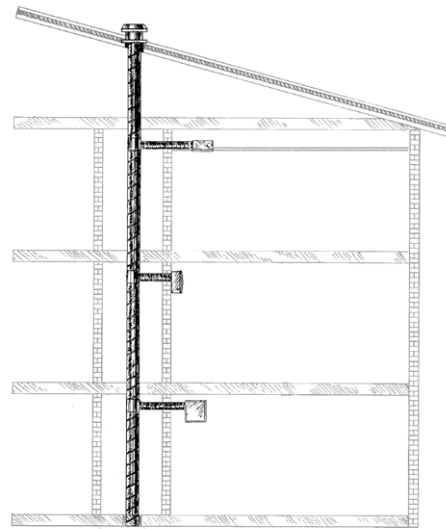
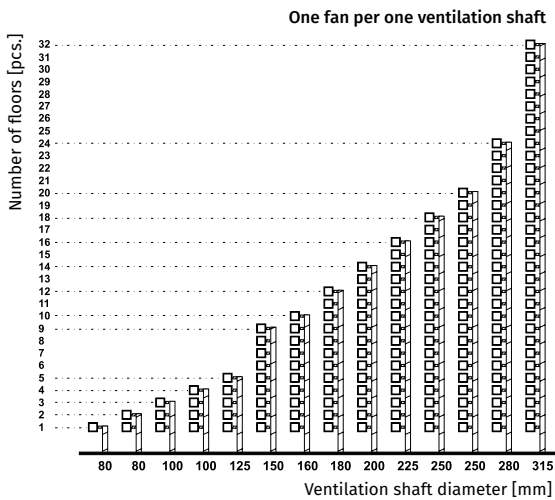

- Two fans per each floor, rated air flow 60 m³/h for full operation mode of all the fans.

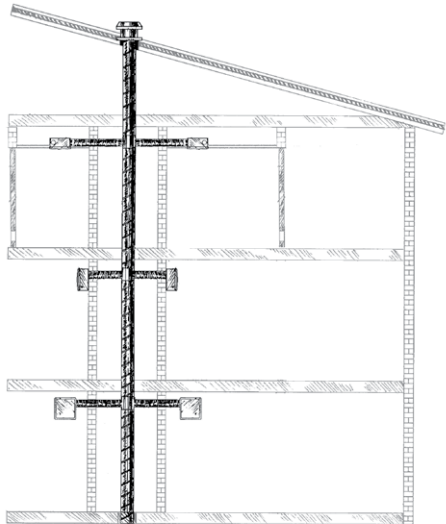
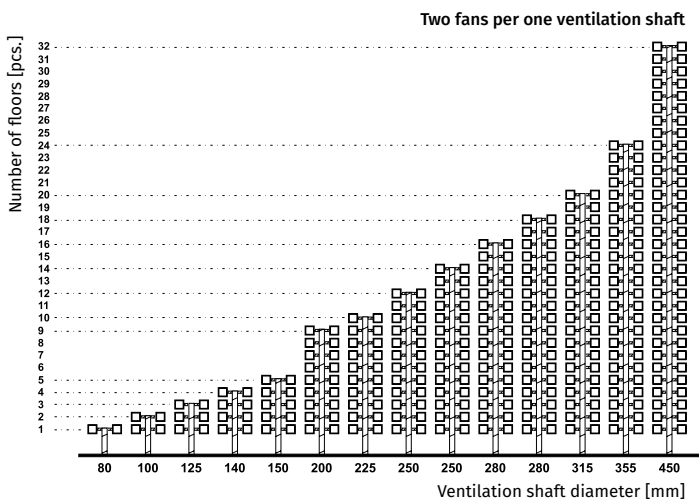

VALEO

CENTRIFUGAL FANS

Calculation of basic ventilation shaft diameter for mono-pipe ventilation systems

- The charts below display dependence of ventilation shaft dimensions as a function of number of storeys in high-rise buildings with a mono-pipe ventilation system.

VENTILATION OF KITCHENS OR SIMULTANEOUS VENTILATION OF TWO SPACES AT THE CALCULATED AIR FLOW RATE OF 100 M³/H

- One fan per each floor, rated air flow for kitchen 100 m³/h for full operation mode of all fans.
- For synchronous room-to-room ventilation: 60 m³/h for bathroom and 40 m³/h for WC.

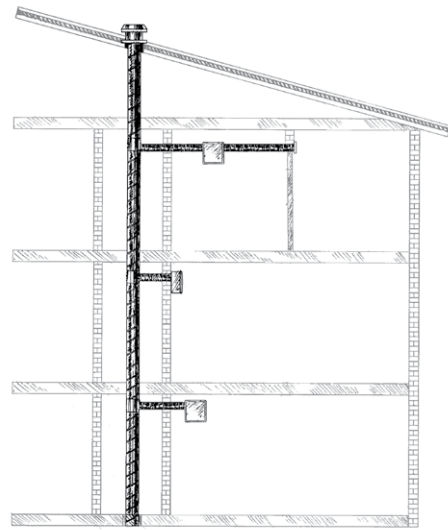
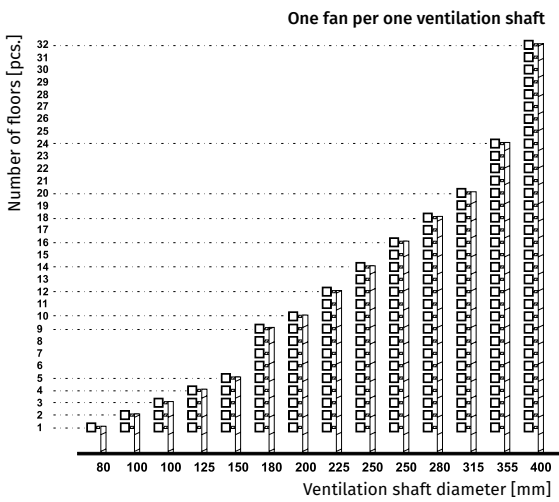

- Two fans per each floor, rated air flow for kitchen 100 m³/h for full operation mode of all the fans.
- For synchronous room-to-room ventilation: 60 m³/h for bathroom and 40 m³/h for WC.

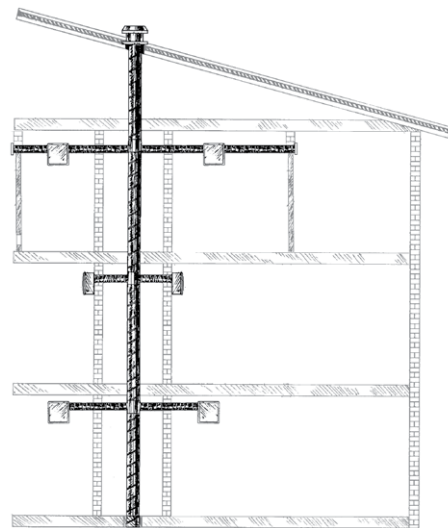
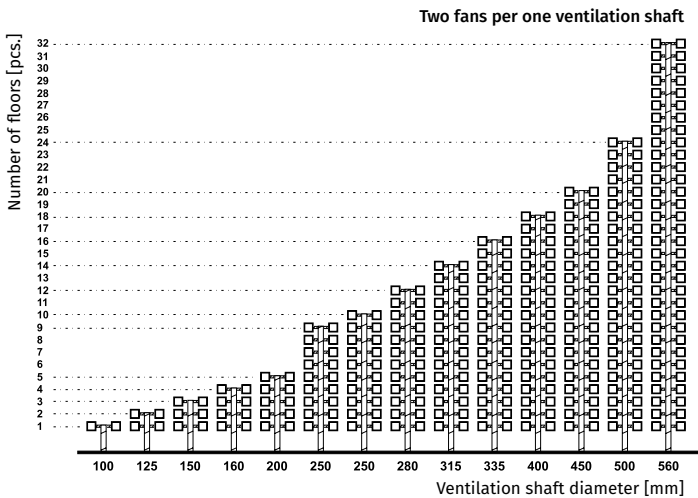

VALEO-BP

CENTRIFUGAL FANS

Use

- Exhaust ventilation systems installed in high-rise buildings and premises.
- Mono-pipe ventilation systems.
- For mounting in kitchens and bathrooms.
- Flush wall or ceiling mounting.



Air flow:
up to 100 m³/h
28 l/s



Power:
from 15 W
SFP:
from 1.04 W/l/s



Noise level:
from 27 dBA



Design

- The fan consists of the plastic casing **BP** for flush mounting and exhaust ventilation unit **Valeo** with a flat front panel.
- The casing is made of durable ABS plastic and fitted with a gravity back-draft damper to prevent backdraft.



- The front panel is made of snow white UV-resistant plastic.
- G4 purifying durable filter protects the motor, impeller and ductwork system against soiling.
- The filter is easily accessible for service operations.
- Due to modern design and various colour modifications the front panel matches well with any interior.
- The casing is equipped with oblong slotted joints to facilitate mounting of the casing in true vertical position.
- If the casing is installed with some vertical deviations, the special turnable grille conceals possible mounting inaccuracies.
- Power is supplied to the fan through a sealed electric lead-in on the casing and the ventilation unit is equipped with an airtight terminal block for connection to the wiring system.
- For room-to-room ventilation some ventilation unit modifications are equipped with extra spigots: **Valeo-BPL** – on the left; **Valeo-BPR** – on the right; **Valeo-BPD** – on the bottom.
- Ingress protection rating IP55.

Motor

- Two-speed motor with a centrifugal impeller. Minimum energy demand.
- The impeller has forward curved blades.
- Automatic maintaining of constant air flow depending on variable air resistance of the duct.
- Balanced impeller ensures low noise operation.
- Best aerodynamic characteristics due to a special scroll casing design.
- Ball bearings provide long service life.
- The ventilation unit with the motor is fixed inside the casing with special latches.

Speed control

- Step speed control with an external speed controller, e.g. a **CDP-3/5** model which is available upon order.
- Wide range of intellectual controls programmable by set parameters (timer, adjustable timer, internal switch, photo sensor, humidity sensor).

Designation key

Valeo-BP	35/60	TR
Model	Air flow according to speed	Option

Accessories

Filter	Flexible air duct	Speed controller	Clamp
 FP-Valeo	 BlauFlex AN	 CDP-2/5	 K

VALEO-BP

CENTRIFUGAL FANS

Options

o **Timer (Valeo-BP..T)**

Depending on wiring connection the fan is off or runs permanently at low speed. The fan is turned to higher speed with an external switch 50 s after activation. After turning the switch off the fan continues operating within 6 min at higher speed and then reverts to default operation mode.

o **Adjustable timer (Valeo-BP..TR)**

Depending on wiring connection the fan is off or runs permanently at low speed. If the fan is turned on with an external switch, it switches to higher speed 0 to 150 s after switch activation. After turning the fan off it continues running at higher speed within 2 to 30 minutes and then reverts to the previous mode. The fan run-out time and delay time for higher speed are regulated with the internal regulator.

o **Interval switch (Valeo-BP..I)**

Depending on wiring connection the fan is off or runs permanently at low speed. In interval mode regulated from 0.5 to 15 hours the fan switches periodically to higher speed for 10 minutes. The switch interval is adjusted with the internal regulator. If the light in the room is turned with the external switch, the fan switches to higher speed in 50 s. After light is off the fan reverts to the interval mode operation.

o **Humidity sensor (Valeo-BP..H)**

Depending on wiring connection the fan is off or runs permanently at low speed. The fan switches to higher speed as relative humidity in the room increases from 60 % up to 90 % and switches off as humidity drops by 10 % below the set level. If the light in the room is turned on, the fan switches to higher speed in 50 s. The run-out time is set by the internal regulator from 2 to 30 minutes.

Mounting

- o Installed in a wall or ceiling during general construction works by mounting brackets supplied as a standard.
- o Connection to the main ventilation shaft with flexible air ducts.
- o For exhaust ventilation of a neighbour room remove a plug and install an additional spigot. Available upon separate order.
- o Exhaust spigot diameter 80 mm.
- o Power is supplied to the fan through a sealed electric lead-in on the casing.
- o After installation works cover the unit with a protecting cover to prevent dirt ingress.
- o After finishing works install the ventilation unit inside the casing and connect it to the wiring system.

Mounting example

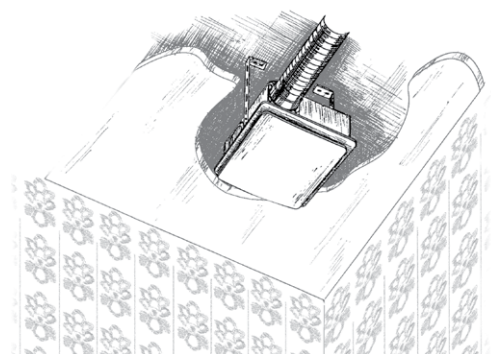

Overall dimensions [mm]

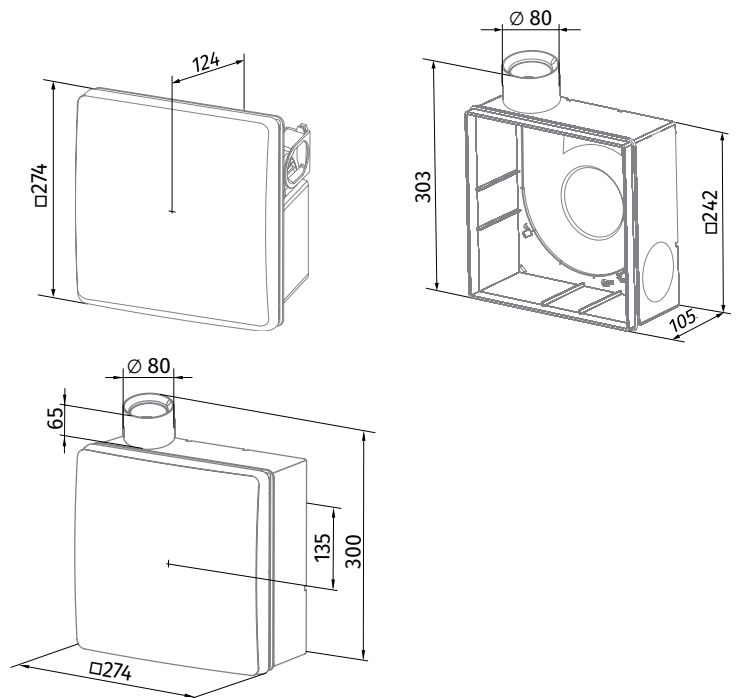

VALEO-BP

CENTRIFUGAL FANS

Technical data

Model	Valeo-BP 35/60	Valeo-BP 75/100
Speed	I / II	I / II
Voltage [V/Hz]	220-240/50	220-240/50
Power [W]	15 / 25	24 / 29
Current [A]	0.12 / 0.14	0.11 / 0.13
Cable cross section [mm ²]	3x1.5	3x1.5
Maximum air flow [m ³ /h (l/s)]	35 (10) / 63 (18)	75 (21) / 100 (28)
Sound pressure level [dBA]*	27 / 36	29 / 38
Max. transported air temperature [°C]	+50	+50
IP rating	IP55	IP55

* Sound pressure level measured in free space at a distance of 3 meters from the fan.

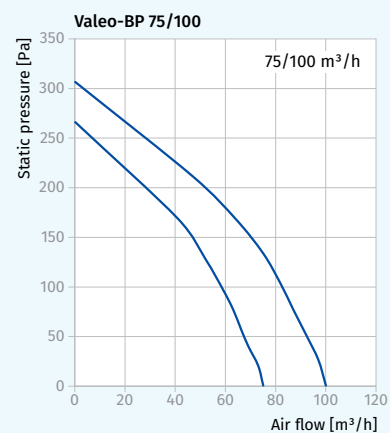
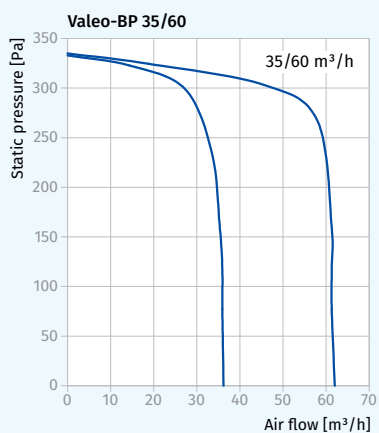

- The abrupt curves show high pressure performance and constant air flow of several **Valeo-BP** fans integrated into a single ventilation shaft.

VALEO-BP

CENTRIFUGAL FANS

High-rise mono-pipe ventilation system arrangement example

- The mechanical centralized mono-pipe exhaust ventilation system for kitchens and bathrooms based on Valeo-BP fans is specially designed for high-rise residential premises.
- Fresh air is supplied to bedrooms, children's room or living rooms through windows or wall vents. Vent modifications with air volume regulation are available.

- Stale air is extracted from the room by the exhaust fans through the inside doors or door grilles in the kitchen, bathroom or WC.
- This ventilation system arrangement ensures non-stop controllable air circulation in the room, comfortable microclimate and high fire safety.

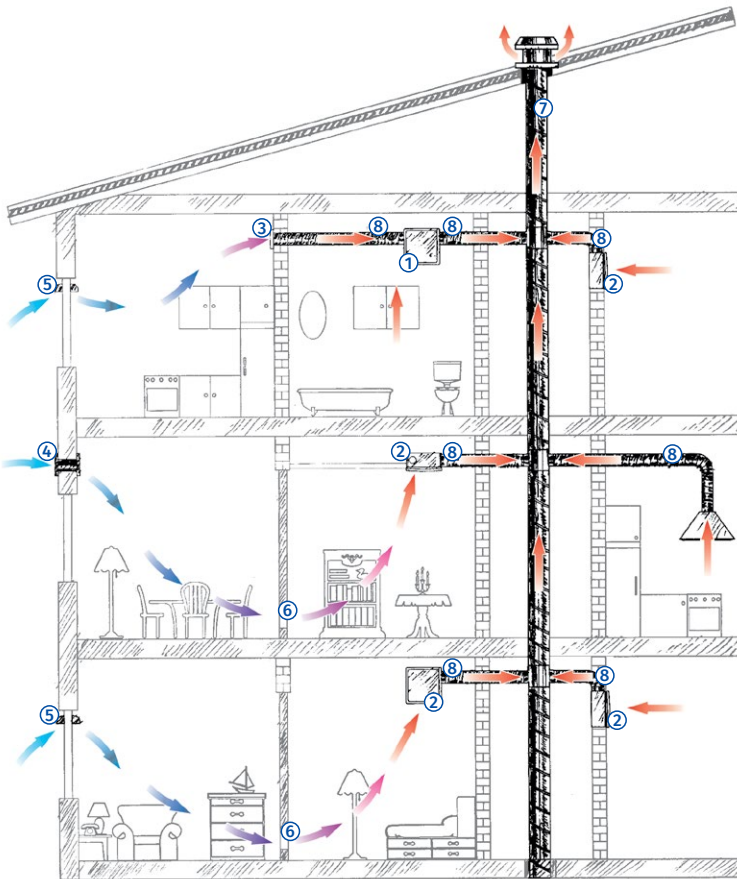

- 1 - Exhaust fan **Valeo-BPD** with an additional spigot for - room-to-room ventilation.
- 2 - Exhaust fan **Valeo-BP**.
- 3 - BLAUBERG wall grille, **DECOR** series.
- 4 - BLAUBERG wall vent, **WHM** series.
- 5 - BLAUBERG window vent, **FHM** series.
- 6 - BLAUBERG ventilation door grilles, **DECOR** series.
- 7 - Central ventilation shaft.
- 8 - Flexible air ducts for connection of exhaust fans to the central ventilation shaft, e.g. BLAUBERG air ducts, **BlauFlex** series.

VALEO-E

CENTRIFUGAL FANS

Use

- Exhaust ventilation systems installed in high-rise buildings and premises.
- For buildings with a mono-pipe ventilation system.
- For mounting in kitchens and bathrooms.
- Surface wall or ceiling mounting.



Air flow:
up to 100 m³/h
28 l/s



Power:
from 15 W
SFP:
from 1.04 W/l/s



Noise level:
from 27 dBA



Design

- The fan consists of a plastic casing for surface mounting and an exhaust ventilation unit **Valeo** with a flat front panel.
- The casing is made of durable ABS plastic and fitted with a gravity back-draft damper to prevent backdrafting.



- The front panel is made of snow-white UV-resistant plastic.
- Filter with filter class G4 for motor, impeller and ductwork system protection against soiling.
- The filter is easily accessible for service operations.
- Due to modern design and various colour modifications the front panel matches well with any interior.
- The casing is equipped with oblong slotted joints to facilitate mounting of the casing in true vertical position.
- Power is supplied to the fan through a sealed electric lead-in on the casing and the ventilation unit is equipped with an airtight terminal block for connection to the wiring system.
- Exhaust spigot diameter 80 mm.
- Ingress protection rating IP55.

Motor

- Two-speed motor with a centrifugal impeller. Minimum energy demand.
- The impeller has forward curved blades.
- Automatic maintaining of constant air flow depending on variable air resistance of the duct.
- Balanced impeller ensures low noise operation.
- Best aerodynamic characteristics due to a special scroll casing design.
- Ball bearings provide long service life.
- The ventilation unit with a motor is fixed inside the casing with special latches.

Speed control

- Step speed control with an external speed controller, e.g. a **CDP-3/5** model which is available upon order.
- Wide range of intellectual controls programmable by set parameters (timer, adjustable timer, internal switch, photo sensor, humidity sensor).

Designation key

Valeo-E	35/60	TR
Model	Air flow according to speed	Option

Accessories

Filter	Flexible air duct	Speed controller	Clamp
 FP-Valeo	 BlauFlex AN	 CDP-2/5	 K

VALEO-E

CENTRIFUGAL FANS

Options

o Timer (Valeo-E...T)

Depending on wiring connection the fan is off or runs permanently at low speed. The fan is turned to higher speed with an external switch 50 s after activation. After turning the switch off the fan continues operating within 6 min at higher speed and then reverts to default operation mode.

o Adjustable timer (Valeo-E...TR)

Depending on wiring connection the fan is off or runs permanently at low speed. If the fan is turned on with an external switch, it switches to higher speed 0 to 150 s after switch activation. After turning the fan off it continues running at higher speed 2 to 30 minutes and then reverts to the previous mode. The fan run-out time and delay time for higher speed are regulated with the internal regulator.

o Interval switch (Valeo-E...I)

Depending on wiring connection the fan is off or runs permanently at low speed. In interval mode regulated from 0.5 to 15 hours the fan switches periodically to higher speed for 10 minutes. The switch interval is adjusted with the internal regulator. If the light in the room is turned with the external switch, the fan switches to higher speed in 50 s. After light is off the fan reverts to the interval mode operation.

o Humidity sensor (Valeo-E...H)

Depending on wiring connection the fan is off or runs permanently at low speed. The fan switches to higher speed as relative humidity in the room increases from 60 % up to 90 % and switches off as humidity drops by 10 % below the set level. If the light in the room is turned on, the fan switches to higher speed in 50 s. The run-out time is set by the internal regulator from 2 to 30 minutes.

Mounting

- o Flexible air ducts connected to the ductwork system and wiring are routed to the fan through the wall or ceiling.
- o After finishing works a flexible air duct is fixed on the fan spigot with clamps.
- o Power is supplied to the fan through a sealed electric lead-in on the casing.
- o The casing is installed at site with dowels and is adjusted vertically with oblong slotted joints.
- o The ventilation unit connected to the wiring system is installed in the mounted and fixed casing.

Mounting example

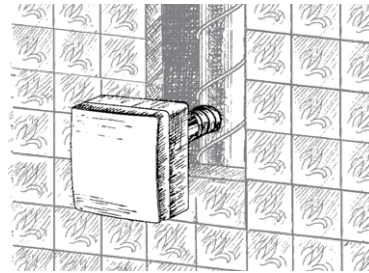

Overall dimensions [mm]

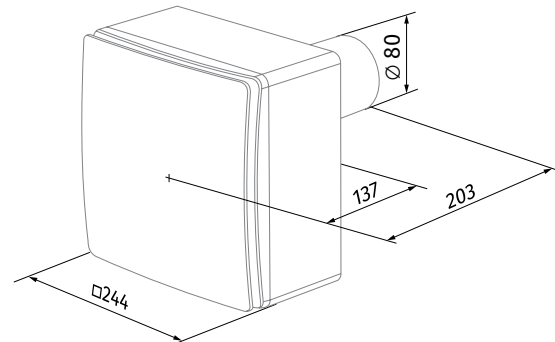

VALEO-E

CENTRIFUGAL FANS

Technical data

Model	Valeo-E 35/60	Valeo-E 75/100
Speed	I / II	I / II
Voltage [V/Hz]	220-240/50	220-240/50
Power [W]	15 / 25	24 / 29
Current [A]	0.12 / 0.14	0.11 / 0.13
Cable cross section [mm ²]	3x1.5	3x1.5
Maximum air flow [m ³ /h (l/s)]	35 (10) / 63 (18)	75 (21) / 100 (28)
Sound pressure level [dBA]*	27 / 36	29 / 38
Max. transported air temperature [°C]	+50	+50
IP rating	IP55	IP55

* Sound pressure level measured in free space at a distance of 3 meters from the fan.

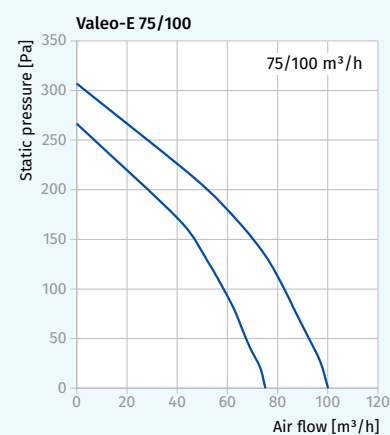
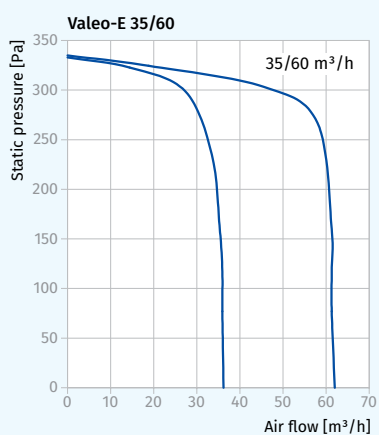

- The abrupt curves show high pressure performance and constant air flow of several **Valeo-E** fans integrated into a single ventilation shaft.

VALEO-E

CENTRIFUGAL FANS

High-rise mono-pipe ventilation system arrangement example

- The mechanical centralized mono-pipe exhaust ventilation system for kitchens and bathrooms based on **Valeo-E** fans is specially designed for high-rise residential premises.
- Fresh air is supplied to bedrooms, children's room or living rooms through windows or wall vents. Vent modifications with air volume regulation are available.

- Stale air is extracted from the room by the exhaust fans through the inside doors or door grilles in the kitchen, bathroom or WC.
- This ventilation system arrangement ensures non-stop controllable air circulation in the room, comfortable microclimate and high fire safety.

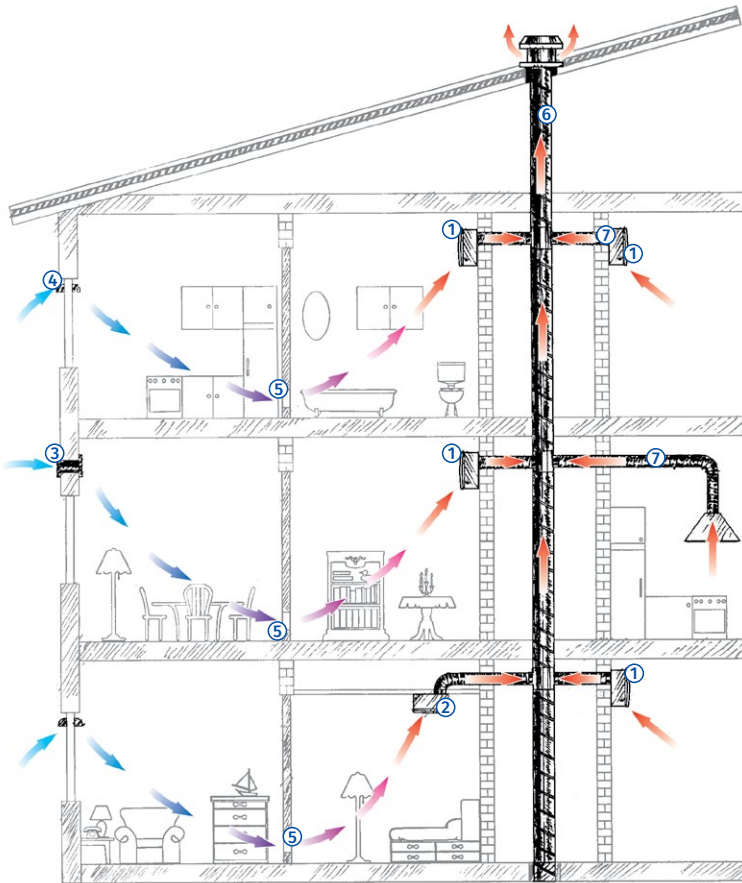

- 1 - Exhaust fan **Valeo-E** (surface mounting).
- 2 - Exhaust fan **Valeo-E** (ceiling mounting).
- 3 - BLAUBERG wall vent, **WMH** series.
- 4 - BLAUBERG window vent, **FHM** series.
- 5 - BLAUBERG ventilation grilles, **DECOR** series.
- 6 - Central ventilation shaft.
- 7 - Flexible air ducts for connection of exhaust fans to the central ventilation shaft, e.g. BLAUBERG air ducts, **Blauflex** series.

FORCE / FORCE MAX

CENTRIFUGAL FANS

Features



- Centrifugal fans.
- Wall surface or flush mounting.
- Centrifugal impeller with forwards curved blades ensures high pressure.
- Gravity backdraft damper for back flow prevention.
- Removable grille with a dust filter.
- Modification with a grease filter (model Force...A) for use as a kitchen exhaust hood.
- Continuous operation.
- 5 years warranty.



Air flow:
up to 122 m³/h
34 l/s



Power:
from 16 W
SFP:
from 0.59 W/l/s



Noise level:
from 36 dBA



Options



Model	Force (Max) 100					
Option	S	T	ST	H	SH	IR
Pull cord switch	•		•		•	
Timer		•	•	•	•	•
Humidity sensor				•	•	
Motion sensor						•

- Timer**
 - Adjustable delay from 2 to 30 min.
- Humidity sensor**
 - Humidity setpoint adjustable from 60 % up to 90 %.
 - Turn-off delay adjustable from 2 up to 30 min.
- Motion sensor**
 - Detection range from 1 up to 4 m.
 - Detection angle up to 100°.
 - Turn-off delay adjustable from 2 up to 30 min.

Overall dimensions

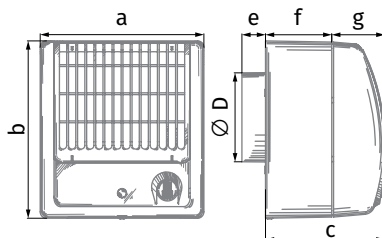

Dimensions [mm]	a	b	c	Ø D	e	f	g
Force (Max) 100	180	195	132	98	26	73	59

Technical data

Model	Force 100	Force Max 100
Voltage [V/Hz]	220-240/50	220-240/50
Power [W]	16	29
Air flow [m ³ /h (l/s)]	98 (27)	122 (34)
SFP [W/l/s]	0.59	0.86
Sound pressure level [dBA]*	36	38
RPM [min ⁻¹]	2250	2500

* Sound pressure level measured in free space at a distance of 3 meters from the fan.

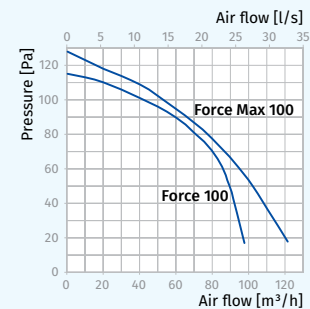

Designation key

Force	Max	100	T	A
Model	High-powered motor	Spigot diameter	Option	Grease filter

Accessories

Duct system	Flexible air ducts	Grilles and hoods	Speed controllers	Clamps	Replaceable filters	
BlauPlast	BlauFlex	Decor, GM	CDT E1.8	MCD 60/0.3	K, KZ	FP(A)-Force FP-Force

FRESHER

WALL VENTS

Features

- Efficient energy saving supply ventilation in flats, houses, cottages, social and commercial spaces.
- Coarse and fine filters ensure fresh filtered air supply to premises.
- Various operation modes and regulated air exchange create individually controlled microclimate.
- Organization of the air supply system with centralized control based on several ventilation units.



Air flow:
up to 50 m³/h
14 l/s



Power:
from 3.8 W

SFP:
from 0.48 W/l/s



Noise level:
from 13 dBA



Design

The ventilator consists of a cartridge with filters, an air duct with sound absorbing material, an indoor unit with a decorative front panel and an outer ventilation hood. The cartridge consists of an energy efficient EC fan and filters that ensure coarse and fine filtration of supply air. The indoor unit is in the basic version equipped with automatic shutters that close during the

ventilator standstill and prevent air backdraft. The outer ventilation hood is used to prevent direct ingress of water and other objects to the ventilator. A remote control, an extended air duct (700 mm) and different external grilles are optionally available for the Fresher 50 units.

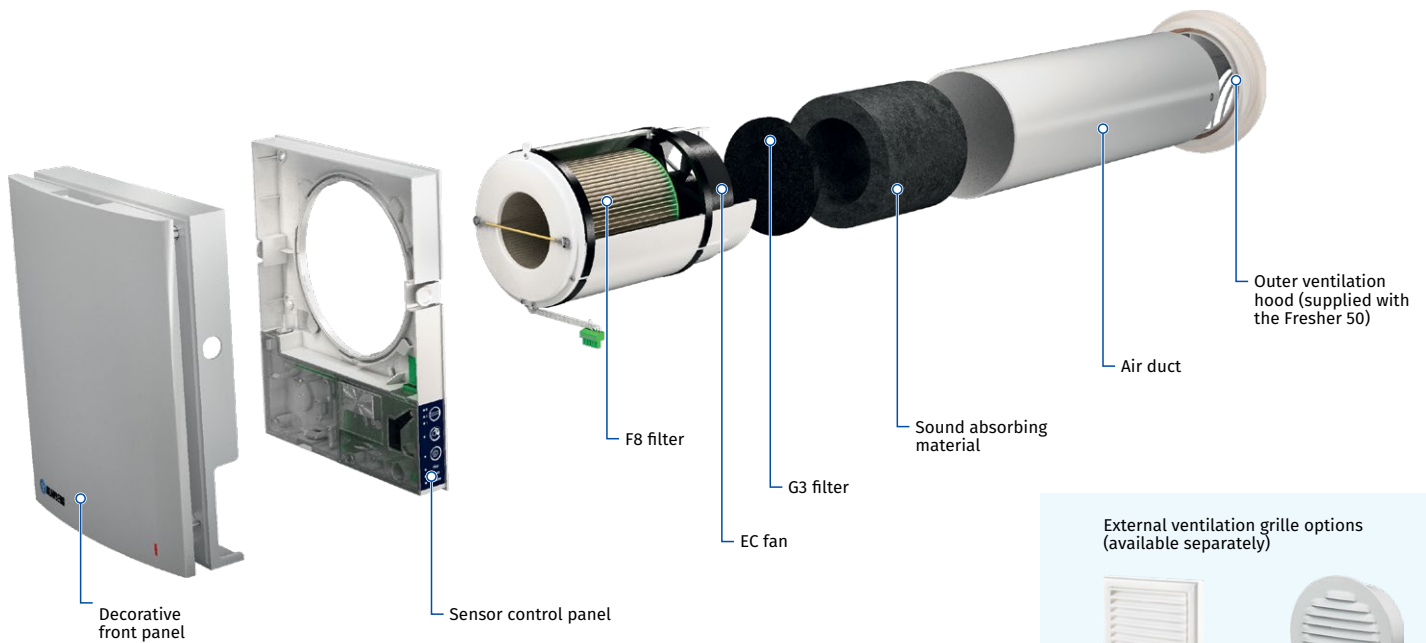

External ventilation grille options (available separately)



Decor
185x185/150s



Decor
150s St white



Easy maintenance. The indoor unit can be opened applying a light pressure from both sides



The built-in automatic air shutters prevent back air draft

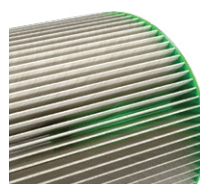

One of the highest air cleaning efficiency ratings on the market through the use of a modern filter system



The specially designed front panel provides 100 % tightness and wind protection

FRESHER

WALL VENTS

Control

The ventilator can be operated with the sensor control panel on the unit casing or with the remote control (FB Fresher 50).

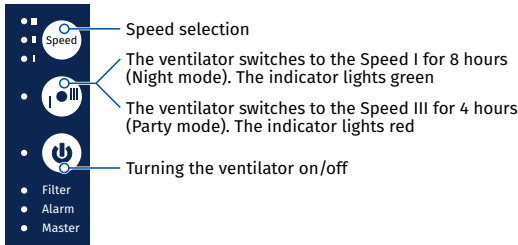

Remote control

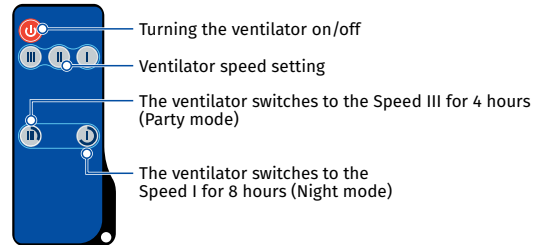

The ventilator design enables connecting any external controls, such as a humidity sensor, an external CO₂ sensor or a switch. Connection of several ventilators in series provides effective, optimal ventilation. The first unit

in series becomes the master unit. Ventilation mode is controlled via the control panel on the master unit. The signal from the remote control is received by the first ventilator (master) only.

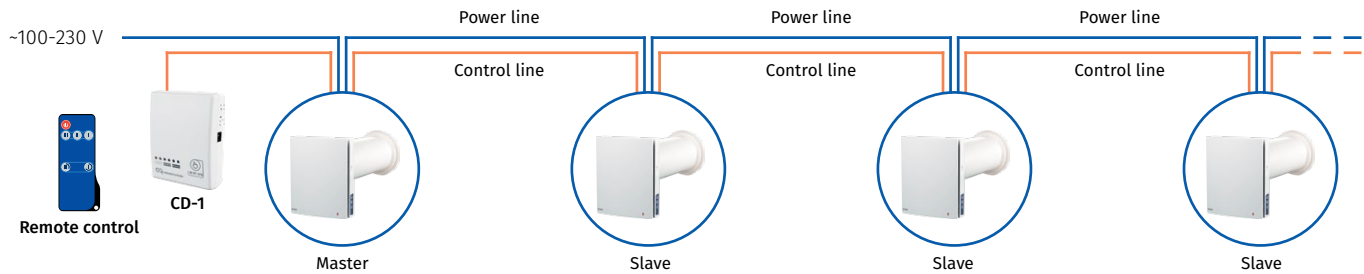

Mounting

The unit is designed for through-the-wall mounting into a round hole provided in the outer wall. The unit installation in new-construction buildings is carried out in two phases:

1 Preassembly at the stage of interior and exterior finishing of walls (installing the air duct and the outer ventilation hood, electrical cable laying)

2 Final assembly – before commissioning the house. It includes installation of the cartridge with the fan and filters as well as installation and connection of the indoor unit with the controller and air shutters.

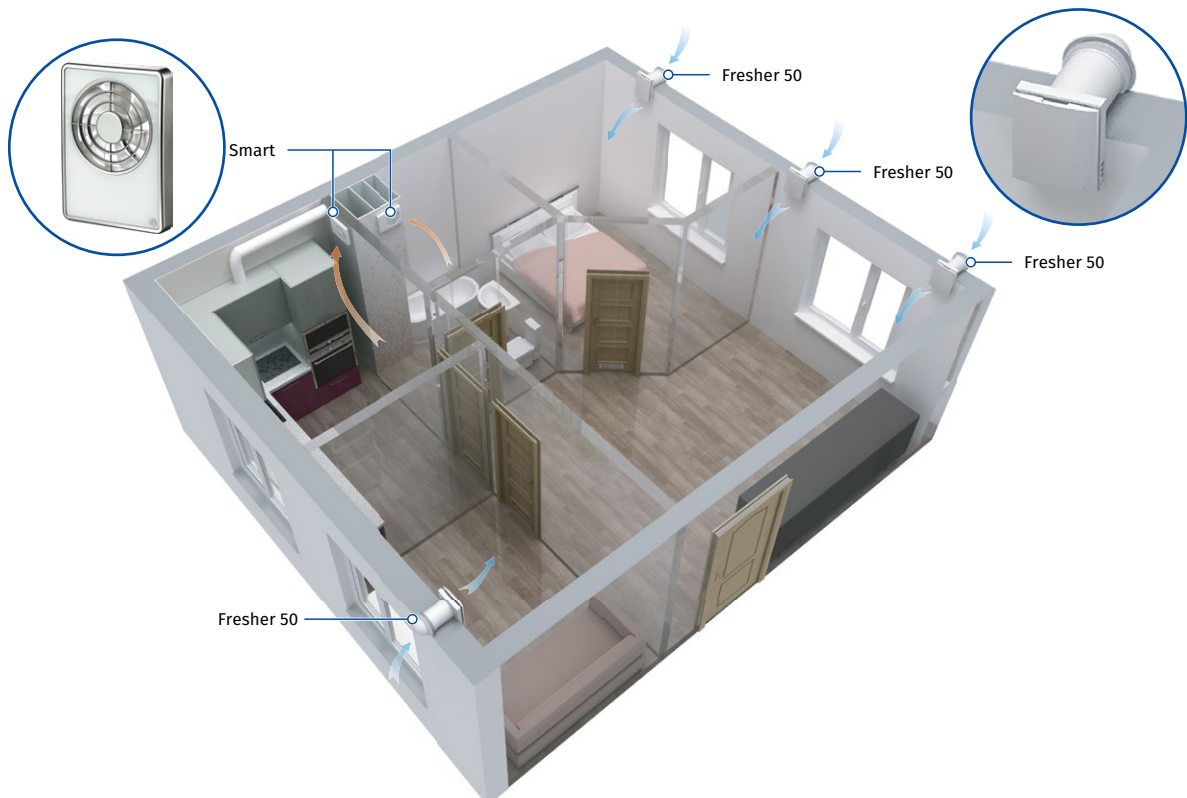

FRESHER

WALL VENTS

Overall dimensions [mm]

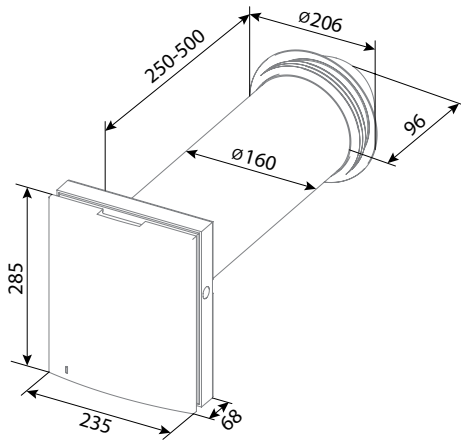

Fresher 50

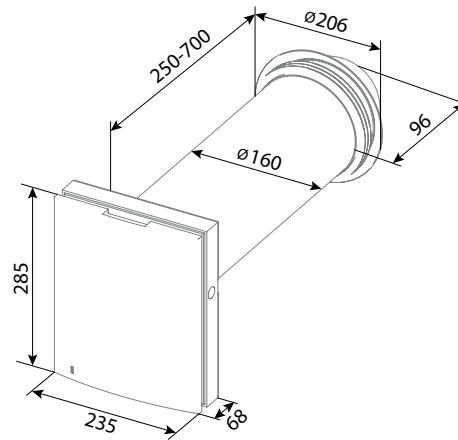

Fresher 50 L

Technical data

Model	Fresher 50 / Fresher 50 L		
	I	II	III
Speed			
Voltage [V/50 (60) Hz]		1~100-240	
Power [W]	3.8	4.7	7.4
Current [A]	0.031	0.039	0.061
Air flow [m ³ /h (l/s)]	20 (6)	35 (10)	50 (14)
SFP [W/l/s]	0.68	0.48	0.53
Transported air temperature [°C]		from -30 to +50	
Sound pressure level at a distance of 1 m [dBA]*	22	29	32
Sound pressure level at a distance of 3 m [dBA]*	13	20	23
Outdoor noise attenuation [dBA]		41	
PM 2.5 removal efficiency [%]		98	
Ingress protection		IP24	

*Sound pressure level measured in free space.

Ecodesign parameters





Trade mark	BLAUBERG					
Model	Fresher 50					
Specific energy consumption (SEC) [kWh (m ² a)]	Cold		Average		Warm	
	-53.2	A+	-26.1	B	-10.6	E
Type of ventilation unit	Unidirectional					
Type of drive installed	Multi-speed					
Type of heat recovery system	No					
Thermal efficiency of heat recovery [%]	n/a					
Maximum air flow [m ³ /h]	50					
Power [W]	6.6					
Sound power level [dBA]	40					
Reference flow rate [m ³ /s]	0.01					
Reference pressure difference [Pa]	n/a					
Specific power input (SPI) [W/m ³ /h]	0.134					
Control typology	Local demand control					
Maximum internal leakage rates [%]	n/a					
Maximum external leakage rates [%]	2.7					
Internet address	https://www.blaubergventilatoren.de/					
The annual electricity consumption (AEC) [kWh electricity/a]	Cold		Average		Warm	
	88		88		88	
The annual heating saved (AHS) [kWh primary energy/a]	Cold		Average		Warm	
	5536		2830		1280	

FRESHER

WALL VENTS

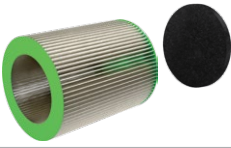
Designation key						
Fresher	50	L: 500 L: 700	_: air shutters M: no air shutters	_: ventilation hood by default 1: outer grille Decor 150s St white 2: outer grille Decor 185x185/150s S: brushed stainless steel ventilation hood AH-S chrome 160 (for thin walls) S white: brushed stainless steel ventilation hood painted white AH-S chrome 160 (for thin walls) S10 chrome: plastic ventilation hood AH-10 chrome 160 S10: plastic ventilation hood AH-10 white 160	_: without remote control FB: with remote control	
Model	Rated air flow [m³/h]	Air duct length [mm]	Air shutters	External grille type		Option

Accessories

Accessory name	Description
FP Fresher 50 F8 	Filter kit: G3 filter (1 pc) + F8 filter (1 pc)
FB Fresher 50 	Remote control
CD-1 	CO ₂ sensor with LED CO ₂ indication and a sensor button for operation mode selection
CD-2 	CO ₂ sensor
HR-S 	Room humidistat

WHM

WALL VENT

Features

- For installation in the outer wall of the room
- Provides steady fresh air intake
- Supplied with a dust G3 filter
- Manual adjustment of effective cross section
- Easy maintenance
- Telescopic duct
- Equivalent area 3580 mm²



Modifications

WHM 100 DR – with a round external grille.

WHM 100 DR (colour) – with an external colour grille.

Decor 100s



grey

brown

WHM 100 DQ – with an external white square grille.

WHM 100 DQ (colour) – with an external colour square grille.

Decor 140x140/100s



grey

brown

WHM 100 DK – with a ventilation hood.

WHM 100 DK (colour) – with a colour ventilation hood.

Decor 155x155/100H Decor 100s



grey

brown

WHM 100 DS – with a stainless steel ventilation hood.

Decor 140x140/100s



Technical data

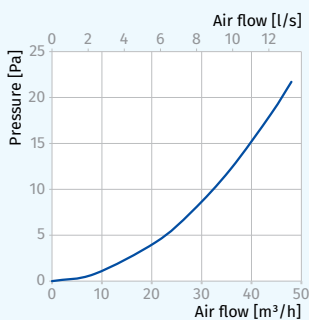

Designation key

WHM	100	DK	Grey
Model	Spigot diameter	Type of external grille	Colour

Overall dimensions [mm] and mounting

Internal grille

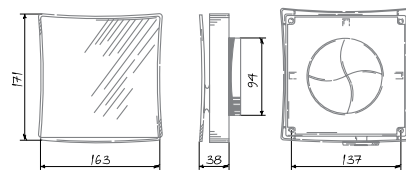

External grille (plastic)

Square external grille

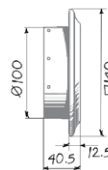

Round external grille

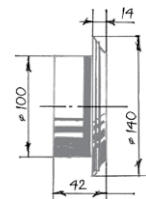

Ventilation hood

Plastic ventilation hood

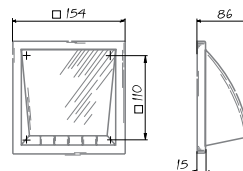

Stainless steel ventilation hood

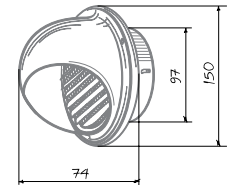

Telescopic duct

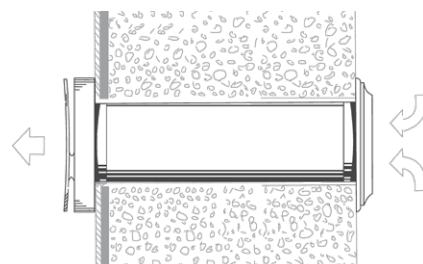
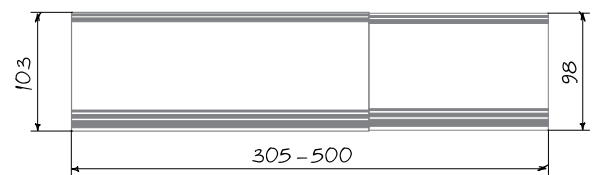

Accessories

Filter G3



FP 143x143x10 G3

SHM

WALL VENTS WITH SOLAR PANEL

Features



- Power-independent operation due to the use of a solar-powered motor.
- Efficient and environmentally friendly operation based on natural resources.
- Operation as ordinary passive vents in case of no solar energy supply.
- Higher exchange rate as compared to other standard passive ventilation components.
- Uniform air supply and distribution free of dust and noise.
- Mounting on outer sun-facing walls.
- The internal grille is made of high-quality ABS plastic and is equipped with a G3 dust filter.
- Equipped with an axial fan driven by a solar-powered DC motor.



- The fan operates either in supply or exhaust mode depending on its modification.
- The round air flow regulator provides smooth regulation of air flow or shutoff of the ventilation duct.



- Telescopic duct with adjustable length from 250 to 390 mm is made of durable PVC plastic.
- 100 mm air duct diameter.
- The outer ventilation hood is made of high-quality ABS plastic.
- Solar panel is fixed directly on the hood surface.

Overall dimensions [mm]

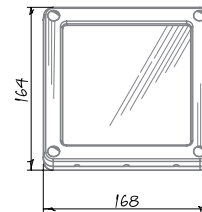
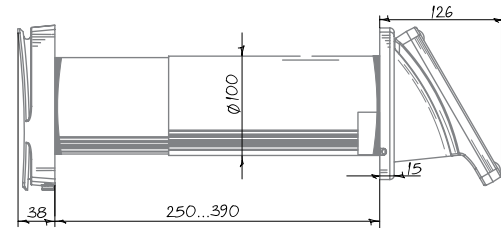
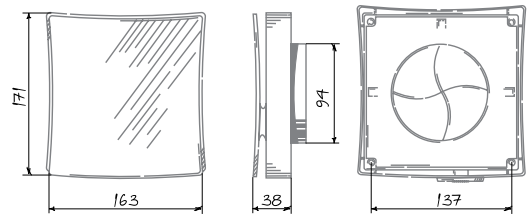

Technical data

Model	SHM 100 DK
Battery power [W]	2.5
Air flow [m ³ /h (l/s)]	20
Spigot diameter [mm]	100

Air flow rate in various directions

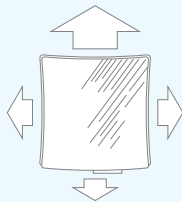

Designation key		
SHM	100	DK
Model	Spigot diameter	Type of external grille

Accessories	
Filter G3	



FP 143x143x10 G3

FHM

WINDOW VENTS

Features

- Installation in window frames.
- Uniform natural air flow, free of drafts and outside noise.
- Integrated dust filter ensures fresh air supply and prevents ingress of dirt and dust into the room.
- Regulation of supply air flow direction due to adjustment of the inner grille.
- Outer hood against water ingress.
- Easy mounting and maintenance.
- Temperature and UV resistant antistatic plastic.
- Available in grey and brown colours; White – by default.



Grey



Brown

Overall dimensions [mm]

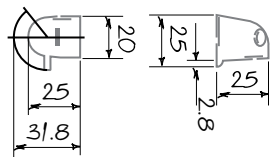
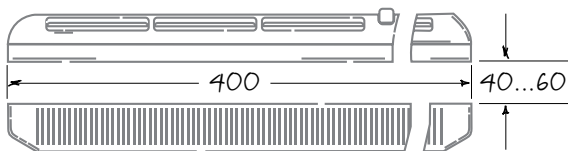

Technical data

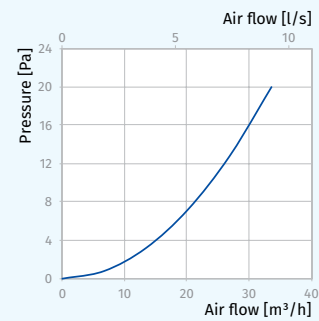

Designation key

FHM	400	Grey
Model	Length	Colour

KIT AERO-BW

HEAT TRANSFER KITS

Features



- For premises heated with chimneys and other heating systems.
- Provides hot air circulation from heated rooms to other premises.
- Installation into outer and dividing walls.
- Supplied with a thermostat (automatically switches the fan on at set temperature from 10 to 30 °C).
- Telescopic duct for wall installation.
- Continuous operation.
- Ball bearing motor.
- Easy maintenance.
- 5 year warranty.



Air flow:
84 m³/h
23 l/s



Power:
5.5 W
SFP:
0.24 W/l/s



Noise level:
25 dBA



KIT Aero-BW 100/40-1



Fan Aero Still 100



Round telescopic duct BlauPlast RTR 100



Round grille Decor 100s



Thermostat TS E10

Overall dimensions [mm] and mounting

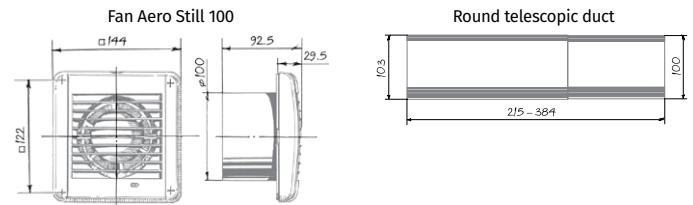

KIT Aero-BW 100/40-2



Fan Aero Still 100



Round telescopic duct BlauPlast RTR 100



Square grille Decor 140x140/100s



Thermostat TS E10

Square grille

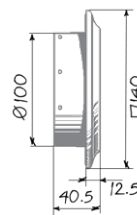

Round grille

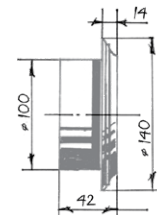

Thermostat

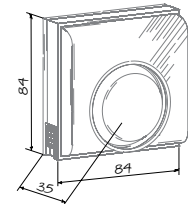

Technical data

Model	KIT Aero-BW 100/40 (Aero Still 100)
Voltage [V/Hz]	220-240/50
Power [W]	5.5
Air flow [m³/h (l/s)]	84 (23)
SFP [W/l/s]	0.24
Sound pressure level [dBA]*	25

* Sound pressure level measured in free space at a distance of 3 meters from the fan.

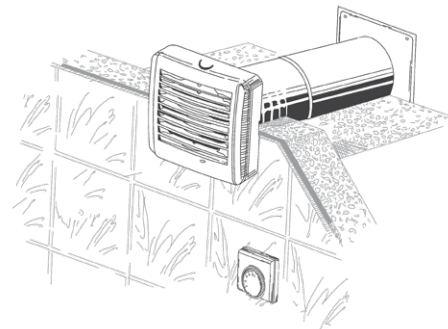
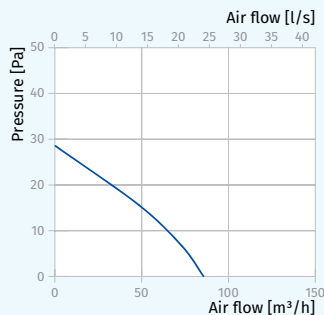

KIT BRAVO-BW

HEAT TRANSFER KITS

Features



- For premises heated with chimneys and other heating systems.
- Provides hot air circulation from heated rooms to other premises.
- Installation into outer and dividing walls.
- Supplied with a thermostat (automatically switches the fan on at set temperature from 10 to 30 °C).
- Telescopic duct for wall installation.
- Continuous operation.
- Ball bearing motor.
- Easy maintenance.
- 5 year warranty.



Air flow:
70 m³/h
19 l/s



Power:
5.6 W



SFP:
0.29 W/l/s



Noise level:
26 dBA



KIT Bravo-BW 100/40-1



Fan Bravo Still 100



Round telescopic duct BlauPlast RTR 100



Round grille Decor 100s



Thermostat TS E10

KIT Bravo-BW 100/40-2



Fan Bravo Still 100



Round telescopic duct BlauPlast RTR 100



Square grille Decor 140x140/100s



Thermostat TS E10

Overall dimensions [mm] and mounting

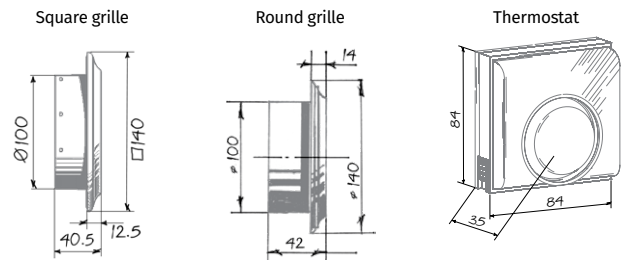
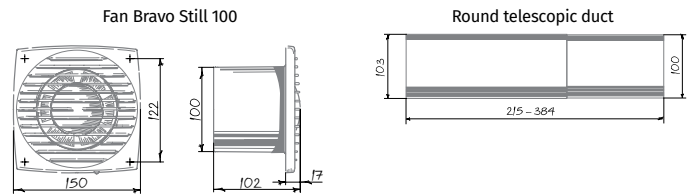

Technical data

Model	KIT Bravo-BW (Bravo Still 100)
Voltage [V/Hz]	220-240/50
Power [W]	5.6
Air flow [m ³ /h (l/s)]	70 (19)
SFP [W/l/s]	0.29
Sound pressure level [dBA]*	26

* Sound pressure level measured in free space at a distance of 3 meters from the fan.

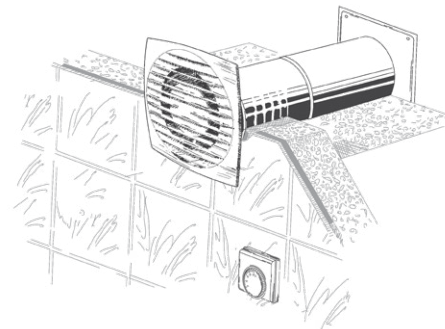
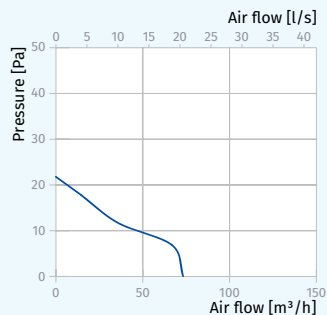

DECOR S HK

METAL HOODS

Features

- Outer wall mounting
- Decoration of ventilation shaft vents and connection to round air ducts
- Equipped with a backdraft damper for back flow prevention
- Made of stainless steel
- Equipped with a rubber sealing ring



Overall dimensions and mounting

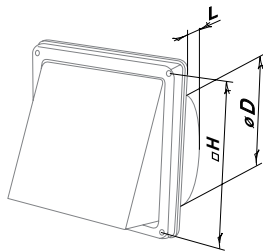

Model	Dimensions [mm]			Air pass [m ²]
	∅ D	H	L	
Decor S 137*137/102HK	97	137	52	0.0071
Decor S 167*167/122HK	120	167	52	0.0113
Decor S 167*167/152HK	145	167	62	0.0165

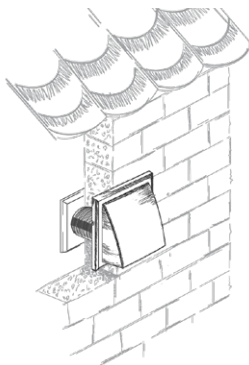

DECOR S HK

METAL HOODS

Features

- Outer wall mounting
- Decoration of ventilation shaft vents and connection to round air ducts
- Protection grille against birds and rodents
- Made of stainless steel
- Equipped with a rubber sealing ring



Overall dimensions

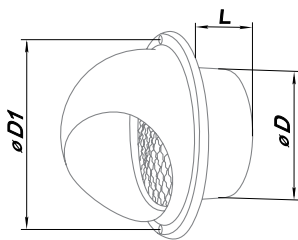

Model	Dimensions [mm]			Air pass [m ²]
	Ø D	Ø D1	L	
Decor S 102 HK	97	133	52	0.0048
Decor S 122 HK	120	165	52	0.0082
Decor S 152 HK	145	192	62	0.0126
Decor S 162 HK	155	192	62	0.0135
Decor S 202 HK	195	253	62	0.0178

DECOR H

PLASTIC HOODS

Features

- Outer wall mounting
- Decoration of ventilation shaft vents or for connection to rectangular or round air ducts
- Modification may include a gravity backdraft damper for back flow prevention
- Protection grille against birds and rodents
- Temperature- and UV-resistant antistatic plastic
- Flush mounting is possible
- Flush mounted fasteners
- Easy maintenance



Options

Model	Basic Model	Valve	Spigot
Decor 155x155H	•		
Decor 155x155/100H			•
Decor 155x155/100HK		•	•
Decor 155x155HK		•	
Decor 155x155/HU			•
Decor 155x155/HUK		•	•
Decor 185x185H	•		
Decor 185x185HK		•	
Decor 185x185/125H			•
Decor 185x185/125HK		•	•
Decor 185x185/150H	•		•
Decor 185x185/150HK		•	•

Without spigot



Backdraft damper

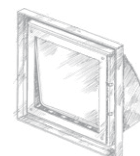

Non-adjustable spigot

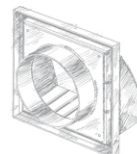

Universal spigot

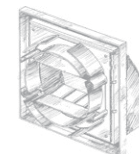

Overall dimensions and mounting

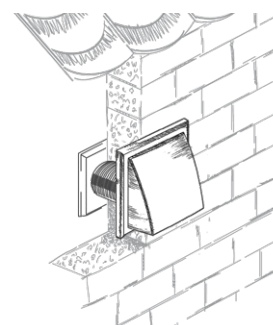
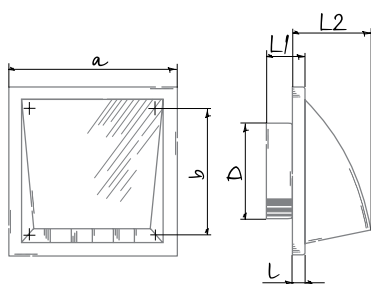

Model	Dimensions [mm]						Air pass [m ²]
	a	b	l	L1	L2	∅ D	
Decor 155x155H	154	110	15	-	87	-	0.008
Decor 155x155/100H	154	110	15	45	87	100	0.008
Decor 155x155/100HK	154	110	15	45	87	100	0.008
Decor 155x155HK	154	110	15	-	87	-	0.008
Decor 155x155/HU	154	110	15	39	87	100, 125, 55 × 110	0.08
Decor 155x155/HUK	154	110	15	39	87	100, 125, 55 × 110	0.08
Decor 185x185H	186	142	15	-	101	-	0.012
Decor 185x185HK	186	142	15	-	101	-	0.012
Decor 185x185/125H	186	142	15	45	101	125	0.012
Decor 185x185/125HK	186	142	15	45	101	125	0.012
Decor 185x185/150H	186	142	15	50	101	150	0.012
Decor 185x185/150HK	186	142	15	50	101	150	0.012

DECOR G

PLASTIC GRAVITY GRILLES

Features

- o Outer wall mounting
- o Decoration of ventilation shaft vents or for connection to round air ducts
- o Equipped with gravity louvre shutters for back flow prevention
- o Temperature- and UV-resistant antistatic plastic
- o Flush mounted fasteners
- o Easy maintenance



Options

Model	Basic Model	Spigot
Decor 155x155G	•	
Decor 155x155/UG		•
Decor 185x185G	•	
Decor 185x185/125G		•
Decor 250x250G	•	
Decor 250x250/150G		•

Without spigot



Non-adjustable spigot
Ø 125 mm, Ø 150 mm

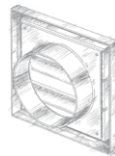

Universal spigot
Ø 100 mm, Ø 125 mm, 55 x 110 mm

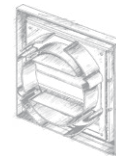

Overall dimensions and mounting

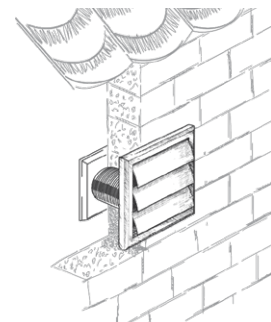
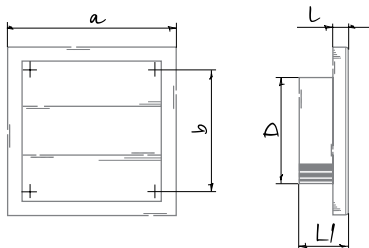

Model	Dimensions [mm]			L1	Ø D	Air pass [m²]
	a	b	l			
Decor 155x155G	154	110	15	-	-	0.0096
Decor 155x155/UG	154	110	15	45	100, 125, 55 x 110	0.0096
Decor 185x185G	186	142	15	-	-	0.016
Decor 185x185/125G	186	142	15	45	125	0.0113
Decor 250x250G	250	214	15	-	-	0.0177-0.056
Decor 250x250/150G	250	214	15	41	150	0.0177-0.056

GM

METAL GRAVITY GRILLES

Features

- Outer wall mounting
- Decoration of ventilation shaft vents
- The grille frame is made of grey polymer coated steel
- Equipped with louvre shutters made of deformation-resistant plastic for back flow prevention
- Screw fixing, flush mounting possible
- Easy maintenance



Overall dimensions

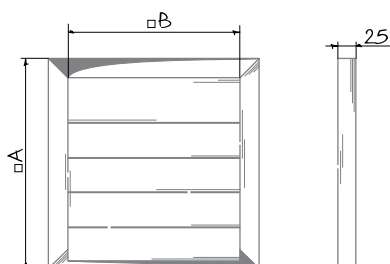

Model	Dimensions [mm]		Weight [kg]
	A	B	
GM 200	200	150	0.4
GM 250	250	200	0.54
GM 285	284	234	0.56
GM 300	300	250	0.68
GM 335	334	284	0.72
GM 350	350	300	0.82
GM 385	384	334	0.87
GM 400	400	350	0.97
GM 435	434	384	1.02
GM 450	450	400	1.11
GM 485	484	434	1.17
GM 535	534	484	1.32
GM 585	584	534	2.22
GM 635	634	584	2.46
GM 715	714	664	3.86

Front



Back



DECOR-M

METAL GRILLES

Features

- Wall or ceiling mounting
- Decoration of ventilation shaft vents
- Made of aluminium with paintable surface
- Screw fixing
- Equipped with a protecting insect screen (s)
- Easy maintenance



white



grey



beige



brown



Overall dimensions

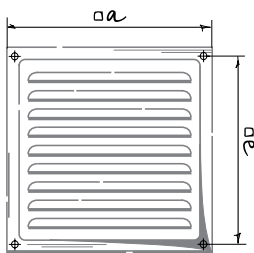

Model	Dimensions [mm]		Air pass [m²]
	a	e	
Decor-M 125x125s A colour*	125	111	0.0035
Decor-M 150x150s A colour*	150	136	0.006
Decor-M 200x200s A colour*	200	182	0.0117
Decor-M 250x250s A colour*	250	234	0.0166
Decor-M 300x300s A colour*	300	284	0.0249

* colour – Grille colour

VDA CFN AL

METAL GRILLES

Features

- Decoration of exhaust vents in residential, public and industrial buildings.
- For ventilation, air conditioning and heating systems.
- Outer wall mounting.
- Made of cast aluminium.
- The round spigot enables connection to a round air duct.
- A large-mesh protecting stainless steel screen.
- Fixing to air ducts with screws.



Overall dimensions

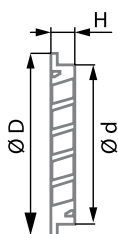

Model	Dimensions [mm]			Air pass [m ²]
	Ø D	Ø d	H	
VDA 100 CFn AL	125	100	20	0.00053
VDA 125 CFn AL	150	125	20	0.00076
VDA 150 CFn AL	180	150	18	0.0011
VDA 160 CFn AL	185	160	18	0.00125
VDA 200 CFn AL	225	200	20	0.00195
VDA 250 CFn AL	275	250	20	0.0029
VDA 315 CFn AL	350	315	20	0.0045
VDA 400 CFn AL	440	400	40	0.0075

DECOR

PLASTIC GRILLES

Features

- Wall or ceiling mounting
- Decoration of ventilation shaft vents or for connection to round air ducts
- Temperature- and UV-resistant antistatic plastic
- Flush mounting is possible
- Flush mounted fasteners
- Equipped with a protecting insect screen (s)
- Easy maintenance



Options

Without spigot

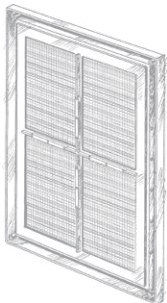

Adjustable spigot

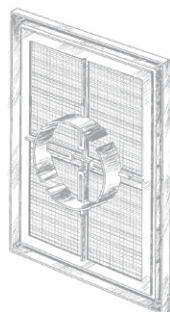

Model	Basic Model	Spigot
Decor 182x251s	•	
Decor 182x251/Vs		•
Decor 205x205s	•	
Decor 205x205/Vs		•

Overall dimensions

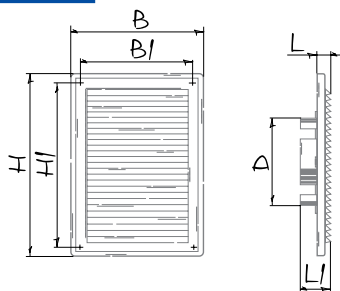

Model	Dimensions [mm]						Ø D	Air pass [m ²]
	H	B	H1	B1	L	L1		
Decor 182x251s	251	182	226	157	16	-	-	0.0127
Decor 182x251/Vs	251	182	226	157	16	41	100-150	0.0127
Decor 205x205s	204	204	179	179	16	-	-	0.092
Decor 205x205/Vs	204	204	179	179	16	41	100-150	0.092

DECOR

PLASTIC GRILLES

Features

- Wall mounting
- Easy maintenance
- For connection to rectangular or round air ducts
- Temperature- and UV-resistant antistatic plastic
- Equipped with a protecting insect screen (s)



Options

CONNECTION

Without spigot



Rectangular spigot



Non-adjustable spigot

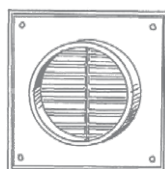

SHUTTERS

Gravity air shutters



ADJUSTMENT OF EFFECTIVE CROSS SECTION

Slide switch



Pull cord switch



Model	Basic Model	Spigot	Gravity air shutters	Manual adjustment
Decor 140x140s	•			
Decor 140x140/100s		•		
Decor 140x140Bs				
Decor 140x140Gs			•	
Decor 140x140Rs				•
Decor 140x140BRs				•
Decor 180x180s	•			
Decor 180x180/125s		•		
Decor 180x180Bs				
Decor 180x180Gs			•	
Decor 180x180Rs				•
Decor 180x180BRs				•
Decor 180x250s	•			
Decor 180x250Bs				
Decor 180x250Gs			•	
Decor 180x250Rs				•
Decor 180x250BRs				•
Decor 140x300s	•			
Decor 140x300Gs			•	
Decor 140x300Rs				•

DECOR

PLASTIC GRILLES

Overall dimensions and mounting

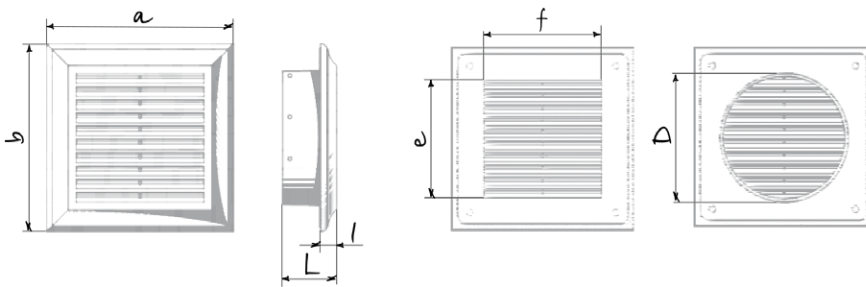

Model	Dimensions [mm]						Air pass [m ²]
	a	b	L	l	e x f	Ø D	
Decor 140x140s	140	140	40.5	12.5	100 x 100	-	0.0053
Decor 140x140/100s	140	140	40.5	12.5	100 x 100	100	0.0043
Decor 140x140Bs	140	140	-	12.5	100 x 100	-	0.0053
Decor 140x140Gs	140	140	40.5	12.5	100 x 100	-	0.0053
Decor 140x140Rs	140	140	40.5	12.5	100 x 100	-	0.0053
Decor 140x140BRs	140	140	-	12.5	100 x 100	-	0.0053
Decor 180x180s	180	180	40.6	12.6	138 x 138	-	0.0091
Decor 180x180/125s	180	180	40.6	12.6	138 x 138	125	0.0059
Decor 180x180Bs	180	180	-	12.6	138 x 138	-	0.0091
Decor 180x180Gs	180	180	40.6	12.6	138 x 138	-	0.0091
Decor 180x180Rs	180	180	40.6	12.6	138 x 138	-	0.0091
Decor 180x180BRs	180	180	-	12.6	138 x 138	-	0.0091
Decor 180x250s	180	250	40.6	12.6	138 x 208	-	0.0146
Decor 180x250Bs	180	250	-	12.6	138 x 208	-	0.0146
Decor 180x250Gs	180	250	40.6	12.6	138 x 208	-	0.0146
Decor 180x250Rs	180	250	40.6	12.6	138 x 208	-	0.0146
Decor 180x250BRs	180	250	-	12.6	138 x 208	-	0.0146
Decor 140x300s	140	300	40.6	12.6	100 x 255	-	0.0128
Decor 140x300Gs	140	300	40.6	12.6	100 x 255	-	0.0128
Decor 140x300Rs	140	300	40.6	12.6	100 x 255	-	0.0128

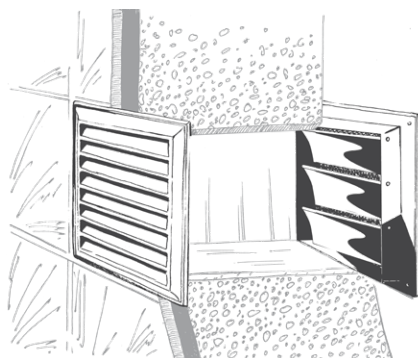

DECOR

PLASTIC GRILLES

Features

- Wall or ceiling mounting
- Decoration of ventilation shaft vents or for connection to round air ducts
- Temperature- and UV-resistant antistatic plastic
- Flush mounted fasteners
- Equipped with a protecting insect screen (s)
- Easy maintenance



Options

Without spigot

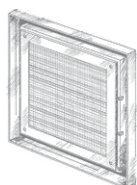

Non-adjustable spigot

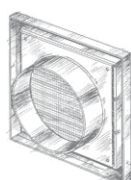

Universal spigot

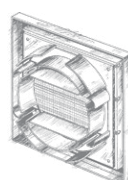

Adjustable spigot

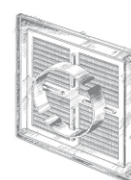

 Manual adjustment
of air pass

Model	Basic model	Spigot	Manual adjustment
Decor 155x155s	•	Ø 100, Ø 125, 55x110	
Decor 155x155/Us		Ø 100, Ø 125, 55x110	
Decor 155x155/URs			•
Decor 185x185s	•	Ø 125	
Decor 185x185/125s			
Decor 185x185Rs		Ø 125	•
Decor 185x185/125Rs			•
Decor 220x300s	•	Ø 100...150	
Decor 220x300/Vs			
Decor 250x250s	•		
Decor 250x250Rs		Ø 150	•
Decor 250x250/150s		Ø 150	
Decor 250x250/150Rs			•

DECOR

PLASTIC GRILLES

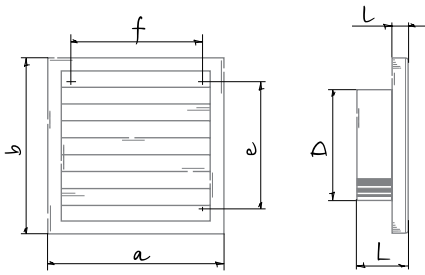
Overall dimensions and mounting



Model	Dimensions [mm]					e x f	Ø D	Air pass [m²]
	a	b	L	l				
Decor 155x155s	154	154	-	15		110 x 110	-	0.0067
Decor 155x155/Us	154	154	39	15		110 x 110	100, 125, 55x110	0.0067
Decor 155x155/URs	154	154	39	15		110 x 110	100, 125, 55x110	0.0049
Decor 185x185s	186	186	-	15		142 x 142	-	0.0115
Decor 185x185/125s	186	186	45	15		142 x 142	125	0.0083
Decor 185x185/150s	186	186	45	15		142 x 142	150	0.0083
Decor 185x185Rs	186	186	-	15		142 x 142	-	0.0062
Decor 185x185/125Rs	186	186	45	15		142 x 142	125	0.0044
Decor 185x185/150Rs	186	186	45	15		142 x 142	150	0.0044
Decor 220x300s	221	299	-	15		283 x 205	-	0.0026
Decor 220x300/Vs	221	299	42	15		283 x 205	100-150	0.0026
Decor 250x250s	250	250	-	14		214 x 214	-	0.02
Decor 250x250Rs	250	250	-	14		214 x 214	-	0.01
Decor 250x250/150s	250	250	44	14		214 x 214	150	0.02
Decor 250x250/150Rs	250	250	44	14		214 x 214	150	0.01

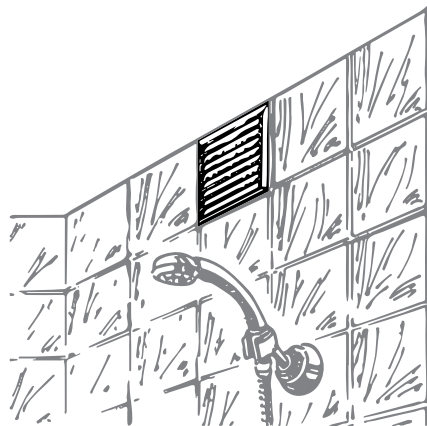

DECOR

PLASTIC GRILLES

Features

- Wall or ceiling mounting
- Connection to round air ducts
- Temperature- and UV-resistant antistatic plastic
- Equipped with a protecting insect screen (s)
- Easy maintenance



Overall dimensions and mounting

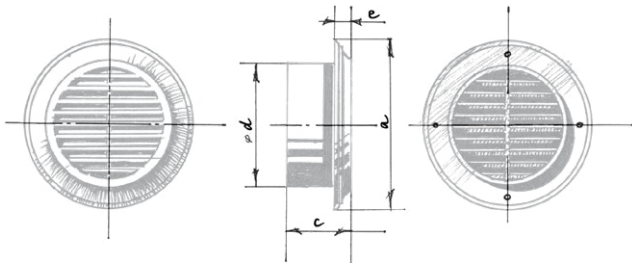

Model	Dimensions [mm]				Air pass [m ²]
	a	c	Ø d	e	
Decor 80s	123	42	80	14	0.0033
Decor 100s	140	42	100	14	0.0048
Decor 125s	165	42	125	14	0.0073
Decor 150s	188	42	150	14	0.0106

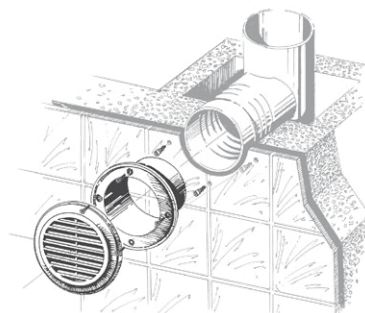
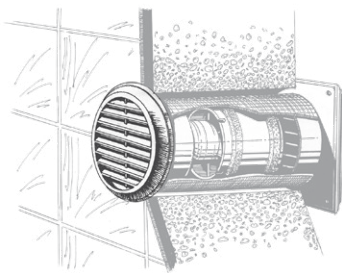

DECOR

PLASTIC GRILLES

Features

- o Wall or ceiling mounting
- o Easy maintenance
- o For connection to rectangular BlauPlast FK series air ducts
- o Temperature- and UV-resistant antistatic plastic



Options

- o Manual adjustment of air pass (R).

Overall dimensions and mounting

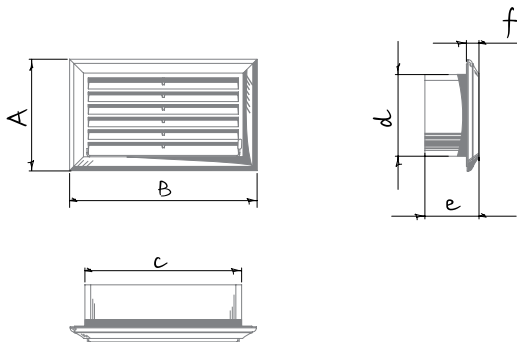

Model	Dimensions [mm]					
	A	B	c	d	e	f
Decor 81x136	88	137	114	59	73	9
Decor 81x136R	88	137	114	59	73	9
Decor 86x230	93	232	208	64	76	9
Decor 86x230R	93	232	208	64	76	9
Decor 86x230/220x55	93	232	224	59	76	9

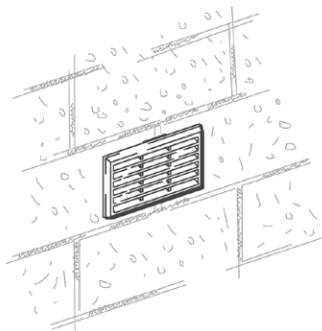

VMR

METAL AIR DISC VALVES

Features

- Ceiling or wall mounting
- Smooth air flow control
- Easy mounting with a mounting spigot
- Sealing ring
- Made of white polymer coated steel



Overall dimensions and mounting

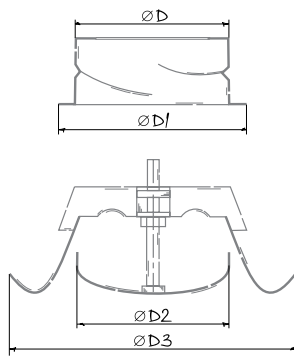

Model	Dimensions [mm]			
	Ø D	Ø D1	Ø D2	Ø D3
VMR 100	99	123	75	128
VMR 125	124	152	100	154
VMR 150	149	173	128	184
VMR 200	199	225	178	235

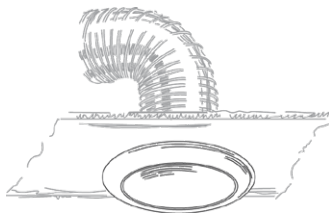

Technical data

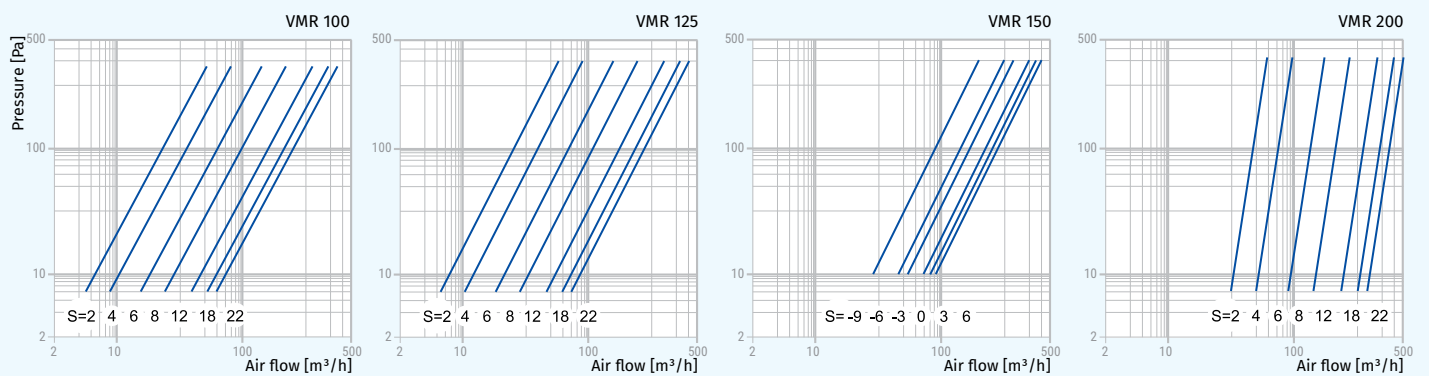

VMBR

METAL AIR DISC VALVES

Features

- For supply ventilation, air conditioning and heating.
- Designed for wall mounting or installation into false ceilings.
- Used to arrange correct air supply and circulation in premises.
- Made of polymer-coated steel.
- Special aerodynamic disk valve design ensures uniform air distribution.
- Smooth air pass regulation due to rotation of central part of the damper.
- Equipped with a mounting spigot for easy connection to round \varnothing 100-200 mm air ducts.
- Mounting spigot is fixed to a false ceiling with screws.
- The internal part has a sealing ring for more tight fit.



Overall dimensions and mounting

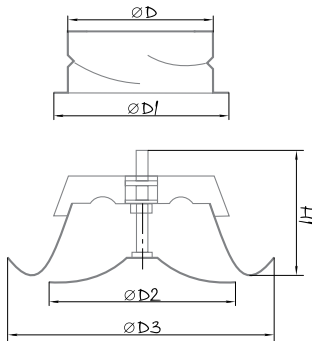

Model	Dimensions [mm]				
	$\varnothing D$	$\varnothing D1$	$\varnothing D2$	$\varnothing D3$	H1
VMBR 100	99	125	88	138	60
VMBR 125	124	150	112	167	60
VMBR 150	149	175	144	199	70
VMBR 200	199	225	200	249	70

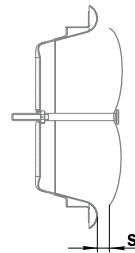
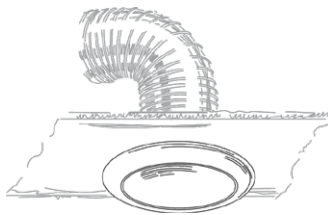

The internal part of the air disk valve is pulled out to ensure the required clearance S (mm) to provide required air flow according to the diagram.

Technical data

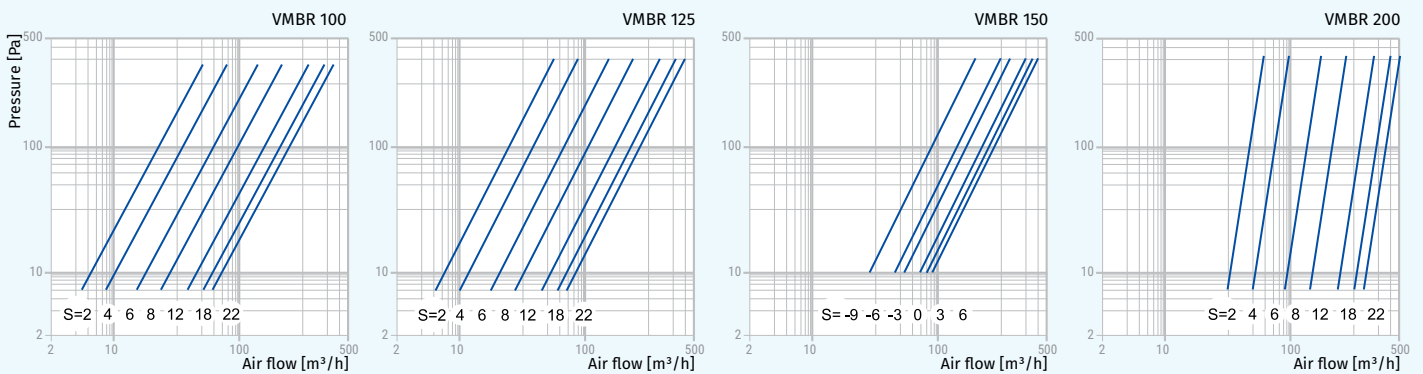

VSR

METAL AIR DISC VALVES

Features

- Ceiling or wall mounting
- Smooth air flow control
- Easy mounting with a mounting spigot
- Equipped with a sealing ring
- Made of stainless steel



Overall dimensions and mounting

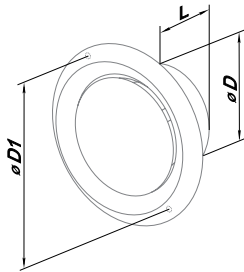

Model	Dimensions [mm]			Air pass [m ²]
	Ø D	Ø D1	Ø L	
VSR 100	97	118	52	0.0032
VSR 125	120	141	52	0.0057
VSR 150	145	162	62	0.009

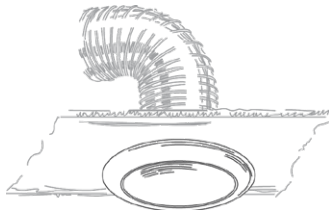

VPR

PLASTIC AIR DISC VALVES

Features

- o Ceiling or wall mounting
- o Smooth air flow control
- o Easy installation with a mounting spigot
- o Sealing ring



Overall dimensions and mounting

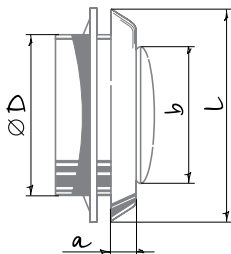

Model	Dimensions [mm]			Ø D	Air pass [m ²]
	a	b	l		
VPR 80	18	90	132	80	0...0.002
VPR 100	18	90	148	100	0...0.006
VPR 125	20	110	166	125	0...0.008
VPR 150	20	128	200	150	0...0.009
VPR 200	20	128	246	200	0...0.008

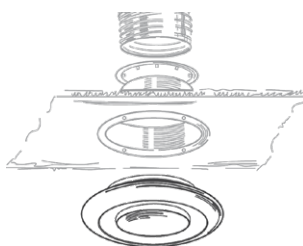

Technical data

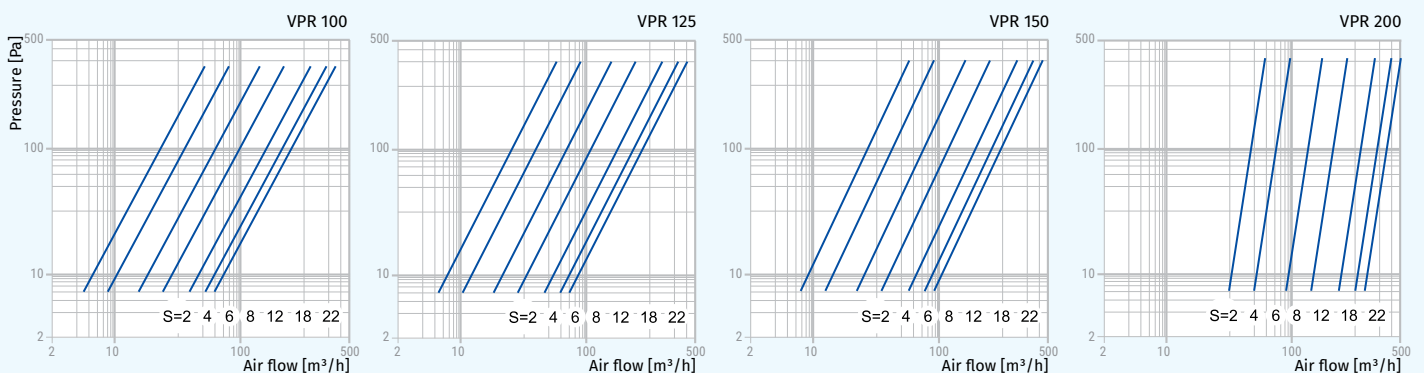

DECOR-A

ALUMINIUM DOOR GRILLES

Features

- For mounting in door leaves of bathrooms and kitchens
- Made of aluminium
- Available with white polymer coating (Model **Decor-A...white**)
- Minimum door leaf thickness is 34 mm
- Direct fixation to the door leaf with spacing lugs
- Easy maintenance



Overall dimensions

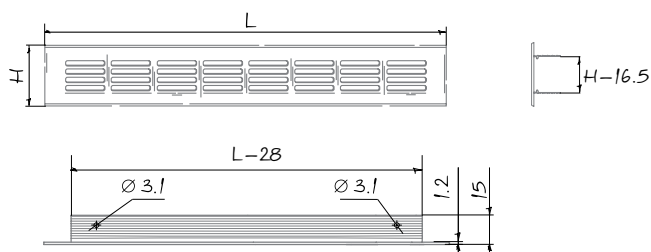

Model	Dimensions [mm]		Air pass [m ²]
	L	H	
Decor-A 400x60	400	60	0.0062
Decor-A 400x80	400	80	0.0093
Decor-A 400x100	400	100	0.012
Decor-A 500x60	500	60	0.0078
Decor-A 500x80	500	80	0.012
Decor-A 500x100	500	100	0.0156
Decor-A 600x60	600	60	0.0093
Decor-A 600x80	600	80	0.014
Decor-A 600x100	600	100	0.0186
Decor-A 800x60	800	60	0.012
Decor-A 800x80	800	80	0.0186
Decor-A 800x100	800	100	0.0248
Decor-A 1000x60	1000	60	0.016
Decor-A 1000x80	1000	80	0.0256
Decor-A 1000x100	1000	100	0.0326

DECOR T

PLASTIC DOOR GRILLES

Features

- o For mounting in door leaves of bathrooms and kitchens
- o Easy maintenance
- o Temperature- and UV-resistant antistatic plastic
- o Direct fixation to the door leaf with screws



Overall dimensions [mm]

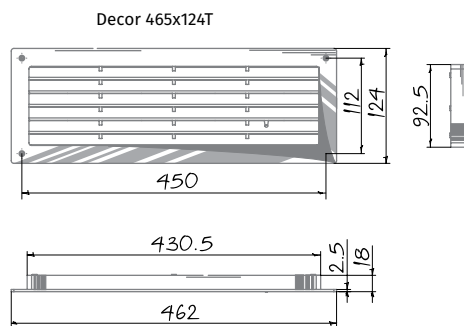
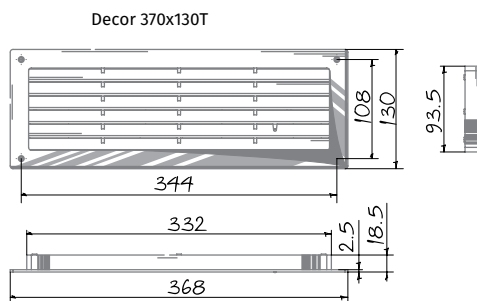

DECOR T-2

PLASTIC DOOR GRILLES

Features

- Two-element grilles for mounting in door leaves of bathrooms and kitchens
- Minimum door leaf thickness is 30 mm
- Easy maintenance
- Temperature- and UV-resistant antistatic plastic
- Direct fixation to the door leaf with screws



Overall dimensions [mm]

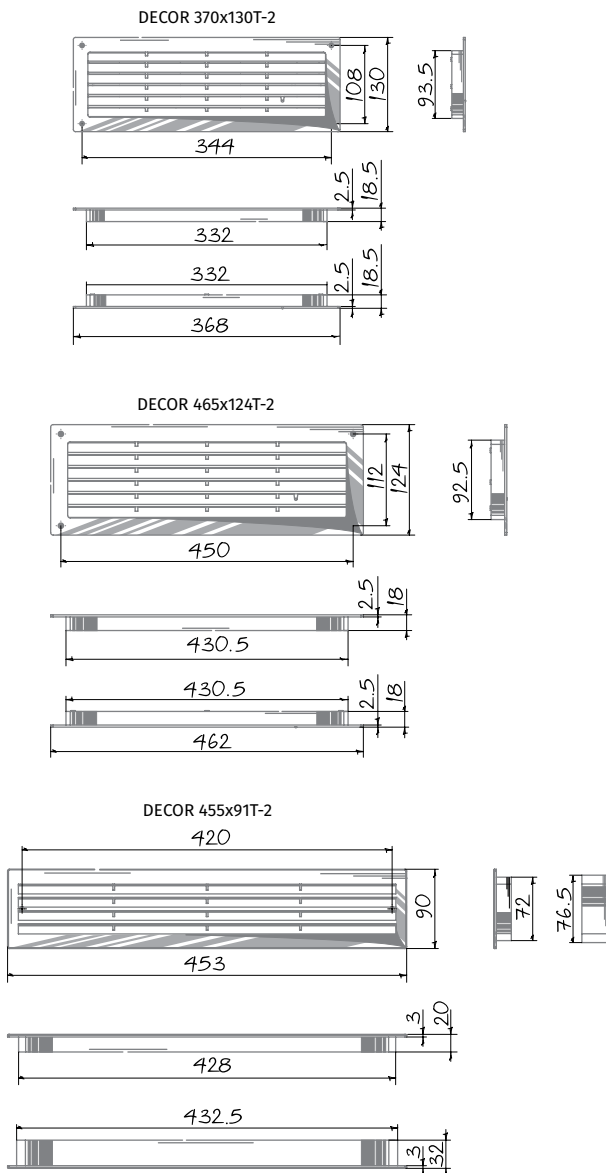

DECOR 380X104T-2

PLASTIC DOOR GRILLES

Features

- Two-element grilles for mounting in door leaves of bathrooms and kitchens
- The grille parts are connected through slots and fixed with screws
- Minimum door leaf thickness is 29 mm
- Easy maintenance
- Temperature- and UV-resistant antistatic plastic



Overall dimensions [mm]

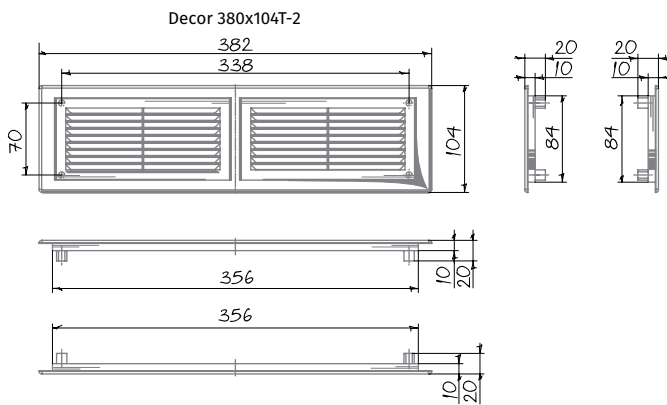

DECOR 60/47S-4

PLASTIC DOOR GRILLES

Features

- For mounting in door leaves of bathrooms and kitchens
- Suitable for installation in furniture for extra ventilation of internal space
- Temperature- and UV-resistant antistatic plastic
- Wide range of colours
- Fixing with mounting ribs or glue
- Supplied as a set (4 pcs)
- Equipped with a protecting insect screen (s)
- Easy maintenance



Overall dimensions and mounting

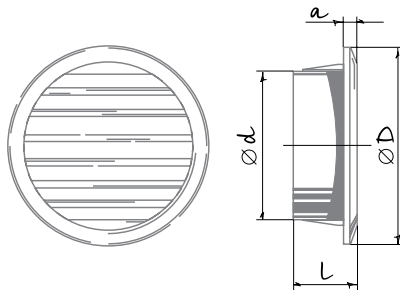

Model	Dimensions [mm]				Air pass [m ²]
	Ø D	Ø d	l	a	
Decor 60/47s-4	59	47	165	35	0.00078

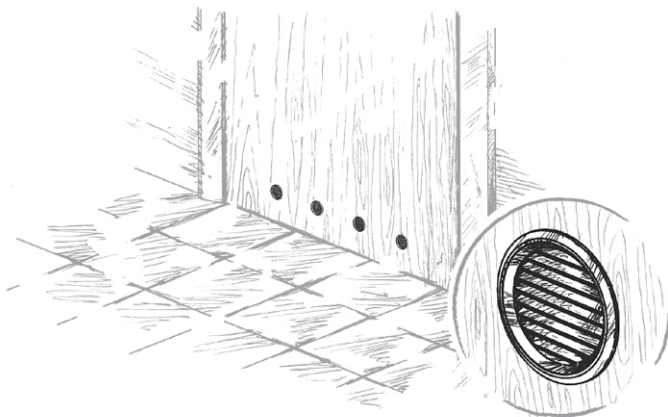

RT/RTV

ACCESS DOORS

Features

- Wall or ceiling mounting
- Suitable for use in humid areas
- High quality UV-resistant ABS plastic
- Versatile mounting enables left- and right-side opening
- Installation with mortar or glue
- Easy maintenance



Options

- RTV 15x30, RTV 25x40, RTV 30x50, RTV 30x60, RTV 40x50, RTV 40x60 – access doors with a lock for access control

Overall dimensions and mounting

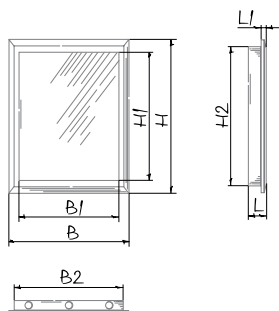

Model	Dimensions [mm]							
	H	B	H1	B1	H2	L1	L	B2
RT(V) 10x10	137	137	92	92	97	5	25	97
RT(V) 10x20	216	120	191	93	195	3	21	98
RT(V) 15x15	167	167	123	123	147	5	25	147
RT(V) 15x20	217	167	173	123	197	5	25	147
RT(V) 15x30	317	167	273	123	297	5	25	147
RT(V) 20x20	217	217	173	173	197	5	25	197
RT(V) 20x25	267	217	223	173	247	5	25	197
RT(V) 20x30	317	217	273	173	297	5	25	197
RT(V) 20x40	417	217	373	173	397	5	25	197
RT(V) 25x25	267	267	223	223	247	5	25	247
RT(V) 25x30	317	267	273	223	297	5	25	247
RT(V) 25x40	417	267	373	223	397	5	25	247
RT(V) 30x30	317	317	273	273	297	5	25	297
RT(V) 30x40	417	317	373	273	397	5	25	297
RT(V) 30x50	517	317	473	273	497	5	25	297
RT(V) 30x60	617	317	573	273	597	5	25	297
RT(V) 40x50	517	417	473	373	497	5	25	397
RT(V) 40x60	617	417	573	373	597	5	25	397



RTZ

ACCESS DOORS

Features

- Wall or ceiling mounting
- Suitable for use in humid areas
- High quality UV-resistant ABS plastic
- Versatile mounting enables left- and right-side opening
- Installation with mortar or glue
- Easy maintenance
- Specially treated surface for acrylic or water dispersion paints or wall papers



Overall dimensions and mounting

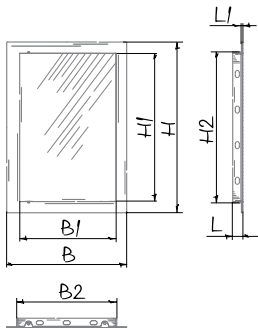

Model	Dimensions [mm]							
	H	B	H1	B1	H2	L1	L	B2
RTZ 20x30	336	236	291	189	297	3	20	197

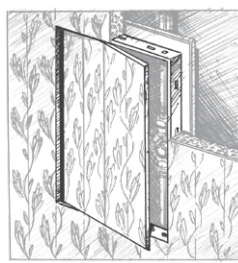
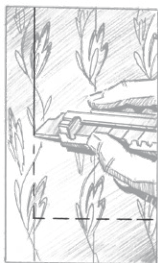
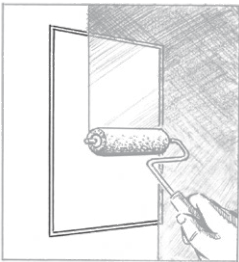

RTMG

ACCESS DOORS

Features

- Plastic handle for easy opening and closing of the door
- Wall mounting
- High quality steel with durable white polymer coating
- Special corrosion-resistant treatment
- Versatile mounting enables left- and right-side opening
- Installation with mortar or glue
- Easy maintenance



Overall dimensions and mounting

Model	Dimensions [mm]						
	H	B	H1	B2	H2	B1	L
RTMG 100x100	136.5	136.5	96.5	98.1	98.1	96.5	25
RTMG 150x150	186.5	186.5	146.5	148.1	148.1	146.5	25
RTMG 150x200	236.5	186.5	196.5	148.1	198.1	146.5	25
RTMG 150x250	286.5	186.5	246.5	148.1	248.1	146.5	25
RTMG 150x300	336.5	186.5	296.5	148.1	298.1	146.5	25
RTMG 200x200	236.5	236.5	196.5	198.1	198.1	196.5	25
RTMG 200x250	286.5	236.5	246.5	198.1	248.1	196.5	25
RTMG 200x300	336.5	236.5	296.5	198.1	298.1	196.5	25
RTMG 200x350	386.5	236.5	346.5	198.1	348.1	196.5	25
RTMG 200x400	436.5	236.5	396.5	198.1	398.1	196.5	25
RTMG 225x300	336.5	261.5	296.5	223.1	298.1	221.5	25
RTMG 225x590	626.5	261.5	586.5	223.1	588.1	221.5	25
RTMG 250x250	286.5	286.5	246.5	248.1	248.1	246.5	25
RTMG 250x300	336.5	286.5	296.5	248.1	298.1	246.5	25
RTMG 250x350	386.5	286.5	346.5	248.1	348.1	246.5	25
RTMG 250x400	436.5	286.5	396.5	248.1	398.1	246.5	25
RTMG 250x450	486.5	286.5	446.5	248.1	448.1	246.5	25
RTMG 300x200	236.5	336.5	196.5	298.1	198.1	296.5	25
RTMG 300x300	336.5	336.5	296.5	298.1	298.1	296.5	25
RTMG 300x400	436.5	336.5	396.5	298.1	398.1	296.5	25
RTMG 300x500	536.5	336.5	496.5	298.1	498.1	296.5	25
RTMG 300x600	636.5	336.5	596.5	298.1	598.1	296.5	25
RTMG 350x350	386.5	386.5	346.5	348.1	348.1	346.5	25
RTMG 400x400	436.5	436.5	396.5	398.1	398.1	396.5	25
RTMG 400x500	536.5	436.5	496.5	398.1	498.1	396.5	25
RTMG 400x600	636.5	436.5	596.5	398.1	598.1	396.5	25
RTMG 450x250	286.5	486.5	246.5	448.1	248.1	446.5	25
RTMG 450x450	486.5	486.5	446.5	448.1	448.1	446.5	25
RTMG 500x500	536.5	536.5	496.5	498.1	498.1	496.5	25
RTMG 500x600	636.5	536.5	596.5	498.1	598.1	496.5	25
RTMG 500x800	836.5	536.5	796.5	498.1	798.1	496.5	25
RTMG 555x555	591.5	591.5	551.5	553.1	553.1	551.5	25
RTMG 600x400	436.5	636.5	396.5	598.1	398.1	596.5	25
RTMG 600x600	636.5	636.5	596.5	598.1	598.1	596.5	25
RTMG 600x800	836.5	636.5	796.5	598.1	798.1	596.5	25

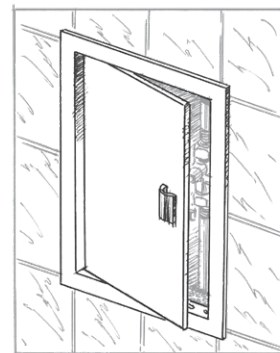
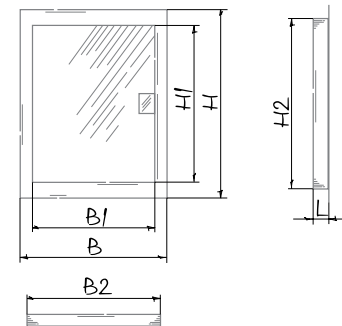

RTMV

ACCESS DOORS

Features

- o Access doors with a lock for access control
- o Wall mounting
- o High quality steel with durable white polymer coating
- o Special corrosion-resistant treatment
- o Versatile mounting enables left- and right-side opening
- o Installation with mortar or glue
- o Easy maintenance



Overall dimensions and mounting

Model	Dimensions [mm]						
	H	B	H1	B2	H2	B1	L
RTMV 100x100	136.5	136.5	96.5	98.1	98.1	96.5	25
RTMV 150x150	186.5	186.5	146.5	148.1	148.1	146.5	25
RTMV 150x200	236.5	186.5	196.5	148.1	198.1	146.5	25
RTMV 150x250	286.5	186.5	246.5	148.1	248.1	146.5	25
RTMV 150x300	336.5	186.5	296.5	148.1	298.1	146.5	25
RTMV 200x200	236.5	236.5	196.5	198.1	198.1	196.5	25
RTMV 200x250	286.5	236.5	246.5	198.1	248.1	196.5	25
RTMV 200x300	336.5	236.5	296.5	198.1	298.1	196.5	25
RTMV 200x350	386.5	236.5	346.5	198.1	348.1	196.5	25
RTMV 200x400	436.5	236.5	396.5	198.1	398.1	196.5	25
RTMV 200x500	536.5	236.5	496.5	198.1	498.1	196.5	25
RTMV 225x300	336.5	261.5	296.5	223.1	298.1	221.5	25
RTMV 225x590	626.5	261.5	586.5	223.1	588.1	221.5	25
RTMV 250x250	286.5	286.5	246.5	248.1	248.1	246.5	25
RTMV 250x300	336.5	286.5	296.5	248.1	298.1	246.5	25
RTMV 250x350	386.5	286.5	346.5	248.1	348.1	246.5	25
RTMV 250x400	436.5	286.5	396.5	248.1	398.1	246.5	25
RTMV 250x450	486.5	286.5	446.5	248.1	448.1	246.5	25
RTMV 300x200	236.5	336.5	196.5	298.1	198.1	296.5	25
RTMV 300x300	336.5	336.5	296.5	298.1	298.1	296.5	25
RTMV 300x400	436.5	336.5	396.5	298.1	398.1	296.5	25
RTMV 300x500	536.5	336.5	496.5	298.1	498.1	296.5	25
RTMV 300x600	636.5	336.5	596.5	298.1	598.1	296.5	25
RTMV 350x350	386.5	386.5	346.5	348.1	348.1	346.5	25
RTMV 400x400	436.5	436.5	396.5	398.1	398.1	396.5	25
RTMV 400x500	536.5	436.5	496.5	398.1	498.1	396.5	25
RTMV 400x600	636.5	436.5	596.5	398.1	598.1	396.5	25
RTMV 450x250	286.5	486.5	246.5	448.1	248.1	446.5	25
RTMV 450x450	486.5	486.5	446.5	448.1	448.1	446.5	25
RTMV 500x500	536.5	536.5	496.5	498.1	498.1	496.5	25
RTMV 500x600	636.5	536.5	596.5	498.1	598.1	496.5	25
RTMV 500x800	836.5	536.5	796.5	498.1	798.1	496.5	25
RTMV 555x555	591.5	591.5	551.5	553.1	553.1	551.5	25
RTMV 600x400	436.5	636.5	396.5	598.1	398.1	596.5	25
RTMV 600x600	636.5	636.5	596.5	598.1	598.1	596.5	25
RTMV 600x800	836.5	636.5	796.5	598.1	798.1	596.5	25

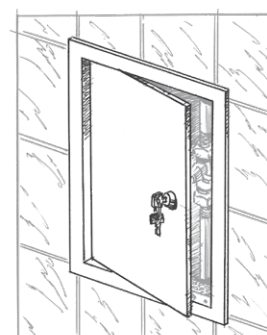
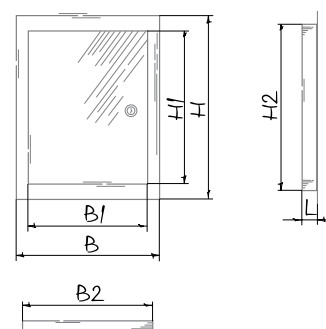

RT2

ACCESS DOORS

Features

- Wall or ceiling mounting
- Suitable for use in humid areas
- High quality UV-resistant ABS plastic
- Installation with mortar or glue
- Easy maintenance
- Wide access to utility lines due to swing door design



Overall dimensions and mounting

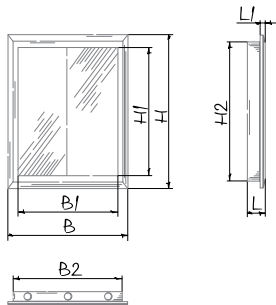

Model	Dimensions [mm]							
	H	B	H1	B1	H2	L1	L	B2
RT2 40x40	416	388	372	344	397	5	25	370

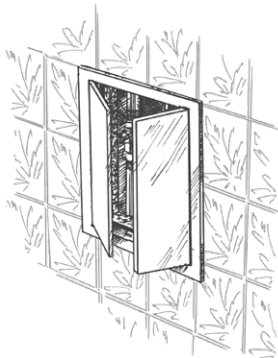

RTF

ACCESS DOORS

Features

- o Wall flush mounting
- o PVC frame has magnets and conceals tile-to-tile gap
- o Metal plate for fixing of ceramic tiles
- o Magnet fixation of plate to frame allows proper adjustment to tile position
- o Easy fixing of ceramic tiles to plate with glue
- o Suitable for use in humid areas
- o Easy mounting with spacing lugs
- o Easy maintenance
- o Designed for installation with wall tiles up to 9 mm thick



Overall dimensions and mounting

Model	Dimensions [mm]						
	B	H	B2	H2	B1	H1	L
RTF 150x150	156	156	145	145	153	153	30
RTF 150x200	156	206	145	195	153	203	30
RTF 150x250	156	256	145	245	153	253	30
RTF 150x300	156	306	145	295	153	303	30
RTF 200x200	206	206	195	195	203	203	30
RTF 200x250	206	256	195	245	203	253	30
RTF 200x300	206	306	195	295	203	303	30
RTF 200x350	206	356	195	345	203	353	30
RTF 200x400	206	406	195	395	203	403	30
RTF 200x450	206	456	195	445	203	453	30
RTF 200x500	206	506	195	495	203	503	30
RTF 250x250	256	256	245	245	253	253	30
RTF 250x300	256	306	245	295	253	303	30
RTF 250x350	256	356	245	345	253	353	30
RTF 250x400	256	406	245	395	253	403	30
RTF 300x300	306	306	295	295	303	303	30
RTF 300x350	306	356	295	345	303	353	30
RTF 300x400	306	406	295	395	303	403	30
RTF 300x450	306	456	295	445	303	453	30
RTF 300x500	306	506	295	495	303	503	30
RTF 400x400	406	406	395	395	403	403	30

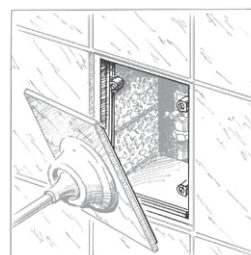
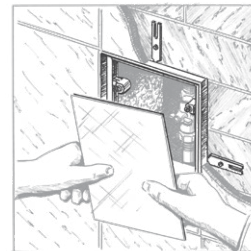
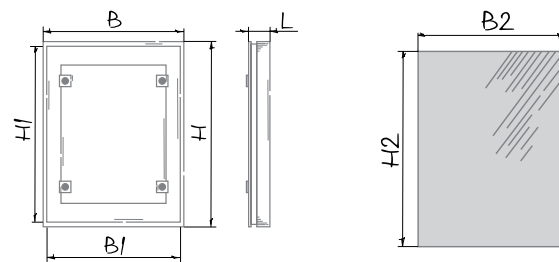

SGS E1

THYRISTOR SPEED CONTROLLERS

Features

- On/off switch and speed control for single-phase voltage controlled fans.
- Casing made of high-quality plastic.
- Glass sensor panel with an ON/OFF button and two speed control buttons.
- The adjustable speed is displayed with the LED indicator.
- Wall flush mounting.



Mounting

- Designed for wall mounting in a flush mounting box.

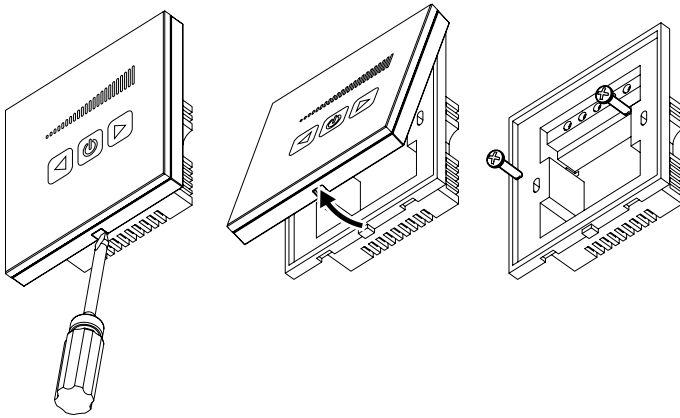

Wiring diagram

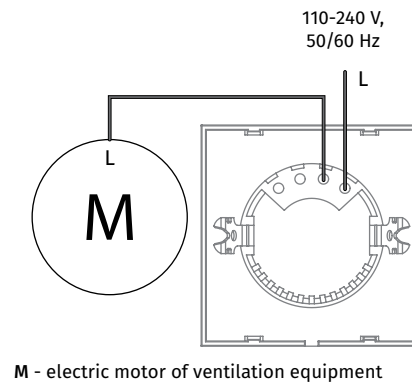

Overall dimensions [mm]

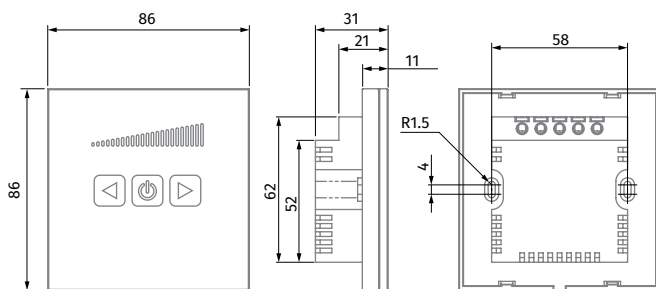

Technical data

Model	SGS E1
Voltage [V/Hz]	230/50 (60)
Max current load [A]	1
Cable cross section [mm ²]	from 0.35 up to 1
Temperature range [°C]	-10...+45
Operating humidity range [%]	from 5 up to 80 (no condensation)
Service life	100 000 operations
Weight [g]	138



CDT

THYRISTOR SPEED CONTROLLERS

Features

- o Expanded range of speed regulation for residential fans.
- o For switching fans on/off and for speed control of single-phase frequency controlled motors. For ventilation systems in various premises
- o The casing is made of high-quality plastic
- o Mounting junction box for wall flush mounting
- o Input circuit protected with a thermal fuse
- o Equipped with a transient filter
- o Mounting box EDR-E for wall surface mounting available upon separate order



Control

- o Switching on/off by the control knob.
- o Smooth speed control from minimum to maximum value. Minimum speed is set by a variable resistor on the control panel.
- o Several fans can be controlled from one unit provided that the total current consumption does not exceed the permissible controller current.
- o High efficiency and control accuracy.

Technical data

Model	CDT E0.5	CDT E1.8
Voltage [V/Hz]	1~230/50 (60)	1~230/50 (60)
Rated current [A]	0.5	1.8
Dimensions W × H × D [mm]	80 × 80 × 63	80 × 80 × 63
Max operating temperature [°C]	35	35



Mounting

- o Indoor wall flush mounting in a mounting box.
- o Suitable for installation in standard electric junction boxes.

Wiring diagram

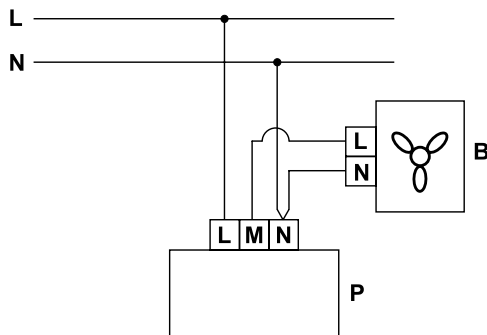

CDTE

THYRISTOR SPEED CONTROLLERS

Features

- Expanded range of speed regulation for residential fans.
- For switching fans on/off and for speed control of single-phase frequency controlled motors. For ventilation systems in various premises
- Casing made of high-quality plastic
- Surface box for mounting
- Input circuit protected with a thermal fuse
- Equipped with a transient filter



Control

- Switching on/off by control knob.
- Smooth speed control from minimum to maximum value. The minimum rotation speed is set by a variable resistor on the control panel.
- Several fans can be controlled from one unit provided that the total current consumption does not exceed the permissible controller current.
- Featured with high efficiency and control accuracy.

Technical data

Model	CDTE E0.5	CDTE E1.8
Voltage [V/Hz]	1~230/50 (60)	1~230/50 (60)
Rated current [A]	0.5	1.8
Dimensions W × H × D [mm]	80 × 80 × 63	80 × 80 × 63
Max operating temperature [°C]	35	35



Mounting

- Indoor wall mounting.

Wiring diagram

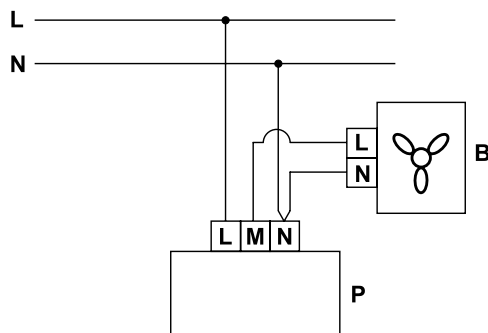

SGR-3/1

MULTI-SPEED SWITCHES

Features

- On/off switch and speed selection for multi-speed fans
- Casing made of high-quality plastic
- Glass sensor operating panel with three touch buttons for speed selection with light indication
- Wall flush mounting



Control

- Required speed is activated by touching the respectively marked speed button.
- The fan is turned off by touching the current speed button.

Mounting

- Designed for wall mounting in a flush mounting box.

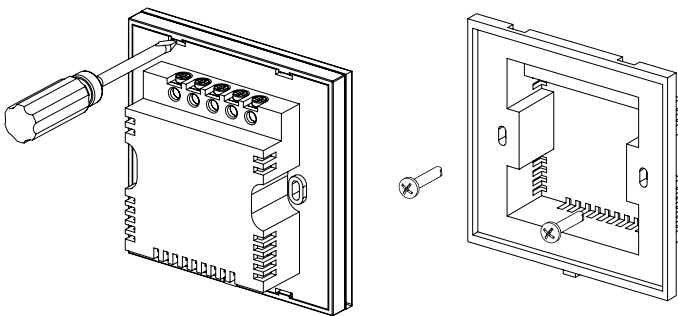

Wiring diagram

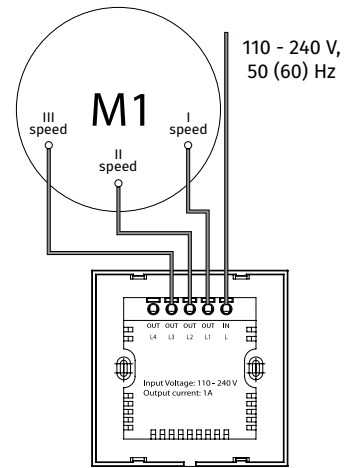

Overall dimensions [mm]

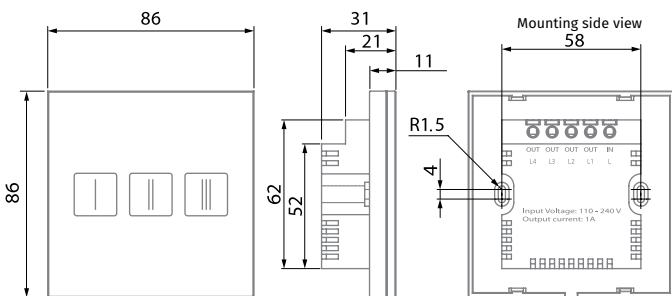

Technical data

Model	SGR-3/1
Voltage [V/Hz]	110-240/50 (60)
Max current load [A]	1
Number of speeds	3
Cable cross section [mm ²]	from 0.35 up to 1
Temperature range [°C]	-10...+45
Operating humidity range [%]	from 5 up to 80 (no condensation)
Service life	100 000 operations
Weight [g]	138



CDP-2/5 / CDP-3/5

MULTI-SPEED SWITCHES

Features

- On/off switch and speed switch for multi-speed fans
- Casing made of high-quality plastic
- Flush wall mounting



Control

- Switching of fan speed according to diagram 1 and switching of fan speed in parallel with switching the light in the room, diagram 2.

Mounting

- Indoor wall flush mounting in a mounting box.
- Suitable for installation in standard electric junction boxes.

Technical data

Model	CDP-2/5	CDP-3/5
Voltage [V/Hz]	1~230/50	1~230/50
Max current load [A]	3	3
Number of speeds	2	3
Dimensions W × H × D [mm]	88 × 88 × 51	88 × 88 × 51
Max operating temperature [°C]	40	40



Wiring diagram

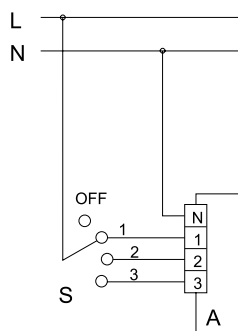

Diagram 1. The external switch S (CDP-3/5) switches the fan to one of three speeds and switches it off.

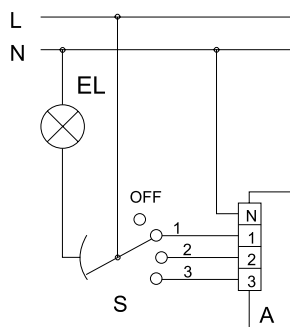

Diagram 2. The external switch S (CDP-3/5) switches the fan to one of three speeds and switches it off with parallel switching on/off the light in the room

CDP-2/10

MULTI-SPEED SWITCHES

Features

- Speed on/off switch and speed changeover for multi-speed fans
- Wall mounting in a flush mounting box
- Suitable for installation in standard electric junction boxes



Control

- Direct fan speed switching.

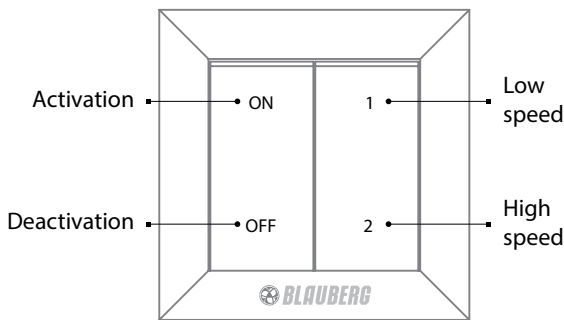

Wiring diagram

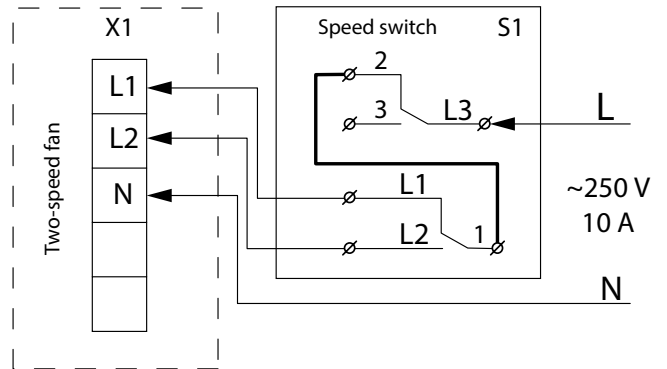

Overall dimensions [mm]

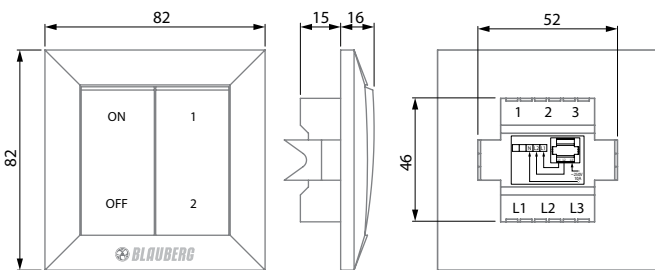

Technical data

Model	CDP-2/10
Voltage [V/Hz]	250/50 (60)
Max current load [A]	10
Cable cross section [mm ²]	from 0.35 up to 0.75
Temperature range [°C]	-10...+45
Operating humidity range [%]	from 5 up to 80 (no condensation)
Service life	100 000 switching operations
Weight [g]	98



CDPI-2(3) E5 / CDPE-2(3) E5

MULTI-SPEED SWITCHES

Features

- On/off switch and speed selection for multi-speed fans
- Casing made of high-quality plastic
- The casing includes an ON/OFF button, speed regulator and an operation light
- Wall flush mounting



Mounting

- **CDPI-2(3) E5:** Designed for wall mounting in a flush mounting box.
- **CDPE-2(3) E5:** Designed for wall surface mounting.

Wiring diagram

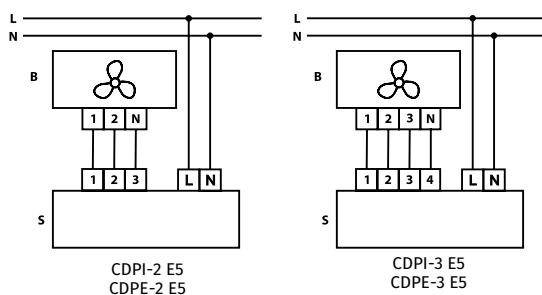

B - fan
S - switch

Technical data

Model	CDPI-2 E5	CDPI-3 E5
Voltage [V/Hz]	1~230/50	1~230/50
Rated current [A]	5	5
Number of speeds	2	3
Dimensions W × H × D [mm]	162 × 80 × 70	162 × 80 × 70
Max operating temperature [°C]	40	40
Weight [kg]	0.25	0.25



MCD 60/0.3

CONTROL UNITS FOR FANS

Features



- o Automatic regulation of residential fans.
- o Includes automatic control functions performed by a timer, humidity sensor, photo sensor or a motion sensor.
- o Control unit casing made of high-quality plastic.
- o Front panel equipped with light indicators. Display of control unit operation modes.
- o Equipped with a cord switch.



Modes and functions



RUN-OUT TIMER

Keeps the fan operating after switch-off within preset time period. Adjustable from 5 sec to 30 min.



INTERVAL TIMER

Switches the fan on/off. Operating cycle with time intervals from 5 sec to 30 min.



HUMIDITY SENSOR

Individually adjustable humidity set point. Switches the fan on when the humidity level exceeds the set point and switches the fan off when the humidity level drops to the set point.



PHOTO SENSOR

Automatically switches the fan on depending on the illumination level in the room due to the integrated photo switch. Two operation modes:

- o «Dark mode»: The control unit switches the fan on after light is turned off in the room. Operating period is adjustable from 5 sec up to 30 min. The photo sensor set point is adjustable from the control unit.
- o «Light mode»: The control unit switches the fan on after light is turned on in the room. After light is turned off the fan continues operating and is switched off by the run-out timer adjustable between 5 sec and 30 min. If the light in the room is on for more than 60 min the fan switches automatically off. The photo sensor set point is adjustable from the control unit.



MOTION SENSOR

Automatically switches the fan on in case of motion detection within the sensitivity area (operating distance 5 m, viewing angle 130°). The control unit switches the fan off after a preset time period from 5 sec to 30 min when no motion is detected.

Mounting

- o The control unit is designed for indoor wall surface installation close to the fan or remote installation.
- o For selecting the installation place consider motion sensor sensitivity area, furniture location and walking routes.

Control unit wiring diagram

- B – fan
- S1 – automatic circuit breaker
- S2 – external switch
- X – input terminal block BU

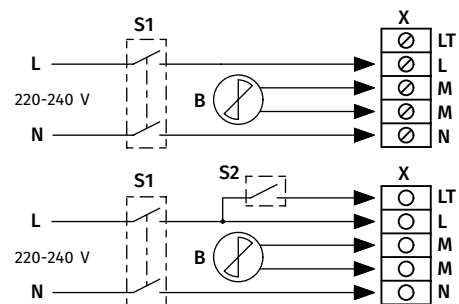

Technical data

Model	MCD 60/0.3
Voltage [V/Hz]	1~230/50
Max load power [W]	60
Max current load [A]	0.3
Dimensions W × H × D [mm]	151 × 46 × 27
Max operating temperature [°C]	+40



TS E10

ROOM THERMOSTAT

Features

- For comfortable indoor temperature conditions and control of ventilation, heating and air conditioning systems
- Casing made of high-quality plastic
- Temperature regulator on front panel and switch for operation mode selection on side panel
- Supplied in casing for wall mounting



Control

- Temperature regulation range from +10 up to +30 °C
- The regulator has two operating patterns:
 - the contacts close when a temperature set point is reached and the fan turns on
 - the contacts open when a temperature set point is reached and the fan turns off

Technical data

Model	TS E10
Voltage [V/Hz]	1~220-240/50 (60)
Dimensions W × H × D [mm]	84 × 84 × 35
Max operating temperature [°C]	40

Mounting

- Indoor wall surface installation in mounting box.
- Recommended installation height is 1.5 m above the floor level.
- Do not install the regulator close to windows, heating or cooling equipment.

Wiring diagram

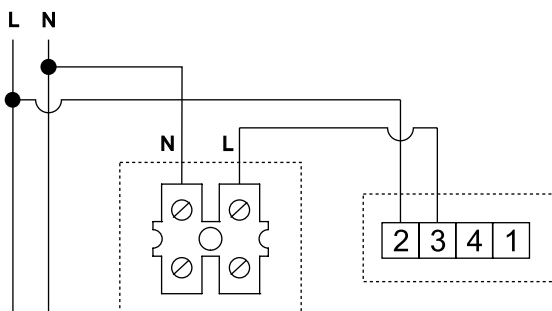

Fig.1. The fan operates until the temperature threshold set by the thermostat is reached

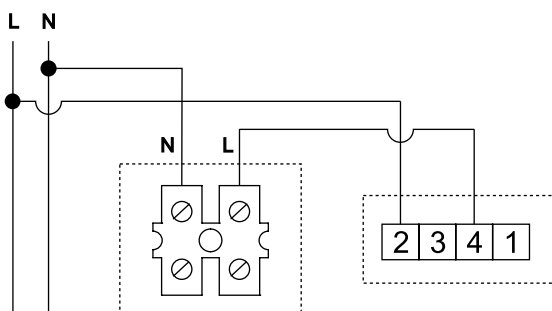

Fig.2. The fan turns on when the temperature threshold set by the thermostat is reached

MLC E2 / MLCD E2

ROOM TEMPERATURE REGULATORS

Features

- Automatic or manual temperature control in ventilation and air conditioning systems installed in various premises.
- Automatic regulation of heating/cooling rate.
- Control of fans, fancoil dampers and air heating units equipped with three-speed 230 V fans.
- Casing made of high-quality plastic.
- Equipped with a temperature sensor.
- LED display with illumination and control knobs incorporated in the front panel.
- The display shows: set and current indoor temperature; operation mode for cooling, heating or auto; fan speed.
- **MLCD E2** model is equipped with a remote control panel.



Control

- Control by control buttons on regulator casing or by remote control panel (**MLCD E2** model).
 - Manual or automatic regulation of indoor temperature. Fan speed high/medium/low. On automatic mode fan speed is regulated by indoor temperature.
- Automatic regulation of heating/cooling rate in «Night mode»:
- **Cooling mode:** 30 min after activation of the night mode the set temperature for the room automatically starts rising by 1 °C per hour within two hours and stays at this level. After 8 hours the timer turns off and the set temperature resets to the initial position.
 - **Heating mode:** 30 min after activation of the night mode the set temperature for the room automatically starts dropping by 1 °C per hour within three hours and stays at this level. After 8 hours the timer turns off and the set temperature resets to the initial position.
- The set control functions are saved when the thermal regulator is switched off.

Wiring diagram

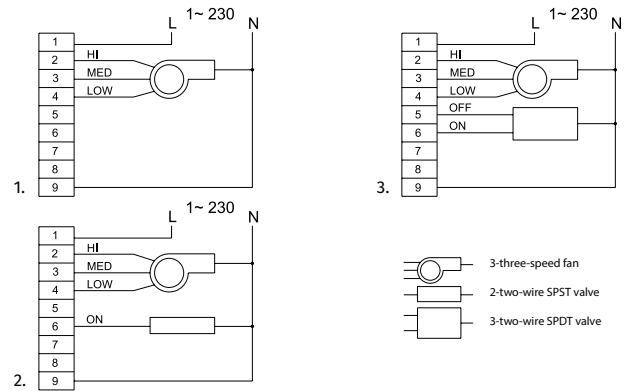

1. Ventilation with heating and cooling
2. Ventilation with heating and cooling three-wire system of SPDT valves
3. Ventilation with heating and cooling two-wire SPDT valve system

Mounting

- Indoor installation.
- Recommended installation height is 1.5 m above the floor level.
- Do not install the regulator close to windows, heating or cooling equipment.

Technical data

Model	MLC E2 / MLCD E2
Voltage [V/Hz]	1~230/50
Rated current [A]	2
Number of speeds	3
Temperature regulating range [°C]	+10...+30
Dimensions W × H × D [mm]	80 × 80 × 63
Max operating temperature [°C]	40
Remote control panel	no/yes



AT-25 220/12

STEP-DOWN TRANSFORMERS

Features

- Low-voltage step-down transformers are used to ensure safe 12 V/50 Hz power supply for residential fans with maximum motor power 16 W (25 VA) and maximum load current 2 A.
- Casing made of high-quality plastic.
- Supplied with external fuse blocks.
- The transformer has overload protection by a thermal fuse.



Mounting

- Indoor installation in areas not subjected to high temperature and humidity.
- Suitable for flush mounting behind the false ceiling or wall recess mounting provided that sufficient ventilation is ensured to prevent overheating.
- Do not install the transformer above heating equipment.

Wiring diagram

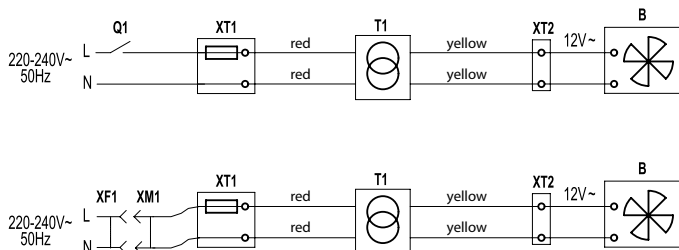

- Q1** – external switch integrated into the fixed wiring system
XT1 – input fuse block with a built-in thermal fuse in a protecting casing
XF1 – socket integrated into the fixed wiring system
XM1 – standard plug
T1 – transformer
XT2 – output fuse block for safe 12 V fan connection
B – fan with safe 12 V voltage

Technical data

Model	AT-25 220/12
Voltage [V/Hz]	1~230/50
Output voltage [V/Hz]	12/50
Max power [W]	16 (25 VA)
Max current load [A]	2
Dimensions W × H × D [mm]	
Transformer:	91 × 58 × 62
Fuse block:	110 × 40 × 40
Max operating temperature [°C]	40



ATK-25 220/12

STEP-DOWN TRANSFORMERS

Features

- Low-voltage step-down transformers are used to ensure safe 12 V/50 Hz power supply for residential fans with maximum motor power of 16 W (25 VA) and maximum load current of 2 A.
- Compact casing made of high-quality plastic.
- ATK-25 220/12 S** – the transformer is equipped with a pull cord switch and a light indicator.
- The transformer has overload protection by a thermal fuse.



Mounting

- Indoor installation in areas not subjected to high temperature and humidity.
- Designed for wall surface mounting. Provide free air circulation for cooling of internal circuits.
- Do not install the transformer above the heating equipment.

Technical data

Model	ATK-25 220/12
Voltage [V/Hz]	1~230/50
Output voltage [V/Hz]	12/50
Max power [W]	16 (25 VA)
Max current load [A]	2
Dimensions W × H × D [mm]	80 × 162 × 63
Max operating temperature [°C]	40



Wiring diagram

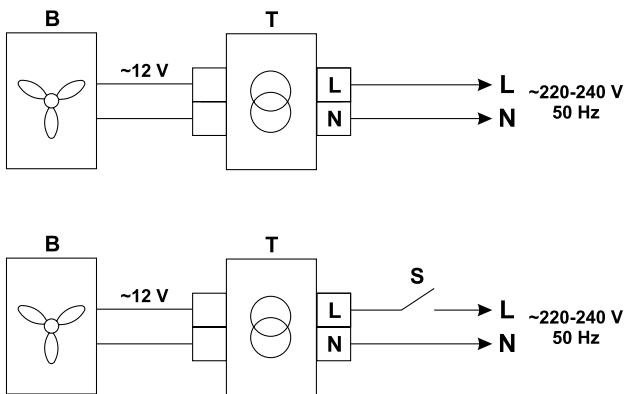

- B** – fan with safe 12 V voltage
- T** – protecting transformer
- S** – external switch

BLAUPLAST

ROUND PLASTIC DUCT SYSTEM

The **BlauPlast round duct system** is the best suitable solution for arranging supply and exhaust ventilation for residential or office premises. The BlauPlast system is used for connection of kitchen hoods, cowls, etc. to the general ventilation system



Features

- Smooth inner surface ensures low air resistance and low noise level in the system.
- Wide range of available components allows assembling ventilation system of any configuration and complexity.
- Exact compatibility of the components ensures perfect connection and integration into the ventilation system.
- Ergonomic fixing system and modular design shortens required installation and rework time.

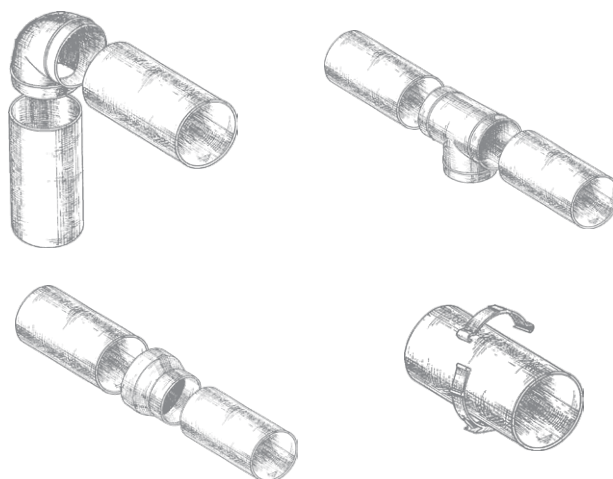
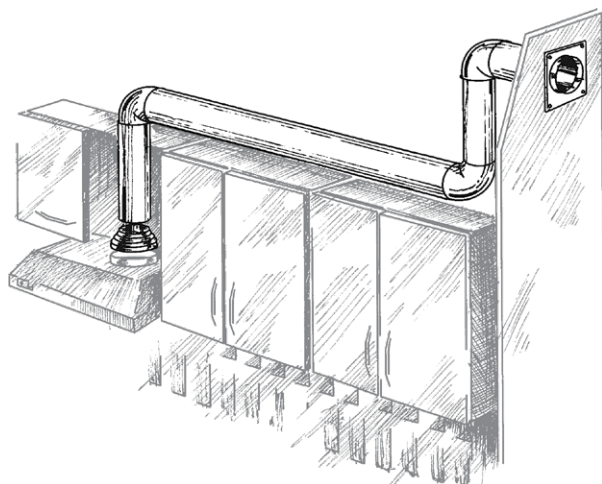

Round duct RR

- Made of white PVC

Model	Ø D1 (Inner) [mm]	Ø D2 (Outer) [mm]	L [m]
BlauPlast RR 100/0.35	100	103	0,35
BlauPlast RR 100/0.5	100	103	0,5
BlauPlast RR 100/1	100	103	1,0
BlauPlast RR 100/1.5	100	103	1,5
BlauPlast RR 100/2	100	103	2,0
BlauPlast RR 100/2.5	100	103	2,5
BlauPlast RR 125/0.35	125	128	0,35
BlauPlast RR 125/0.5	125	128	0,5
BlauPlast RR 125/1	125	128	1,0
BlauPlast RR 125/1.5	125	128	1,5
BlauPlast RR 125/2	125	128	2,0
BlauPlast RR 125/2.5	125	128	2,5
BlauPlast RR 150/0.35	150	153	0,35
BlauPlast RR 150/0.5	150	153	0,5
BlauPlast RR 150/1	150	153	1,0
BlauPlast RR 150/1.5	150	153	1,5
BlauPlast RR 150/2	150	153	2,0
BlauPlast RR 150/2.5	150	153	2,5
BlauPlast RR 200/0.35	200	203	0,35
BlauPlast RR 200/0.5	200	203	0,5
BlauPlast RR 200/1	200	203	1,0
BlauPlast RR 200/1.5	200	203	1,5
BlauPlast RR 200/2	200	203	2,0
BlauPlast RR 200/2.5	200	203	2,5

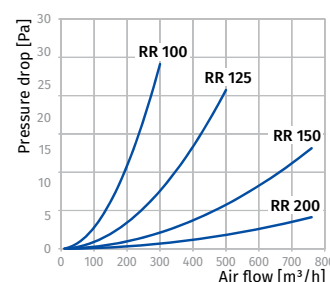
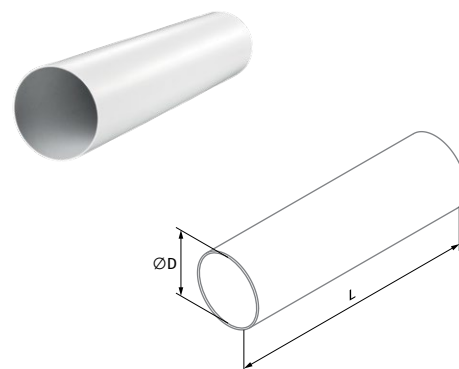

BLAUPLAST

ROUND PLASTIC DUCT SYSTEM

Round telescopic duct RTR

- Made of white PVC
- Extension piece

Model	∅ D1 (Inner) [mm]	∅ D1 (Outer) [mm]	∅ D2 (Inner) [mm]	∅ D2 (Outer) [mm]	L [m]
BlauPlast RTR 100/0.35-0.5	104	107	100	103	0.35-0.5
BlauPlast RTR 100/0.5-1	104	107	100	103	0.55
BlauPlast RTR 125/0.35-0.5	129	132	125	128	0.35-0.5
BlauPlast RTR 125/0.5-1	129	132	125	128	0.55
BlauPlast RTR 150/0.35-0.5	154	157	150	153	0.35-0.5
BlauPlast RTR 150/0.5-1	154	157	150	153	0.55

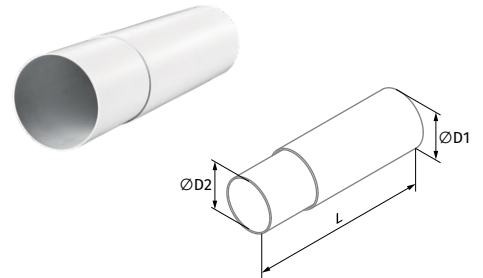

Round duct connector RV

- Direct connection with round air ducts RR
- Made of white plastic

Model	∅ D (Inner) [mm]	∅ D (Outer) [mm]	L [mm]
BlauPlast RV 100	96	100	62
BlauPlast RV 125	123	125	62
BlauPlast RV 150	148	150	62
BlauPlast RV 200	197	200	62

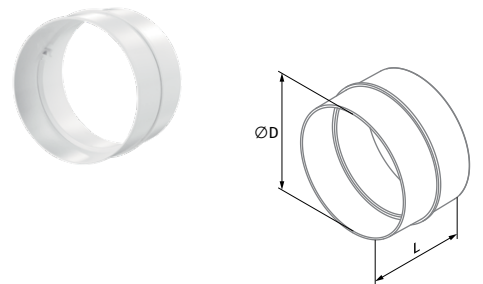

Connector with a backdraft damper for round ducts RVK

- Connection of air ducts of the same diameter
- Made of white plastic
- Equipped with a backdraft damper for back flow prevention
- Designed for direct installation into air ducts and equipped with a lock ring

Model	∅ D (Inner) [mm]	∅ D (Outer) [mm]	L [mm]
BlauPlast RVK 100	96	100	62
BlauPlast RVK 125	123	125	62
BlauPlast RVK 150	148	150	62
BlauPlast RVK 200	197	200	62

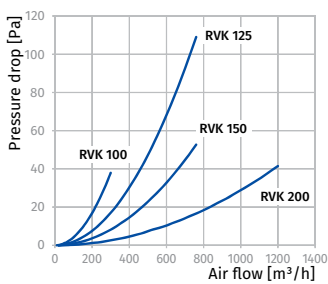
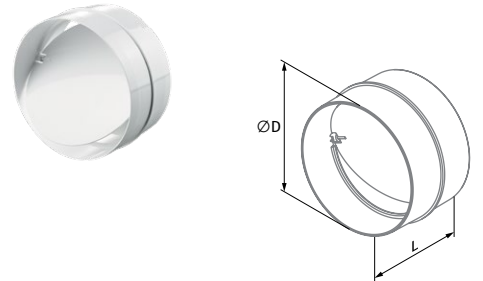

Flexible duct connector RSV

- Mounting with round ducts through an RV connector
- Made of white plastic

Model	∅ D (Inner) [mm]	∅ D (Outer) [mm]	L [mm]
BlauPlast RSV 100	100	103	60
BlauPlast RSV 125	125	128	60
BlauPlast RSV 150	150	153	60
BlauPlast RSV 200	200	204	60

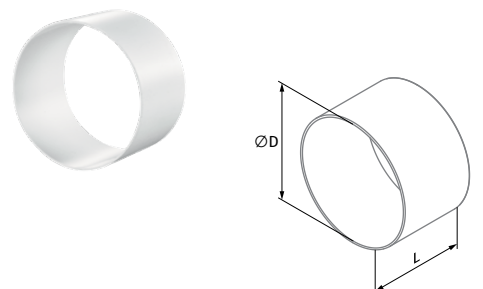

BLAUPLAST

ROUND PLASTIC DUCT SYSTEM

Flexible round duct connector RSVN

- Connection of flexible round ducts.
- Made of white PVC.
- Cover the connector with air duct and fix it with clamps.

Model	Ø D [mm]	L [mm]
BlauPlast RSVN 100	100	77
BlauPlast RSVN 125	125	77

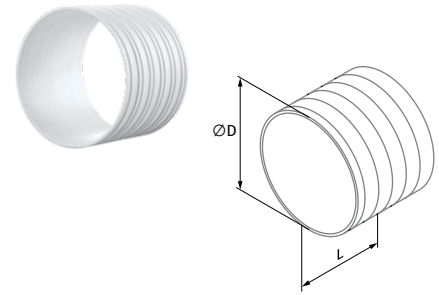

Round duct connector with a condensation trap RVC

- Connection of various diameter air ducts.
- Prevents small amounts of condensate from dripping down the air duct.
- Made of white plastic.

Model	Ø D [mm]	Ø D1 [mm]	L [mm]
BlauPlast RVC 100	100	129	136
BlauPlast RVC 125	125	154	136
BlauPlast RVC 150	150	209	153

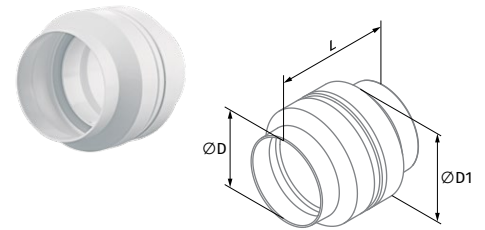

Bend 90° RB

- Direct connection with round RR ducts
- Made of white plastic

Model	Ø D (Inner) [mm]	Ø D (Outer) [mm]	H [mm]
BlauPlast RB 100/90°	97	100	137
BlauPlast RB 125/90°	122	125	164
BlauPlast RB 150/90°	147	150	189

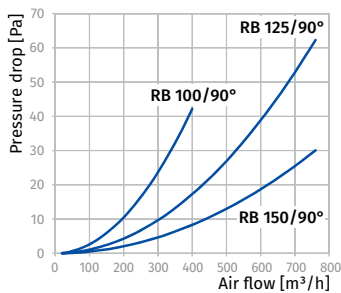
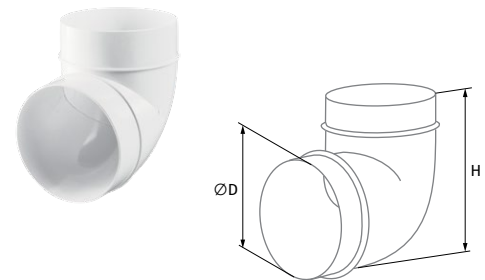

Bend 45° RB

- Connection to RR round air ducts at 45°
- Made of white plastic

Model	Ø D (Inner) [mm]	Ø D (Outer) [mm]	a [mm]	b [mm]	c [mm]
BlauPlast RB 100/45°	100	103	125	30	129
BlauPlast RB 125/45°	125	128	157	40	162
BlauPlast RB 150/45°	150	153	164	30	164

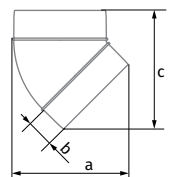
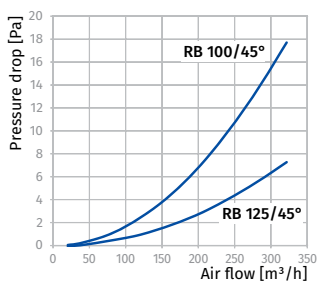

BLAUPLAST

ROUND PLASTIC DUCT SYSTEM

Round duct holder RH

- Air duct mounting to a flat surface
- Made of white plastic
- Fixing to surface with screws

Model	∅ D (Inner) [mm]	H [mm]
BlauPlast RH 100	103	113
BlauPlast RH 125	128	138
BlauPlast RH 150	153	163
BlauPlast RH 200	203	213

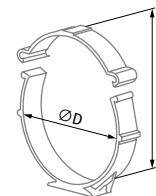

Round duct connector with plate RVP

- Air duct mounting
- Made of white plastic
- Wall or ceiling mounting with screws

Model	∅ D (Inner) [mm]	∅ D (Outer) [mm]	a [mm]	b [mm]
BlauPlast RVP 100	100	103	150 × 150	134 × 134
BlauPlast RVP 125	125	128	170 × 170	154 × 154
BlauPlast RVP 150	150	153	204 × 204	188 × 188
BlauPlast RVP 200	200	203	250 × 250	230 × 230

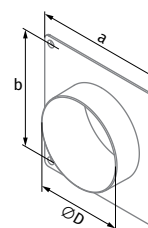

Round duct connector with a plate and a gravity backdraft damper RVPK

- Air duct mounting
- Made of white plastic
- Wall or ceiling mounting with screws
- Damper prevents air back drafting

Model	∅ D (Inner) [mm]	∅ D (Outer) [mm]	a [mm]	b [mm]
BlauPlast RVPK 100	100	103	150 × 150	134 × 134
BlauPlast RVPK 125	125	128	170 × 170	154 × 154
BlauPlast RVPK 150	150	153	204 × 204	188 × 188
BlauPlast RVPK 200	200	203	250 × 250	230 × 230

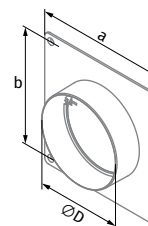

Wall plate for round ducts WP

- Connection of air ducts to ventilation shafts
- Decoration of mounting openings
- Made of white plastic
- Screw fixing to wall

Model	∅ D [mm]	a [mm]	b [mm]
BlauPlast WP 100	103	150 × 150	134 × 134
BlauPlast WP 125	128	170 × 170	154 × 154
BlauPlast WP 150	151	204 × 204	188 × 188
BlauPlast WP 200	204	250 × 250	230 × 230

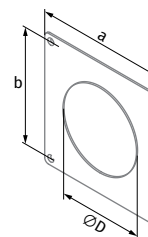

BLAUPLAST

ROUND PLASTIC DUCT SYSTEM

Round duct reducer RS

- For connection to round air ducts **RR** of various diameter
- Made of white plastic

Model	∅ D1 (Inner) [mm]	∅ D1 (Outer) [mm]	∅ D2 (Inner) [mm]	∅ D2 (Outer) [mm]	L [mm]
BlauPlast RS 80/100	76	80	100	103	60
BlauPlast RS 100/110	96	100	110	113	42
BlauPlast RS 100/125	96	100	125	129	60
BlauPlast RS 100/150	96	99	146	150	70
BlauPlast RS 100/120	98.5	99	120	124	60
BlauPlast RS 125/150	121	125	150	154	60
BlauPlast RS 150/200	146	150	200	204	71

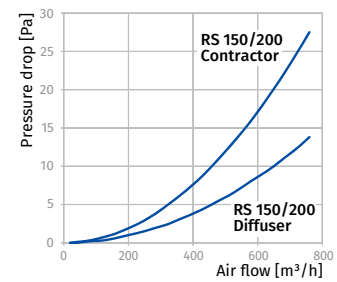
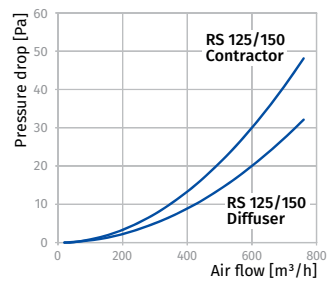
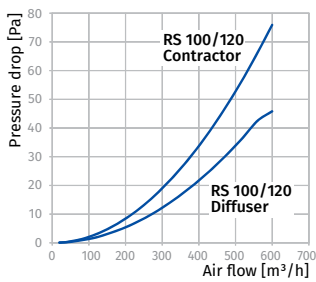
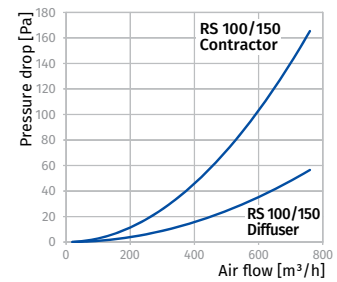
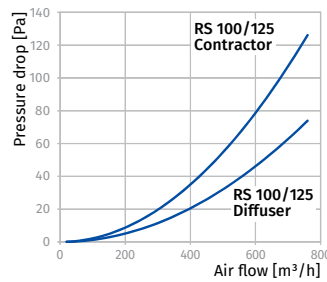
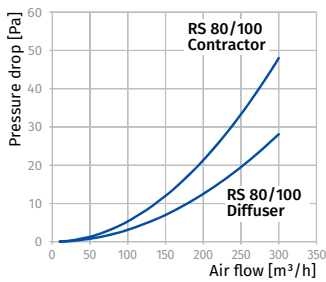
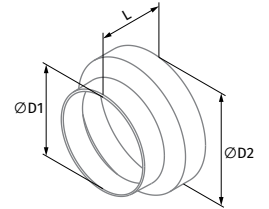

Reducer RS

- Connection of ∅ 120 and 125 mm round air ducts
- Made of white plastic

Model	∅ D1 (Inner) [mm]	∅ D1 (Outer) [mm]	∅ D2 (Inner) [mm]	∅ D2 (Outer) [mm]	L [mm]
BlauPlast RS 120/125	115	119	129	125	42

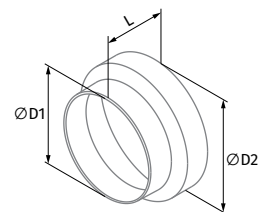
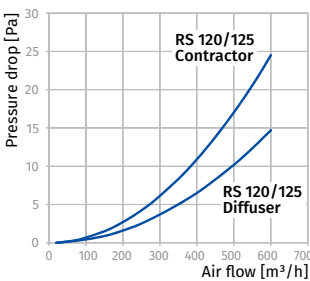

T-joint for round ducts RRT

- Connection of same diameter round ducts and integration into complex ventilation systems
- Made of white plastic
- Connection of same diameter three round ducts at 90°

Model	∅ D (Inner) [mm]	∅ D (Outer) [mm]	L [mm]	a [mm]
BlauPlast RRT 100	97	100	173	30
BlauPlast RRT 125	122	125	198	30
BlauPlast RRT 150	147	150	223	30

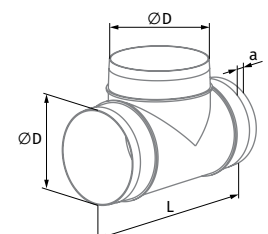

BLAUPLAST

ROUND PLASTIC DUCT SYSTEM

Round step reducer RS

- For connection of various diameter round air ducts RR
- Made of white plastic

Model	Ø D1 [mm]		Ø D2 [mm]		Ø D3 [mm]		Ø D4 [mm]		Ø D5 [mm]		L [mm]
	Inner	Outer	Inner	Outer	Inner	Outer	Inner	Outer	Inner	Outer	
BlauPlast RS 80-150	75	80	95	100	115	120	120	125	145	150	125

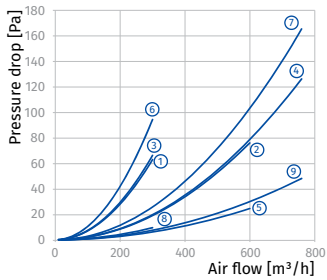

- Contractor**
- ① 120-80
 - ② 120-100
 - ③ 125-80
 - ④ 125-100
 - ⑤ 125-120
 - ⑥ 150-80
 - ⑦ 150-100
 - ⑧ 150-120
 - ⑨ 150-125

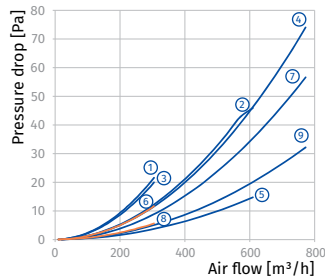

- Diffuser**
- ① 120-80
 - ② 120-100
 - ③ 125-80
 - ④ 125-100
 - ⑤ 125-120
 - ⑥ 150-80
 - ⑦ 150-100
 - ⑧ 150-120
 - ⑨ 150-125

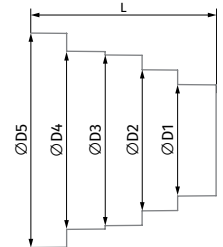

Eccentric reducer RSE

- Connection of round ducts
- Made of white plastic

Model	Ø D1 [mm]	Ø D2 [mm]	Ø D3 [mm]	Ø D4 [mm]	L [mm]
BlauPlast RSE 100/125	125	120	110	100	90
BlauPlast RSE 125/150	150	125	120	-	95

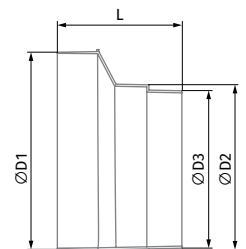
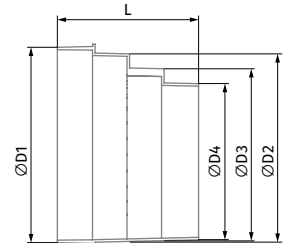
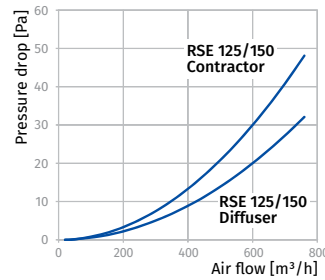
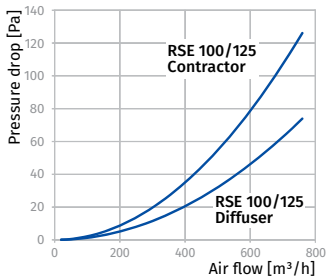

Round flexible duct connector RVF

- Connection of flexible ducts with plastic system components
- Made of white plastic
- Connection to flexible air ducts without clamps
- **BlauPlast RVF 100:** Flexible spiral seam duct is connected to one side and the other side is connected to a Ø 100 mm spigot
- **BlauPlast RVFI 100:** Flexible spiral seam duct is connected to one side and the other side is connected to a Ø 100 mm air duct
- Left or right (R) thread. Right thread connectors are used with BlauFlex air ducts

Model	Ø D [mm]	Ø D1 [mm]	Ø D2 [mm]	L [mm]	L1 [mm]
BlauPlast RVF 100	100	90	110	60	30
BlauPlast RVFI 100	100	90	110	60	30

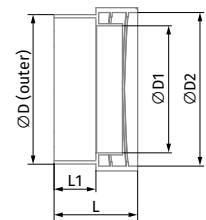
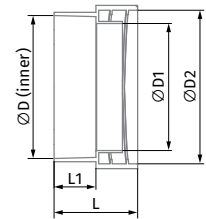

BLAUPLAST

FLAT PLASTIC DUCT SYSTEM

The BlauPlast flat plastic duct system is the best suitable solution for arranging supply and exhaust ventilation for residential or office premises. The BlauPlast system is used for connection of kitchen hoods, cowls, etc. to the general ventilation system

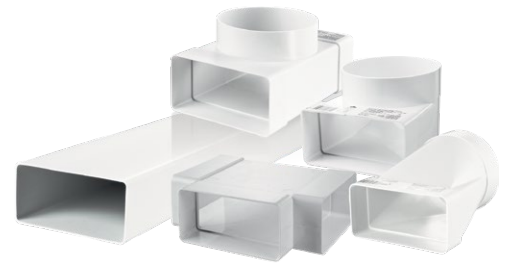

Features

- Smooth inner surface ensures low air resistance and low noise level in the system.
- Wide range of available components allows assembling ventilation of any configuration and complexity.
- Exact matching of the components ensures perfect connection and integration into the ventilation system.
- Ergonomic fixing system and modular design shortens required installation and rework time.
- Versatile connectors and reducers provide combination of flat and round ventilation ductworks.
- Compact sizes make the system suitable for installation in brand new or newly refurbished premises.

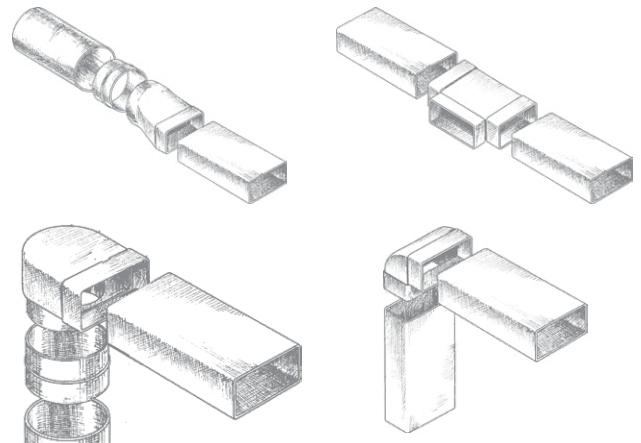
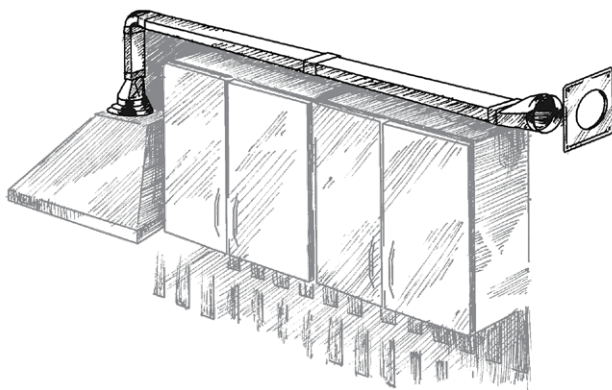

Flat air duct FK

- Made of white PVC

Model	H × W (Inner) [mm]	H × W (Outer) [mm]	L [m]
BlauPlast FK 110x55/0.35	52 × 107	55 × 110	0.35
BlauPlast FK 110x55/0.5	52 × 107	55 × 110	0.5
BlauPlast FK 110x55/1	52 × 107	55 × 110	1.0
BlauPlast FK 110x55/1.5	52 × 107	55 × 110	1.5
BlauPlast FK 110x55/2.0	52 × 107	55 × 110	2.0
BlauPlast FK 110x55/2.5	52 × 107	55 × 110	2.5
BlauPlast FK 204x60/0.35	57 × 200	60 × 204	0.35
BlauPlast FK 204x60/0.5	57 × 200	60 × 204	0.5
BlauPlast FK 204x60/1	57 × 200	60 × 204	1.0
BlauPlast FK 204x60/1.5	57 × 200	60 × 204	1.5
BlauPlast FK 204x60/2.0	57 × 200	60 × 204	2.0
BlauPlast FK 204x60/2.5	57 × 200	60 × 204	2.5
BlauPlast FK 220x55/0.35	52 × 217	55 × 220	0.35
BlauPlast FK 220x55/0.5	52 × 217	55 × 220	0.5
BlauPlast FK 220x55/1	52 × 217	55 × 220	1.0
BlauPlast FK 220x55/1.5	52 × 217	55 × 220	1.5
BlauPlast FK 220x55/2	52 × 217	55 × 220	2.0
BlauPlast FK 220x55/2.5	52 × 217	55 × 220	2.5
BlauPlast FK 220x90/0.35	86 × 216	90 × 220	0.35
BlauPlast FK 220x90/0.5	86 × 216	90 × 220	0.5
BlauPlast FK 220x90/1	86 × 216	90 × 220	1.0
BlauPlast FK 220x90/1.5	86 × 216	90 × 220	1.5
BlauPlast FK 220x90/2.0	86 × 216	90 × 220	2.0
BlauPlast FK 220x90/2.5	86 × 216	90 × 220	2.5

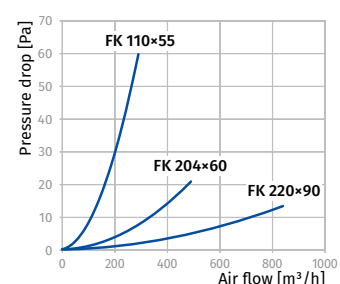
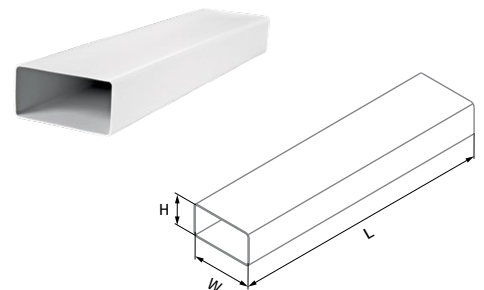

Data for 1-meter-long air duct section

BLAUPLAST

FLAT PLASTIC DUCT SYSTEM

Flat air duct connector FKV

- Direct connection with the **FK** flat air ducts
- Made of white plastic

Model	H × W (Inner) [mm]	H × W (Outer) [mm]	L [mm]
BlauPlast FKV 110x55	56 × 110	59 × 114	66
BlauPlast FKV 204x60	60 × 204	65 × 209	62
BlauPlast FKV 220x55	55 × 220	60 × 225	62
BlauPlast FKV 220x90	90 × 220	95 × 225	62

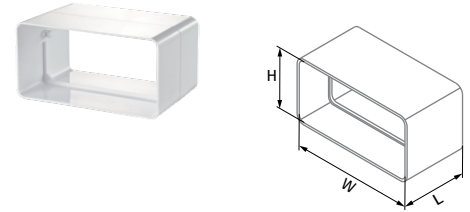

Bend US-90°

- Direct connection to **FK** flat air ducts and **RR** round air ducts
- Made of white plastic

Model	∅ D (Inner) [mm]	∅ D (Outer) [mm]	H × W (Inner) [mm]	H × W (Outer) [mm]	H1 [mm]	L [mm]
BlauPlast US-90° 100/110x55*	100	103	55 × 110	58 × 113	87	138
BlauPlast US-90° 100/204x60	97	100	60 × 204	64 × 208	92	164
BlauPlast US-90° 100/220x55	96	99	55 × 220	60 × 226	88	175
BlauPlast US-90° 125/204x60	122	125	60 × 204	64 × 208	92	220
BlauPlast US-90° 125/220x55	121	124	55 × 220	60 × 226	88	175
BlauPlast US-90° 125/220x90	147	150	90 × 220	94 × 226	120	230
BlauPlast US-90° 150/204x60	147	150	60 × 204	64 × 208	92	220
BlauPlast US-90° 150/220x90	146	150	90 × 220	94 × 226	120	230

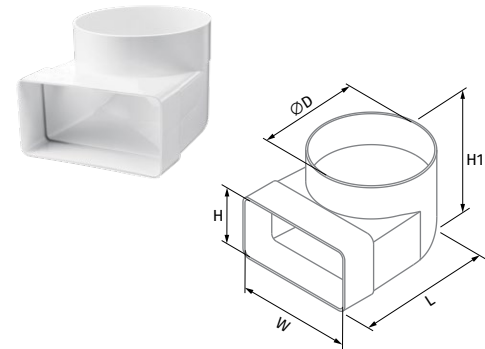

*The BlauPlast US-90° 100/110x55 is connected to the **RR** round air duct via the **RV** connector

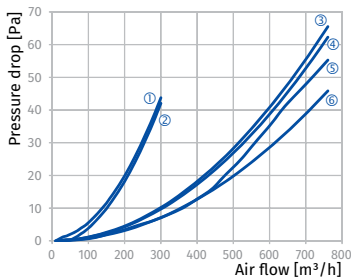

- ① US-90° 100/110x55
- ② US-90° 100/204x60
- ③ US-90° 125/204x60
- ④ US-90° 150/204x60
- ⑤ US-90° 150/220x90
- ⑥ US-90° 125/220x90

90° connecting bend for flat and round flexible ducts USN-90°

- Supply and exhaust ventilation of various premises.
- Connection of rigid flat to round flexible ducts at 90°.
- Made of white plastic.

Model	∅ D [mm]	W × H (Inner) [mm]	W × H (Outer) [mm]	H1 [mm]	L [mm]
BlauPlast USN-90° 100/220x55	100	220 × 55	226 × 60	134	175
BlauPlast USN-90° 125/220x55	125	220 × 55	226 × 60	134	175

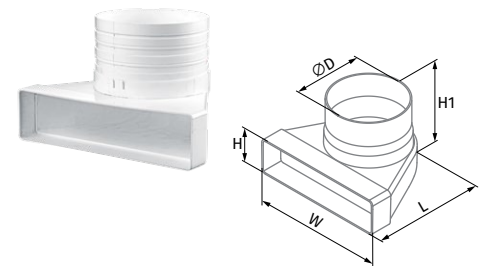

Versatile flat angular connector FKVU

- Angular connection of flat ducts **FK**
- Made of white plastic
- Turning point angle from 3° to 48°
- Depending on selected turning angle one connector side is cut out. Connection to the flat duct through a connector of matching sized
- On spigot side direct connection to flat duct of respective size

Model	a [mm]	b [mm]	c [mm]
BlauPlast FKVU 110x55	190	143	55 × 110
BlauPlast FKVU 204x60	286	247	60 × 204

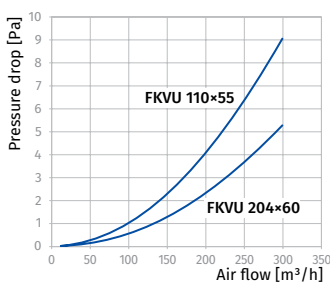
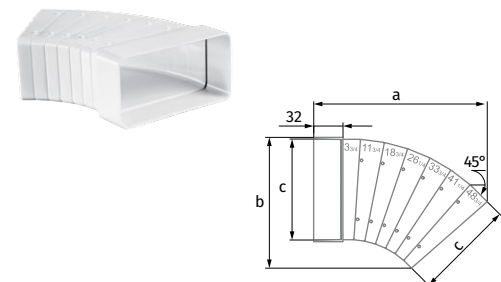

BLAUPLAST

FLAT PLASTIC DUCT SYSTEM

Vertical connecting bend FKW

- Direct vertical connection with the **FK** flat duct
- Made of white plastic

Model	H × W (Inner) [mm]	H × W (Outer) [mm]	L [mm]
BlauPlast FKW 110x55	55 × 110	58 × 113	89
BlauPlast FKW 204x60	60 × 204	64 × 208	103
BlauPlast FKW 220x55	55 × 220	62 × 225	95
BlauPlast FKW 220x90	90 × 220	94 × 224	130

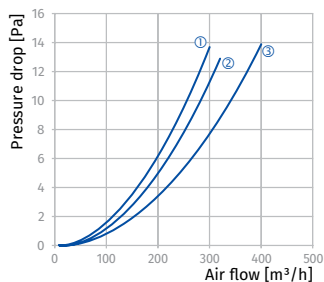

- ① FKW 110x55
- ② FKW 220x90
- ③ FKW 204x60

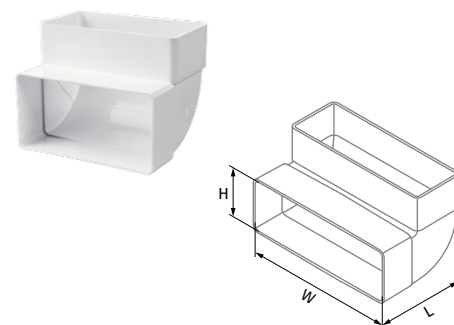

Horizontal connecting bend FKB

- Horizontal connection with the **FK** flat duct
- Made of white plastic

Model	H × W (Inner) [mm]	L [mm]
BlauPlast FKB 110x55	55 × 110	143
BlauPlast FKB 204x60	60 × 204	238
BlauPlast FKB 220x55	55 × 220	262
BlauPlast FKB 220x90	90 × 220	262

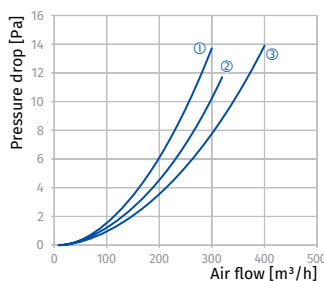

- ① FKB 110x55
- ② FKB 204x60
- ③ FKB 220x90

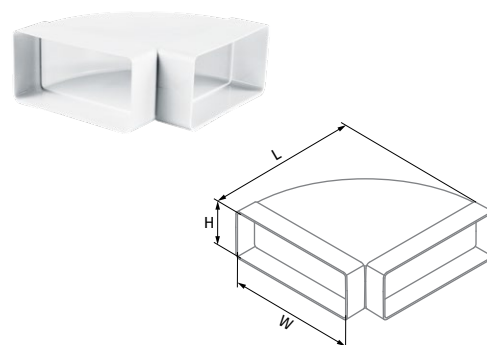

Connector UBS

- Direct connection with the flat **FK** air duct, connection with the round **RR** air duct through the **RV** connector
- Made of white plastic

Model	∅ D (Inner) [mm]	∅ D (Outer) [mm]	H × W (Inner) [mm]	L [mm]
BlauPlast UBS 100/110x55	100	103	55 × 110	137
BlauPlast UBS 125/220x55	121	124	55 × 220	165
BlauPlast UBS 125/204x60	125	128	60 × 204	150
BlauPlast UBS 150/220x90	146	150	90 × 220	165

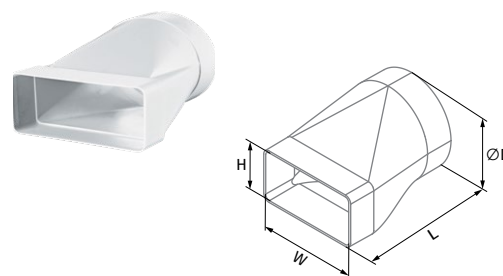
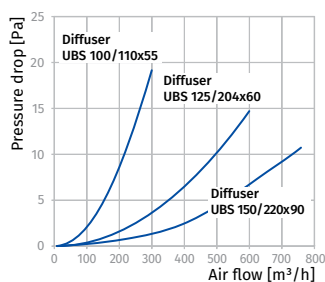
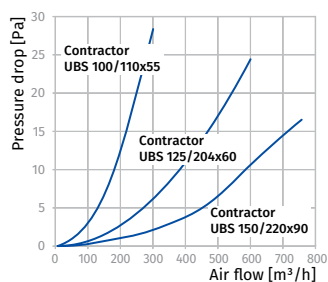

BLAUPLAST

FLAT PLASTIC DUCT SYSTEM

Flat duct T-connector FKT

- Direct horizontal connection with the **FK** flat duct
- Made of white plastic

Model	H × L (Inner) [mm]	L1 × W [mm]
BlauPlast FKT 110x55	55 × 110	174 × 144
BlauPlast FKT 204x60	60 × 204	288 × 248
BlauPlast FKT 220x90	90 × 220	296 × 261

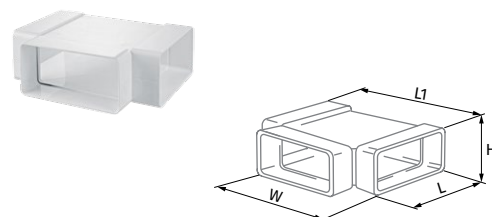

Flat to round connector FRT

- Direct connection with the flat **FK** air duct, connection with the round **RR** air duct through the **RV** connector
- Made of white plastic

Model	∅ D (Inner) [mm]	∅ D (Outer) [mm]	H × W (Inner) [mm]	L [mm]
BlauPlast FRT 100/110x55	100	103	55 × 110	172

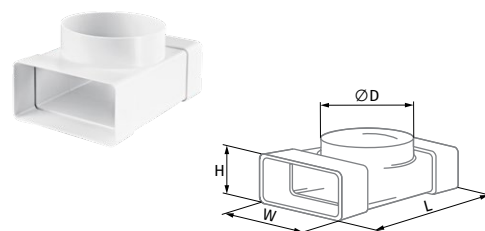

Flat duct holder FKH

- Mounting of the **FK** flat air duct to a surface
- Made of white plastic
- Fixing with screws

Model	H × W [mm]	L [mm]	c [mm]
BlauPlast FKH 110x55	59 × 114	32	74
BlauPlast FKH 204x60	65 × 209	40	169
BlauPlast FKH 220x55	55 × 222	20	144
BlauPlast FKH 220x90	95 × 227	20	175

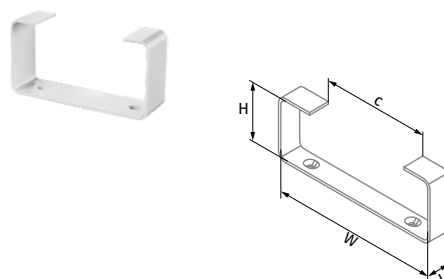

Flat duct connector with damper FKVK

- Connection of same sized flat ducts **FK**
- Made of white plastic
- Designed for installation into air ducts and equipped with a lock ring for easy jointing
- Equipped with a backdraft damper for back flow prevention

Model	H × W (Inner) [mm]	H × W (Outer) [mm]	L [mm]
BlauPlast FKVK 110x55	56 × 110	59 × 114	66
BlauPlast FKVK 204x60	60 × 204	65 × 209	62
BlauPlast FKVK 220x90	90 × 220	95 × 225	62

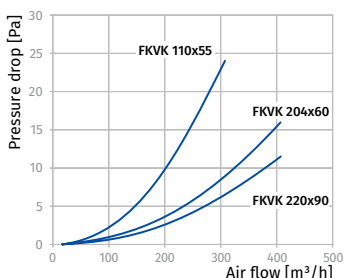
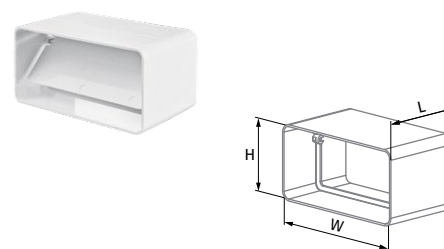

Flat duct connector FKSV

- Connection of same sized flat ducts **FK**
- Made of white plastic
- Designed for installation into air ducts and equipped with a lock ring for easy jointing

Model	H × W (Inner) [mm]	H × W (Outer) [mm]	L [mm]
BlauPlast FKSV 110x55	52 × 110	55 × 107	60
BlauPlast FKSV 204x60	57 × 204	60 × 200	60

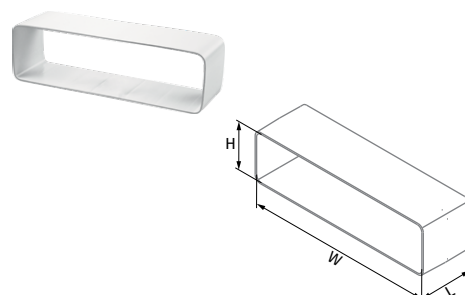

BLAUPLAST

FLAT PLASTIC DUCT SYSTEM

o Air duct connector with a plate FVP

- Connection of single size flat air ducts **FK**
- Decoration of mounting openings and connections to walls
- Made of white plastic
- Air ducts are fitted inside the connector
- Equipped with lock rings for easy adjustment
- Screw fixing to wall

Model	H [mm]	H1 [mm]	H2 [mm]	L [mm]	L1 [mm]	W [mm]	W1 [mm]	W2 [mm]
BlauPlast FVP 110x55	55	154	141	65	2	110	154	141
BlauPlast FVP 204x60	60	154	141	92	3	204	242	229

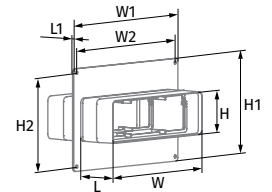

o Air duct connector with a plate and a back valve FVPK

- Connection of single size flat air ducts **FK**
- Decoration of mounting openings and connections to walls
- Made of white plastic
- Air ducts are fitted inside the connector
- Equipped with lock rings for easy adjustment
- Equipped with a back valve to prevent back drafting
- Screw fixing to wall

Model	H [mm]	H1 [mm]	H2 [mm]	L [mm]	L1 [mm]	W [mm]	W1 [mm]	W2 [mm]
BlauPlast FVPK 110x55	55	154	141	65	2	110	154	141
BlauPlast FVPK 204x60	60	154	141	92	3	204	242	229

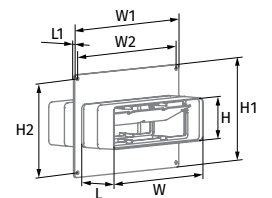

o Wall plate for flat ducts WP

- Connection of air ducts to ventilation shafts
- Decoration of mounting openings
- Made of white plastic
- Screw fixing to a wall

Model	H [mm]	H1 [mm]	H2 [mm]	L [mm]	W [mm]	W1 [mm]	W2 [mm]
BlauPlast WP 110x55	56	154	141	2	111	154	141
BlauPlast WP 204x60	61	154	141	3	205	242	229

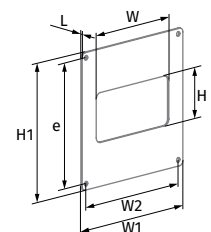

o Reducer for flat ducts FS

- Connection of flat different sized ducts
- Made of white plastic

Model	H × W [mm]	H1 × W1 [mm]	L [mm]
BlauPlast FS 110x54/204x60	55 × 110	60 × 204	30

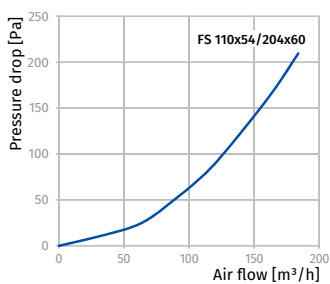
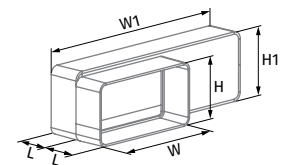

BLAUPLAST

FLAT PLASTIC DUCT SYSTEM

End grille DECOR

- Correct air flow distribution in premises
- Wall or ceiling mounting
- Made of white plastic
- Front part easily removed for cleaning
- Modification with an insect screen (s) is available

Model	H [mm]	H1 [mm]	L [mm]	W [mm]	W1 [mm]
DECOR 81x136	88	59	73	137	114
DECOR 86x230	93	64	76	232	208
DECOR 86x230/220x55	93	59	76	232	224

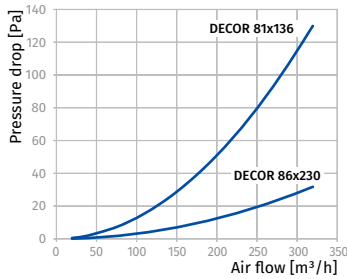
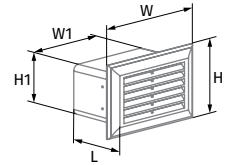

End grille with air pass regulation DECOR

- Correct air flow distribution in premises
- Wall or ceiling mounting
- Made of white plastic
- Equipped with a movable flap for air flow regulation
- Air pass is regulated with a tilt wand
- Front part easily removed for cleaning
- Modification with an insect screen (s) is available

Model	H [mm]	H1 [mm]	W [mm]	W1 [mm]	L [mm]
DECOR 81x136 R	88	59	137	114	73
DECOR 86x230 R	93	64	232	208	76

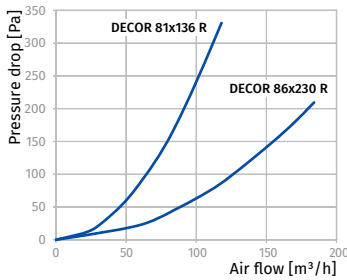
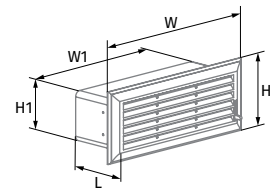

Reducer for flat and round ducts US/USV

- Flat to round duct connection
- Made of white plastic
- **BlauPlast US 100/110x55:** direct connection of the reducer to round and flat ducts
- **BlauPlast USV 100/110x55:** reducer has direct connection to flat air ducts and connection through the connector to round ducts

Model	Ø D [mm]	H × W [mm]	L [mm]	L1 [mm]
BlauPlast US 100/110x55	103	58 × 114	62	32
BlauPlast USV 100/110x55	100	58 × 114	62	32

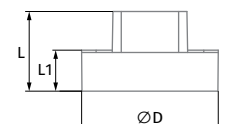
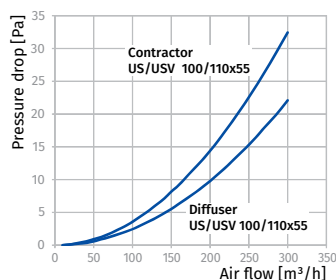
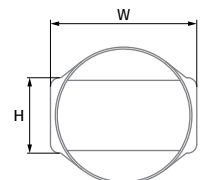

BLAUPLAST RRF/FKF

ROUND AND FLAT FOLDING PVC DUCT SYSTEM

The **BlauPlast foldable plastic air ducts** offer innovative and practical ventilation solutions. The foldable ducts enable efficient logistics and space saving during storage or exhibiting

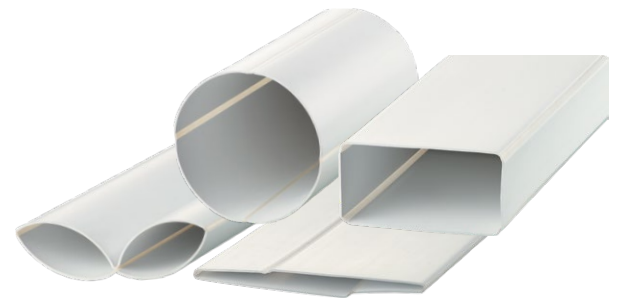

Features

- 40 % higher transportation efficiency – more units per dispatch. 60 % less warehouse storage space required.
- Improved showroom stock diversity – even at small shops. 20 % less time required for duct processing and fastening.
- Easy and efficient mounting, better fit of parts made of elastic polymer material.
- Compatible with standard connectors and fixtures of the BlauPlast air duct system.



Design and overall dimensions

BLAUPLAST RRF

- White PVC.
- Diameter 100 mm.
- Duct length ranges from 350 to 2500 mm.
- Joined by means of connectors of the appropriate diameter.

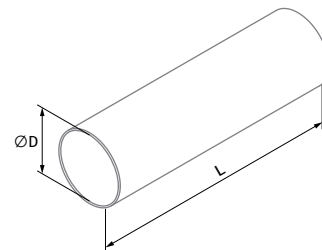

Dimensions [mm]	Ø D (Inner)	Ø D (Outer)	L
BlauPlast RRF 100/0.35	100	103	350
BlauPlast RRF 100/0.5	100	103	500
BlauPlast RRF 100/1	100	103	1000
BlauPlast RRF 100/1.5	100	103	1500
BlauPlast RRF 100/2	100	103	2000
BlauPlast RRF 100/2.5	100	103	2500

BLAUPLAST FKF

- White PVC.
- Cross-section of 55 × 110 mm.
- Duct length ranges from 350 to 2500 mm.
- Joined by means of appropriate section connectors.

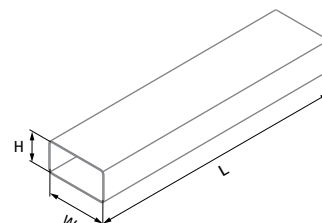

Dimensions [mm]	H (Inner)	W (Inner)	H (Outer)	W (Outer)	L
BlauPlast FKF 110x55/0.35	52	107	55	110	350
BlauPlast FKF 110x55/0.5	52	107	55	110	500
BlauPlast FKF 110x55/1	52	107	55	110	1000
BlauPlast FKF 110x55/1.5	52	107	55	110	1500
BlauPlast FKF 110x55/2	52	107	55	110	2000
BlauPlast FKF 110x55/2.5	52	107	55	110	2500

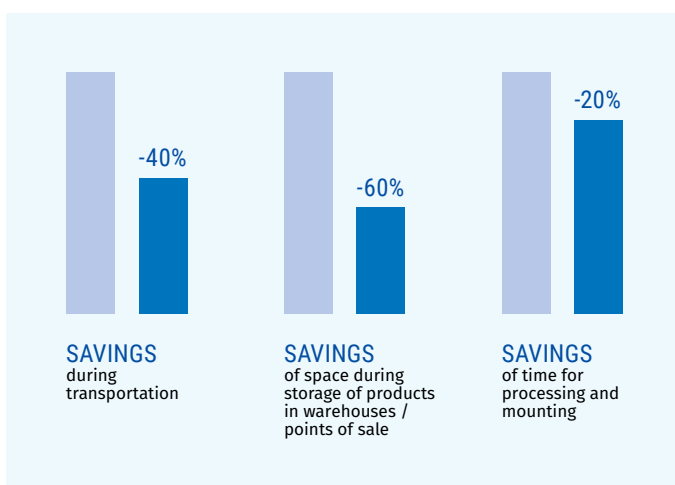

BLAUFLEX ISO N

FLEXIBLE AIR DUCTS

The **BlauFlex Iso N flexible insulated air ducts** are intended for domestic and industrial HVAC systems requiring heat insulation and air duct flexibility to prevent condensate build-up and minimise heat losses



o Flexible air duct BlauFlex Iso N

- Made from 40 µm metallised polyether film.
- The spiral armature is made of 0.8-1.5 mm thick high-carbon steel wire.
- The insulation is provided by a 25 mm layer of pollutant-free mineral wool.
- Maximum air flow speed is 30 m/s.
- Maximum working pressure is 3 000 Pa.
- Improved elasticity and thermal stability in the range from -30 to +120 °C (with short-term exposure to +120 °C).
- Does not release any noxious substances under normal operation.

Model	∅ d [mm]	L [m]	Base layer thickness [µm]	Mineral wool thickness [mm]
BlauFlex Iso N 82/7.6	82	7.6	40	25
BlauFlex Iso N 102/7.6	102	7.6	40	25
BlauFlex Iso N 127/7.6	127	7.6	40	25
BlauFlex Iso N 152/7.6	152	7.6	40	25
BlauFlex Iso N 162/7.6	162	7.6	40	25
BlauFlex Iso N 182/7.6	182	7.6	40	25
BlauFlex Iso N 203/7.6	203	7.6	40	25
BlauFlex Iso N 254/7.6	254	7.6	40	25
BlauFlex Iso N 315/7.6	315	7.6	40	25

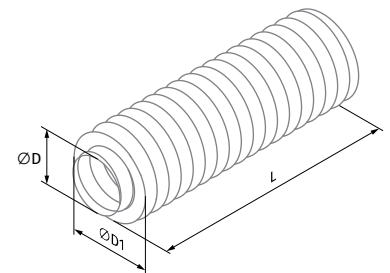

BLAUFLEX

FLEXIBLE AIR DUCTS

The BlauFlex flexible air ducts for residential and industrial ventilation, heating and air conditioning systems



Mounting

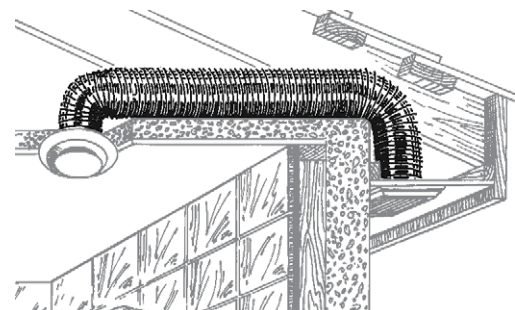
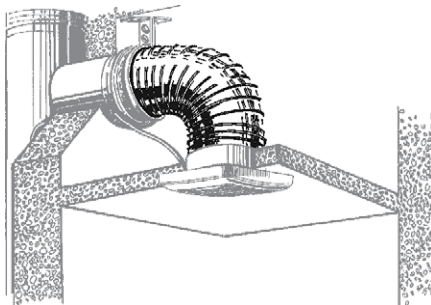

Flexible air duct BlauFlex AM / BlauFlex AN

- Made of 80 µm thick aluminium band for BlauFlex AN and 50 µm for BlauFlex AM
- Temperature range, °C: -30 ... +250

Model	Ø d [mm]	L [m]	Thickness [µm]
BlauFlex AN 80/3	80	3	80
BlauFlex AN 100/3	100	3	80
BlauFlex AN 110/3	110	3	80
BlauFlex AN 115/3	115	3	80
BlauFlex AN 120/3	120	3	80
BlauFlex AN 125/3	125	3	80
BlauFlex AN 130/3	130	3	80
BlauFlex AN 135/3	135	3	80
BlauFlex AN 140/3	140	3	80
BlauFlex AN 150/3	150	3	80
BlauFlex AN 160/3	160	3	80
BlauFlex AN 200/3	200	3	80
BlauFlex AN 250/3	250	3	80
BlauFlex AN 315/3	315	3	80
<hr/>			
BlauFlex AM 80/3	80	3	50
BlauFlex AM 100/3	100	3	50
BlauFlex AM 110/3	110	3	50
BlauFlex AM 115/3	115	3	50
BlauFlex AM 120/3	120	3	50
BlauFlex AM 125/3	125	3	50
BlauFlex AM 130/3	130	3	50
BlauFlex AM 135/3	135	3	50
BlauFlex AM 140/3	140	3	50
BlauFlex AM 150/3	150	3	50
BlauFlex AM 160/3	160	3	50
BlauFlex AM 200/3	200	3	50
BlauFlex AM 250/3	250	3	50
BlauFlex AM 315/3	315	3	50

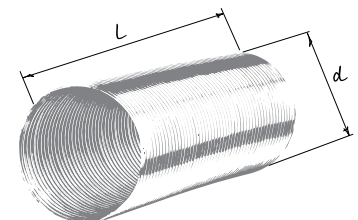

BLAUFLEX

FLEXIBLE AIR DUCTS

Flexible air duct BlauFlex AF

- Made of polyester laminated aluminium foil reinforced with spiral steel wire
- Temperature range, °C: -30 ... +250 (for BlauFlex AF M0), -30 ... +150 (BlauFlex AF M1)

Model	Ø d [mm]	L [m]
BlauFlex AF M0/102/1	102	1
BlauFlex AF M0/102/3	102	3
BlauFlex AF M0/102/6	102	6
BlauFlex AF M0/102/10	102	10
BlauFlex AF M0/127/1	127	1
BlauFlex AF M0/127/3	127	3
BlauFlex AF M0/127/6	127	6
BlauFlex AF M0/127/10	127	10
BlauFlex AF M0/152/1	152	1
BlauFlex AF M0/152/3	152	3
BlauFlex AF M0/152/6	152	6
BlauFlex AF M0/152/10	152	10
BlauFlex AF M1/102/1	102	1
BlauFlex AF M1/102/3	102	3
BlauFlex AF M1/102/6	102	6
BlauFlex AF M1/102/10	102	10
BlauFlex AF M1/127/1	127	1
BlauFlex AF M1/127/3	127	3
BlauFlex AF M1/127/6	127	6
BlauFlex AF M1/127/10	127	10
BlauFlex AF M1/152/1	152	1
BlauFlex AF M1/152/3	152	3
BlauFlex AF M1/152/6	152	6
BlauFlex AF M1/152/10	152	10

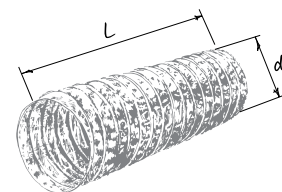

Flexible air duct BlauFlex PVC

- Made of 65 µm thick white PVC film reinforced with steel wire frame
- Temperature range, °C: -18 ... +70

Model	Ø d [mm]	L [m]
BlauFlex PVC/82/1	82	1
BlauFlex PVC/82/3	82	3
BlauFlex PVC/82/6	82	6
BlauFlex PVC/82/10	82	10
BlauFlex PVC/102/1	102	1
BlauFlex PVC/102/3	102	3
BlauFlex PVC/102/6	102	6
BlauFlex PVC/102/10	102	10
BlauFlex PVC/127/1	127	1
BlauFlex PVC/127/3	127	3
BlauFlex PVC/127/6	127	6
BlauFlex PVC/127/10	127	10
BlauFlex PVC/152/1	152	1
BlauFlex PVC/152/3	152	3
BlauFlex PVC/152/6	152	6
BlauFlex PVC/152/10	152	10

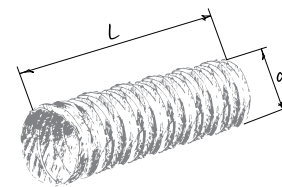

FITTINGS

FITTINGS FOR ROUND AIR DUCTS

The mounting fittings are used for fixation and connection of round air ducts



Clamp for round flexible ducts K

- Made of stainless steel (K) or galvanized steel (K ... Zn)
- Mounting of flexible air ducts

Model	Ø D [mm]	H (Band width) [mm]
K 100 (Zn)	90-110	9
K 125 (Zn)	110-130	9
K 150 (Zn)	140-160	9
K 160 (Zn)	150-170	9
K 200 (Zn)	190-210	9

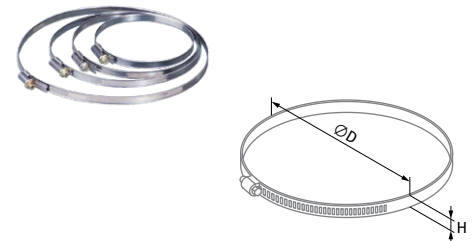

Clamp for round ducts KZ

- Made of galvanized steel with microporous rubber for vibration damping
- Mounting of round air ducts
- Wall or ceiling mounting (KZH)

Model	Ø D [mm]	H (Height) [mm]
KZ 80	80	152
KZ 100	100	172
KZ 125	125	198
KZ 150	150	224
KZ 160	160	232
KZ 200	200	274
KZ 250	250	326
KZ 315	315	380
KZH 80	80	94
KZH 100	100	204
KZH 125	125	229
KZH 150	150	254
KZH 160	160	264
KZH 200	200	304
KZH 250	250	354
KZH 315	315	419

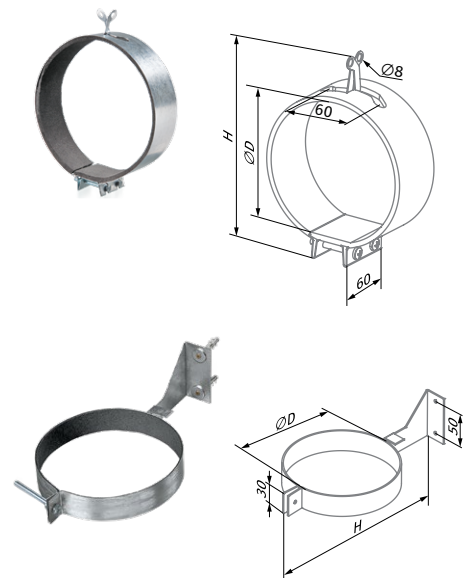

Flange for round ducts AP

- Made of white plastic
- Connection of round flexible air ducts
- Wall or ceiling mounting with screws
- Equipped with a lock ring for fixation of flexible air ducts

Model	Ø D [mm]	Ø D1 [mm]	Ø D2 [mm]	L [mm]
AP 80	80	115	120	62
AP 100	100	132	139	62
AP 125	125	157	165	62
AP 150	150	179	188	62
AP 200	200	232	240	62

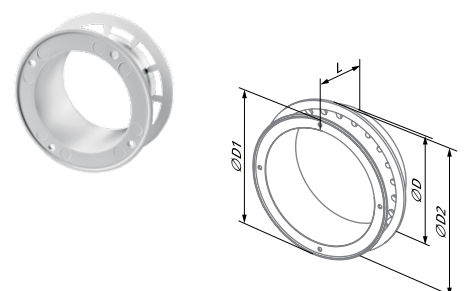

FITTINGS

FITTINGS FOR ROUND AIR DUCTS

o Flange for round ducts FRM, FRZ

- Made of white polymer coated steel (**FRM**) or galvanized steel (**FRZ**)
- The **FRZ ... S** models are equipped with a U-shape sealant to avoid air leakage
- Connection of round flexible air ducts
- Wall or ceiling mounting with screws

Model	Ø D [mm]	Ø D1 [mm]	L [mm]
FRM 80	80	116	62
FRM 100	100	136	62
FRM 125	125	162	62
FRM 150	150	186	62
FRM 160	160	196	62
FRM 200	200	236	62
FRM 250	250	286	62
FRM 315	315	351	62
FRZ 80	80	116	62
FRZ 100	100	136	62
FRZ 125	125	162	62
FRZ 150	150	186	62
FRZ 160	160	196	62
FRZ 200	200	236	62
FRZ 250	250	286	62
FRZ 315	315	351	62
FRZ 100 S	100	136	62
FRZ 125 S	125	162	62
FRZ 150 S	150	186	62
FRZ 200 S	200	236	62

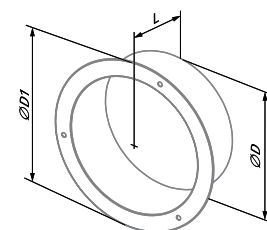

o Round duct reducer RSM, RSZ

- Made of white polymer coated steel (**RSM**) or galvanized steel (**RSZ**)
- For connection of round air ducts

Model	Ø D [mm]	Ø D1 [mm]	L [mm]
RSM 80/100	80	100	115
RSM 100/125	100	125	125
RSM 100/150	100	150	125
RSM 125/150	125	150	125
RSM 125/160	125	160	144
RSM 150/160	150	160	172
RSM 160/200	160	200	154
RSM 150/200	150	200	172
RSM 200/250	200	250	172
RSM 250/315	250	315	195
RSZ 80/100	80	100	115
RSZ 100/125	100	125	125
RSZ 100/150	100	150	125
RSZ 125/150	125	150	125
RSZ 125/160	125	160	144
RSZ 150/160	150	160	172
RSZ 160/200	160	200	154
RSZ 150/200	150	200	172
RSZ 200/250	200	250	172
RSZ 250/315	250	315	195

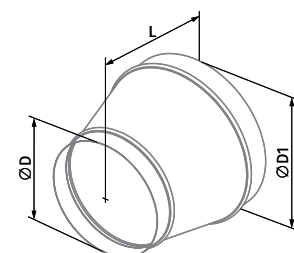

FITTINGS

FITTINGS FOR ROUND AIR DUCTS

o Cross joint for round duct KSM, KSZ

- Made of white polymer coated steel (**KSM**) or galvanized steel (**KSZ**)
- Connection of round air ducts

Model	Ø D1 [mm]	Ø D2 [mm]	L [mm]
KSM 80	80	80	170
KSM 100	100	100	190
KSM 125	125	125	215
KSM 150	150	150	240
KSM 160	160	160	250
KSM 200	200	200	300
KSM 250	250	250	350
KSM 315	315	315	415
KSZ 80	80	80	170
KSZ 100	100	100	190
KSZ 125	125	125	215
KSZ 150	150	150	240
KSZ 160	160	160	250
KSZ 200	200	200	300
KSZ 250	250	250	350
KSZ 315	315	315	415

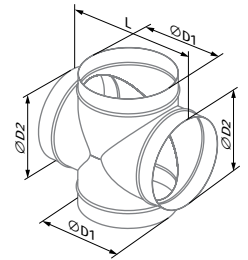

o T-connector for round air ducts TSM-90°, TSZ-90°

- Made of white polymer coated steel (**TSM**) or galvanized steel (**TSZ**)
- Connection of round air ducts

Model	Ø D1 [mm]	Ø D2 [mm]	L [mm]
TSM-90° 80	80	80	170
TSM-90° 100	100	100	190
TSM-90° 125	125	125	215
TSM-90° 150	150	150	240
TSM-90° 160	160	160	250
TSM-90° 200	200	200	300
TSM-90° 250	250	250	350
TSM-90° 315	315	315	415
TSZ-90° 80	80	80	170
TSZ-90° 100	100	100	190
TSZ-90° 125	125	125	215
TSZ-90° 150	150	150	240
TSZ-90° 160	160	160	250
TSZ-90° 200	200	200	300
TSZ-90° 250	250	250	350
TSZ-90° 315	315	315	415

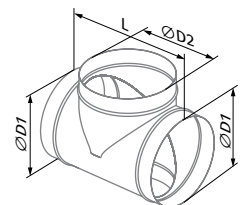

o Backdraft damper for round ducts VRV

- Galvanized steel body and aluminium blades
- For prevention of back drafting in round air ducts
- Damper blades are opened by pressure and closed with a spring
- Connection to round air ducts by clamps

Model	Ø D [mm]	L [mm]
VRV 100	99	80
VRV 125	124	100
VRV 150	149	115
VRV 160	159	120
VRV 200	199	145
VRV 250	249	165
VRV 315	314	190

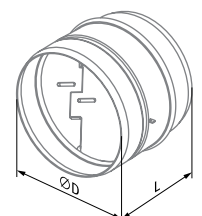

FITTINGS

FITTINGS FOR ROUND AIR DUCTS

Round duct connector SVM, SVZ

- Made of white polymer coated steel (SVM) or galvanized steel (SVZ)
- Connection of round air ducts

Model	Ø D [mm]	L [mm]
SVM 80	80	62
SVM 100	100	62
SVM 125	125	62
SVM 150	150	62
SVM 160	160	62
SVM 200	200	62
SVM 250	250	62
SVM 315	315	62
SVZ 80	80	62
SVZ 100	100	62
SVZ 125	125	62
SVZ 150	150	62
SVZ 160	160	62
SVZ 200	200	62
SVZ 250	250	62
SVZ 315	315	62

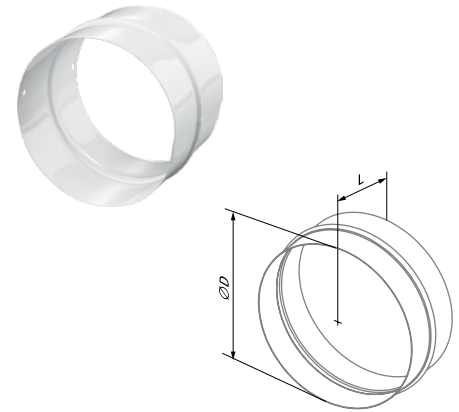

Spigot with a plate for round ducts FQM, FQZ

- Made of white polymer coated steel (FQM) or galvanized steel (FQZ)
- Mounting with round air ducts
- Wall or ceiling mounting with screws

Model	Ø D [mm]	a [mm]	b [mm]	L [mm]
FQM 80	80	130 × 130	114 × 114	50
FQM 100	100	150 × 150	134 × 134	50
FQM 125	125	170 × 170	156 × 156	50
FQM 150	150	204 × 204	188 × 188	50
FQM 160	160	210 × 210	194 × 194	50
FQM 200	200	250 × 250	234 × 234	50
FQM 250	250	300 × 300	284 × 284	50
FQM 315	315	360 × 360	344 × 344	50
FQZ 80	80	130 × 130	114 × 114	50
FQZ 100	100	150 × 150	134 × 134	50
FQZ 125	125	170 × 170	156 × 156	50
FQZ 150	150	204 × 204	188 × 188	50
FQZ 160	160	210 × 210	194 × 194	50
FQZ 200	200	250 × 250	234 × 234	50
FQZ 250	250	300 × 300	284 × 284	50
FQZ 315	315	360 × 360	344 × 344	50

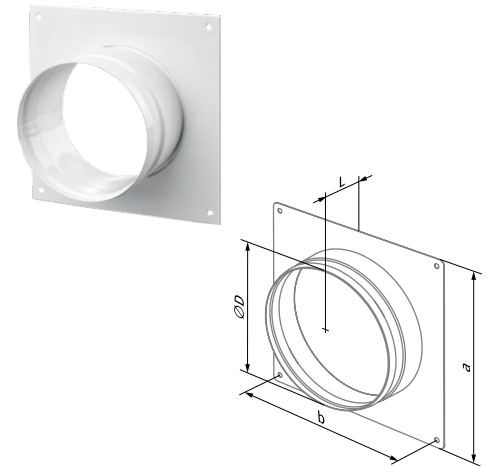



Blauberg Ventilatoren GmbH
Aidenbachstr. 52
D-81379 Munich

info@blaubergventilatoren.de
www.blaubergventilatoren.de

Technical changes reserved.
Illustrations and texts are non-binding.

02/2021