





INDUSTRIAL VENTILATION

CONTENTS

Inline fans

	Turbo	8
	Turbo EC	12
	Ducto	16
	Primo	18
	Primo EC	20
	Centro (V2)	22
	Centro EC	30
	Centro-M	36
	Centro-M EC	44
	Centro-MZ	50

Inline fans

	Box	54
	Box-R	56

Inline reversible fans

	Altero 150	60
--	------------	----

Exhaust fans

	Ceileo	62
	Ceileo DC	64
	Ceileo Compact	66
	Ceileo Compact DC	68
	Box-D	70
	Extero	72

Exhaust fans



Extero EC 74

Sound-insulated inline fans

Iso-Mix 78

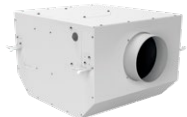

Iso-Mix EC 84



Iso Box-R (V2) 88



Iso Box-F (V2) 92



Iso Box-F ES (V2) 102



Iso-B 108



Iso-B EC 112



Iso-RB 116



Iso-RB EC 122

Sound-insulated fans

Iso-RF EC 128



Iso-V 132



Iso-V EC 138



Iso-ZS 142



Iso-K 146

Centrifugal fans

Helix 152



S-Vent 156

Axial fans

Tubo-M / Tubo-MZ 164



Axis-F 166



Axis-Q 174

Axial fans



Axis-QR 182



Axis-QA 190



Axis-QRA 192

Roof fans



Tower-V 194



Tower-V EC 202



Tower-H 208



Tower-H EC 216



Tower-AM 222



Tower-A 224



Tower-AL 226

Inline fans for rectangular ducts



Box 228



Box EC 234



Box-I 240



Box-I EC 246



Box-F 252



Box-FI 258

Chimney fans



Kamin / Kamin-ER 264

Exhaust fans for mono-pipe ventilation



Valeo 268



Valeo-BP 274

Exhaust fans for mono-pipe ventilation



Valeo-BF 278



Valeo-E 282

Accessories for Tower series roof fans



MRDL / MRIDL 286



KDL 287



VDL 288



FDL 289

Units for air cooling and heating



ALBE 290

Heaters



EKH 294



WKH 298

Heaters



EKH 304



WKH 308

Heat exchangers

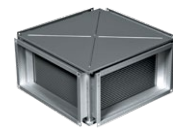

KWT 318

Coolers



KWK 320



KFK 328

Droplet separators



TA 335

Silencers



SD 336



SDF 338





SD 340

Air dampers

	VK	342
	VKA	343
	VK	344
	SL	345
	VRV	346
	VRVS	347
	VRVS	348

Gravity air dampers

	VG	350
	VG	351







Flexible anti-vibration connectors

	EVA	352
---	-----	-----



Flexible anti-vibration connectors

	EVAF	353
	EVA	354

Filter boxes

	Clean Box	356
	KFBK	360
	KFBV	361
	KFBT	362
	KFBT	364
	KFBK	366

Clamps

	KZ	368
	KZH	369

Step-down transformers

	AT-25 220/12	370
	ATK-25 220/12	371
	AT-40 230/12	372

Speed controllers

	CDTE E/0-10	381
	CDPI-2 E5 / CDPI-3 E5	382
	CDPE-2 E5 / CDPE-3 E5	383
	CDT1 E	384
	CDT E / CDTE E	385

Speed controllers

	SGR-3/1	374
	SGS E1	375
	CDP-2/10	376
	CDP-2/5 (3/5)	377
	CDT E1.8	378
	CDTE E1.8	379
	CDT E/0-10	380

Temperature regulators

	TS E10	386
	MLC E2 / MLCD E2	387

Sensors and timers

	CD-1 / CD-2	388
	HR-S	389
	DRWQ40200	390

Sensors and timers

DPWC11200 391



DPWQ30600 392

TE / TI 1.5,
HSE / HSI 1.5, LSE / LSI 1.5,
IRSE / IRSI 1.5 393**Electric actuators**

BELIMO CM230/CM24 394



BELIMO LM230A/LM24A 395



BELIMO TF230/TF24 396



BELIMO LF230/LF24 397

Swirl diffusers

DWP2 398

Turbo

Inline mixed-flow fans

Use

- Supply and extract ventilation systems installed in various premises.
- Mounting in kitchens, bathrooms and other humid premises.
- Ventilation air ducts requiring high pressure, powerful air flow and low noise level.
- Compatible with Ø 100 up to 315 mm round air ducts.



Air flow:
up to 1750 m³/h
486 l/s



Power:
from 23 W



Noise level:
from 27 dBA



Design

- The casing is made of low-flammable polypropylene.
- Ventilation unit with terminal box. Can be turned to any position.
- Special design of the casing permits easy dismantling of the impeller and motor block for fan servicing without dismantling the air duct.

Motor

- Two-speed single-phase motor on ball bearings.
- Equipped with thermal overheating protection.

Speed control

- The control (minimum speed, maximum speed and shutdown) is executed with the integrated three-position switch (**US** modification) or with the external switch for multi-speed fans (specially ordered accessory).
- Smooth speed control is possible with a built-in speed controller (**FR1** modification) or an external thyristor speed controller (available upon separate order).

Mounting











- Due to the compact design the fan is the ideal solution for mounting in limited spaces, including space behind a false ceiling.
- The fan can be installed in any section of the ventilation system from intake to the end of the ductworks.
- Wall or ceiling mounting with a mounting plate.
- TD:** mounting kit for installation of one diameter fans in parallel (for boosting capacity)



- TL:** mounting kit for installation of one diameter fans in series (for boosting pressure).



Accessories

Silencers	Filter boxes	Electric heaters	Water heaters	Backdraft air dampers	Air dampers	Clamps	Temperature controllers	Speed controllers	Timers/Sensors
									
SD	KFBK / KFBT	EKH	WKH	VRV	VK / VKA	K	MLCD E2	CDT / CDP	TE(TI) / HSE(HSI) / LSE(LSI) / IRSE(IRSI)

Modifications

- o **T:** turn-off delay timer adjustable from 2 to 30 minutes.
- o **US:** three-position speed switch.



- o **FR1:** smooth speed controller adjustable from 0 to 100 % and power cable with mains plug.



- o **G1:** speed controller, temperature controller with external temperature sensor (cable length 4 m), power cable with mains plug.



- o **GT1:** speed controller, temperature controller with external temperature sensor (cable length 4 m), 5 min timer switch and power cable with mains plug.
- o **G11:** speed controller, temperature controller with integrated temperature sensor and power cable with mains plug.
- o **GT11:** speed controller, temperature controller with integrated temperature sensor, 5 min timer switch and power cable with mains plug.
- o The **G1** and **G11** modifications enable automatic speed control depending on indoor temperature. The optimal ventilation solution for premises requiring permanent temperature control as greenhouses, orangeries, etc.
- o **W1:** power cable with mains plug.

Designation key		
Series	Duct diameter [mm]	Modifications
Turbo	100; 125; 150; 160; 200; 250; 315	T: turn-off delay timer adjustable from 2 to 30 minutes US: three-position speed switch FR1: smooth speed controller adjustable from 0 to 100 % and power cable with mains plug G1: speed controller, temperature controller with external temperature sensor, power cable with mains plug GT1: speed controller, temperature controller with external temperature sensor, 5 min timer switch and power cable with mains plug G11: speed controller, temperature controller with integrated temperature sensor and power cable mains plug GT11: speed controller, temperature controller with integrated temperature sensor, 5 min timer switch and power cable with mains plug W1: power cable with mains plug

Overall dimensions [mm]

Model	Ø D	Ø D1	B	H	L	Weight [kg]
Turbo 100	97	164	196	241	303	1.68
Turbo 125	123	164	196	241	258	1.79
Turbo 150	148	187	220	251	289	3.18
Turbo 160	158	187	220	251	289	3.23
Turbo 200	199	209	239	261	295.5	3.8
Turbo 250	247	257	287	323	383	7.83
Turbo 315	310	323	362	408	445	11.7

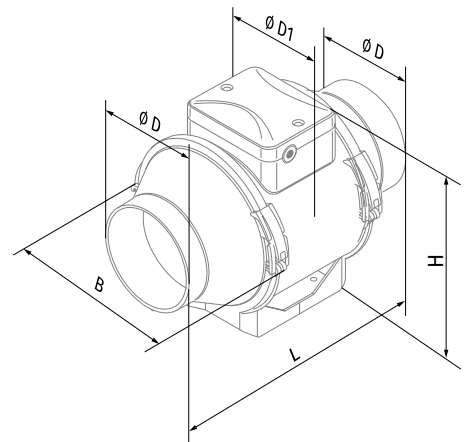

Technical data

Parameters	Turbo 100		Turbo 125		Turbo 150 / Turbo 160	
Speed	min	max	min	max	min	max
Voltage [V]	1 ~ 230		1 ~ 230		1 ~ 230	
Frequency [Hz]	50/60		50/60		50/60	
Power [W]	23		25		42	
Current [A]	0.10		0.11		0.19	
Maximum air flow [m ³ /h (l/s)]	170 (47)		220 (61)		430 (119)	
RPM [min ⁻¹]	1980		1535		2265	
Sound pressure level at 3 m [dBA]	27		29		32	
Max. transported air temperature [°C]	+60		+60		+60	
SEC class	C		B		B	
IP rating	IPX4		IPX4		IPX4	
Motor IP rating	IPX4		IPX4		IPX4	
ErP	-		-		2018	

TURBO 100

Sound power level, A-weighted	Total	Octave frequency bands [Hz]								LpA 3 m	LpA 1 m
		63	125	250	500	1000	2000	4000	8000		
Min speed											
L _{WA} to inlet [dBA]	54	19	35	50	49	44	37	25	17	33	43
L _{WA} to outlet [dBA]	53	17	34	50	49	48	36	24	17	32	42
L _{WA} to environment [dBA]	47	14	29	43	43	39	33	22	15	27	37
Max speed											
L _{WA} to inlet [dBA]	59	24	34	53	54	53	48	37	26	38	48
L _{WA} to outlet [dBA]	57	23	33	52	52	52	47	37	26	37	47
L _{WA} to environment [dBA]	52	18	29	46	48	47	43	33	23	32	42

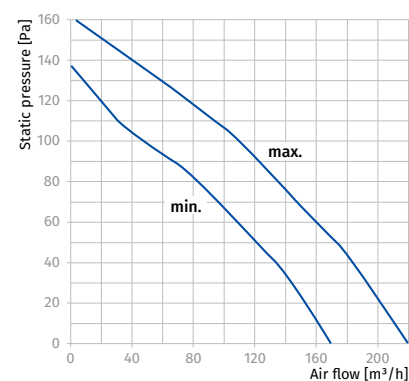

TURBO 125

Sound power level, A-weighted	Total	Octave frequency bands [Hz]								LpA 3 m	LpA 1 m
		63	125	250	500	1000	2000	4000	8000		
Min speed											
L _{WA} to inlet [dBA]	54	26	38	52	50	44	38	27	17	34	44
L _{WA} to outlet [dBA]	54	25	37	51	49	43	38	28	18	33	43
L _{WA} to environment [dBA]	49	21	32	46	45	40	35	25	16	29	39
Max speed											
L _{WA} to inlet [dBA]	60	20	31	57	51	51	50	39	27	39	49
L _{WA} to outlet [dBA]	59	20	31	56	51	51	49	39	26	38	48
L _{WA} to environment [dBA]	54	16	27	51	46	47	45	36	24	34	44

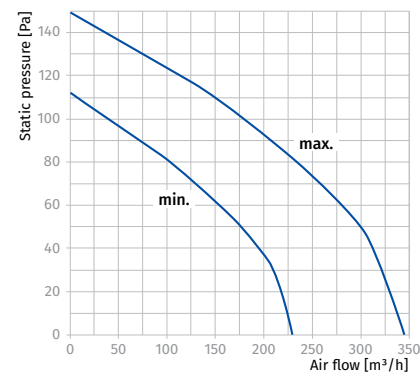

TURBO 150 / 160

Sound power level, A-weighted	Total	Octave frequency bands [Hz]								LpA 3 m	LpA 1 m
		63	125	250	500	1000	2000	4000	8000		
Min speed											
L _{WA} to inlet [dBA]	59	31	45	54	52	54	48	35	29	38	48
L _{WA} to outlet [dBA]	63	37	49	56	56	60	48	39	30	42	52
L _{WA} to environment [dBA]	52	21	30	48	48	45	42	34	23	32	42
Max speed											
L _{WA} to inlet [dBA]	69	38	51	57	62	60	66	49	44	48	58
L _{WA} to outlet [dBA]	72	42	55	66	67	68	65	53	45	52	62
L _{WA} to environment [dBA]	65	23	37	56	59	57	61	47	35	44	54

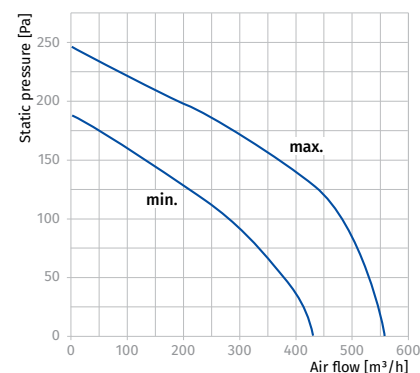

Parameters	Turbo 200		Turbo 250		Turbo 315	
Speed	min	max	min	max	min	max
Voltage [V]	1 ~ 230	1 ~ 230	1 ~ 230	1 ~ 230	1 ~ 230	1 ~ 230
Frequency [Hz]	50/60	50/60	50/60	50/60	50/60	50/60
Power [W]	76	108	125	177	227	315
Current [A]	0.34	0.48	0.54	0.79	0.99	1.42
Maximum air flow [m³/h (l/s)]	805 (224)	1080 (300)	1070 (297)	1360 (378)	1420 (394)	1750 (486)
RPM [min⁻¹]	1915	2380	1955	2440	2115	2505
Sound pressure level at 3 m [dBA]	39	45	44	51	41	52
Max. transported air temperature [°C]	+60		+60		+60	
SEC class	B		-		-	
IP rating	IPX4		IPX4		IPX4	
Motor IP rating	IPX4		IPX4		IPX4	
ErP	2018		2018		2018	

TURBO 200

Sound power level, A-weighted	Total	Octave frequency bands [Hz]								LpA 3 m	LpA 1 m
		63	125	250	500	1000	2000	4000	8000		
Min speed											
LWA to inlet [dBA]	66	38	50	58	59	60	59	55	45	45	55
LWA to outlet [dBA]	64	40	50	54	58	59	57	51	44	43	53
LWA to environment [dBA]	60	27	42	49	54	55	54	46	34	39	49
Max speed											
LWA to inlet [dBA]	71	41	50	63	64	65	64	62	52	50	60
LWA to outlet [dBA]	70	43	52	61	66	64	63	58	51	50	60
LWA to environment [dBA]	65	34	43	54	60	60	60	53	41	45	55

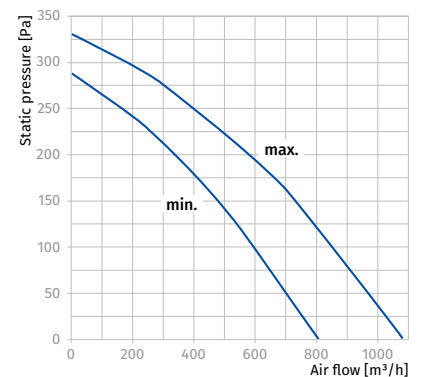

TURBO 250

Sound power level, A-weighted	Total	Octave frequency bands [Hz]								LpA 3 m	LpA 1 m
		63	125	250	500	1000	2000	4000	8000		
Min speed											
LWA to inlet [dBA]	72	48	57	63	66	69	64	54	45	52	62
LWA to outlet [dBA]	75	48	56	64	70	71	66	56	45	54	64
LWA to environment [dBA]	65	32	51	57	61	59	56	45	32	44	54
Max speed											
LWA to inlet [dBA]	78	52	62	66	71	75	72	62	52	58	68
LWA to outlet [dBA]	81	52	60	66	76	77	74	63	52	60	70
LWA to environment [dBA]	72	35	50	63	69	66	63	53	40	51	61

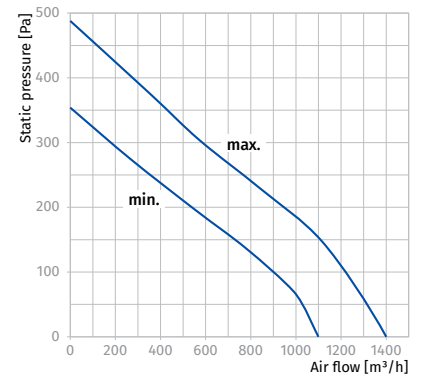

TURBO 315

Sound power level, A-weighted	Total	Octave frequency bands [Hz]								LpA 3 m	LpA 1 m
		63	125	250	500	1000	2000	4000	8000		
Min speed											
LWA to inlet [dBA]	72	43	54	62	67	66	67	58	47	52	62
LWA to outlet [dBA]	70	45	57	59	64	66	63	56	46	50	60
LWA to environment [dBA]	62	28	51	53	57	57	54	46	36	41	51
Max speed											
LWA to inlet [dBA]	80	50	59	68	73	77	74	70	59	60	70
LWA to outlet [dBA]	78	51	60	66	70	75	71	66	57	58	68
LWA to environment [dBA]	72	37	51	66	66	67	65	58	48	52	62

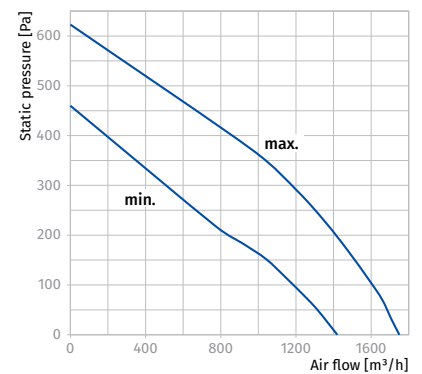

INLINE FANS

Turbo EC

Inline mixed-flow fans with EC motor

Use

- Designed for supply and exhaust ventilation systems requiring high energy efficiency, excellent response, high pressure and air flow rate while keeping noise under control – such as high-humidity commercial and industrial spaces (e.g. bathrooms and kitchens) as well as flats, villas, shops and cafes.
- Compatible with air ducts from 100 to 315 mm in diameter.



Air flow:
up to 1970 m³/h
547 l/s



Power:
from 30 W



Noise level:
from 46 dBA



Design

- Turbo EC fans combine the versatility and outstanding performance of both axial and centrifugal fans producing a powerful air flow and high pressure while retaining the signature energy-efficiency and response of EC motors.
- The casing of Turbo EC fan is made of low-combustible polypropylene. The removable central unit with a motor, impeller and terminal box is attached to the fittings by means of special mounting brackets with integral latches. This helps to make the fan maintenance extremely simple and convenient. Fan service no longer requires major disassembly and dismantling of the fan: all you have to do is remove the main unit from the casing and carry out the maintenance as required.
- The inlet fitting has a profiled header which ensures smooth air flow into the fan. Conically shaped impeller with specially profiled blades cause circular velocity rise, that results in air flow boost and pressure increase comparing to conventional design.
- The fan outlet combination of a diffuser, specially designed impeller and rectifier allow for the optimum air distribution: high air capacity and pressure without excessive noise.

Motor

- High-efficient direct current EC motor.
- EC technology meets the up-to-date requirements to energy-saving and controllable ventilation and provides up to 35 % energy saving as compared to asynchronous motors.
- EC motor ensures totally controllable speed range for the fan and has integrated overheating protection with automatic restart.
- EC motor has no friction and wearing parts as capacitor and brushes. Instead a maintenance-free EC controller electronic circuit board is used.
- The impeller is dynamically balanced.
- The fan is compatible with 50 Hz and 60 Hz power mains and the maximum speed does not depend on power mains frequency.

Speed control

- The fan speed is controlled with a 0–10 V control signal from the following sources:
 - integrated or external speed controller
 - controller with sensors
 - central BMS system.
- The control signal value changes depending on air temperature, pressure, smoke concentration and other parameters.
- During signal value change the fan with EC motor correspondingly changes the rotations speed and delivers required air volume to the ventilation system.
- The computer central building management systems (BMS) enable integration of several EC motors in network and precise individual operation control for each fan.

Mounting

- The fans are intended for installation in matching diameter air ducts at any point of the ventilation system without limitation to mounting angle.
- The fan casing has a flat mounting plate for a secure wall mounting.
- Electrical connection and installation must be performed in accordance with the instruction manual and the electrical connections diagram applied to the terminal box.
- A single system may have several fans installed in parallel to boost the output capacity or in series to boost the working pressure.

Designation key

Series	Motor type	Duct diameter [mm]
Turbo	EC: electronically commutated motor	100; 125; 150; 160; 200; 250; 315

Accessories

Silencers	Filter boxes	Electric heaters	Water heaters	Backdraft air dampers	Air dampers	Clamps	Speed controllers
							
SD	KFBK / KFBT	EKH	WKH	VRV	VK / VKA	K	CDT E/0-10

Overall dimensions [mm]

Type	Ø D	Ø D1	B	H	L	Weight [kg]
Turbo EC 100	98	164	192	241	302.5	1.75
Turbo EC 125	123	164	193	241	258.5	2.15
Turbo EC 150	148	187	216.5	253.5	289	2.3
Turbo EC 160	158	187	216.5	253.5	289	3.25
Turbo EC 200	198	209	239	277.5	295.5	3.95
Turbo EC 250	247	257	288	339	383	7.8
Turbo EC 315	308.5	323	360	423	443	11.95

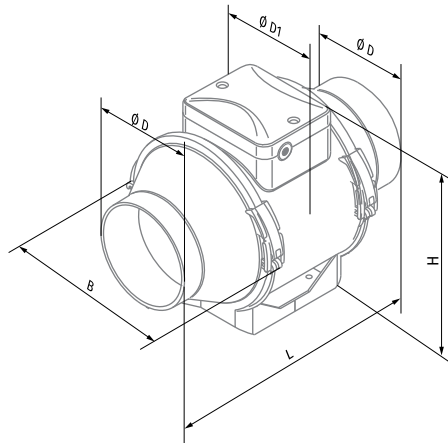

Technical data

Parameters	Turbo EC 100	Turbo EC 125	Turbo EC 150 (160)	Turbo EC 200	Turbo EC 250	Turbo EC 315
Voltage [V / 50/60 Hz]	1~ 230	1~ 230	1~ 230	1~ 230	1~ 230	1~ 230
Power [W]	30	40	55	123	169	284
Current [A]	0.29	0.37	0.48	1.02	1.38	1.25
Max. airflow [m³/h (l/s)]	300 (83)	450 (125)	600 (167)	1040 (289)	1285 (357)	1970 (547)
RPM [min⁻¹]	3680	3750	3390	3390	2870	2826
Sound pressure level at 3m [dBA]	47	49	46	49	53	55
Transported air temperature [°C]	-25...+55	-25...+55	-25...+55	-25...+55	-25...+55	-25...+55
Protection rating	IPX4	IPX4	IPX4	IPX4	IPX4	IPX4
SEC Class	B	B	B	-	-	-
Erp compliance	2018	2018	2018	2018	2018	2018

TURBO EC 100

Sound power level, A-weighted	Total	Octave frequency bands [Hz]								LpA 3 m	LpA 1 m
		63	125	250	500	1000	2000	4000	8000		
LWA to inlet [dBA]	74	42	55	62	70	69	66	58	52	54	63
LWA to outlet [dBA]	69	33	42	59	66	63	62	57	50	49	59
LWA to environment [dBA]	67	27	45	55	65	62	60	49	38	47	57

TURBO EC 125

Sound power level, A-weighted	Total	Octave frequency bands [Hz]								LpA 3 m	LpA 1 m
		63	125	250	500	1000	2000	4000	8000		
LWA to inlet [dBA]	76	36	46	60	75	66	65	61	54	56	66
LWA to outlet [dBA]	74	34	48	61	70	69	64	60	53	53	63
LWA to environment [dBA]	70	33	48	56	68	63	60	52	42	49	59

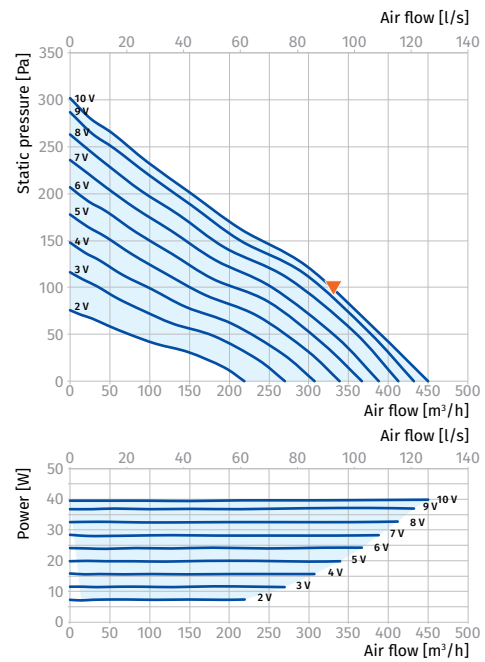
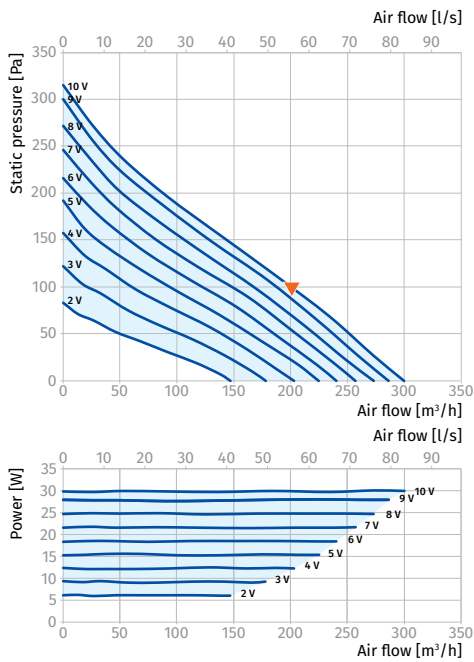

INLINE FANS

TURBO EC 150 (160)

Sound power level, A-weighted ▼	Total	Octave frequency bands [Hz]								LpA 3 m	LpA 1 m
		63	125	250	500	1000	2000	4000	8000		
LWA to inlet [dBA]	70	37	43	58	65	63	65	59	52	50	60
LWA to outlet [dBA]	68	41	45	52	60	63	63	59	52	47	57
LWA to environment [dBA]	67	32	44	59	63	59	58	51	43	46	56

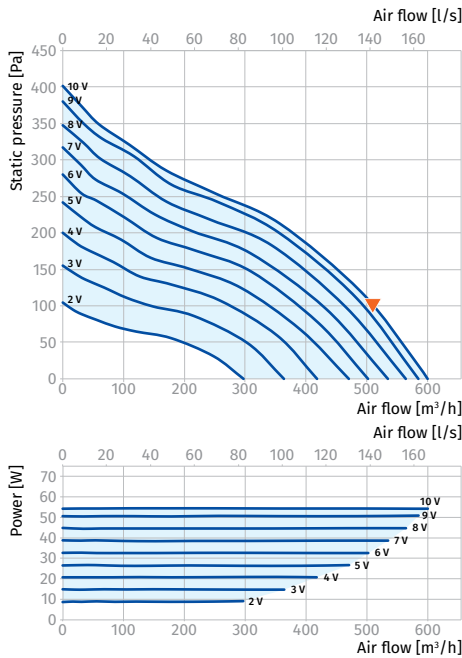

TURBO EC 200

Sound power level, A-weighted ▼	Total	Octave frequency bands [Hz]								LpA 3 m	LpA 1 m
		63	125	250	500	1000	2000	4000	8000		
LWA to inlet [dBA]	76	36	45	57	70	69	72	69	59	56	65
LWA to outlet [dBA]	76	48	49	56	69	71	71	70	60	56	65
LWA to environment [dBA]	69	35	42	54	64	65	65	58	43	49	59

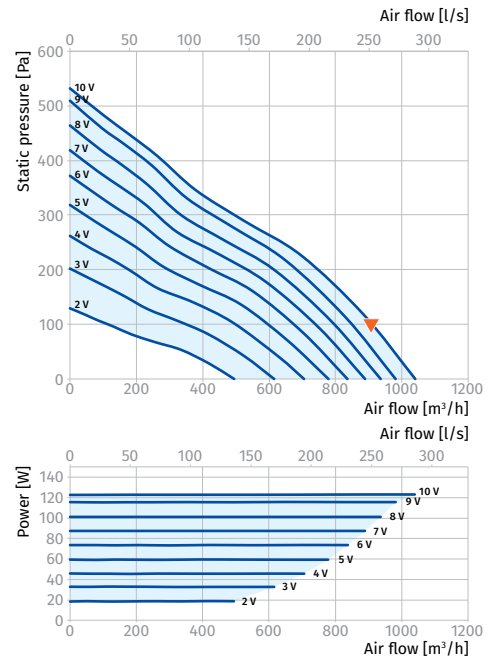

TURBO EC 250

Sound power level, A-weighted ▼	Total	Octave frequency bands [Hz]								LpA 3 m	LpA 1 m
		63	125	250	500	1000	2000	4000	8000		
LWA to inlet [dBA]	81	43	51	64	77	77	77	69	62	61	71
LWA to outlet [dBA]	81	49	54	67	75	78	77	72	62	61	71
LWA to environment [dBA]	73	53	49	56	66	71	68	55	43	53	63

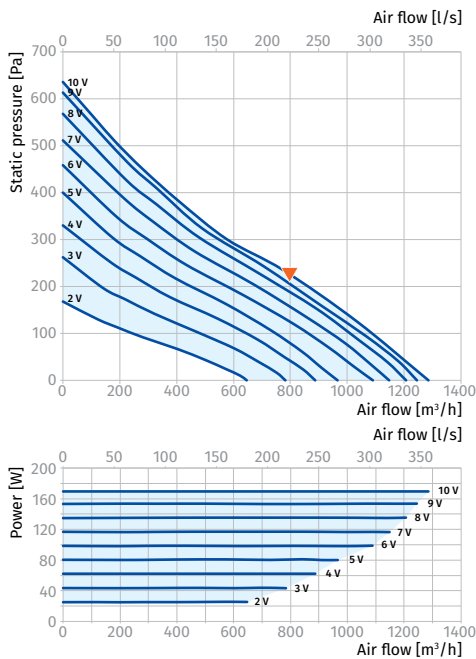

TURBO EC 315

Sound power level, A-weighted ▼	Total	Octave frequency bands [Hz]								LpA 3 m	LpA 1 m
		63	125	250	500	1000	2000	4000	8000		
LWA to inlet [dBA]	81	42	54	64	74	78	75	70	63	61	70
LWA to outlet [dBA]	83	43	54	72	77	78	78	73	66	63	72
LWA to environment [dBA]	75	37	48	60	68	73	68	60	48	55	65

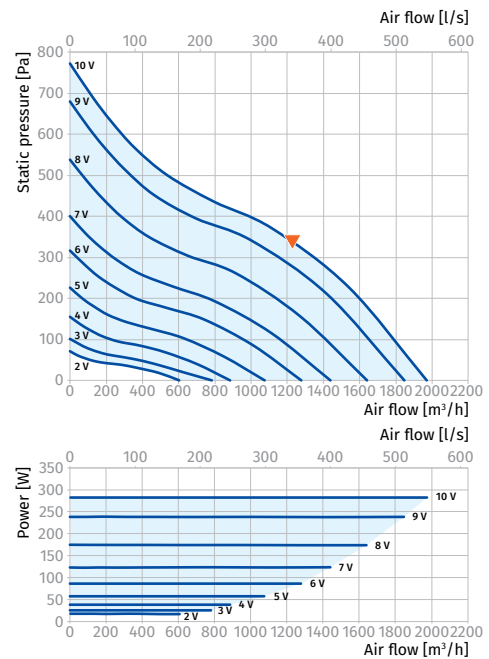

INLINE FANS

Ducto

Inline fans

Use

- Brand new low-noise axial inline fans for exhaust or supply ventilation with superior capacity up to 375 m³/h.
- Designed for PVC ducting systems or flexible ducts.
- From low to medium air flow motion for short distances at low air resistance.
- Compatible with Ø 100, 125 and 150 mm air ducts.



Air flow:
up to 375 m³/h
104 l/s



Power:
from 4.5 W



Noise level:
from 22 dBA



Design

- The casing and the impeller are made of high-quality durable plastic.
- Specially designed mixed-flow impeller profile ensures high air flow and low noise level.
- Low energy usage from 4.5 W.
- The models of Blauberg Ducto Series are equipped with a single-phase motor and are available in single- or two speed modifications.
- The motors have thermal overheating protection for motor overload prevention.
- Motor on special anti-vibration connectors.

Options

- Ducto Plus:** reliable single-phase two speed motor.
- Ducto Power Plus:** two-speed high-powered motor.
- Ducto T:** modification with a regulated timer with the operating time from 2 to 30 minutes.
- Ducto W1:** modification with a power cord with IEC C14 electric plug.

Fixing bracket

- Ducto-U:** modification with a fixing bracket for flat surface mounting.



Ducto-U

Control

- Manual speed control with a room light switch. It is not included in the delivery package.
- Smooth speed control with a thyristor speed controller (see Accessories). Several fans may be connected to the same controller. The models with timer are not compatible with a speed controller.
- Automatic fan control with the timer **T** (built-in turn-off delay timer enables the fan operation within 2 to 30 minutes after the fan switching off).

Operation modes of fans with timer

- Updated automatic control of models **Ducto Plus 100 T, 125 T, 150 T** and **Ducto Power Plus 150 T** enables to set four operation modes. Changeover to another operation mode by means of by setting the DIP switch to a respective position.
 - Mode 1** (single-speed mode)
The fan is turned off by default. The fan starts operating with the 1st speed when the switch is closed.
 - Mode 2** (single-speed mode)
The fan is turned off by default. The fan starts operating with the 2nd speed when the switch is closed.
 - Mode 3** (two-speed mode)
The fan operates with the 1st speed by default. The fan switches to the 2nd speed when the switch is closed.
 - Mode 4** (automatic interval mode)
The fan operates at the 1st speed by default. Each set time (adjustable from 1 to 15 hours) the fan switches to the 2nd speed automatically and reverts back to 1st speed after 2–30 minutes operation with maximum capacity.

Overall dimensions and mounting

- The fan is mounted into a matching duct size. Fastening with clamps in case of flexible duct connection.
- The mounting bracket enables installation of the fan on horizontal and vertical flat surfaces (**Ducto-U** model).
- Two fans can be installed in series for higher operation pressure.

Designation key

Series	Motor	Fixing bracket	Spigot diameter	Options
Ducto	Plus; Power Plus	-U	125	T; W1

Accessories

Air disc valves	Duct system	Flexible air ducts	Grilles and hoods	Speed controllers	Clamps
					
VPR / VSR / VMR	BlauPlast	BlauFlex	Decor / GM	CDT E1.8	K / KZ

Overall dimensions [mm]

Type	Ø D	L	K	Weight [kg]
Ducto 100	100	137.5	-	0.61
Ducto-U 100	100	137.5	53.5	0.61
Ducto 125	125	161.5	-	0.75
Ducto-U 125	125	161.5	53.5	0.75
Ducto 150	150	181.5	-	1.3
Ducto-U 150	150	181.5	53.5	1.3

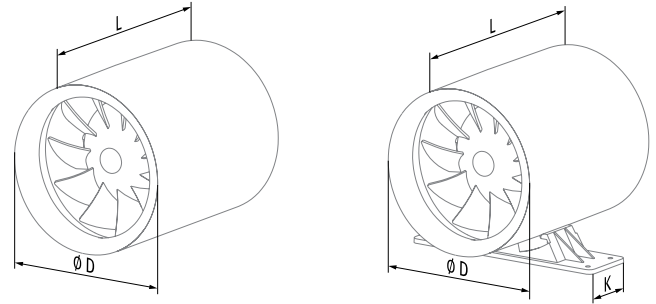

Ducto

Ducto-U

Technical data

Model	Ducto 100	Ducto Plus 100	Ducto 125	Ducto Plus 125	Ducto 150	Ducto Plus 150	Ducto Power Plus 150
Speed	-	min max	-	min max	-	min max	min max
Voltage [V]	220-240	220-240	220-240	220-240	220-240	220-240	220-240
Frequency [Hz]	50	50	50	50	50	50	50
Power [W]	7.5	4.5 7.5	13	10 13	22	19 22	22 25
Current [A]	0.049	0.029 0.049	0.085	0.065 0.085	0.095	0.087 0.095	0.103 0.109
Air flow [m³/h (l/s)]	110 (31)	75 (21) 110 (31)	215 (60)	155 (43) 215 (60)	340 (94)	250 (69) 340 (94)	285 (79) 375 (104)
RPM [min⁻¹]	2100	1650 2100	2250	1950 2250	2250	1950 2250	2300 2600
Noise level [dBA]	25	22 25	33	29 33	39	36 39	38 41

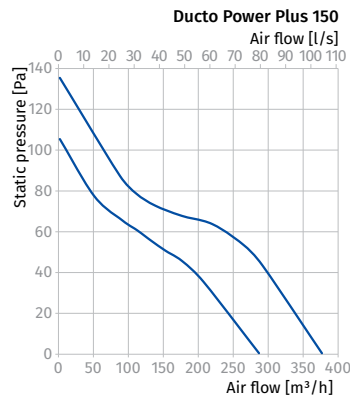
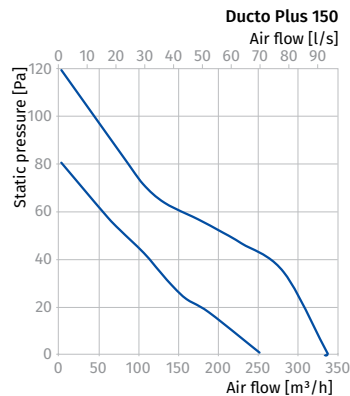
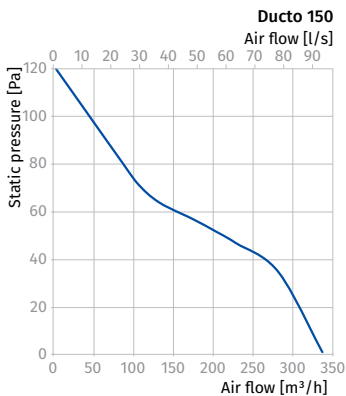
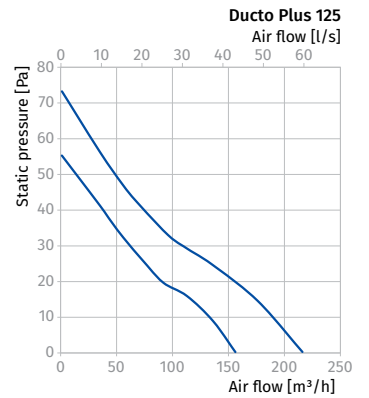
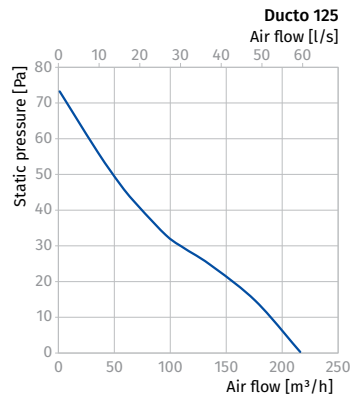
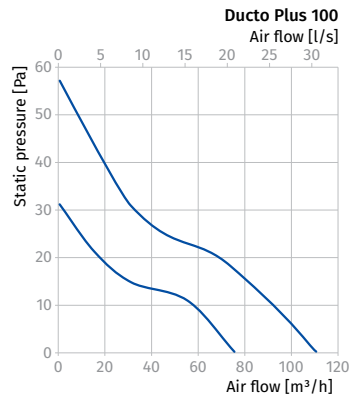
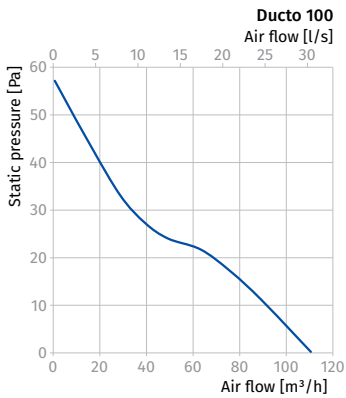

INLINE FANS

Primo

Inline mixed flow fans

Use

- Inline fans for supply and exhaust ventilation of various commercial and industrial premises requiring powerful air flow.
- The fans are compatible with Ø 355 and 400 mm air ducts.
- Combines wide capabilities and high performance features of axial and centrifugal fans, providing powerful air flow.



Air flow:
up to 3350 m³/h
931 l/s



Power:
from 126 W



Noise level:
from 47 dBA



Design

- The fan casing is made of polymer and reinforced with a metal housing. Due to the conically shaped polymer impeller with specially profiled blades, the air stream circular velocity increases, which results in higher air flow and pressure, as compared to characteristics of standard axial fans.
- The specially designed diffuser, impeller and airflow rectifier at the fan outlet provide smooth air flow distribution and enable the best combination of high capacity, powerful pressure and low noise.
- The fan casing is equipped with an airtight terminal box for connection to power mains.

Motor

- Equipped with three-speed four-pole asynchronous motors.
- 220–240 V single phase at 50 Hz.
- Equipped with ball bearings for longer service life (up to 40 000 hours).
- All motors have manual reset thermal overload protection.

Overall Dimensions [mm]

Model	Ø D	Ø D1	H	H1	L	W
Primo 355	355	406	408	439	372	566
Primo 400	400	451	453	484	415	623

Speed control

- The fans are controlled by either a three-stage **CDPE-3 E5** controller or a smooth thyristor controller connected to the maximum speed terminal.

Mounting

- The fans can be mounted at any place and at any angle within the ductwork system. Several fans may be installed in one system in parallel to attain higher air capacity or in series to increase operating pressure in the system. The fan casing is equipped with fixing brackets for suspended mounting.
- The fans can be mounted using a **UM Primo** bracket of the appropriate size (ordered separately).

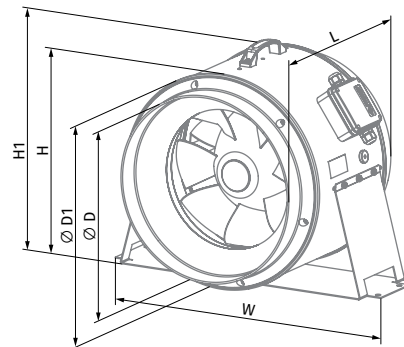

Designation key

Series	Duct diameter [mm]
Primo	355; 400

Modifications

- US:** three-speed switch
- FR1:** smooth speed controller adjustable from 0 to 100%
- G1:** speed controller, temperature controller with external temperature sensor, power cable with mains plug
- W1:** power cable with mains plug

Technical data

Parameters	Primo 355			Primo 400			
	min	mid	max	min	mid	max	
Speed							
Voltage [V / 50 Hz]		1~ 230			1~ 230		
Power [W]	126	131	150	197	204	224	
Current [A]	0.60	0.58	0.66	0.91	0.90	0.98	
Maximum air flow [m³/h (l/s)]	2090 (581)	2296 (638)	2485 (690)	2677 (744)	3136 (871)	3350 (931)	
RPM [min ⁻¹]	1350	1400	1470	1320	1390	1446	
Sound pressure at 3 m [dBA]	38	38	43	40	42	43	
Transported air temperature [°C]		-25...+55			-25...+55		
Protection rating		IPX4			IPX4		
Motor protection rating		IP44			IP44		
ErP compliance		2018			2018		

PRIMO 355

Sound power level, A-weighted	Total	Octave frequency bands [Hz]								LpA 3 m	LpA 1 m
		63	125	250	500	1000	2000	4000	8000		
L _{WA} to inlet [dBA]	69	50	61	63	60	63	60	56	48	49	59
L _{WA} to outlet [dBA]	69	56	61	63	61	65	59	54	48	49	59
L _{WA} to environment [dBA]	63	42	49	61	53	57	50	46	35	43	53

PRIMO 400

Sound power level, A-weighted	Total	Octave frequency bands [Hz]								LpA 3 m	LpA 1 m
		63	125	250	500	1000	2000	4000	8000		
L _{WA} to inlet [dBA]	71	57	62	66	65	64	61	55	47	51	61
L _{WA} to outlet [dBA]	73	57	65	63	67	68	63	59	51	52	62
L _{WA} to environment [dBA]	64	45	52	53	57	60	54	48	38	43	53

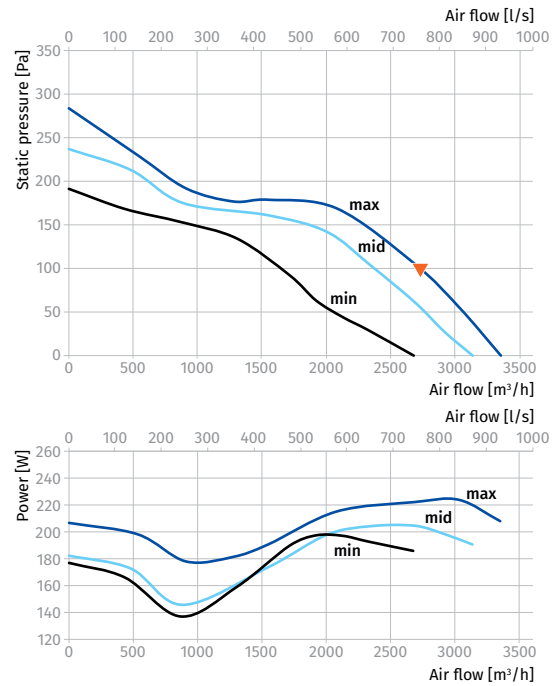
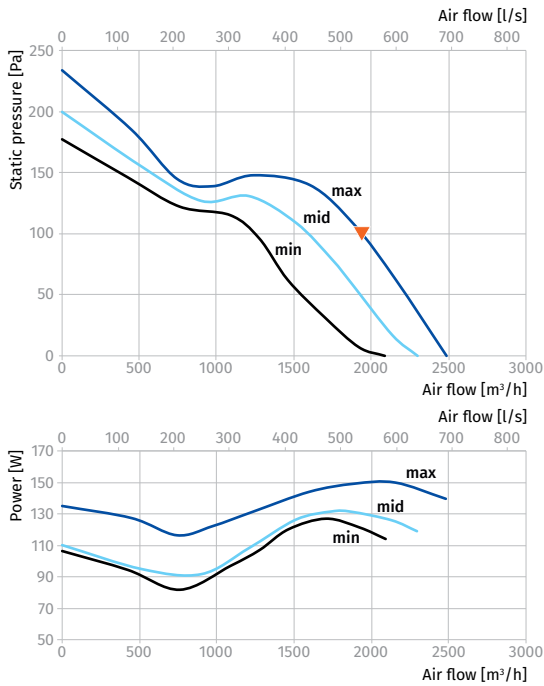

INLINE FANS

Primo EC

Inline mixed flow fans with AC and EC motors

Use

- Inline fans for supply and exhaust ventilation of various commercial and industrial premises requiring powerful air flow.
- The fans are compatible with Ø 355 and 400 mm air ducts.
- Combines wide capabilities and high performance features of axial and centrifugal fans, providing powerful air flow.



Air flow:
up to 5700 m³/h
1583 l/s



Power:
from 126 W



Noise level:
from 38 dBA



Design

- The fan casing is made of polymer and reinforced with a metal housing. Due to the conically shaped polymer impeller with specially profiled blades, the air stream circular velocity increases, which results in higher air flow and pressure, as compared to characteristics of standard axial fans.
- The specially designed diffuser, impeller and airflow rectifier at the fan outlet provide smooth air flow distribution and enable the best combination of high capacity, powerful pressure and low noise.
- The fan casing is equipped with an airtight terminal box for connection to power mains.

Motor

- Equipped with energy efficient EC motors.
- 220–240 V single phase at 50 Hz.
- Equipped with ball bearings for longer service life (up to 40 000 hours).
- All motors have manual reset thermal overload protection.

Overall Dimensions [mm]

Model	Ø D	Ø D1	H	H1	L	W
Primo EC 355	355	406	408	439	372	566
Primo EC 400	400	451	453	484	415	623

Speed control

- The fan speed is regulated by a smooth 0-10 V controller.

Mounting

- The fans can be mounted at any place and at any angle within the ductwork system. Several fans may be installed in one system in parallel to attain higher air capacity or in series to increase operating pressure in the system. The fan casing is equipped with fixing brackets for suspended mounting.
- The fans can be mounted using a **UM Primo** bracket of the appropriate size (ordered separately).

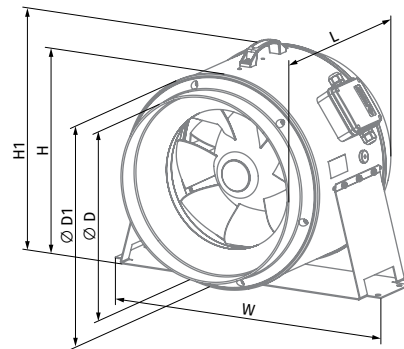

Designation key

Series	Motor type	Duct diameter [mm]	Modifications
Primo	EC: electronically commutated motor	355; 400	FR1: smooth speed controller adjustable from 0 to 100% G1: speed controller, temperature controller with external temperature sensor, power cable with mains plug W1: power cable with mains plug

Technical Data

Parameters	Primo EC 355	Primo EC 355 max	Primo EC 400
Voltage [V / 50 Hz]	1~ 230	1~ 230	1~ 230
Power [W]	346	701	726
Current [A]	1.54	3.10	3.23
Maximum air flow [m³/h (l/s)]	3685 (1024)	4630 (1286)	5700 (1583)
RPM [min⁻¹]	2470	3175	2580
Sound pressure at 3 m [dBA]	33-63	35-68	33-66
Transported air temperature [°C]	-25...+55	-25...+55	-25...+55
Protection rating	IPX4	IPX4	IPX4
Motor protection rating	IP44	IP44	IP44
Erp compliance	2018	2018	2018

PRIMO EC 355

Sound power level, A-weighted	Total	Octave frequency bands [Hz]							LpA 3 m	LpA 1 m	
		63	125	250	500	1000	2000	4000			8000
LWA to inlet [dBA]	83	73	76	75	75	78	74	69	61	63	73
LWA to outlet [dBA]	85	70	79	75	77	81	76	71	64	65	75
LWA to environment [dBA]	76	56	64	67	70	71	68	63	53	55	65

PRIMO EC 355 MAX

Sound power level, A-weighted	Total	Octave frequency bands [Hz]							LpA 3 m	LpA 1 m	
		63	125	250	500	1000	2000	4000			8000
LWA to inlet [dBA]	88	74	82	79	79	83	80	75	66	68	78
LWA to outlet [dBA]	90	72	83	79	81	86	82	77	70	70	80
LWA to environment [dBA]	80	45	63	66	73	77	74	68	57	60	70

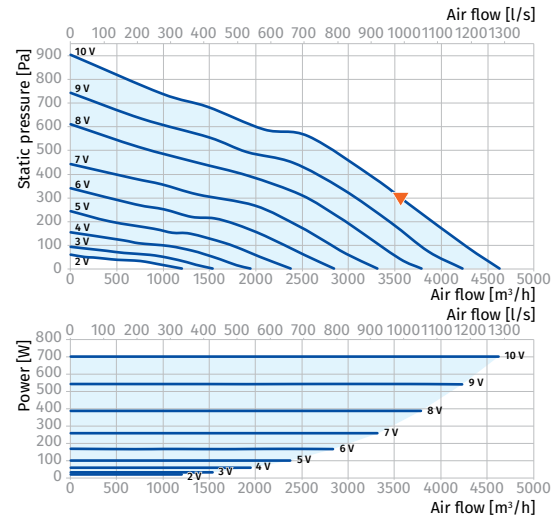
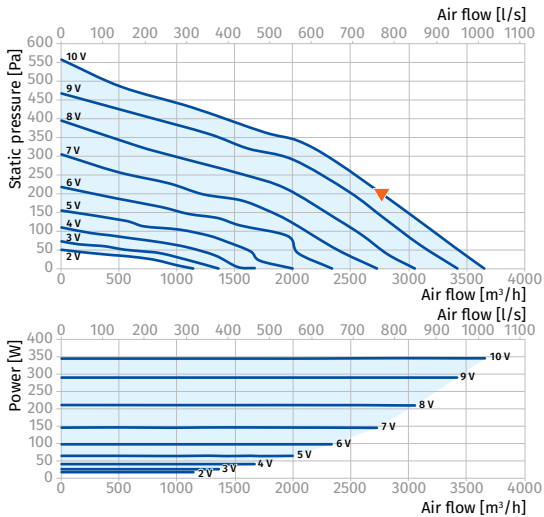

PRIMO EC 400

Sound power level, A-weighted	Total	Octave frequency bands [Hz]							LpA 3 m	LpA 1 m	
		63	125	250	500	1000	2000	4000			8000
LWA to inlet [dBA]	87	70	77	78	81	81	79	74	67	66	76
LWA to outlet [dBA]	88	62	76	78	83	84	80	75	66	68	78
LWA to environment [dBA]	80	59	66	69	74	77	72	67	58	60	70

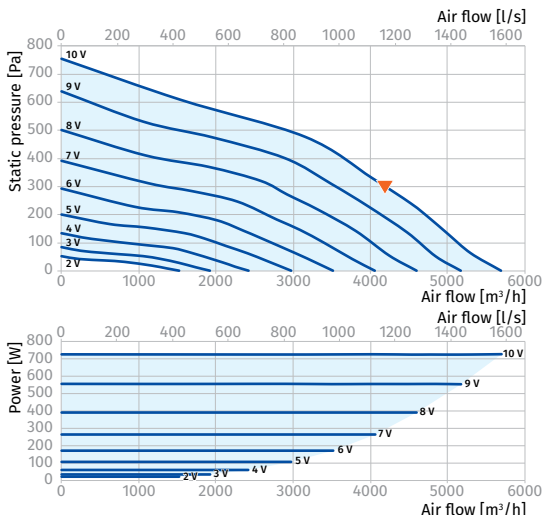

INLINE FANS

Centro (V2)

Inline centrifugal fans

Use

- Supply and extract ventilation systems installed in various premises.
- Mounting in kitchens, bathrooms and other humid premises.
- Compatible with Ø 100 up to 315 mm round air ducts.



Air flow:
up to 1700 m³/h
472 l/s



Power:
from 45 W



Noise level:
from 36 dBA



Design

- High-quality durable plastic casing.
- Aerodynamically shaped casing.
- Airtight mounting box.
- Centro 150** is compatible with 150 and 160 mm air ducts.

Motor

- Single-phase external rotor motor with a centrifugal impeller with backward curved blades.
- Equipped with ball bearings for longer service life.
- Integrated thermal protection with automatic restart.
- Dynamically balanced impeller.
- Some standard sizes have high-powered motors (**Centro max**).
- For ventilation of premises with high requirements to noise level low-noise modifications are available (**Centro L**).
- Centro V2** is equipped with the two-speed asynchronous motor with external rotor and centrifugal dynamically balanced impeller with backward curved blades.

Speed control

- Smooth speed control with a built-in electronic speed controller (option **FR1**).
- Smooth speed control with an external thyristor controller or step speed control with an external auto transformer (both available upon separate order).
- Centro V2** series: two-speed control with the external **CDP-2/5** or **CDP-2/10** speed switch (available upon separate order).

Mounting

- Due to compact design the fan is the ideal solution for mounting in limited spaces.
- Any mounting position.
- Wall or ceiling mounting with fixing brackets supplied as a standard or with a wire frame **Halter Centro** (available upon separate order).
- Flexible air ducts are fixed on the fan spigots with clamps.



Modifications and options

- max:** high-powered motor.
- L:** low-powered and low-noise motor.
- FR1:** smooth speed controller adjustable from 0 to 100 % and power cable with mains plug.



- G1:** speed controller, temperature controller with external temperature sensor (cable length 4 m), power cable with mains plug.
- G1I:** speed controller, temperature controller with integrated temperature sensor and power cable with mains plug.
- The **G1** and **G1I** modifications enable automatic speed control depending on indoor temperature. The optimal ventilation solution for premises requiring permanent temperature control as greenhouses, orangeries, etc.



- V:** built-in speed switch (for two-speed models).
- W1:** power cable with mains plug.

Accessories

Silencers	Filter boxes	Electric heaters	Water heaters	Backdraft air dampers	Air dampers	Speed controllers
						
SD	KFBK / KFBT	EKH	WKH	VRV	VK / VKA	CDT E1.8 / CDP-2/5(10)

Designation key			
Series	Duct diameter [mm]	Motor modifications	Options
Centro	100; 125; 150*; 200; 250; 315	max: high-powered motor L: low-powered motor V2: two-speed motor	V: built-in speed switch (for two-speed models) FR1: smooth speed controller adjustable from 0 to 100 % and power cable with mains plug G1: speed controller, temperature controller with external temperature sensor, power cable with mains plug G11: speed controller, temperature controller with integrated temperature sensor and power cable mains plug W1: power cable with mains plug

* Centro 150 (V2) model is compatible with the air ducts both \varnothing 150 and 160 mm

Overall dimensions [mm]

Type	\varnothing D	\varnothing D1	B	L	L1	L2	L3	Weight [kg]
Centro 100 L / Centro 100 / Centro 100 V2	100	250	270	230	30	27	30	2.22
Centro 125 L / Centro 125 / Centro 125 V2	125	250	270	220	30	27	30	2.20
Centro 150 / Centro 150 V2	150/160	300	310	286	30	30	30	2.45
Centro 200 / Centro 200 max / Centro 200 V2	200	340	354	276	30	30	40	3.00
Centro 250 L / Centro 250 / Centro 250 V2	250	340	354	265	30	30	40	4.30
Centro 315 / Centro 315 V2	315	400	414	276	40	55	40	4.85
Centro 315 max / Centro 315 max V2	315	400	414	276	40	55	40	4.85

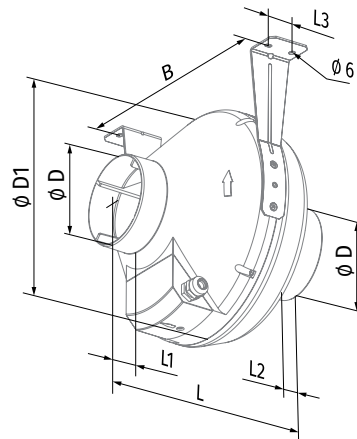

Technical data

Parameters	Centro 100 L		Centro 100		Centro 125 L		Centro 125	
Voltage [V]	1 ~ 230		1 ~ 230		1 ~ 230		1 ~ 230	
Frequency [Hz]	50	60	50	60	50	60	50	60
Power [W]	62	63	80	81	61	64	79	81
Current [A]	0.38	0.38	0.34	0.34	0.38	0.4	0.34	0.35
Maximum air flow [m ³ /h (l/s)]	205 (57)	210 (58)	250 (69)	290 (81)	260 (72)	270 (75)	355 (99)	370 (103)
RPM [min ⁻¹]	2650	2710	2820	2890	2610	2680	2800	2830
Sound pressure at 3 m [dBA]	36	36	40	41	36	37	40	41
Max. transported air temperature [°C]	-25...+55	-25...+50	-25...+55	-25...+50	-25...+55	-25...+50	-25...+55	-25...+50
SEC class	C	-	C	-	C	-	B	-
IP rating	IPX4		IPX4		IPX4		IPX4	
Motor IP rating	IP44		IP44		IP44		IP44	
ErP	2018		2018		2018		2018	

CENTRO 100 L, CENTRO 100

Sound power level, A-weighted	Total	Octave frequency bands [Hz]								LpA 3 m	LpA 1 m
		63	125	250	500	1000	2000	4000	8000		
Centro 100 L											
LWA to inlet [dBA]	77	55	69	75	67	62	58	52	42	56	66
LWA to outlet [dBA]	76	62	69	74	66	59	55	51	40	55	65
LWA to environment [dBA]	57	26	45	47	51	52	49	40	31	36	46
Centro 100											
LWA to inlet [dBA]	83	60	75	81	73	67	63	57	46	62	72
LWA to outlet [dBA]	82	67	75	80	72	64	60	55	44	61	71
LWA to environment [dBA]	61	28	49	51	55	57	53	44	34	40	50

CENTRO 125 L, CENTRO 125

Sound power level, A-weighted	Total	Octave frequency bands [Hz]								LpA 3 m	LpA 1 m
		63	125	250	500	1000	2000	4000	8000		
Centro 125 L											
LWA to inlet [dBA]	78	52	70	76	67	63	60	55	46	57	67
LWA to outlet [dBA]	77	59	70	75	66	60	58	53	45	56	66
LWA to environment [dBA]	56	27	40	48	51	50	50	40	28	36	46
Centro 125											
LWA to inlet [dBA]	84	56	76	82	72	68	65	59	50	63	73
LWA to outlet [dBA]	83	63	76	81	71	65	62	57	49	62	72
LWA to environment [dBA]	60	29	44	52	55	54	54	44	31	40	50

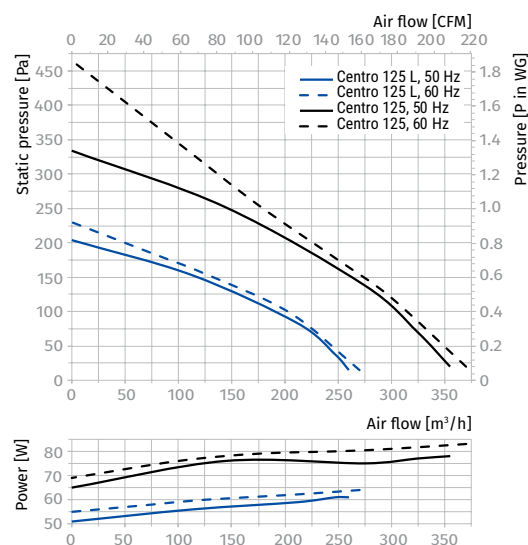
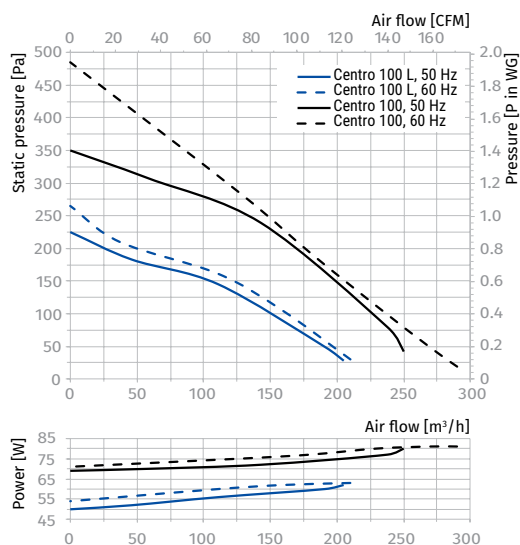

Parameters	Centro 150		Centro 200		Centro 200 max	
Voltage [V]	1 ~ 230		1 ~ 230		1 ~ 230	
Frequency [Hz]	50	60	50	60	50	60
Power [W]	80	84	107	132	173	216
Current [A]	0.35	0.37	0.47	0.58	0.76	0.94
Maximum air flow [m³/h (l/s)]	460 (128)	505 (140)	780 (217)	890 (247)	930 (258)	1020 (283)
RPM [min⁻¹]	2725	2840	2660	2765	2125	2155
Sound pressure at 3 m [dBA]	42	43	46	46	48	49
Max. transported air temperature [°C]	-25...+55	-25...+50	-25...+55	-25...+50	-25...+55	-25...+45
SEC class	B	-	B	-	B	-
IP rating	IPX4		IPX4		IPX4	
Motor IP rating	IP44		IP44		IP44	
ErP	2018		2018		2018	

CENTRO 150

Sound power level, A-weighted	Total	Octave frequency bands [Hz]								LpA 3 m	LpA 1 m
		63	125	250	500	1000	2000	4000	8000		
LWA to inlet [dBA]	90	53	87	86	75	74	71	68	54	69	79
LWA to outlet [dBA]	90	53	88	85	72	71	66	65	52	69	79
LWA to environment [dBA]	63	26	46	55	57	57	57	47	35	42	52

CENTRO 200, CENTRO 200 MAX

Sound power level, A-weighted	Total	Octave frequency bands [Hz]								LpA 3 m	LpA 1 m
		63	125	250	500	1000	2000	4000	8000		
Centro 200											
LWA to inlet [dBA]	85	47	74	81	77	77	78	70	59	65	75
LWA to outlet [dBA]	83	44	73	77	75	75	78	70	60	63	73
LWA to environment [dBA]	66	27	48	59	61	61	59	51	39	46	56
Centro 200 max											
LWA to inlet [dBA]	90	49	78	87	81	81	82	74	63	69	79
LWA to outlet [dBA]	87	46	77	81	79	79	82	74	64	67	77
LWA to environment [dBA]	68	29	52	60	63	63	62	53	39	48	58

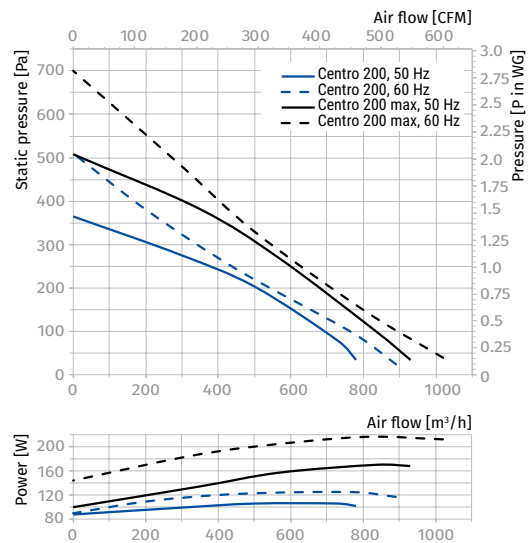
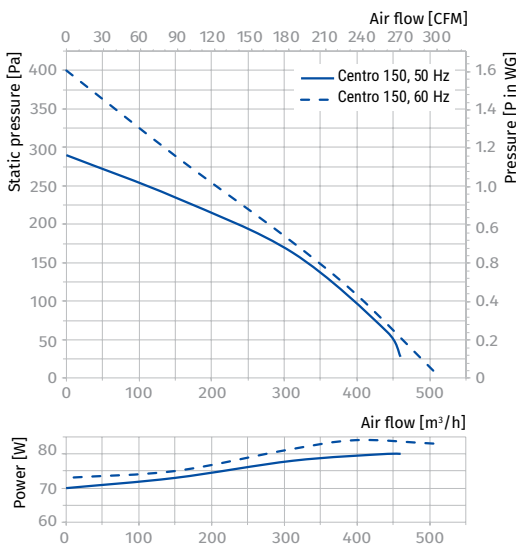

Parameters	Centro 250 L		Centro 250		Centro 315	Centro 315 max
Voltage [V]	1 ~ 230		1 ~ 230		1 ~ 230	1 ~ 230
Frequency [Hz]	50	60	50	60	50	50
Power [W]	108	135	173	207	200	310
Current [A]	0.47	0.59	0.76	0.9	0.88	1.36
Maximum air flow [m³/h (l/s)]	865 (240)	930 (258)	1080 (300)	1090 (303)	1340 (372)	1700 (472)
RPM [min ⁻¹]	2560	2570	2090	2120	2655	2590
Sound pressure at 3 m [dBA]	47	48	49	50	48	57
Max. transported air temperature [°C]	-25...+55	-25...+50	-25...+55	-25...+50	-25...+55	-25...+45
SEC class	B	-	B	-	-	-
IP rating	IPX4		IPX4		IPX4	IPX4
Motor IP rating	IP44		IP44		IP44	IP44
ErP	2018		2018		2018	2018

CENTRO 250 L, CENTRO 250

Sound power level, A-weighted	Total	Octave frequency bands [Hz]								LpA 3 m	LpA 1 m
		63	125	250	500	1000	2000	4000	8000		
Centro 250 L											
LWA to inlet [dBA]	89	53	76	74	78	84	85	80	70	69	79
LWA to outlet [dBA]	89	56	68	78	75	83	86	79	71	68	78
LWA to environment [dBA]	68	36	50	60	63	62	61	56	42	47	57
Centro 250											
LWA to inlet [dBA]	90	61	78	85	83	85	81	77	65	70	80
LWA to outlet [dBA]	88	64	77	73	82	84	82	77	63	68	78
LWA to environment [dBA]	69	35	49	61	64	64	62	50	39	49	59

CENTRO 315

Sound power level, A-weighted	Total	Octave frequency bands [Hz]								LpA 3 m	LpA 1 m
		63	125	250	500	1000	2000	4000	8000		
Centro 315											
LWA to inlet [dBA]	86	51	73	71	75	81	82	77	68	66	76
LWA to outlet [dBA]	87	55	66	76	73	81	84	77	69	66	76
LWA to environment [dBA]	69	30	48	59	63	65	62	52	38	48	58
Centro 315 max											
LWA to inlet [dBA]	93	56	80	78	82	88	89	84	74	73	83
LWA to outlet [dBA]	93	59	72	82	79	87	90	83	75	72	82
LWA to environment [dBA]	78	33	54	63	71	73	73	63	55	57	67

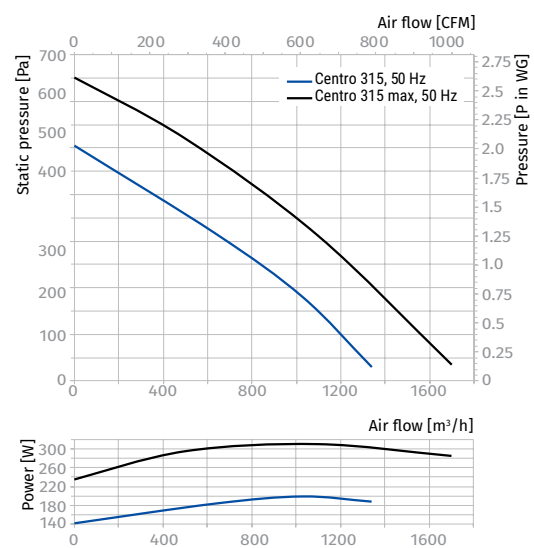
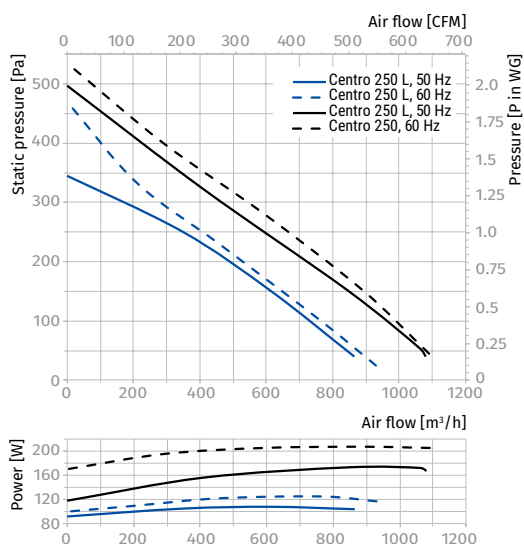

Parameters	Centro 100 V2		Centro 125 V2		Centro 150 V2		Centro 200 V2	
	min	max	min	max	min	max	min	max
Speed								
Voltage [V]	1 ~ 230		1 ~ 230		1 ~ 230		1 ~ 230	
Frequency [Hz]	50		50		50		50	
Power [W]	45	57	45	58	46	59	83	95
Current [A]	0.21	0.25	0.21	0.26	0.22	0.26	0.27	0.43
Maximum air flow [m³/h (l/s)]	157 (44)	264 (73)	191 (53)	329 (91)	264 (73)	445 (124)	430 (119)	741 (206)
RPM [min ⁻¹]	1820	2440	1810	2380	1805	2420	1920	2470
Sound pressure at 3 m [dBA]	38		39		40		42	
Transported air temperature [°C]	-25...+55		-25...+55		-25...+55		-25...+55	
SEC class	D		D		D		C	
IP rating	IPX4		IPX4		IPX4		IPX4	
Motor IP rating	IP44		IP44		IP44		IP44	
ErP	2018		2018		2018		2018	

CENTRO 100 V2

Sound power level, A-weighted	Total	Octave frequency bands [Hz]								LpA 3 m	LpA 1 m
		63	125	250	500	1000	2000	4000	8000		
LWA to inlet [dBA]	79	57	71	77	69	64	60	54	43	58	68
LWA to outlet [dBA]	79	64	72	77	69	61	57	53	42	58	68
LWA to environment [dBA]	58	27	46	48	53	54	50	41	32	38	48

CENTRO 125 V2

Sound power level, A-weighted	Total	Octave frequency bands [Hz]								LpA 3 m	LpA 1 m
		63	125	250	500	1000	2000	4000	8000		
LWA to inlet [dBA]	81	59	74	79	72	66	62	56	45	61	71
LWA to outlet [dBA]	79	64	72	77	69	61	58	53	42	58	68
LWA to environment [dBA]	59	27	48	49	53	55	51	43	33	39	49

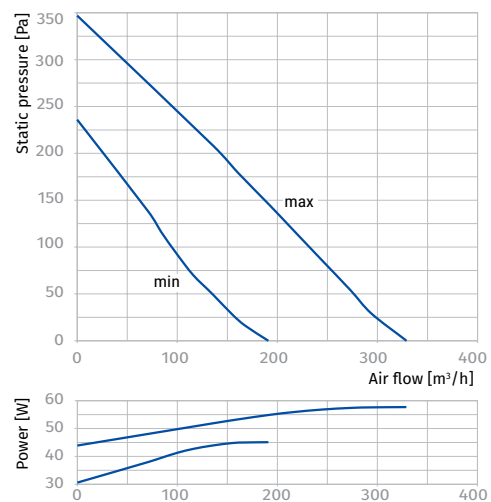
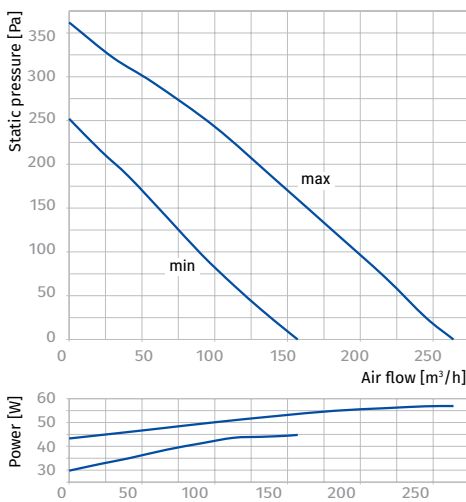

CENTRO 150 V2

Sound power level, A-weighted	Total	Octave frequency bands [Hz]								LpA 3 m	LpA 1 m
		63	125	250	500	1000	2000	4000	8000		
LWA to inlet [dBA]	88	52	85	84	74	73	70	67	53	67	77
LWA to outlet [dBA]	86	51	84	82	69	68	63	62	50	66	76
LWA to environment [dBA]	61	25	45	53	55	55	55	46	34	40	50

CENTRO 200 V2

Sound power level, A-weighted	Total	Octave frequency bands [Hz]								LpA 3 m	LpA 1 m
		63	125	250	500	1000	2000	4000	8000		
LWA to inlet [dBA]	81	45	70	77	73	73	74	67	56	61	71
LWA to outlet [dBA]	79	41	69	72	71	71	73	66	56	58	68
LWA to environment [dBA]	62	25	45	55	57	57	55	48	37	42	52

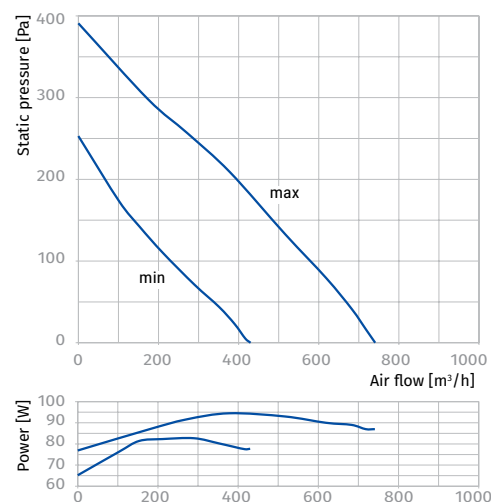
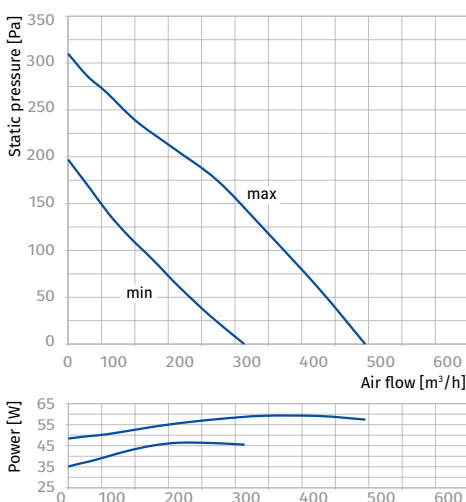

Parameters	Centro 250 V2		Centro 315 V2	
Speed	min	max	min	max
Voltage [V]	1 ~ 230		1 ~ 230	
Frequency [Hz]	50		50	
Power [W]	147	176	143	173
Current [A]	0.66	0.76	0.68	0.76
Maximum air flow [m ³ /h (l/s)]	642 (178)	1126 (313)	758 (211)	1268 (352)
RPM [min ⁻¹]	1940	2370	1870	2410
Sound pressure at 3 m [dBA]	46		48	
Transported air temperature [°C]	-25...+55		-25...+55	
SEC class	C		-	
IP rating	IPX4		IPX4	
Motor IP rating	IP44		IP44	
ErP	2018		-	

CENTRO 250 V2

Sound power level, A-weighted	Total	Octave frequency bands [Hz]								LpA 3 m	LpA 1 m
		63	125	250	500	1000	2000	4000	8000		
LWA to inlet [dBA]	86	51	73	71	75	81	82	77	67	66	76
LWA to outlet [dBA]	87	54	66	76	73	81	83	77	69	66	76
LWA to environment [dBA]	67	35	49	59	62	61	60	55	41	46	56

CENTRO 315 V2

Sound power level, A-weighted	Total	Octave frequency bands [Hz]								LpA 3 m	LpA 1 m
		63	125	250	500	1000	2000	4000	8000		
LWA to inlet [dBA]	90	54	77	75	79	85	86	81	71	70	80
LWA to outlet [dBA]	89	56	68	78	75	83	86	79	71	68	78
LWA to environment [dBA]	69	37	51	61	64	63	62	57	43	48	58

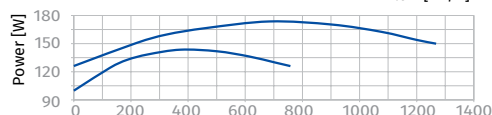
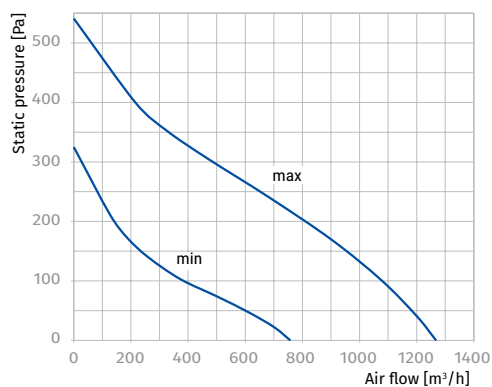
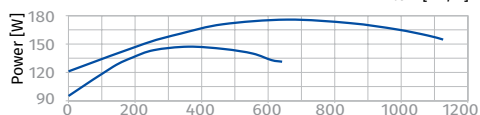
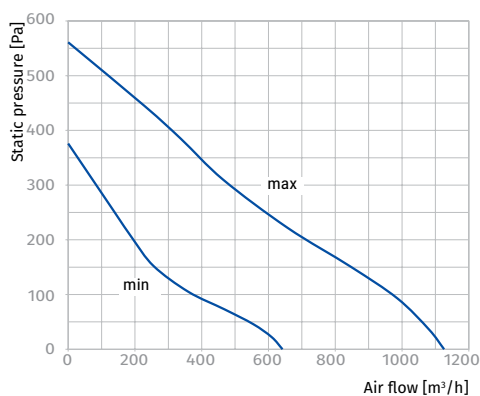

Centro EC

Inline centrifugal fans with EC motor

Use

- Supply and exhaust ventilation and air conditioning systems of various premises requiring cost-saving controllable ventilation.
- The best ventilation solution for exhaust ventilation of bathrooms, kitchens and other humid premises.
- Compatible with Ø 100 up to 315 mm round air ducts.



Air flow:
up to 1500 m³/h
417 l/s



Power:
from 82 W



Noise level:
from 40 dBA



Design

- Durable, impact-resistant and corrosion-free ABS-plastic casing.
- Aerodynamically shaped casing.
- Airtight terminal box for connection to power mains.

Motor

- High-efficient direct current EC motor with external rotor and backward curved blades.
- EC technology meets the up-to-date requirements to energy-saving and controllable ventilation and provides up to 35 % energy saving as compared to asynchronous motors.
- EC motor ensures totally controllable speed range for the fan and has integrated overheating protection with automatic restart.
- EC motor has no friction and wearing parts as capacitor and brushes. Instead a maintenance-free EC controller electronic circuit board is used.
- The impeller is dynamically balanced.
- The fan is compatible with 50 Hz and 60 Hz power mains and the maximum speed does not depend on power mains frequency.

Speed control

- The fan speed is controlled with a 0-10 V control signal from the following sources:
 - integrated or external speed controller
 - controller with sensors
 - central BMS system.
- The control signal value changes depending on air temperature, pressure, smoke concentration and other parameters.
- During signal value change the fan with EC motor correspondingly changes the rotations speed and delivers required air volume to the ventilation system.
- The computer central building management systems (BMS) enable integration of several EC motors in network and precise individual operation control for each fan.

Mounting

- The fans are designed for duct mounting in any point of the ventilation system with the casing mounted at any angle. In case of vertical mounting a protective outer hood must be installed on the top.
- Fixation to the floor wall or ceiling is performed with the supplied mounting brackets.
- Electric connection and installation must be performed in compliance with the manual and the wiring diagram on the terminal box.



Mounting bracket for easy installation supplied with the fan

Modifications and options

- FR1:** smooth speed controller adjustable from 0 to 100 % and power cable with mains plug.



Centro EC FR1 with an integrated speed controller and power cable

Accessories

Silencers	Filter boxes	Electric heaters	Water heaters	Backdraft air dampers	Air dampers	Speed controllers
						
SD	KFBK / KFBT	EKH	WKH	VRV	VK / VKA	CDT E/0-10



- **G1**: speed controller, temperature controller with external temperature sensor (cable length 4 m), power cable with mains plug.
- **G11**: speed controller, temperature controller with integrated temperature sensor and power cable with mains plug. The **G1** and **G11** modifications enable automatic speed control depending on indoor temperature. The optimal ventilation solution for premises requiring permanent temperature control as greenhouses, orangeries, etc.
- **W1**: power cable with mains plug.

Designation key			
Series	Motor	Spigot diameter [mm]	Options
Centro	EC: electronically commutated motor	100; 125; 150; 200; 250; 315	FR1 : smooth speed controller adjustable from 0 to 100 % and power cable with mains plug G1 : speed controller, temperature controller with external temperature sensor, power cable with mains plug G11 : speed controller, temperature controller with integrated temperature sensor and power cable mains plug W1 : power cable with mains plug

Overall dimensions [mm]

Model	∅ D	∅ D1	B	L	L1	L2	L3	Weight [kg]
Centro EC 100	100	250	270	230	30	27	30	2.0
Centro EC 125	125	250	270	220	30	27	30	2.2
Centro EC 150	150/160	300	310	286	30	30	30	2.5
Centro EC 200	200	340	354	276	30	30	40	3.0
Centro EC 250	250	340	354	265	30	30	40	4.3
Centro EC 315	315	400	414	276	40	55	40	4.9

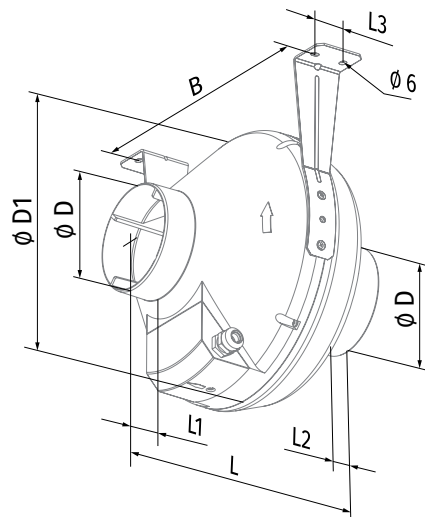

Technical data

Parameters	Centro EC 100	Centro EC 125	Centro EC 150
Voltage [V]	1 ~ 230	1 ~ 230	1 ~ 230
Frequency [Hz]	50	50	50
Power [W]	82	84	82
Current [A]	0.62	0.64	0.63
Maximum air flow [m ³ /h (l/s)]	340 (94)	420 (117)	630 (175)
RPM [min ⁻¹]	3400	3600	3400
Sound pressure level at 3 m [dBA]	40	42	45
Transported air temperature [°C]	-25...+60	-25...+60	-25...+60
SEC class	B	B	B
IP rating	IPX4	IPX4	IPX4
Motor IP rating	IP44	IP44	IP44
ErP	2018	2018	2018

CENTRO EC 100

Sound power level, A-weighted	Total	Octave frequency bands [Hz]								LpA 3 m	LpA 1 m
		63	125	250	500	1000	2000	4000	8000		
L _{WA} to inlet [dBA]	85	62	77	83	75	69	65	59	48	64	74
L _{WA} to outlet [dBA]	84	69	77	82	74	66	62	57	46	63	73
L _{WA} to environment [dBA]	61	29	44	52	56	55	54	44	31	40	50

Point	Power [W]	Point	Power [W]
1	82	11	28
2	82	12	25
3	81	13	17
4	81	14	16
5	51	15	15
6	50	16	13
7	45	17	8
8	40	18	8
9	32	19	7
10	30	20	6

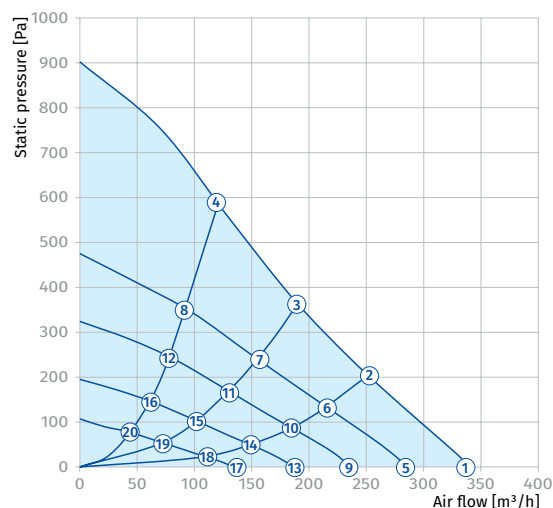

CENTRO EC 125

Sound power level, A-weighted	Total	Octave frequency bands [Hz]								LpA 3 m	LpA 1 m
		63	125	250	500	1000	2000	4000	8000		
L _{WA} to inlet [dBA]	87	59	79	86	75	71	68	62	52	67	77
L _{WA} to outlet [dBA]	86	66	79	85	74	68	65	60	50	66	76
L _{WA} to environment [dBA]	62	26	46	55	56	57	57	47	35	42	52

Point	Power [W]	Point	Power [W]
1	84	11	29
2	82	12	24
3	82	13	18
4	81	14	17
5	51	15	16
6	50	16	14
7	48	17	8
8	45	18	8
9	31	19	7
10	30	20	7

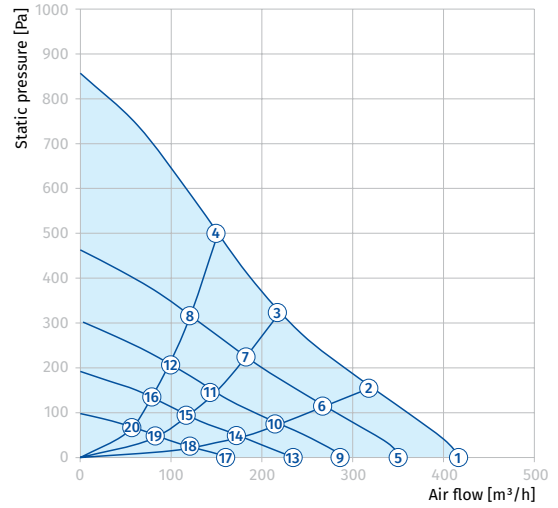

CENTRO EC 150

Sound power level, A-weighted	Total	Octave frequency bands [Hz]								LpA 3 m	LpA 1 m
		63	125	250	500	1000	2000	4000	8000		
L _{WA} to inlet [dBA]	93	55	90	89	77	76	73	70	56	72	82
L _{WA} to outlet [dBA]	93	55	91	88	74	73	68	67	54	72	82
L _{WA} to environment [dBA]	66	26	48	58	61	60	59	51	39	45	55

Point	Power [W]	Point	Power [W]
1	82	11	31
2	82	12	27
3	82	13	17
4	82	14	17
5	54	15	17
6	57	16	16
7	53	17	9
8	49	18	9
9	32	19	8
10	33	20	8

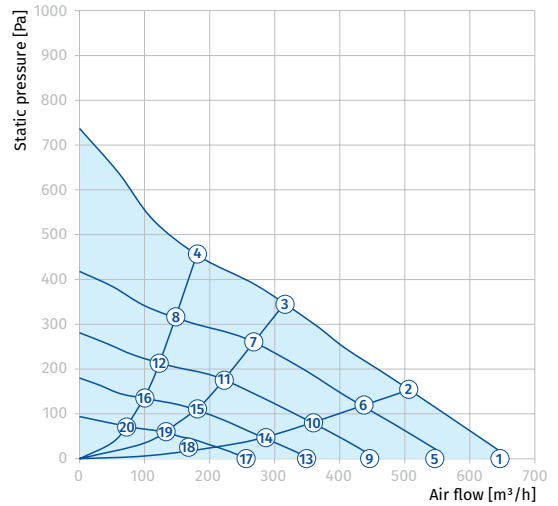

Parameters	Centro EC 200	Centro EC 250	Centro EC 315
Voltage [V]	1 ~ 230	1 ~ 230	1 ~ 230
Frequency [Hz]	50	50	50
Power [W]	84	165	165
Current [A]	0.64	1.1	1.15
Maximum air flow [m ³ /h (l/s)]	885 (246)	1250 (347)	1500 (417)
RPM [min ⁻¹]	2700	2600	2500
Sound pressure level at 3 m [dBA]	47	48	48
Transported air temperature [°C]	-25...+60	-25...+60	-25...+60
SEC class	B	-	-
IP rating	IPX4	IPX4	IPX4
Motor IP rating	IP44	IP44	IP44
ErP	2018	2018	2018

CENTRO EC 200

Sound power level, A-weighted	Total	Octave frequency bands [Hz]								LpA 3 m	LpA 1 m
		63	125	250	500	1000	2000	4000	8000		
L _{WA} to inlet [dBA]	87	48	76	84	79	79	80	72	61	67	77
L _{WA} to outlet [dBA]	85	45	75	79	77	77	80	72	62	64	74
L _{WA} to environment [dBA]	67	27	49	60	62	61	60	52	39	47	57

Point	Power [W]	Point	Power [W]
1	84	11	32
2	84	12	31
3	83	13	16
4	82	14	18
5	51	15	18
6	54	16	17
7	58	17	8
8	55	18	8
9	28	19	9
10	32	20	8

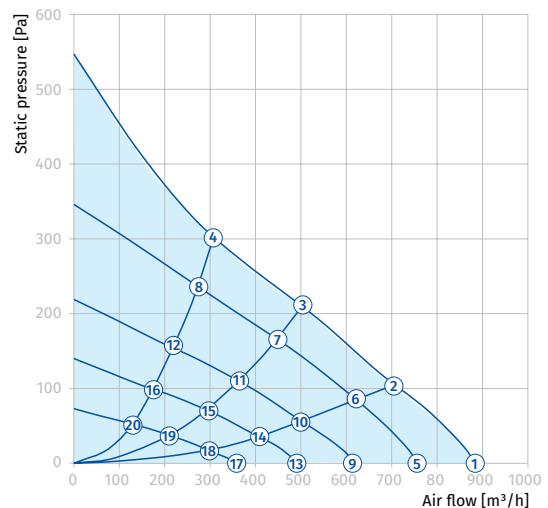

CENTRO EC 250

Sound power level, A-weighted	Total	Octave frequency bands [Hz]								LpA 3 m	LpA 1 m
		63	125	250	500	1000	2000	4000	8000		
L _{WA} to inlet [dBA]	89	60	77	84	82	84	80	76	64	69	79
L _{WA} to outlet [dBA]	87	63	76	72	81	83	81	76	62	67	77
L _{WA} to environment [dBA]	68	30	49	58	62	65	61	52	38	48	58

Point	Power [W]	Point	Power [W]
1	152	11	89
2	161	12	78
3	165	13	37
4	154	14	40
5	121	15	43
6	131	16	38
7	140	17	16
8	125	18	17
9	76	19	18
10	83	20	16

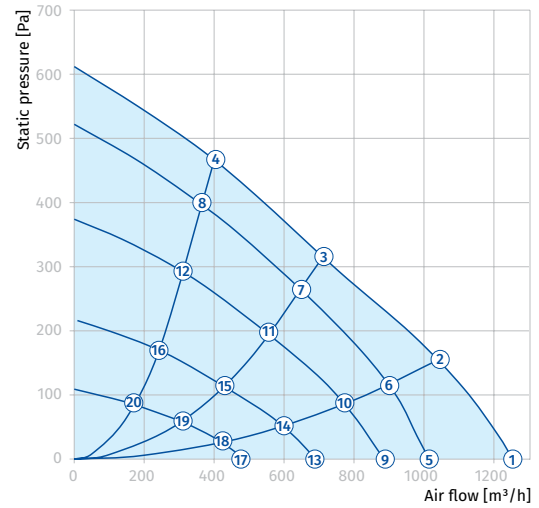

CENTRO EC 315

Sound power level, A-weighted	Total	Octave frequency bands [Hz]								LpA 3 m	LpA 1 m
		63	125	250	500	1000	2000	4000	8000		
L _{WA} to inlet [dBA]	86	51	73	71	75	81	82	77	68	66	76
L _{WA} to outlet [dBA]	87	55	66	76	73	81	84	77	69	67	77
L _{WA} to environment [dBA]	69	30	48	56	62	64	64	56	49	48	58

Point	Power [W]	Point	Power [W]
1	149	11	90
2	164	12	84
3	165	13	37
4	158	14	39
5	94	15	45
6	106	16	41
7	112	17	17
8	104	18	19
9	74	19	19
10	83	20	17

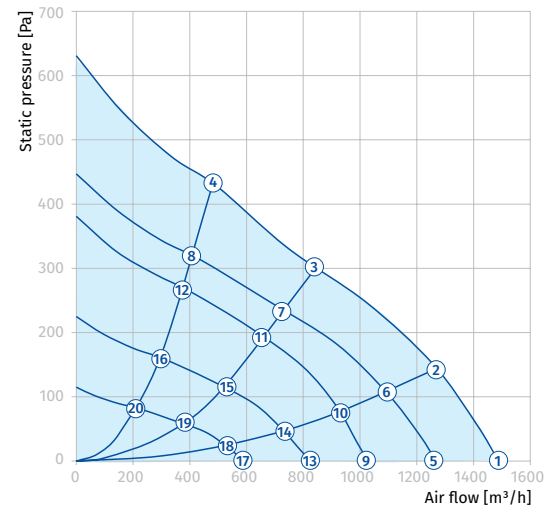

Centro-M

Inline centrifugal fans

Use

- Supply and extract ventilation systems installed in various premises.
- Direct mounting inside air ductworks.
- Compatible with Ø 100 to 450 mm round air ducts.



Air flow:
up to 6280 m³/h
1745 l/s



Power:
from 45 W



Noise level:
from 38 dBA



Design

- The casing is made of steel with a special polymer coating.
- Aerodynamically shaped casing.
- External terminal box for connection to power mains.

Motor

- Single-phase external rotor motor with a centrifugal impeller with backward curved blades.
- Equipped with ball bearings for longer service life.
- Overheat protection with built-in thermal switches with automatic restart.
- Dynamically balanced impeller.
- Some standard sizes have high-powered motors (**Centro-M max**).
- For ventilation of premises with high requirements to noise level low-noise modifications are available (**Centro-M L**).

Speed control

- Smooth speed control with an external thyristor controller or step speed control with an external auto transformer (both available upon separate order).

Mounting

- Any mounting position.
- The fans with the connecting diameter from 100 up to 315 mm are fixed to wall or ceiling with mounting brackets supplied as a standard.
- The fans with the connecting diameter from 355 up to 450 mm are fixed with mounting brackets fixed on the casing.
- Flexible air ducts are fixed on the fan spigots with clamps.

Modifications and options

- max:** high-powered motor.
- L:** low-powered and low-noise motor.
- E:** energy-efficient motor with low power consumption.
- FR1 (for standard sizes 100–315):** smooth speed controller adjustable from 0 to 100 % and power cable with mains plug.



- G1:** speed controller, temperature controller with external temperature sensor (cable length 4 m), power cable with mains plug.
- W1:** power cable with mains plug.



Centro-M 100 – Centro-M 315



Centro-M 355 – Centro-M 450

Accessories

Silencers



SD

Filter boxes



KFBK / KFBT

Electric heaters



EKH

Water heaters



WKH

Backdraft air dampers



VRV

Air dampers



VK / VKA

Speed controllers



CDT E1.8

INLINE FANS

Designation key			
Series	Duct diameter [mm]	Motor modifications	Options
Centro-M	100; 125; 150; 160; 200; 250; 315; 355; 400; 450	max: high-powered motor L: low-powered motor E: motor with low power consumption	FR1 (for standard sizes 100-315): smooth speed controller adjustable from 0 to 100 % and power cable with mains plug G1: speed controller, temperature controller with external temperature sensor, power cable with mains plug W1: power cable with mains plug

Overall dimensions [mm]

Type	∅ D	∅ D1	B	B1	L	L1	L2	L3	Weight [kg]
Centro-M 100 L	98	255	310	270	205	20	25	30	2.9
Centro-M 100	98	255	310	270	205	20	25	30	3.2
Centro-M 125 L	123	255	310	270	205	20	25	30	2.9
Centro-M 125	123	255	310	270	205	20	25	30	3.2
Centro-M 150	149	345	395	355	200	20	20	40	5.1
Centro-M 150 max	149	345	395	355	230	20	20	40	5.6
Centro-M 160	159	305	360	320	220	25	25	30	5.0
Centro-M 160 max	158	340	390	350	245	25	20	40	6.4
Centro-M 200	198	345	395	355	255	25	30	40	6.6
Centro-M 200 max	198	345	395	355	255	25	30	40	8.3
Centro-M 250 E	248	345	395	355	250	25	30	40	6.2
Centro-M 250	248	345	395	355	250	25	30	40	8.4
Centro-M 315	314	405	455	415	260	30	30	40	8.0
Centro-M 315 max	314	405	455	415	290	30	30	40	8.8
Centro-M 355 L	353	460	522	522	506	60	60	70	18.8
Centro-M 400	398	570	663	634	570	60	60	70	25.1
Centro-M 450	448	608	700	670	644	60	60	80	27.26

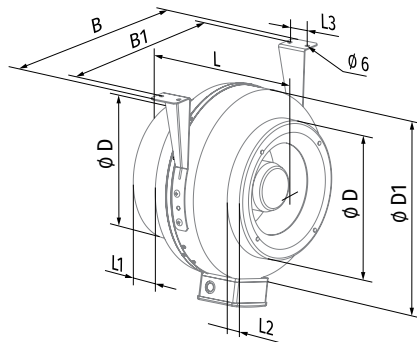

Centro-M 100 – Centro-M 315

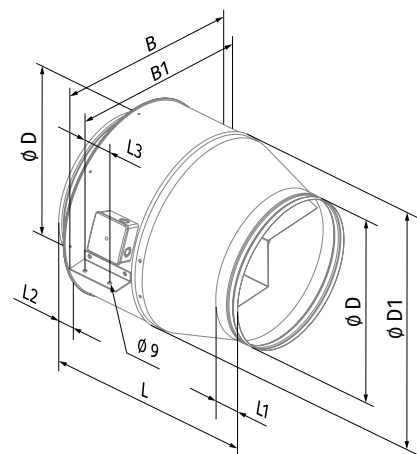

Centro-M 355 – Centro-M 450

Technical data

Parameters	Centro-M 100 L		Centro-M 100		Centro-M 125 L		Centro-M 125	
Voltage [V]	1 ~ 230		1 ~ 230		1 ~ 230		1 ~ 230	
Frequency [Hz]	50	60	50	60	50	60	50	60
Power [W]	45	50	60	82	47	54	64	85
Current [A]	0.24	0.23	0.28	0.36	0.25	0.24	0.29	0.37
Air flow [m³/h (l/s)]	233 (65)	267 (74)	279 (78)	278 (77)	326 (91)	370 (103)	360 (100)	357 (99)
RPM [min⁻¹]	2780	3300	2840	3320	2760	3240	2840	3300
Sound pressure level at 3 m [dBA]	38	39	40	41	37	38	40	42
Transported air temperature [°C]	-25...+45		-25...+45		-25...+45		-25...+45	
SEC class	C	-	C	-	C	-	C	-
IP rating	IPX4		IPX4		IPX4		IPX4	
Motor IP rating	IP44		IP44		IP44		IP44	
ErP	2018	-	2018	-	2018	-	2018	-

CENTRO-M 100 L, CENTRO-M 100

Sound power level, A-weighted	Total	Octave frequency bands [Hz]								LpA 3 m	LpA 1 m
		63	125	250	500	1000	2000	4000	8000		
Centro-M 100 L											
LWA to inlet [dBA]	78	56	70	77	68	63	59	53	43	58	68
LWA to outlet [dBA]	77	63	70	75	67	60	56	52	41	57	67
LWA to environment [dBA]	59	27	47	49	53	54	51	42	32	38	48
Centro-M 100											
LWA to inlet [dBA]	84	56	76	82	72	68	65	59	50	63	73
LWA to outlet [dBA]	83	63	76	81	71	65	62	57	49	62	72
LWA to environment [dBA]	60	29	44	52	55	54	54	44	31	40	50

CENTRO-M 125 L, CENTRO-M 125

Sound power level, A-weighted	Total	Octave frequency bands [Hz]								LpA 3 m	LpA 1 m
		63	125	250	500	1000	2000	4000	8000		
Centro-M 125 L											
LWA to inlet [dBA]	79	57	71	77	69	64	60	54	43	58	68
LWA to outlet [dBA]	78	64	71	76	68	61	57	53	41	58	68
LWA to environment [dBA]	58	27	46	48	52	53	50	41	32	37	47
Centro-M 125											
LWA to inlet [dBA]	83	60	75	81	73	67	63	57	46	62	72
LWA to outlet [dBA]	82	67	75	80	72	64	60	55	44	61	71
LWA to environment [dBA]	61	28	49	51	55	57	53	44	34	40	50

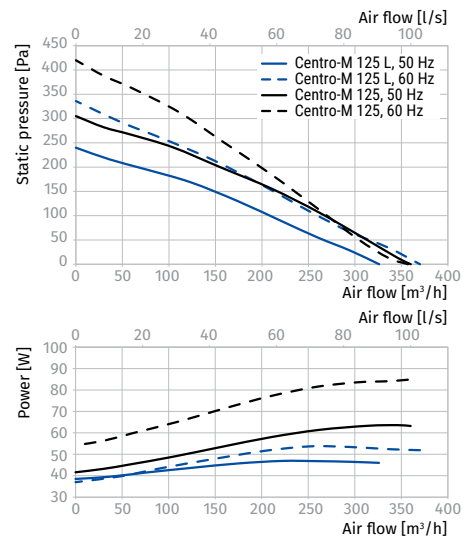
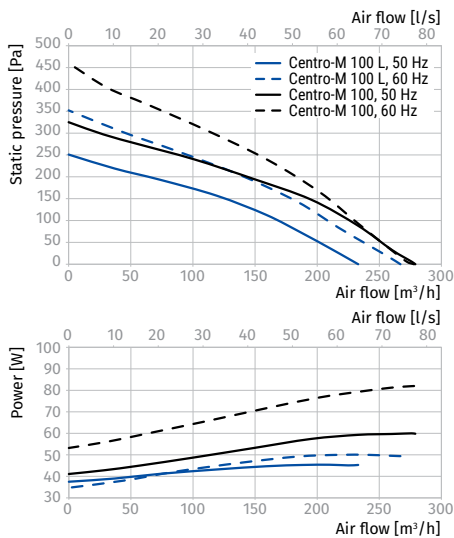

INLINE FANS

Parameters	Centro-M 150		Centro-M 150 max		Centro-M 160		Centro-M 160 max	
Voltage [V]	1 ~ 230		1 ~ 230		1 ~ 230		1 ~ 230	
Frequency [Hz]	50	60	50	60	50	60	50	60
Power [W]	100	125	127	174	99	137	121	170
Current [A]	0.45	0.55	0.55	0.76	0.44	0.61	0.53	0.75
Air flow [m³/h (l/s)]	580 (161)	610 (169)	710 (197)	750 (208)	567 (158)	575 (160)	690 (192)	730 (203)
RPM [min ⁻¹]	2700	3100	2760	3150	2770	3160	2800	3210
Sound pressure level at 3 m [dBA]	45	46	48	49	45	47	48	49
Transported air temperature [°C]	-25...+45		-25...+45		-25...+45		-25...+45	
SEC class	C	-	C	-	C	-	C	-
IP rating	IPX4		IPX4		IPX4		IPX4	
Motor IP rating	IP44		IP44		IP44		IP44	
ErP	2018	-	2018	-	2018	-	2018	-

CENTRO-M 150, CENTRO-M 150 MAX

Sound power level, A-weighted	Total	Octave frequency bands [Hz]								LpA 3 m	LpA 1 m
		63	125	250	500	1000	2000	4000	8000		
Centro-M 150											
LWA to inlet [dBA]	90	53	87	86	75	74	71	68	54	69	79
LWA to outlet [dBA]	90	53	88	85	72	71	66	65	52	69	79
LWA to environment [dBA]	66	28	49	58	60	60	60	50	37	45	55
Centro-M 150 max											
LWA to inlet [dBA]	94	56	91	90	79	78	75	71	57	74	84
LWA to outlet [dBA]	94	56	92	89	76	75	69	68	55	74	84
LWA to environment [dBA]	68	29	51	61	63	63	63	52	39	48	58

CENTRO-M 160, CENTRO-M 160 MAX

Sound power level, A-weighted	Total	Octave frequency bands [Hz]								LpA 3 m	LpA 1 m
		63	125	250	500	1000	2000	4000	8000		
Centro-M 160											
LWA to inlet [dBA]	88	52	85	84	74	73	70	67	53	68	78
LWA to outlet [dBA]	87	51	85	82	70	69	64	63	50	67	77
LWA to environment [dBA]	65	28	48	58	58	60	59	51	38	45	55
Centro-M 160 max											
LWA to inlet [dBA]	93	55	90	89	78	77	74	71	56	73	83
LWA to outlet [dBA]	93	55	92	88	75	74	69	68	54	73	83
LWA to environment [dBA]	68	29	51	60	63	63	63	52	38	48	58

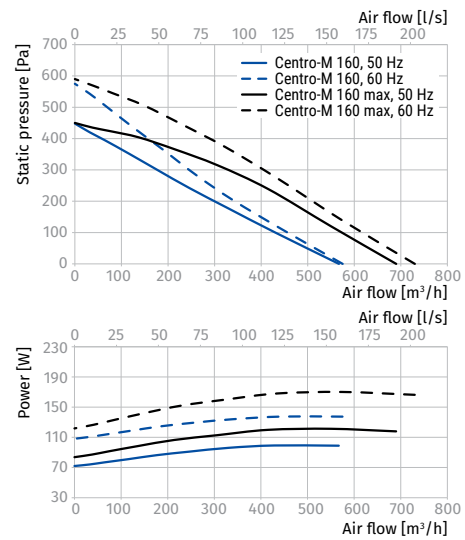
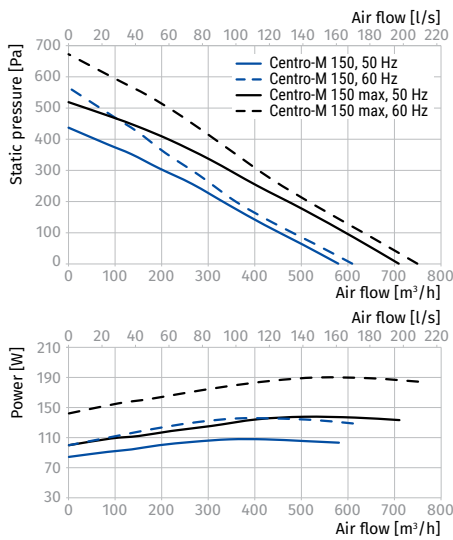

INLINE FANS

Parameters	Centro-M 200		Centro-M 200 max		Centro-M 250 E		Centro-M 250	
Voltage [V]	1 ~ 230		1 ~ 230		1 ~ 230		1 ~ 230	
Frequency [Hz]	50	60	50	60	50	50	60	60
Power [W]	135	182	193	240	95	194	240	
Current [A]	0.59	0.79	0.84	1.05	0.47	0.85	1.05	
Air flow [m ³ /h (l/s)]	1070 (294)	1220 (339)	1150 (319)	1200 (333)	900 (250)	1420 (394)	1520 (422)	
RPM [min ⁻¹]	2710	3120	2780	2850	2050	2790	2860	
Sound pressure level at 3 m [dBA]	48	50	49	49	47	50	51	
Transported air temperature [°C]	-25...+45		-25...+45		-25...+45		-25...+45	
SEC class	C	-	-	-	C	-	-	
IP rating	IPX4		IPX4		IPX4		IPX4	
Motor IP rating	IP44		IP44		IP44		IP44	
ErP	2018	-	2018	-	2018	2018	-	

CENTRO-M 200, CENTRO-M 200 MAX

Sound power level, A-weighted	Total	Octave frequency bands [Hz]								LpA 3 m	LpA 1 m
		63	125	250	500	1000	2000	4000	8000		
Centro-M 200											
LWA to inlet [dBA]	90	49	78	87	81	81	82	74	63	69	79
LWA to outlet [dBA]	87	46	77	81	79	79	82	74	64	67	77
LWA to environment [dBA]	68	29	52	60	63	63	62	53	39	48	58
Centro-M 200 max											
LWA to inlet [dBA]	95	56	92	91	79	78	75	72	57	74	84
LWA to outlet [dBA]	94	56	92	89	75	74	69	68	54	74	84
LWA to environment [dBA]	70	29	52	62	64	64	64	53	39	49	59

CENTRO-M 250 E, CENTRO-M 250

Sound power level, A-weighted	Total	Octave frequency bands [Hz]								LpA 3 m	LpA 1 m
		63	125	250	500	1000	2000	4000	8000		
Centro-M 250 E											
LWA to inlet [dBA]	89	60	76	83	81	83	79	75	64	68	78
LWA to outlet [dBA]	87	63	75	72	80	82	80	75	62	66	76
LWA to environment [dBA]	67	34	48	59	62	62	60	49	38	47	57
Centro-M 250											
LWA to inlet [dBA]	90	61	78	85	83	85	81	77	65	70	80
LWA to outlet [dBA]	88	64	77	73	82	84	82	77	63	68	78
LWA to environment [dBA]	71	38	52	62	66	65	64	58	44	50	60

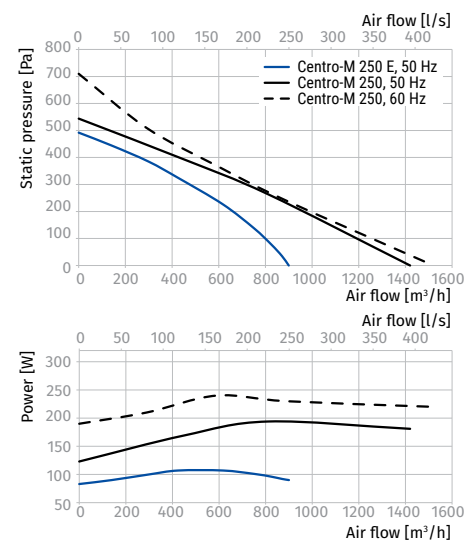
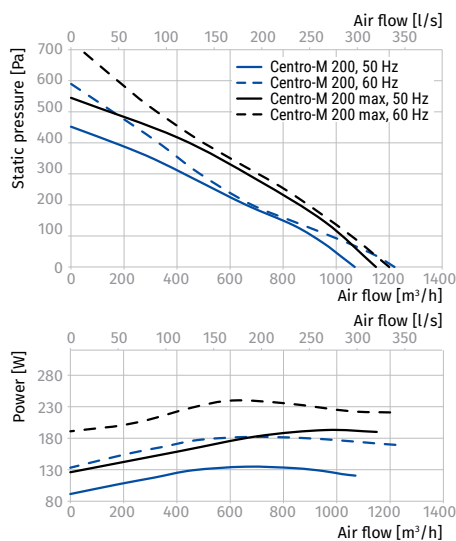

Parameters	Centro-M 315		Centro-M 315 max		Centro-M 355 L	
Voltage [V]	1 ~ 230		1 ~ 230		1 ~ 230	
Frequency [Hz]	50	60	50	60	50	60
Power [W]	171	241	295	413	233	297
Current [A]	0.77	1.05	1.34	1.8	1.06	1.30
Air flow [m³/h (l/s)]	1440 (400)	1550 (431)	1920 (533)	1980 (550)	2250 (625)	2350 (653)
RPM [min⁻¹]	2600	2850	2720	2780	1375	1620
Sound pressure level at 3 m [dBA]	52	53	54	55	58	59
Transported air temperature [°C]	-25...+45		-25...+45		-25...+45	
SEC class	-	-	-	-	-	-
IP rating	IPX4		IPX4		IPX4	
Motor IP rating	IP44		IP44		IP44	
ErP	2018	-	2018	-	2018	-

CENTRO-M 315, CENTRO-M 315 MAX

Sound power level, A-weighted	Total	Octave frequency bands [Hz]								LpA 3 m	LpA 1 m
		63	125	250	500	1000	2000	4000	8000		
Centro-M 315											
LWA to inlet [dBA]	92	62	80	87	85	87	83	79	66	71	81
LWA to outlet [dBA]	91	66	79	75	84	87	84	79	65	70	80
LWA to environment [dBA]	72	37	51	64	67	67	65	53	41	52	62
Centro-M 315 max											
LWA to inlet [dBA]	94	63	81	88	86	88	84	80	68	73	83
LWA to outlet [dBA]	92	67	81	77	86	88	86	81	66	72	82
LWA to environment [dBA]	74	38	53	66	69	69	67	54	42	54	64

CENTRO-M 355 L

Sound power level, A-weighted	Total	Octave frequency bands [Hz]								LpA 3 m	LpA 1 m
		63	125	250	500	1000	2000	4000	8000		
LWA to inlet [dBA]	95	57	82	80	84	90	91	86	75	74	84
LWA to outlet [dBA]	96	61	74	84	81	90	93	85	77	75	85
LWA to environment [dBA]	78	33	55	64	72	74	74	64	56	58	68

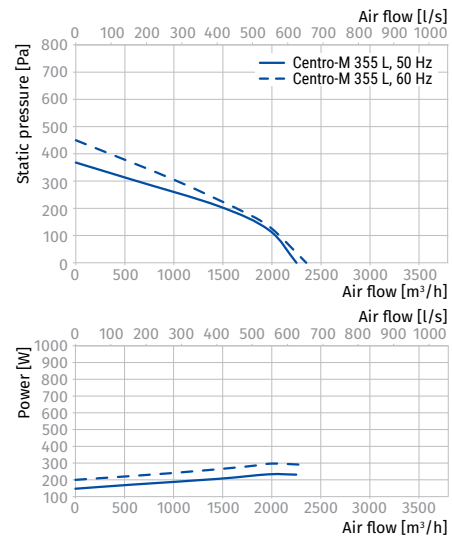
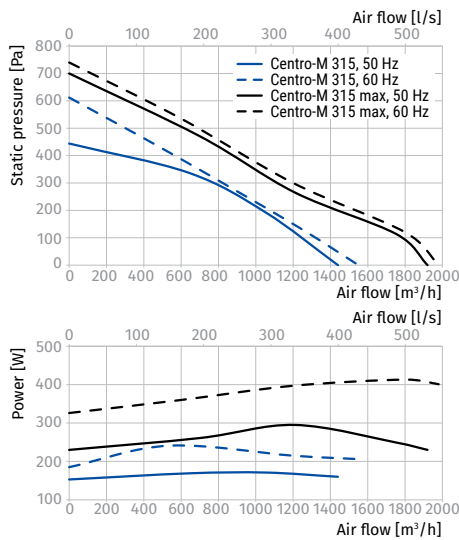

INLINE FANS

Parameters	Centro-M 400		Centro-M 450	
Voltage [V]	1 ~ 230		1 ~ 230	
Frequency [Hz]	50	60	50	60
Power [W]	460	673	665	1250
Current [A]	2.23	3.05	2.89	5.40
Air flow [m³/h (l/s)]	3090 (858)	3500 (972)	5300 (1472)	6280 (1745)
RPM [min⁻¹]	1370	1585	1265	1560
Sound pressure level at 3 m [dBA]	61	64	65	73
Transported air temperature [°C]	-40...+80	-40...+55	-40...+70	-25...+60
SEC class	-	-	-	-
IP rating	IPX4		IPX4	
Motor IP rating	IP44		IP44	
ErP	-	-	2018	-

CENTRO-M 400

Sound power level, A-weighted	Total	Octave frequency bands [Hz]								LpA 3 m	LpA 1 m
		63	125	250	500	1000	2000	4000	8000		
LWA to inlet [dBA]	97	59	84	82	86	92	93	88	78	77	87
LWA to outlet [dBA]	96	61	75	85	82	90	94	86	78	76	86
LWA to environment [dBA]	81	35	57	66	75	77	77	66	58	61	71

CENTRO-M 450

Sound power level, A-weighted	Total	Octave frequency bands [Hz]								LpA 3 m	LpA 1 m
		63	125	250	500	1000	2000	4000	8000		
LWA to inlet [dBA]	98	59	85	83	87	93	94	89	78	78	88
LWA to outlet [dBA]	98	63	76	87	84	92	95	88	80	78	88
LWA to environment [dBA]	86	37	60	70	79	81	81	70	61	65	75

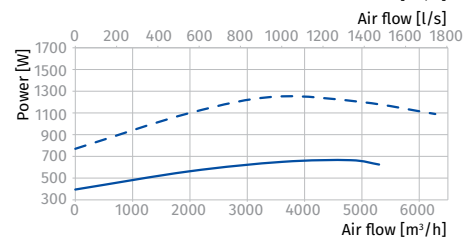
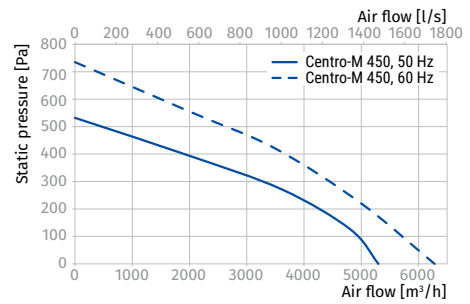
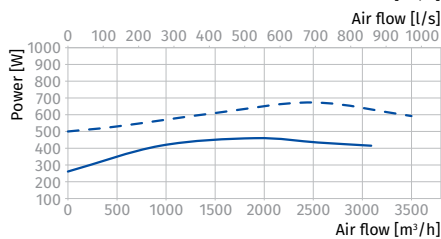
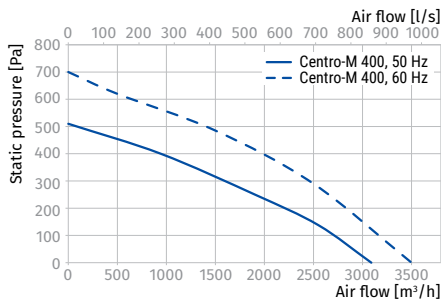

INLINE FANS

Centro-M EC

Inline centrifugal fans with EC motor

Use

- Supply and extract ventilation systems installed in various premises.
- Direct mounting inside air ductworks.
- For arranging energy-saving and controllable ventilation systems.
- Compatible with Ø 100 to 315 mm round air ducts.



Air flow:
up to 1370 m³/h
381 l/s



Power:
from 83 W



Noise level:
from 44 dBA



Design

- The casing is made of steel with a special polymer coating.
- Aerodynamically shaped casing.
- External terminal box for connection to power mains.

Motor

- High-efficient direct current EC motor with external rotor and backward curved blades.
- EC technology meets the up-to-date requirements to energy-saving and controllable ventilation and provides up to 35 % energy saving as compared to asynchronous motors.
- EC motor ensures totally controllable speed range for the fan and has integrated overheating protection with automatic restart.
- EC motor has no friction and wearing parts as capacitor and brushes. Instead a maintenance-free EC controller electronic circuit board is used.
- The impeller is dynamically balanced.
- The fan is compatible with 50 Hz and 60 Hz power mains and the maximum speed does not depend on power mains frequency.

Operation and speed control

- The fan speed is controlled with a 0–10 V control signal from the following sources:
 - integrated or external speed controller
 - controller with sensors
 - central BMS system.
- The control signal value changes depending on air temperature, pressure, smoke concentration and other parameters.
- During signal value change the fan with EC motor correspondingly changes the rotations speed and delivers required air volume to the ventilation system.
- The computer central building management systems (BMS) enable integration of several EC motors in network and precise individual operation control for each fan.

Mounting

- Any mounting position.
- Fans are fixed to wall or ceiling with mounting brackets supplied as a standard.
- Flexible air ducts are fixed on the fan spigots with clamps.

Designation key

Series	Motor type	Duct diameter [mm]	Options
Centro-M	EC: electronically commutated motor	100; 125; 150; 160; 200; 250; 315	max: high-powered motor FR1: smooth speed controller adjustable from 0 to 100 % and power cable with mains plug G1: speed controller, temperature controller with external temperature sensor, power cable with mains plug W1: power cable with mains plug

Accessories

Silencers	Filter boxes	Electric heaters	Water heaters	Backdraft air dampers	Air dampers	Clamps	Speed controllers
 SD	 KFBK / KFBT	 EKH	 WKH	 VRV	 VK / VKA	 KZ	 CDT E1.8

Overall dimensions [mm]

Type	Ø D	Ø D1	B	B1	L	L1	L2	L3	Weight [kg]
Centro-M EC 100	98	255	310	270	203	20	25	30	3.45
Centro-M EC 125	123	255	310	270	203	20	25	30	3.58
Centro-M EC 150	149	305	360	320	240	25	25	30	4.70
Centro-M EC 160	159	305	360	320	240	25	25	30	4.90
Centro-M EC 200	198	345	395	355	245	25	30	40	5.70
Centro-M EC 200 max	198	345	395	355	255	25	30	40	5.70
Centro-M EC 250	248	345	395	355	250	25	30	40	5.09
Centro-M EC 315	314	405	455	415	260	30	30	40	7.30

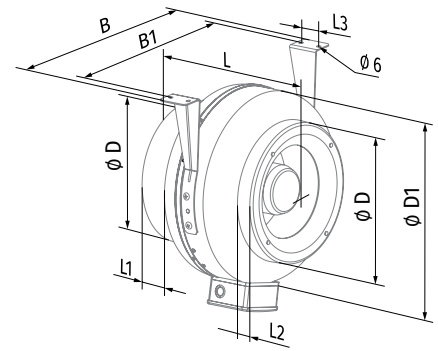

Technical data

Parameters	Centro-M EC 100	Centro-M EC 125
Voltage [V]	1 ~ 230	1 ~ 230
Frequency [Hz]	50/60	50/60
Power [W]	90	83
Current [A]	0.70	0.58
Maximum air flow [m³/h (l/s)]	345 (96)	480 (133)
RPM [min⁻¹]	3600	3400
Sound pressure at 3 m [dBA]	44	45
Transported air temperature [°C]	-25...+60	-25...+60
SEC class	B	B
IP rating	IPX4	IPX4
ErP compliance	2018	2018

CENTRO-M EC 100

Sound power level, A-weighted	Total	Octave frequency bands [Hz]								LpA 3 m	LpA 1 m
		63	125	250	500	1000	2000	4000	8000		
L _{WA} to inlet [dBA]	90	66	82	89	80	74	70	63	51	70	80
L _{WA} to outlet [dBA]	89	73	82	88	79	70	66	61	49	69	79
L _{WA} to environment [dBA]	65	31	47	56	60	59	58	47	33	44	54

CENTRO-M EC 125

Sound power level, A-weighted	Total	Octave frequency bands [Hz]								LpA 3 m	LpA 1 m
		63	125	250	500	1000	2000	4000	8000		
L _{WA} to inlet [dBA]	91	62	83	90	79	74	71	65	54	71	81
L _{WA} to outlet [dBA]	90	69	83	89	78	71	68	63	52	70	80
L _{WA} to environment [dBA]	65	27	48	58	59	60	60	49	37	45	55

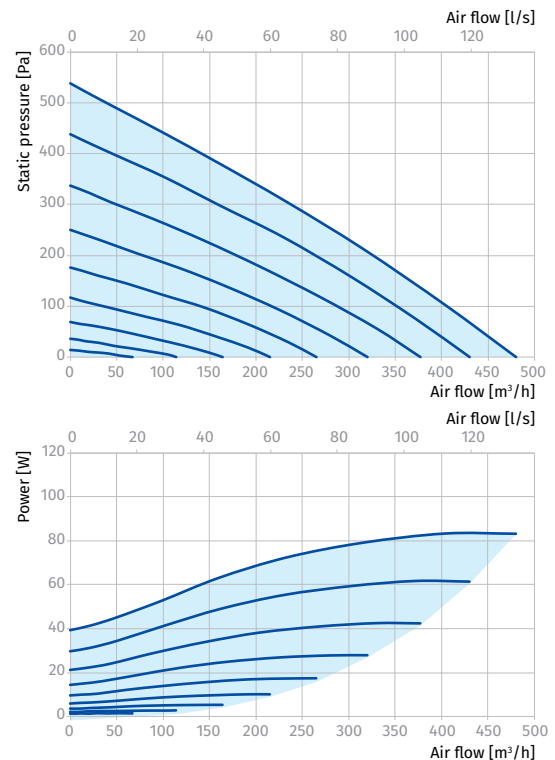
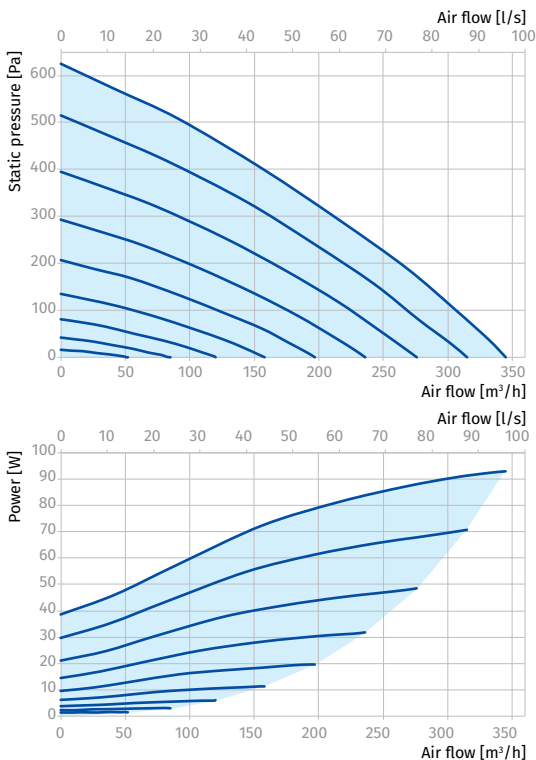

Parameters	Centro-M EC 150	Centro-M EC 160
Voltage [V]	1 ~ 230	1 ~ 230
Frequency [Hz]	50/60	50/60
Power [W]	107	108
Current [A]	0.89	0.90
Maximum air flow [m ³ /h (l/s)]	700 (194)	785 (218)
RPM [min ⁻¹]	3060	3030
Sound pressure at 3 m [dBA]	48	48
Transported air temperature [°C]	-25...+60	-25...+60
SEC class	B	B
IP rating	IPX4	IPX4
ErP compliance	2018	2018

CENTRO-M EC 150

Sound power level, A-weighted	Total	Octave frequency bands [Hz]								LpA 3 m	LpA 1 m
		63	125	250	500	1000	2000	4000	8000		
L _{WA} to inlet [dBA]	89	52	86	85	74	72	70	67	54	68	78
L _{WA} to outlet [dBA]	87	51	85	82	70	68	64	63	51	66	76
L _{WA} to environment [dBA]	69	28	50	61	64	63	62	54	41	48	58

CENTRO-M EC 160

Sound power level, A-weighted	Total	Octave frequency bands [Hz]								LpA 3 m	LpA 1 m
		63	125	250	500	1000	2000	4000	8000		
L _{WA} to inlet [dBA]	89	81	87	79	72	68	62	50	54	68	78
L _{WA} to outlet [dBA]	88	81	86	78	69	65	60	48	51	67	77
L _{WA} to environment [dBA]	69	50	59	64	63	61	50	36	41	48	58

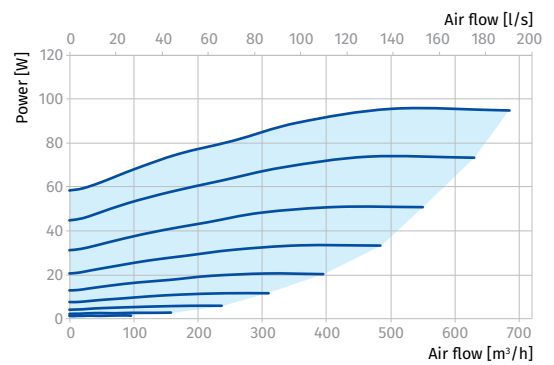
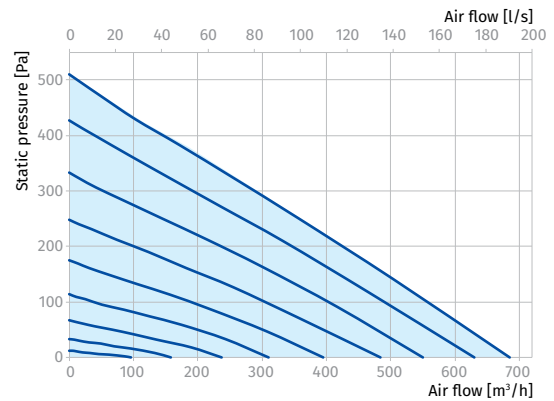
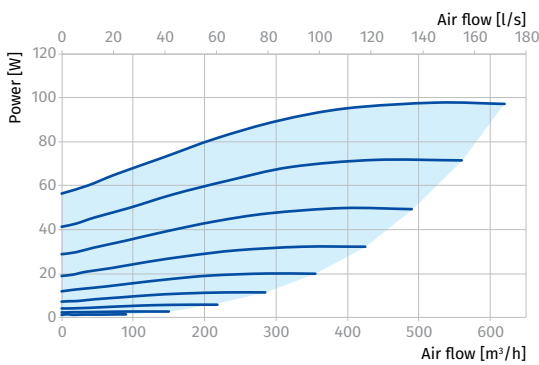
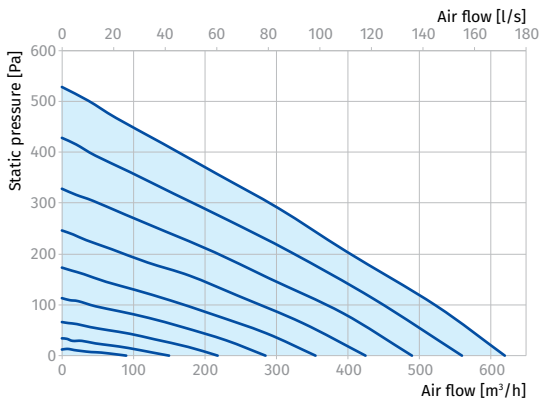

Parameters	Centro-M EC 200	Centro-M EC 200 max
Voltage [V]	1 ~ 230	1 ~ 230
Frequency [Hz]	50/60	50/60
Power [W]	83	100
Current [A]	0.63	0.74
Maximum air flow [m³/h (l/s)]	845 (235)	1010 (281)
RPM [min ⁻¹]	2500	2400
Sound pressure at 3 m [dBA]	47	48
Transported air temperature [°C]	-25...+60	-25...+60
SEC class	B	B
IP rating	IPX4	IPX4
ErP compliance	2018	2018

CENTRO-M EC 200

Sound power level, A-weighted	Total	Octave frequency bands [Hz]								LpA 3 m	LpA 1 m
		63	125	250	500	1000	2000	4000	8000		
LWA to inlet [dBA]	87	48	76	84	79	79	80	72	61	67	77
LWA to outlet [dBA]	85	45	75	79	77	77	80	72	62	64	74
LWA to environment [dBA]	67	27	49	60	62	61	60	52	39	47	57

CENTRO-M EC 200 MAX

Sound power level, A-weighted	Total	Octave frequency bands [Hz]								LpA 3 m	LpA 1 m
		63	125	250	500	1000	2000	4000	8000		
LWA to inlet [dBA]	93	63	80	88	85	87	84	79	67	72	82
LWA to outlet [dBA]	89	65	77	74	83	84	83	77	64	68	78
LWA to environment [dBA]	68	30	49	58	62	65	61	52	38	48	58

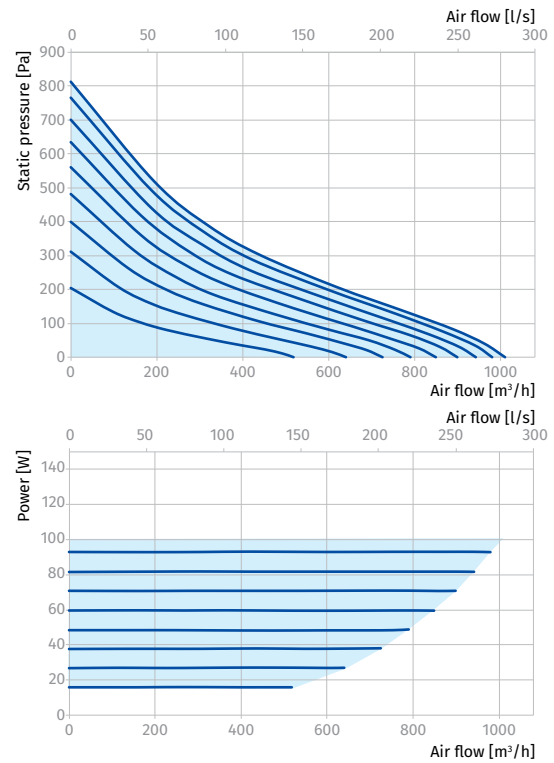
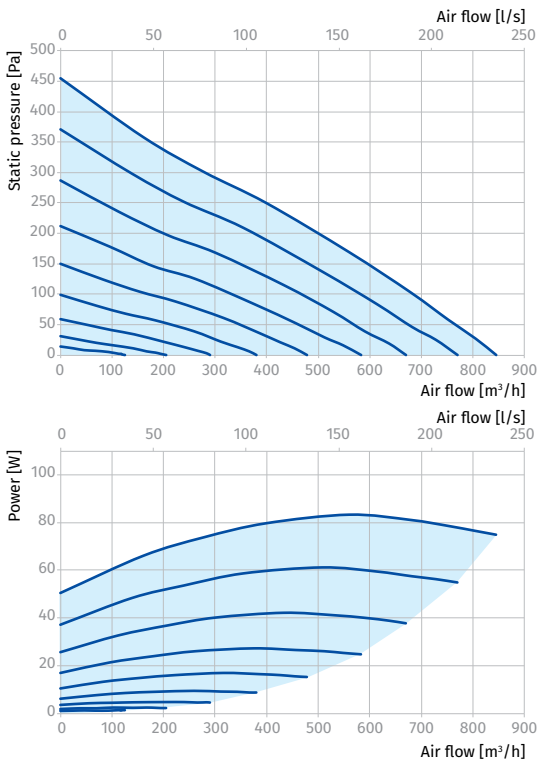

INLINE FANS

Parameters	Centro-M EC 250	Centro-M EC 315
Voltage [V]	1 ~ 230	1 ~ 230
Frequency [Hz]	50/60	50/60
Power [W]	164	164
Current [A]	1.15	1.15
Maximum air flow [m³/h (l/s)]	1230 (342)	1370 (381)
RPM [min ⁻¹]	2900	2900
Sound pressure at 3 m [dBA]	46	48
Transported air temperature [°C]	-25...+60	-25...+60
SEC class	-	-
IP rating	IPX4	IPX4
ErP compliance	2018	2018

CENTRO-M EC 250

Sound power level, A-weighted	Total	Octave frequency bands [Hz]								LpA 3 m	LpA 1 m
		63	125	250	500	1000	2000	4000	8000		
L _{WA} to inlet [dBA]	90	61	77	85	83	84	81	76	65	69	79
L _{WA} to outlet [dBA]	89	65	77	74	83	85	83	78	64	69	79
L _{WA} to environment [dBA]	67	29	48	57	60	63	59	51	37	46	56

CENTRO-M EC 315

Sound power level, A-weighted	Total	Octave frequency bands [Hz]								LpA 3 m	LpA 1 m
		63	125	250	500	1000	2000	4000	8000		
L _{WA} to inlet [dBA]	86	51	73	71	75	81	82	77	68	66	76
L _{WA} to outlet [dBA]	87	55	66	76	73	81	84	77	69	67	77
L _{WA} to environment [dBA]	69	30	48	56	62	64	64	56	49	48	58

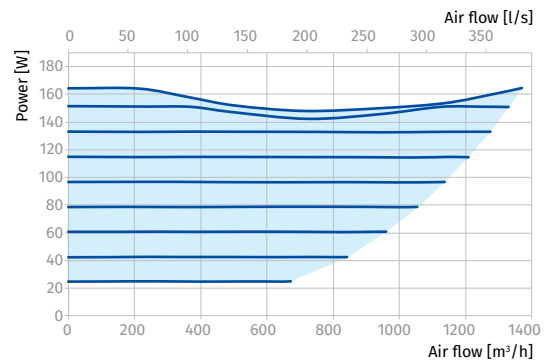
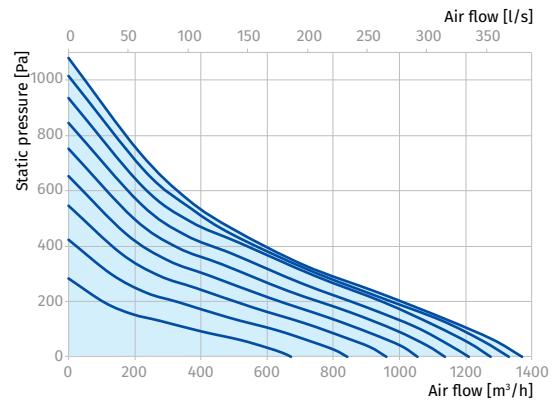
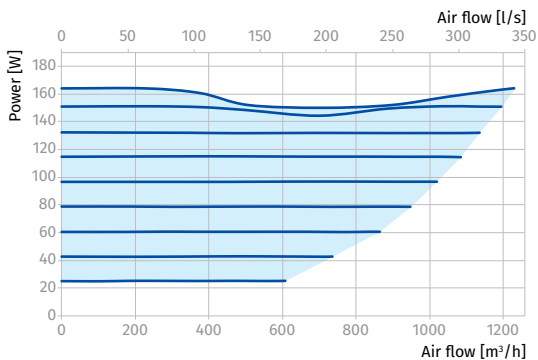
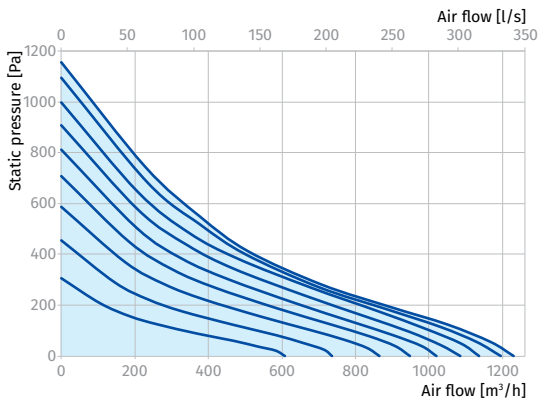

INLINE FANS

Centro-MZ

Inline centrifugal fans

Use

- Supply and extract ventilation systems installed in various premises.
- The best solution both for humid indoor premises and outside areas.
- Compatible with Ø 100 up to 315 mm round air ducts.



Air flow:
up to 1540 m³/h
428 l/s



Power:
from 60 W



Noise level:
from 35 dBA



Design

- Galvanized steel casing.
- Aerodynamically shaped casing.
- External terminal block for power supply.

Motor

- Single-phase external rotor motor with a centrifugal impeller with backward curved blades.
- Equipped with ball bearings for longer service life.
- Integrated thermal protection with automatic restart.
- Dynamically balanced impeller.
- For ventilation of premises with high requirements to noise level low-noise modifications are available (**Centro-MZ L**).

Speed control

- Smooth speed control with an external thyristor controller or step speed control with an external auto transformer (both available upon separate order).

Mounting

- Any mounting position.
- Wall or ceiling mounting with fixing brackets supplied as a standard.
- Flexible air ducts are fixed on the fan spigots with clamps.

Modifications and options

- max:** high-powered motor.
- L:** low-powered and low-noise motor.
- W1:** power cable with mains plug.

Designation key

Series	Duct diameter [mm]	Motor modifications	Options
Centro-MZ	100; 125; 150; 160; 200; 250; 315	max: high-powered motor L: low-powered motor	W1: power cable with mains plug

Overall dimensions [mm]

Type	Ø D	Ø D1	B	B1	L	L1	L2	L3	Weight [kg]
Centro-MZ 100 (L)	98	237	253	293	202	23	22	30	3.16
Centro-MZ 125 (L)	123	237	253	293	202	23	22	30	3.16
Centro-MZ 150	149	274	290	330	170	20	20	30	3.5
Centro-MZ 150 max	149	345	355	395	230	20	20	40	5.6
Centro-MZ 160	158	278	294	334	200	25	23	30	3.44
Centro-MZ 200 (L)	198	332	340	380	245	25	29	40	5.43
Centro-MZ 250 (L)	249	332	340	380	213	25	29	40	5.25
Centro-MZ 315 (L)	313	402	410	450	308	33	55	40	6.57

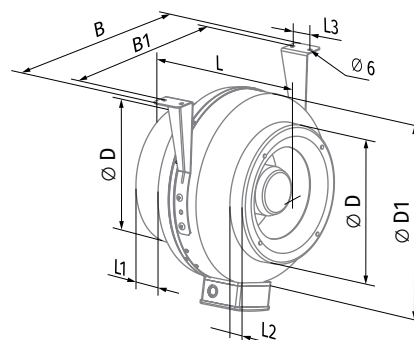

Accessories

Silencers	Filter boxes	Electric heaters	Water heaters	Backdraft air dampers	Air dampers	Clamps	Speed controllers
							
SD	KFBK / KFBT	EKH	WKH	VRV	VK / VKA	KZ	CDT E1.8

Technical data

Parameters	Centro-MZ 100 L		Centro-MZ 100		Centro-MZ 125 L		Centro-MZ 125	
Voltage [V]	1 ~ 230		1 ~ 230		1 ~ 230		1 ~ 230	
Frequency [Hz]	50	60	50	60	50	60	50	60
Power [W]	60	61	72	77	60	61	78	79
Current [A]	0.37	0.37	0.32	0.33	0.37	0.37	0.34	0.34
Maximum air flow [m³/h (l/s)]	195 (54)	204 (57)	250 (69)	285 (79)	230 (64)	240 (67)	330 (92)	340 (94)
RPM [min⁻¹]	2670	2710	2820	2880	2605	2720	2820	2880
Sound pressure at 3 m [dBA]	35	36	46	47	35	36	46	46
Transported air temperature [°C]	-25...+55	-25...+50	-25...+55	-25...+50	-25...+55	-25...+50	-25...+55	-25...+50
SEC class	C		C		C		C	
IP rating	IPX4		IPX4		IPX4		IPX4	
Motor IP rating	IP44		IP44		IP44		IP44	
ErP	2018		2018		2018		2018	

CENTRO-MZ 100 L, CENTRO-MZ 100

Sound power level, A-weighted	Total	Octave frequency bands [Hz]							
		63	125	250	500	1000	2000	4000	8000
Centro-MZ 100 L									
LWA to inlet [dBA]	63	51	57	56	57	51	46	40	29
LWA to outlet [dBA]	65	54	62	58	61	57	50	45	33
LWA to environment [dBA]	55	19	14	21	34	42	41	29	17
Centro-MZ 100									
LWA to inlet [dBA]	72	47	67	68	67	60	54	53	42
LWA to outlet [dBA]	73	56	67	72	66	63	58	57	42
LWA to environment [dBA]	64	43	60	57	41	24	6	17	24

CENTRO-MZ 125 L, CENTRO-MZ 125

Sound power level, A-weighted	Total	Octave frequency bands [Hz]							
		63	125	250	500	1000	2000	4000	8000
Centro-MZ 125 L									
LWA to inlet [dBA]	59	31	52	54	53	49	46	35	30
LWA to outlet [dBA]	61	35	53	56	60	51	49	35	34
LWA to environment [dBA]	64	46	60	59	43	33	15	30	28
Centro-MZ 125									
LWA to inlet [dBA]	75	56	63	68	69	64	61	52	41
LWA to outlet [dBA]	75	58	71	74	72	65	65	56	47
LWA to environment [dBA]	64	52	64	59	48	36	23	30	27

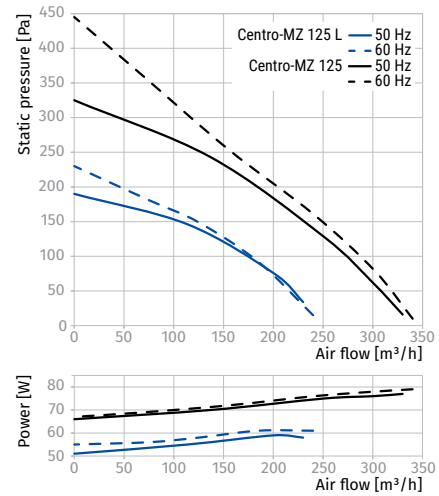
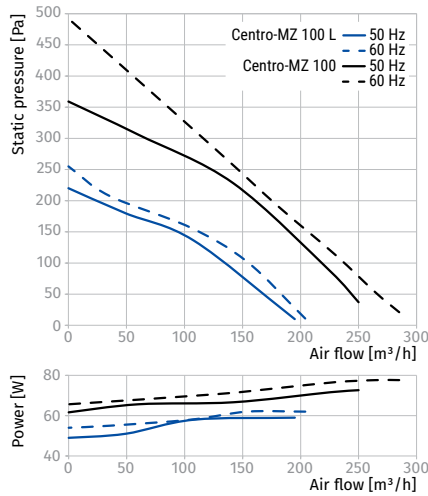

Parameters	Centro-MZ 150		Centro-MZ 150 max		Centro-MZ 160		Centro-MZ 200 L		Centro-MZ 200	
Voltage [V]	1 ~ 230		1 ~ 230		1 ~ 230		1 ~ 230		1 ~ 230	
Frequency [Hz]	50	60	50	60	50	60	50	60	50	60
Power [W]	64	78	127	174	78	81	139	177	157	202
Current [A]	0.29	0.34	0.56	0.77	0.34	0.35	0.61	0.78	0.69	0.88
Maximum air flow [m³/h (l/s)]	455 (125)	475 (132)	710 (197)	750 (208)	455 (126)	460 (128)	840 (233)	940 (261)	1000 (278)	1045 (290)
RPM [min ⁻¹]	2780	3216	2760	3144	2760	2820	2790	2850	2740	2840
Sound pressure at 3 m [dBA]	44	45	48	49	46	46	48	49	50	50
Transported air temperature [°C]	-25...+50		-25...+60		-25...+55		-25...+50		-25...+45	
SEC class	B		B		B		B		B	
IP rating	IPX4		IPX4		IPX4		IPX4		IPX4	
Motor IP rating	IP44		IP44		IP44		IP44		IP44	
ErP	2018		2018		2018		2018		2018	

CENTRO-MZ 150, CENTRO-MZ 150 MAX

Sound power level, A-weighted	Total	Octave frequency bands [Hz]							
		63	125	250	500	1000	2000	4000	8000
Centro-MZ 150									
LWA to inlet [dBA]	90	53	87	86	75	74	71	68	54
LWA to outlet [dBA]	90	53	88	85	72	71	66	65	52
LWA to environment [dBA]	66	28	49	58	60	60	60	50	37
Centro-MZ 150 max									
LWA to inlet [dBA]	94	56	91	90	79	78	75	71	57
LWA to outlet [dBA]	94	56	92	89	76	75	69	68	55
LWA to environment [dBA]	68	29	51	61	63	63	63	52	39

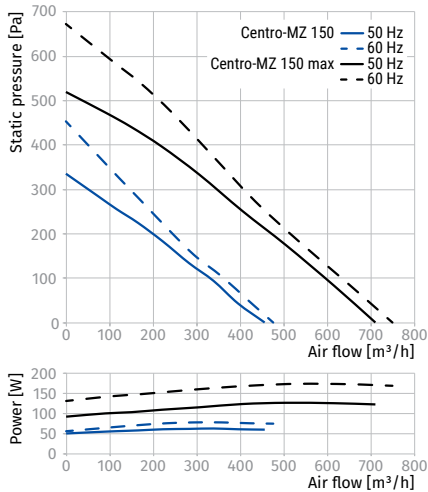

CENTRO-MZ 160

Sound power level, A-weighted	Total	Octave frequency bands [Hz]							
		63	125	250	500	1000	2000	4000	8000
LWA to inlet [dBA]	69	42	67	66	63	61	58	48	35
LWA to outlet [dBA]	72	46	69	65	68	64	63	50	40
LWA to environment [dBA]	60	41	60	53	36	20	18	30	24

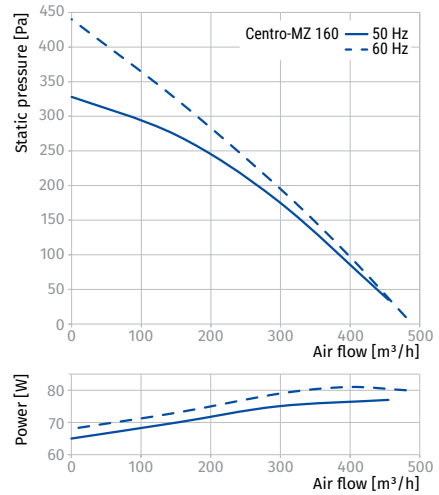

CENTRO-MZ 200 L, CENTRO-MZ 200

Sound power level, A-weighted	Total	Octave frequency bands [Hz]							
		63	125	250	500	1000	2000	4000	8000
Centro-MZ 200 L									
LWA to inlet [dBA]	76	47	68	65	70	67	59	58	50
LWA to outlet [dBA]	76	49	71	69	72	63	63	60	53
LWA to environment [dBA]	64	46	61	57	48	32	27	48	42
Centro-MZ 200									
LWA to inlet [dBA]	73	51	66	68	71	67	64	58	52
LWA to outlet [dBA]	79	51	73	69	74	67	65	60	50
LWA to environment [dBA]	68	47	64	64	46	32	30	44	42

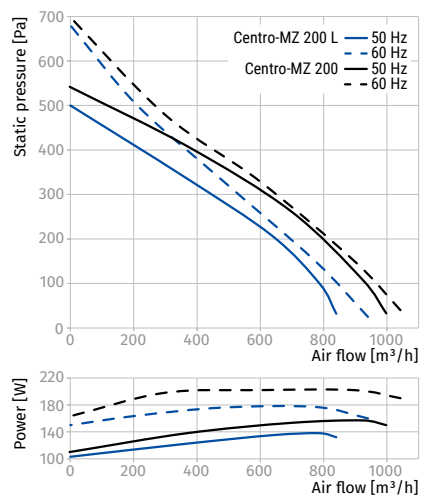

Parameters	Centro-MZ 250 L		Centro-MZ 250		Centro-MZ 315 L		Centro-MZ 315	
Voltage [V]	1 ~ 230		1 ~ 230		1 ~ 230		1 ~ 230	
Frequency [Hz]	50	60	50	60	50	60	50	60
Power [W]	134	175	152	202	151	205	185	238
Current [A]	0.59	0.77	0.66	0.88	0.66	0.89	0.81	1.04
Maximum air flow [m³/h (l/s)]	980 (272)	1030 (286)	1070 (297)	1100 (306)	1330 (369)	1370 (381)	1540 (428)	1580 (439)
RPM [min⁻¹]	2785	2880	2765	2560	2680	2750	2730	2870
Sound pressure at 3 m [dBA]	51	51	52	52	52	52	53	54
Transported air temperature [°C]	-25...+50	-25...+50	-25...+50	-25...+50	-25...+50	-25...+50	-25...+45	-25...+45
SEC class	B		B		-		-	
IP rating	IPX4		IPX4		IPX4		IPX4	
Motor IP rating	IP44		IP44		IP44		IP44	
ErP	2018		2018		2018		2018	

CENTRO-MZ 250 L, CENTRO-MZ 250

Sound power level, A-weighted	Total	Octave frequency bands [Hz]							
		63	125	250	500	1000	2000	4000	8000
Centro-MZ 250 L									
LWA to inlet [dBA]	69	46	59	61	65	62	58	60	54
LWA to outlet [dBA]	74	49	59	63	66	67	62	64	56
LWA to environment [dBA]	60	42	54	54	44	37	37	52	45
Centro-MZ 250									
LWA to inlet [dBA]	75	60	66	67	67	67	63	56	45
LWA to outlet [dBA]	76	60	73	71	69	65	66	59	46
LWA to environment [dBA]	65	58	62	60	47	43	40	47	36

CENTRO-MZ 315 L, CENTRO-MZ 315

Sound power level, A-weighted	Total	Octave frequency bands [Hz]							
		63	125	250	500	1000	2000	4000	8000
Centro-MZ 315 L									
LWA to inlet [dBA]	70	35	53	61	65	67	61	58	56
LWA to outlet [dBA]	74	41	54	64	73	70	65	62	60
LWA to environment [dBA]	59	35	49	53	50	46	51	50	50
Centro-MZ 315									
LWA to inlet [dBA]	77	53	66	71	69	68	66	63	60
LWA to outlet [dBA]	78	58	71	74	72	71	71	63	63
LWA to environment [dBA]	70	55	66	61	57	48	54	56	51

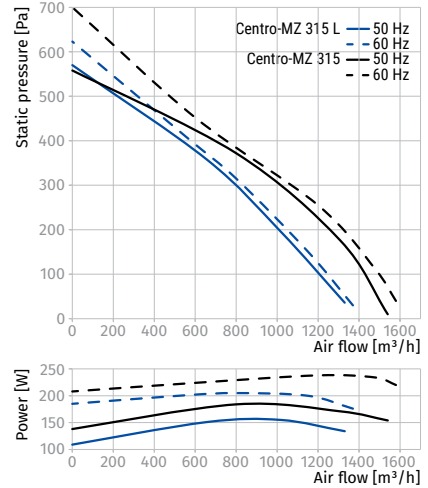
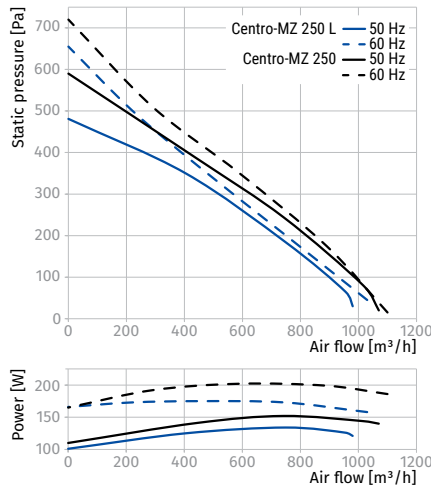

Box

Inline centrifugal fans

Use

- Supply and extract ventilation systems installed in small premises.
- Mounting in limited space.
- Compatible with \varnothing 100 up to 160 mm round air ducts.



Air flow:
up to 553 m³/h
154 l/s



Power:
from 58 W



Noise level:
from 47 dBA



Design

- Compact steel casing covered with special polymer coating.
- Casing height from 110 up to 175 mm depending on the modification.
- Aerodynamically shaped casing.
- External terminal block for power supply.
- A hinged cover plate provides easy access to the motor with no need to dismantle the fans and air ducts.
- The connection spigots are equipped with rubber seals.

Motor

- Single-phase external rotor motor with a centrifugal impeller and backward curved blades.
- Equipped with ball bearings for longer service life.
- Integrated thermal protection with automatic restart.
- Dynamically balanced impeller.

Speed control

- Smooth speed control with an external thyristor controller or step speed control with an external auto transformer (both available upon separate order).

Mounting

- Due to compact design the fan is the ideal solution for mounting in limited spaces, including the space behind false ceiling.
- Any mounting position.
- Wall or ceiling mounting with a fixing bracket supplied as a standard.
- Flexible air ducts are fixed on the fan spigots with clamps.

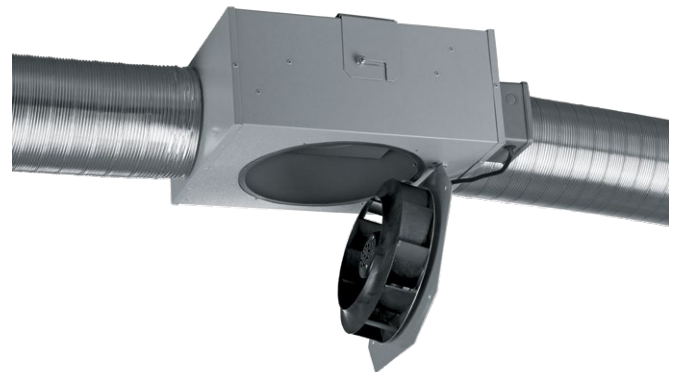

INLINE FANS

Designation key

Series	Spigot diameter [mm]
Box	100; 125; 150; 160

Overall dimensions [mm]

Type	\varnothing D	B	H	L	L2	Weight [kg]
Box 100	99	252	133	420	321	4.65
Box 125	124	252	133	420	321	4.55
Box 150	149	300	170	480	382	6.35
Box 160	159	300	170	480	382	6.6

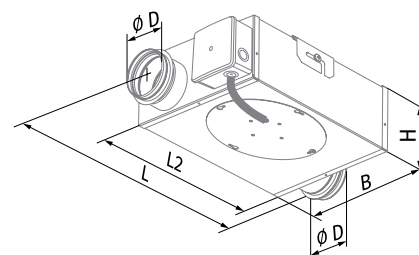

Accessories

Silencers	Filter boxes	Electric heaters	Water heaters	Backdraft air dampers	Air dampers	Clamps	Speed controllers
SD	KFBK / KFBT	EKH	WKH	VRV	VK / VKA	KZ	CDT E1.8

Technical data

Parameters	Box 100	Box 125	Box 150	Box 160
Voltage [V]	1 ~ 230	1 ~ 230	1 ~ 230	1 ~ 230
Frequency [Hz]	50/60	50/60	50/60	50/60
Power [W]	58	58	85	85
Current [A]	0.26	0.26	0.38	0.38
Maximum air flow [m³/h (l/s)]	240 (67)	340 (94)	553 (154)	553 (154)
RPM [min⁻¹]	2500	2500	2600	2600
Sound pressure at 3 m [dBA]	47	48	50	50
Transported air temperature [°C]	-25...+50	-25...+50	-25...+40	-25...+40
SEC class	C	B	B	B
IP rating	IPX4	IPX4	IPX4	IPX4
Motor IP rating	IP44	IP44	IP44	IP44
ErP	2018	2018	2018	2018

BOX 100

Sound power level, A-weighted	Total	Octave frequency bands [Hz]							
		63	125	250	500	1000	2000	4000	8000
LWA to inlet [dBA]	58	53	55	53	51	51	54	53	48
LWA to outlet [dBA]	66	51	51	54	56	64	61	56	52
LWA to environment [dBA]	51	38	37	42	43	46	41	40	32

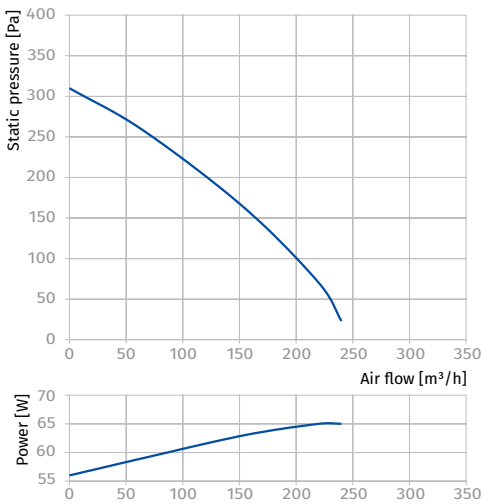

BOX 125

Sound power level, A-weighted	Total	Octave frequency bands [Hz]							
		63	125	250	500	1000	2000	4000	8000
LWA to inlet [dBA]	63	53	51	56	56	53	54	51	49
LWA to outlet [dBA]	65	49	49	59	57	62	61	56	53
LWA to environment [dBA]	48	38	40	42	41	43	42	37	33

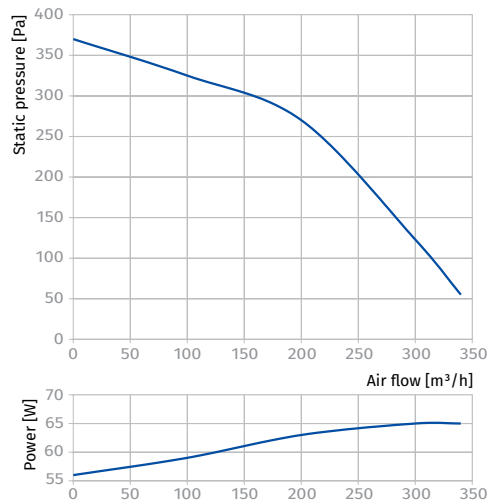

BOX 150

Sound power level, A-weighted	Total	Octave frequency bands [Hz]							
		63	125	250	500	1000	2000	4000	8000
LWA to inlet [dBA]	62	51	51	58	56	54	54	52	51
LWA to outlet [dBA]	66	45	46	60	56	61	61	55	54
LWA to environment [dBA]	49	36	38	44	44	42	41	38	35

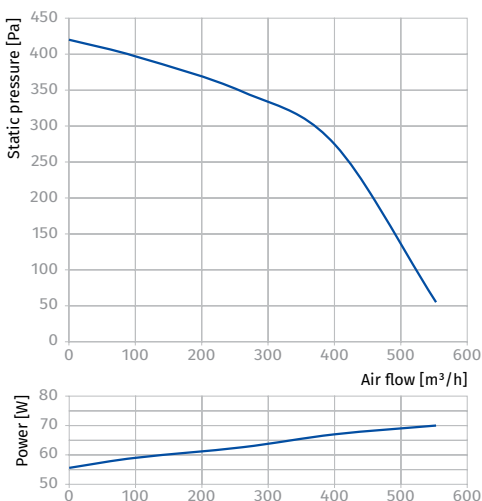

BOX 160

Sound power level, A-weighted	Total	Octave frequency bands [Hz]							
		63	125	250	500	1000	2000	4000	8000
LWA to inlet [dBA]	64	52	51	59	57	54	55	54	50
LWA to outlet [dBA]	69	47	46	58	59	65	61	57	55
LWA to environment [dBA]	52	40	37	42	43	44	43	36	33

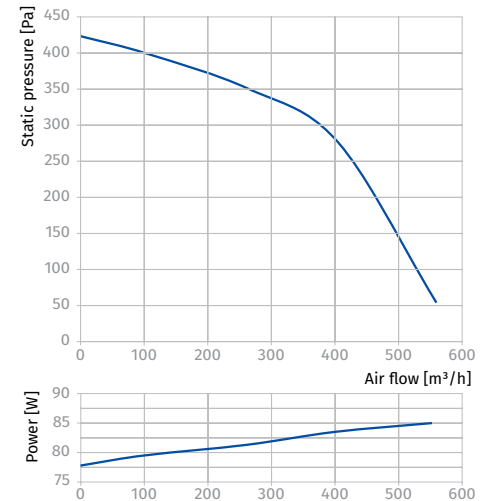

INLINE FANS

Box-R

Inline centrifugal fans

Use

- Supply and extract ventilation systems installed in small premises.
- High-pressure inline fan for ventilation systems installed in multi-level buildings and premises.
- Mounting in limited space.
- For multiport extract ventilation from several premises.
- Compatible with Ø 80 up to 200 mm round air ducts.



Air flow:
up to 783 m³/h
218 l/s



Power:
from 20 W



Noise level:
from 32 dBA



Design

- Steel supercompact casing covered with special polymer coating.
- Minimum casing height is only 90 mm.
- Aerodynamically shaped casing.
- External terminal block for power supply.
- Swivel cover provides easy access to the motor.
- Various casing modifications include from 1 to 6 inlet spigots.
- The connection spigots are equipped with rubber seals.

Motor

- Single-phase electric motor (1, 2, or 3 speeds) with an external rotor and a centrifugal impeller with forward-curved blades made from galvanised steel
- Equipped with ball bearings for longer service life.
- Integrated thermal protection with automatic restart.
- Dynamically balanced impeller.

Speed control

- In single-speed models stepped speed control is provided by means of an external thyristor or autotransformer controller (sold separately).
- The **V2** models are regulated by an external **CDP-2/5** or **CDP-2/10** switch (sold separately).
- The **V3** models are regulated by an external **CDP-3/5** switch (sold separately).

Mounting

- Due to compact design the fan is the ideal solution for mounting in limited spaces, including the space behind false ceiling.
- Any mounting position.
- Wall or ceiling mounting with a fixing bracket supplied as a standard.
- Flexible air ducts are fixed on the fan spigots with clamps.

Modifications

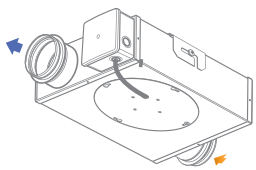

1 inlet pipe
Ø 80 or 100 mm

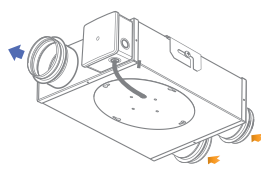

2 inlet pipes
Ø 80 or 100 mm

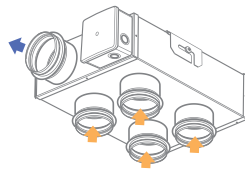

4 inlet pipes
Ø 80 or 100 mm

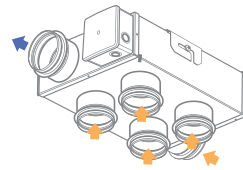

5 inlet pipes
Ø 80 or 100 mm

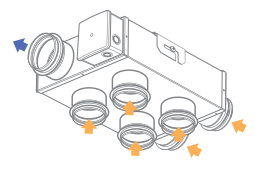

6 inlet pipes
Ø 80 or 100 mm

Designation key

Series	Outlet spigot diameter [mm]	Inlet spigot diameter [mm]	Number of inlet spigots	Motor modifications
Box-R	80; 100; 125; 150; 200	/ 80; 100; 125; 150; 200	x _: (1 by default); 2; 4; 5; 6	_: single-speed motor V2 : two-speed motor V3 : three-speed motor max : high-powered motor

Accessories

Backdraft air dampers	Air dampers	Clamps	Temperature controllers	Speed controllers	Timers/Sensors
VRV	VK / VKA	K	MLCD E2	CDP	TE(TI) / HSE(HSI) / LSE(LSI) / IRSE(IRSI)

Overall dimensions [mm]

Type	∅ D	∅ D1	B	H	H1	L	L1	L2	Weight [kg]
Box-R 80 V3	79	79	260	90	-	352	-	253	3.2
Box-R 80/80x2 V3	79	2x79	260	90	-	352	-	253	3.1
Box-R 80/80x4 V3	79	2x79	260	90	150	-	302	253	3.4
Box-R 80/80x5 V3	79	5x79	260	90	150	352	-	253	3.5
Box-R 80/80x6 V3	79	6x79	260	90	150	352	-	253	3.6
Box-R 100 V3	99	99	260	110	-	352	-	253	3.2
Box-R 100/80x2 V3	99	2x79	260	110	-	352	-	253	3.1
Box-R 100/80x4 V3	99	4x79	260	110	170	-	302	253	3.1
Box-R 100/80x5 V3	99	5x79	260	110	170	352	-	253	3.7
Box-R 100/80x6 V3	99	6x79	260	110	150	352	-	253	3.6
Box-R 100/100x2 V3	99	2x99	260	110	-	352	-	253	3.1
Box-R 100/100x4 V3	99	4x99	260	110	170	-	302	253	3.4
Box-R 100/100x5 V3	99	5x99	260	110	170	352	-	253	3.5
Box-R 100/100x6 V3	99	6x99	260	110	170	352	-	253	3.5
Box-R 125	124	124	270	141	-	397	-	299	5.2
Box-R 125 max	124	124	270	141	-	397	-	299	5.8
Box-R 125 V2	124	124	303	152	-	430	-	330	6.0
Box-R 150	149	149	340	207	-	447	-	350	7.1
Box-R 150 V2	149	149	340	207	-	447	-	350	7.7
Box-R 200	198	198	362	222	-	494	-	397	8.8
Box-R 200 V2	198	198	362	222	-	494	-	397	8.8

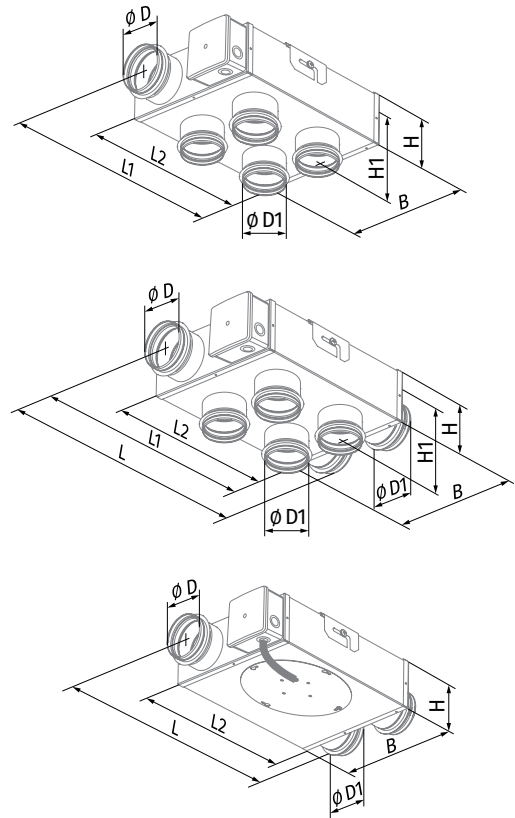

Technical data

Parameters	Box-R 80 V3			Box-R 100 V3		
	I	II	III	I	II	III
Speed						
Voltage [V / 50 Hz]		1 ~ 230			1 ~ 230	
Power [W]	20	26	45	20	26	45
Current [A]	0.32	0.34	0.4	0.32	0.34	0.4
Maximum air flow [m³/h (l/s)]	88 (24)	130 (36)	162 (45)	97 (27)	138 (38)	176 (49)
RPM [min⁻¹]	1400	1800	2600	1400	1800	2600
Sound pressure at 3 m [dBA]	32	35	43	33	36	44
Max. transported air temperature [°C]		+50			+50	
SEC class		C			C	
IP rating		IPX4			IPX4	
ErP		2018			2018	

BOX-R 80 V3

Sound power level, A-weighted	Total	Octave frequency bands [Hz]							LpA 3 m	LpA 1 m	
		63	125	250	500	1000	2000	4000			8000
LWA to inlet [dBA]	74	44	62	61	36	69	69	66	58	54	64
LWA to outlet [dBA]	74	46	56	64	39	68	70	65	59	53	63
LWA to environment [dBA]	64	40	48	48	54	59	57	52	46	43	53

BOX-R 100 V3

Sound power level, A-weighted	Total	Octave frequency bands [Hz]							LpA 3 m	LpA 1 m	
		63	125	250	500	1000	2000	4000			8000
LWA to inlet [dBA]	76	45	64	62	65	70	71	67	59	55	65
LWA to outlet [dBA]	75	47	57	65	63	69	72	66	60	55	65
LWA to environment [dBA]	65	41	49	55	59	60	58	53	47	44	54

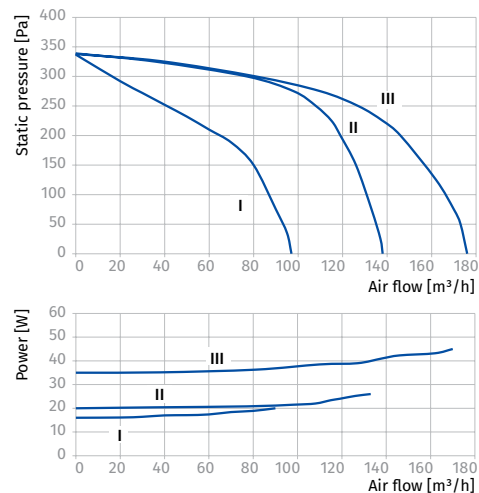
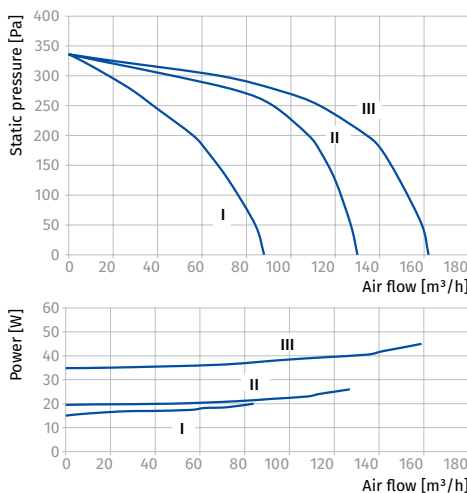

Parameters	Box-R 125	Box-R 125 max	Box-R 125 V2	
Speed	I	I	I	II
Voltage [V]	1 ~ 230	1 ~ 230	1 ~ 230	
Frequency [Hz]	50	50	50	
Power [W]	48	127	42	48
Current [A]	0.22	0.55	0.18	0.22
Maximum air flow [m ³ /h (l/s)]	242 (67)	414 (115)	220 (61)	300 (83)
RPM [min ⁻¹]	1430	2800	1960	2610
Sound pressure at 3 m [dBA]	37	47	39	45
Max. transported air temperature [°C]	+50	+50	+50	
SEC class	C	C	C	
IP rating	IPX4	IPX4	IPX4	
ErP	2018	2018	2018	

BOX-R 125

Sound power level, A-weighted	Total	Octave frequency bands [Hz]								LpA 3 m	LpA 1 m
		63	125	250	500	1000	2000	4000	8000		
LWA to inlet [dBA]	67	39	56	55	57	62	62	59	52	47	57
LWA to outlet [dBA]	67	41	50	57	55	61	63	58	53	46	56
LWA to environment [dBA]	58	36	43	48	52	53	51	47	41	37	47

BOX-R 125 MAX

Sound power level, A-weighted	Total	Octave frequency bands [Hz]								LpA 3 m	LpA 1 m
		63	125	250	500	1000	2000	4000	8000		
LWA to inlet [dBA]	78	46	66	66	68	73	74	70	61	58	68
LWA to outlet [dBA]	79	50	62	69	66	72	76	71	63	59	69
LWA to environment [dBA]	67	42	51	57	61	62	61	56	49	47	57

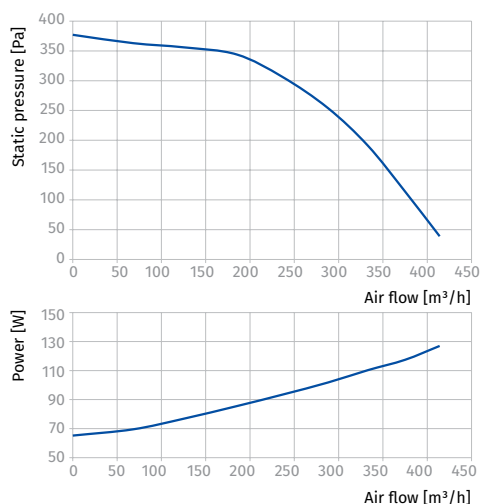
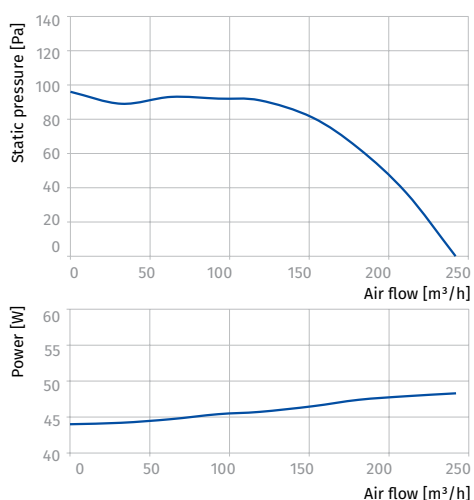

BOX-R 125 V2

Sound power level, A-weighted	Total	Octave frequency bands [Hz]								LpA 3 m	LpA 1 m
		63	125	250	500	1000	2000	4000	8000		
LWA to inlet [dBA]	76	45	64	63	66	70	71	67	59	55	65
LWA to outlet [dBA]	76	47	59	66	63	69	72	68	60	55	65
LWA to environment [dBA]	65	41	50	55	59	60	59	54	47	45	55

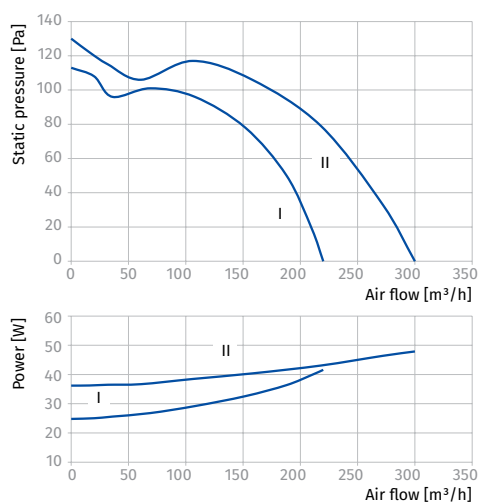

Parameters	Box-R 150	Box-R 150 V2		Box-R 200	Box-R 200 V2	
Speed	I	I	II	I	I	II
Voltage [V]	1 ~ 230	1 ~ 230		1 ~ 230	1 ~ 230	
Frequency [Hz]	50	50		50	50	
Power [W]	113	98	122	139	103	142
Current [A]	0.52	0.43	0.56	0.61	0.45	0.63
Maximum air flow [m³/h (l/s)]	536 (149)	356 (99)	533 (148)	783 (218)	460 (128)	752 (209)
RPM [min⁻¹]	1050	750	870	950	770	1200
Sound pressure at 3 m [dBA]	46	45	46	47	46	48
Max. transported air temperature [°C]	+50	+50		+50	+50	
SEC class	C	C		C	C	
IP rating	IPX4	IPX4		IPX4	IPX4	
ErP	2018	2018		2018	2018	

BOX-R 150

Sound power level, A-weighted	Total	Octave frequency bands [Hz]								LpA 3 m	LpA 1 m
		63	125	250	500	1000	2000	4000	8000		
LWA to inlet [dBA]	76	45	64	63	66	70	71	67	59	55	65
LWA to outlet [dBA]	78	48	61	67	65	71	74	70	62	57	67
LWA to environment [dBA]	66	41	50	56	60	61	60	54	48	46	56

BOX-R 150 V2

Sound power level, A-weighted	Total	Octave frequency bands [Hz]								LpA 3 m	LpA 1 m
		63	125	250	500	1000	2000	4000	8000		
LWA to inlet [dBA]	76	45	64	63	66	70	71	67	59	55	65
LWA to outlet [dBA]	77	49	59	66	65	71	73	68	62	56	66
LWA to environment [dBA]	66	42	49	55	59	61	61	56	45	46	56

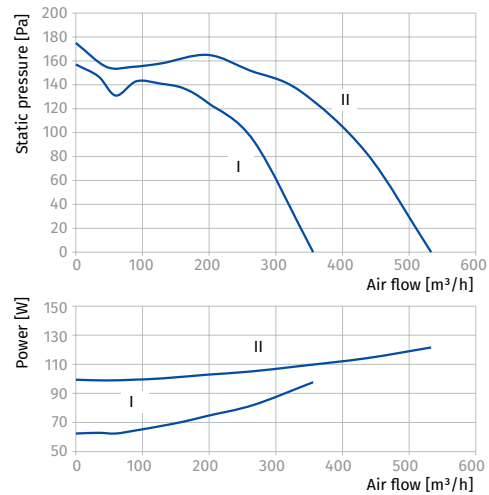
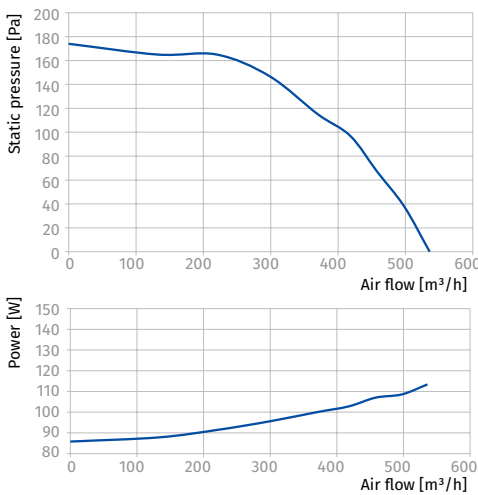

BOX-R 200

Sound power level, A-weighted	Total	Octave frequency bands [Hz]								LpA 3 m	LpA 1 m
		63	125	250	500	1000	2000	4000	8000		
LWA to inlet [dBA]	79	47	67	66	69	74	75	71	62	59	69
LWA to outlet [dBA]	79	50	60	67	66	73	75	70	63	58	68
LWA to environment [dBA]	67	43	50	56	60	62	62	57	46	47	57

BOX-R 200 V2

Sound power level, A-weighted	Total	Octave frequency bands [Hz]								LpA 3 m	LpA 1 m
		63	125	250	500	1000	2000	4000	8000		
LWA to inlet [dBA]	80	48	68	67	70	75	76	71	63	60	70
LWA to outlet [dBA]	79	51	61	68	67	74	70	70	63	59	69
LWA to environment [dBA]	68	43	51	57	61	63	58	58	47	48	58

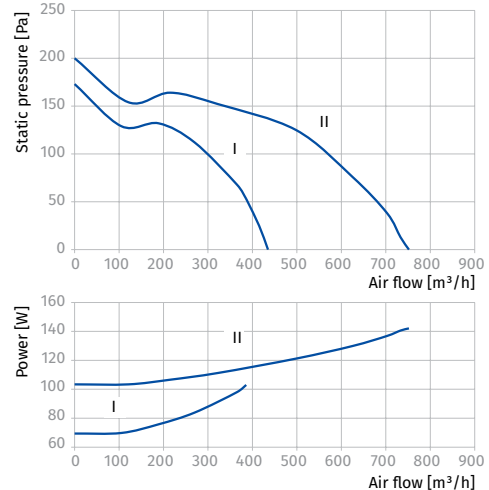
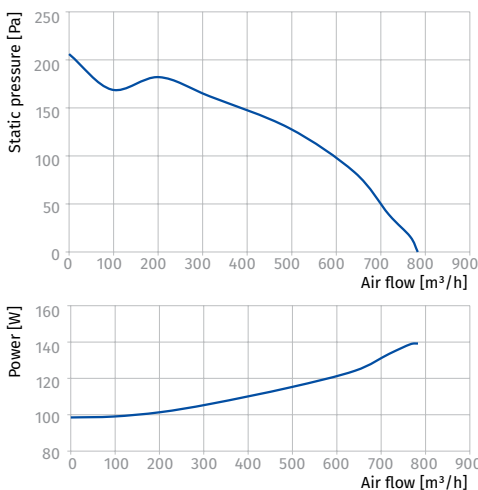

INLINE FANS

Altero 150

Inline mixed flow reversible fans

Use

- Ventilation for bathrooms and kitchens.
- Suitable for limited mounting space.
- Easy mounting.
- Compatible with Ø 150 mm round air ducts.



Air flow:
up to 320 m³/h
89 l/s



Power:
from 34 W



Noise level:
from 34 dBA



Design

- One fan providing supply and exhaust ventilation for different premises.
- The fan casing is equipped with mounting brackets for easy installation.
- Corrosion free.
- Collars with a rubber sealant prevent air leakage and pressure loss.
- The fan is equipped with a service door and removable ventilator block for easy maintenance.
- Built-in automatic control board.
- Built-in revision door for convenient maintenance.
- Vibration free operation.

Motor

- Specifically designed impellers provide a powerful, yet smooth and quiet air flow.
- Motor with thermal overload protection.
- Long-life ball bearing (up to 40 000 hours).
- Three-year warranty from time of installation.

Speed control

- Integrated controller provides automatic switching between supply and exhaust modes in accordance with code requirements.

Application example

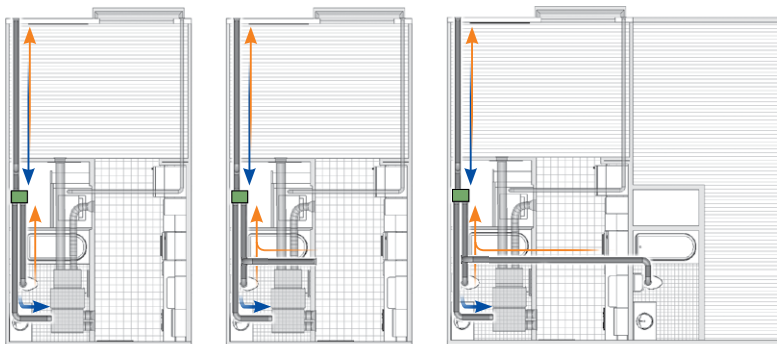

1 BATHROOM

1 BATHROOM + KITCHEN

2 BATHROOMS

Mounting

- The combination of supply and exhaust, along with a low profile housing, makes this fan suitable for low ceilings and tight spaces.
- One duct replacing the bathrooms, kitchen (when applicable) and outside air ducts.
- The amount of drop ceilings will be reduced due to eliminating ducts.
- Eliminates clearance requirements between outside air and bathrooms/kitchen (low rise).
- Easy installation.

Designation key

Series	Duct diameter [mm]
Altero	150

Accessories

Air disc valves



VPR / VSR / VMR

Duct system



BlauPlast

Flexible air ducts



BlauFlex

Grilles and hoods



Decor / GM

Clamps



K / KZ

Overall dimensions [mm]

Type	∅ D	∅ D1	H	B	B1	L	L1	L2
Altero 150	12	149	212	532	381	329	428	265

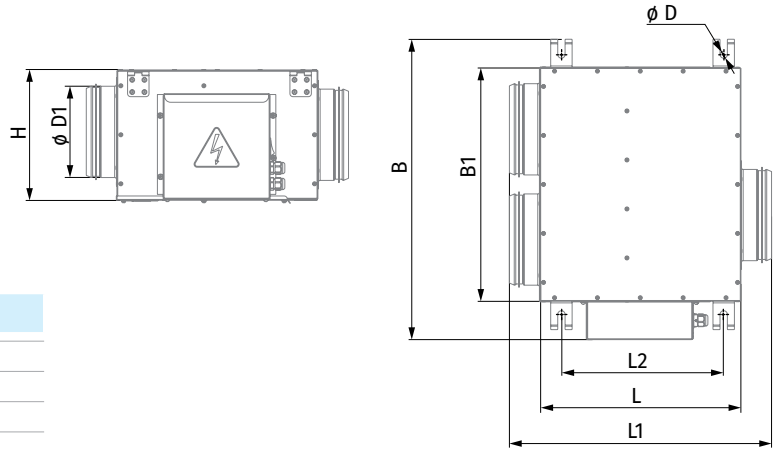

Technical data

Parameters	Altero 150
Voltage [V]	1 ~ 230
Frequency [Hz]	50/60
Power [W]	34
Current [A]	0.15
Maximum air flow [m³/h (l/s)]	320 (89)
RPM [min⁻¹]	2300
Sound pressure at 3 m [dBA]	34
Transported air temperature [°C]	60
IP rating	IPX4
SEC class	B
ErP	2018

ALTERO 150

Sound power level, A-weighted	Total	Octave frequency bands [Hz]								LpA 3 m	LpA 1 m
		63	125	250	500	1000	2000	4000	8000		
LWA to inlet [dBA]	60	20	31	57	51	51	50	39	27	39	49
LWA to outlet [dBA]	59	20	31	56	51	51	49	39	26	39	48
LWA to environment [dBA]	54	16	27	51	46	47	45	36	24	34	44

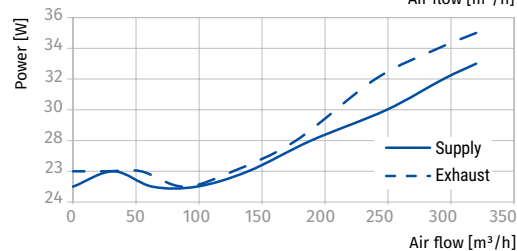
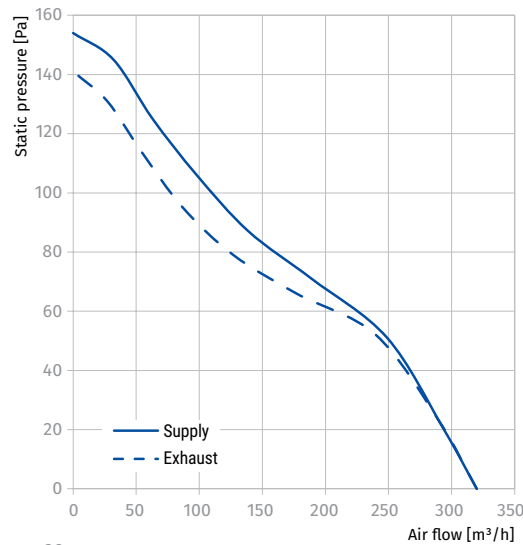

Ceileo

Exhaust centrifugal fans

Use

- Intermittent or continuous ventilation of bathrooms, showers, kitchens and other domestic spaces.
- For high-resistant ventilation systems.
- Compatible with Ø 100 or 150 mm air ducts.



Air flow:
up to 320 m³/h
89 l/s



Power:
from 20 W



Noise level:
from 24 dBA



Features

- Centrifugal extract low-noise and low-watt fans for ceiling mounting.
- Integrated LED-light with low energy demand (**Ceileo Light** models).
- Low noise level.
- The centrifugal impeller has forward curved blades for high pressure and low noise.
- The motor impeller is made of high-quality durable ABS plastic.
- The fans also feature a gravity backdraft damper.

Design

- The casing is made of galvanized steel.
- The clip-on plastic grille ensures easy mounting and cleaning of the fan.
- The modular design enables easy retrofitting with the optional humidity and motion sensors (except for the basic model) or the grille with a light.

Motor

- The Ceileo fans are equipped with reliable asynchronous two-speed motors with overheating protection.
- The maintenance-free permanently lubricated motor bearings are engineered for over 40 000 operating hours of trouble-free operation.

Options

- **Ceileo:** Double-speed basic fan model.
- **Ceileo T:** Models with an adjustable turn-off delay timer. This model can also be retrofitted with an optional humidity or motion sensor (available on a special order).

Mounting

- The fan is integrated into ceiling spaces.
- The fan is attached to the ceiling joists with spreader claws and self-tapping screws.
- The flexible air duct is attached to the fan exhaust spigot with a fixing clamp.

Control

- The built-in control panel of the Ceileo T fans enables the following settings:
 - turn-off delay
 - humidity level
 - air flow for the modes 1 and 2.

Name	Adjustment range for operation modes 1 and 2
Ceileo 200 (Light) T	Off / low speed / high speed
Ceileo 250 (Light) T	Off / low speed / high speed
Ceileo 300 (Light) T	Off / low speed / high speed

MANUAL CONTROL

The fan is controlled by means of the **CDP-2/10** speed switch (available as a specially ordered accessory).









AUTOMATIC CONTROL

- **Timer "T":** The fan is constantly set to Mode 1. The mode 2 is triggered by the light switch closing. Upon the light switch opening the built-in turn-off delay timer keeps the fan running in the mode 2 from 1 to 90 minutes. On elapsing of this period the fan reverts to the mode 1.
- **Timer "T" and humidity sensor** (specially ordered accessory): the fan runs constantly in the mode 1.
 - If the indoor humidity level exceeds the sensor threshold value set in the 50–90 % range, the fan switches to the mode 2.
 - When the humidity level reverts to the pre-set value, the built-in turn-off delay timer keeps the fan running in the mode 2 from 1 to 90 minutes. On elapsing of this period the fan reverts to the mode 1.
- **Timer "T" and motion sensor** (specially ordered accessory): the fan runs constantly in the mode 1.
 - If the motion sensor detects movement within its range, the fan goes to the mode 2. When the movement is no longer registered, the built-in turn-off delay timer keeps the fan running in the mode 2 from 1 to 90 minutes. On elapsing of this period the fan reverts to the mode 1.

Designation key

Series	Rated air flow [CFM]	LED-lamp available	Option
Ceileo	200; 250; 300	⌋: no LED-lamp Light: with LED-lamp	T

Accessories

Speed switch	Humidity sensor	Motion sensor	Ventilation hood	Ventilation hood	Flexible air ducts	Clamps	LED-lamp
							
CDP-2/10	HS Ceileo	IRS Ceileo	Decor S	Decor	BlauFlex	K	CH-PLC-10WG23

Overall dimensions [mm]

Type	∅ D	∅ d	L1	L2	A	B	C	E	H	h	a	b
Ceileo 200 / 250	148	98	100	45	330	258	260	395	188	18	-	-
Ceileo 200 / 250 Light	148	98	100	45	330	258	260	395	188	62	208	123
Ceileo 300	149	-	50	-	330	258	260	395	188	18	-	-
Ceileo 300 Light	149	-	50	-	330	258	260	395	188	62	208	123

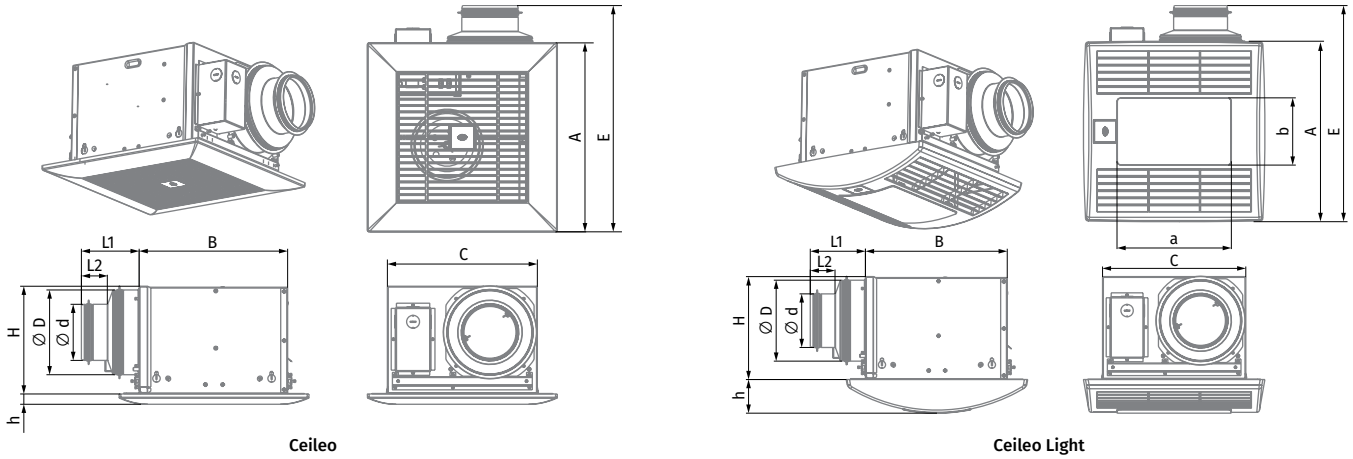

Technical data

Model	Ceileo 200 (Light) / Ceileo 200 (Light) T				Ceileo 250 (Light) / Ceileo 250 (Light) T				Ceileo 300 (Light) / Ceileo 300 (Light) T			
	min	max	min	max	min	max	min	max	min	max	min	max
Voltage [V/Hz]	230/50		230/60		230/50		230/60		230/50		230/60	
Power [W]	20	29	21	34	23	39	25	50	31	49	35	63
LED-light power [W]**	2 x 10				2 x 10				2 x 10			
RPM [min ⁻¹]	714	1026	588	936	756	1122	732	1140	936	1254	888	1320
Current [A]	0,1	0,13	0,11	0,15	0,12	0,18	0,14	0,22	0,15	0,22	0,17	0,28
Air flow [m ³ /h (l/s)]	130 (36)	210 (58)	130 (36)	225 (63)	170 (47)	260 (72)	160 (44)	270 (75)	220 (61)	300 (83)	200 (56)	320 (89)
SFP [W/l/s]	0,55	0,50	0,58	0,54	0,49	0,54	0,56	0,67	0,51	0,59	0,63	0,71
Sound pressure level [dBA]*	24	27	24	28	25	29	25	30	28	31	27	32
Weight [kg]	5,3 (6,4**)				5,3 (6,4**)				5,1 (6,2**)			
Ingress protection	IPX4				IPX4				IPX4			
SEC class***	C				C				C			

* Sound pressure level measured in free space at a distance of 3 meters from the fan.

** Only for the Light model

*** For fans with humidity or motion sensors

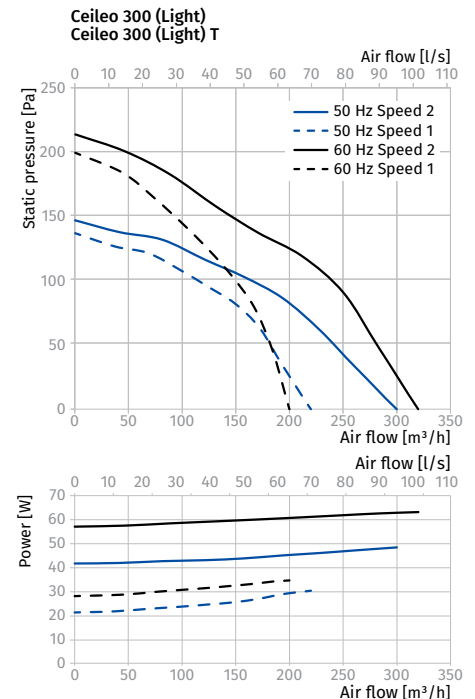
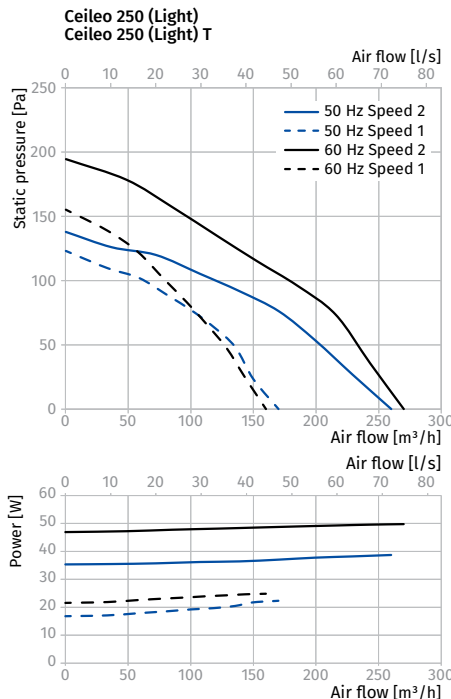
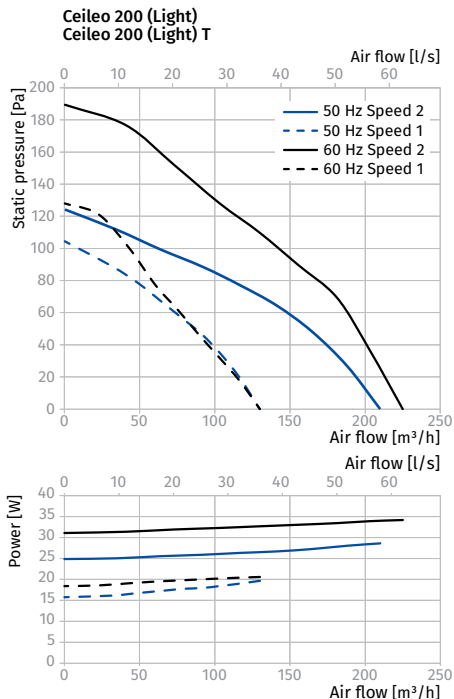

Ceileo DC

Exhaust centrifugal fans

Use

- Intermittent or continuous ventilation of bathrooms, showers, kitchens and other domestic spaces.
- For high-resistant ventilation systems.
- Compatible with Ø 100 or 150 mm air ducts.



Air flow:
up to 254 m³/h
71 l/s



Power:
from 19 W



Noise level:
from 23 dBA



Features

- Centrifugal extract low-noise and low-watt fans for ceiling mounting.
- DC motor with low energy demand.
- Integrated LED-light with low energy demand (**Ceileo DC Light** models)
- The modular design enables easy retrofitting with the optional humidity and motion sensors (except for the basic model) or the grille with a light.
- Low noise level.
- Constant air flow.
- The centrifugal impeller has forward curved blades for high pressure and low noise.
- The motor impeller is made of high-quality durable ABS plastic.
- The fans also features a gravity backdraft damper.

Design

- The casing is made of galvanized steel.
- The clip-on plastic grille ensures easy mounting and cleaning of the fan.
- The modular design enables easy retrofitting with the optional humidity and motion sensors (except for the basic model).

Motor

- The **Ceileo DC** fans feature high-efficient low-watt direct current motors with overheating protection.
- The constant air flow technology provides required air flow in a wide range of static pressure.

Options

- **Ceileo DC** fans include an integrated turn-off delay timer. The fan can also be retrofitted with an optional humidity or motion sensor (available on a special order).

Mounting

- The fan is integrated into ceiling spaces.
- The fan is attached to the ceiling joists with spreader claws and self-tapping screws.
- The flexible air duct is attached to the fan exhaust spigot with a fixing clamp.

Control

- The built-in control panel of the Ceileo T fans enables the following settings:
 - turn-off delay
 - humidity level
 - air flow for the modes 1 and 2.

Name	Adjustment range for operation modes 1 and 2
Ceileo DC 110 (Light)	Off / 100 / 120 / 135 / 155 / 170 / 190 m³/h
Ceileo DC 150 (Light)	Off / 100 / 120 / 135 / 155 / 170 / 190 / 205 / 220 / 240 / 250 m³/h

MANUAL CONTROL

The fan is controlled by means of the **CDP-2/10** speed switch (available as a specially ordered accessory).

AUTOMATIC CONTROL

- **Timer:** The fan is constantly set to Mode 1. The mode 2 is triggered by the light switch closing. Upon the light switch opening the built-in turn-off delay timer keeps the fan running in the mode 2 from 1 to 90 minutes. On elapsing of this period the fan reverts to the mode 1.
- **Timer and humidity sensor** (specially ordered accessory): the fan runs constantly in the mode 1.
 - If the indoor humidity level exceeds the sensor threshold value set in the 50–90 % range, the fan switches to the mode 2.
 - When the humidity level reverts to the pre-set value, the built-in turn-off delay timer keeps the fan running in the mode 2 from 1 to 90 minutes. On elapsing of this period the fan reverts to the mode 1.
- **Timer and movement sensor** (specially ordered accessory): the fan runs constantly in the mode 1.
 - If the motion sensor detects movement within its range, the fan goes to the mode 2. When the movement is no longer registered, the built-in turn-off delay timer keeps the fan running in the mode 2 from 1 to 90 minutes. On elapsing of this period the fan reverts to the mode 1.

Designation key

Series	Motor type	Rated air flow [CFM]	LED-lamp available
Ceileo	DC: DC motor	110; 150	-: no LED-lamp Light: with LED-lamp

Accessories

Speed switch	Humidity sensor	Motion sensor	Ventilation hood	Ventilation hood	Flexible air ducts	Clamps	LED-lamp
CDP-2/10	HS Ceileo	IRS Ceileo	Decor S	Decor	BlauFlex	K	CH-PLC-10WG23

Overall dimensions [mm]

Type	∅ D	∅ d	L1	L2	A	B	C	E	H	h	a	b
Ceileo DC 110	148	98	100	45	330	258	260	395	188	18	-	-
Ceileo DC 110 Light	148	98	100	45	330	258	260	395	188	62	208	123
Ceileo DC 150	149	-	50	-	330	258	260	395	188	18	-	-
Ceileo DC 150 Light	149	-	50	-	330	258	260	395	188	62	208	123

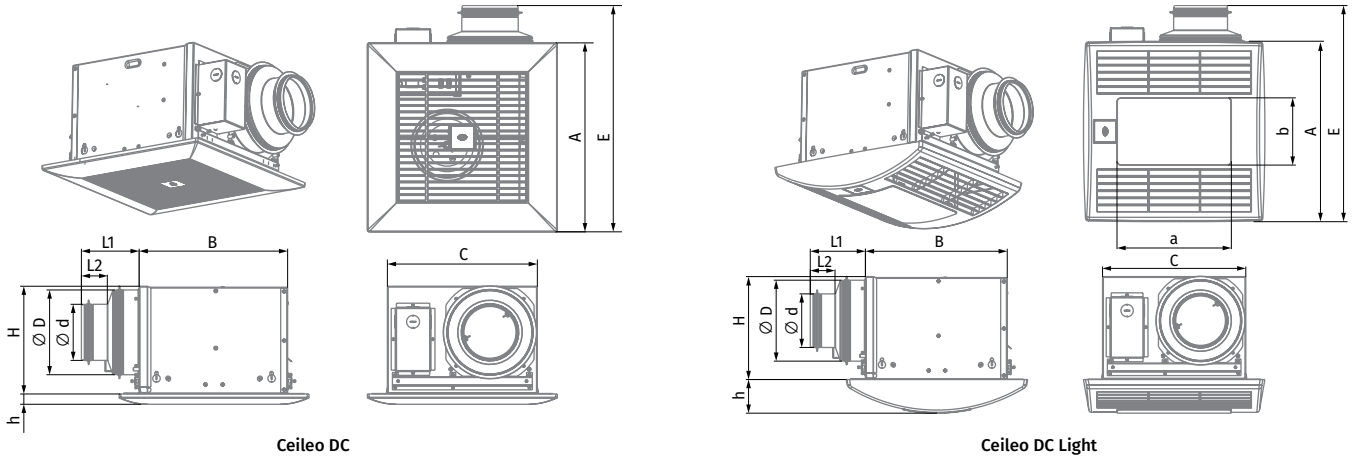

Technical data

Model	Ceileo DC 110 / Ceileo DC 110 Light	Ceileo DC 150 / Ceileo DC 150 Light
Voltage [V/Hz]	120-240/50(60)	120-240/50(60)
Power [W]	19	26
LED-light power [W]**	2 x 10	2 x 10
RPM [min ⁻¹]	1100	1100
Current @ 230 V (120 V) [A]	0.18 (0.3)	0.24 (0.39)
Air flow [m ³ /h (l/s)]	187 (52)	254 (71)
SFP [W/l/s]	0.37	0.37
Sound pressure level [dBA]*	23-25	23-29
Weight [kg]	5.3 (6.4**)	5.1 (6.2**)
Ingress protection	IPX4	IPX4
SEC class***	B	B

* Sound pressure level measured in free space at a distance of 3 meters from the fan.
 ** Only for the Light model
 *** For fans with humidity or motion sensors

Point	Ceileo DC 110 Ceileo DC 110 Light	Ceileo DC 150 Ceileo DC 150 Light
1	17	24
2	19	22
3	16	19
4	9	13
5	12	15
6	15	17
7	4	5
8	4	5
9	6	6

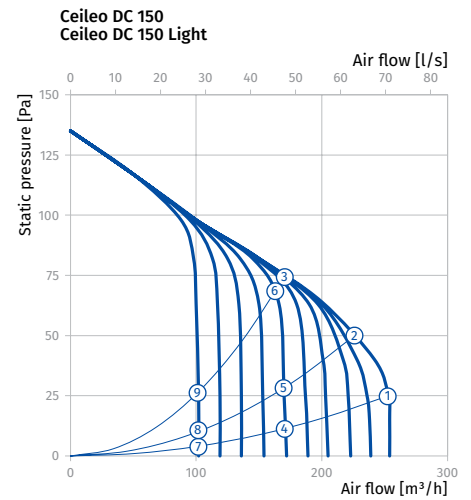
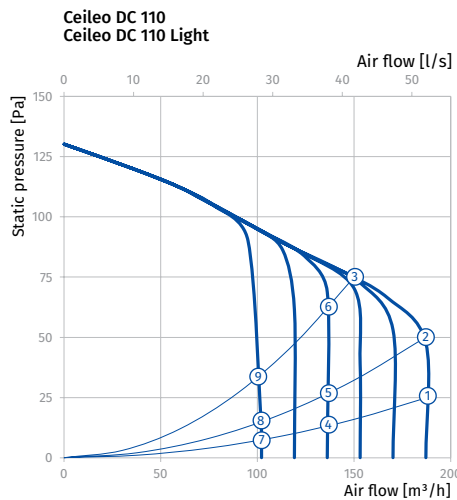

Ceileo Compact

Exhaust centrifugal fans

Use

- Intermittent or continuous ventilation of bathrooms, showers, kitchens and other domestic spaces.
- For high-resistant ventilation systems.
- Compatible with Ø 100 or 150 mm air ducts.



Air flow:
up to 270 m³/h
75 l/s



Power:
from 20 W



Noise level:
from 24 dBA



Features

- Integrated LED light with low energy demand (**Ceileo Compact Light** models).
- The modular design enables easy connection of the optional humidity or motion sensors (not accessible for the basic model) or the grille with a LED light.
- Constant air flow.
- Low noise level.
- The centrifugal impeller has forward curved blades for high pressure and low noise.
- The fan's impeller is made of high-quality durable ABS plastic.
- The fans also are equipped with a gravity backdraft damper.
- Ingress protection rating IPX4.
- Compatible with Ø 100 mm air ducts.

Motor

- The **Ceileo Compact** fans are equipped with reliable asynchronous two-speed motors with overheating protection.
- The maintenance-free permanently lubricated motor bearings are engineered for over 40 000 operating hours of trouble-free operation.

Design

- The casing is made of galvanized steel.
- The clip-on plastic grille ensures easy mounting and cleaning of the fan.
- The modular design of the grille enables easy retrofitting with the optional humidity or motion sensors.
- **Ceileo Compact Light** fans are equipped with an energy efficient LED light.

Options

Ceileo Compact: Double-speed basic fan model.

Ceileo Compact T: Models with an adjustable turn-on and turn-off delay timer.

This model can also be retrofitted with an optional humidity or motion sensor (available on a special order basis).

Designation key

Series	Rated air flow [CFM]	LED-lamp available	Option
Ceileo Compact	200; 250	_: no LED-lamp Light: with LED-lamp	T

Accessories

Speed switch	Humidity sensor	Motion sensor	Ventilation hood	Ventilation hood	Flexible air ducts	Clamps	LED-lamp
CDP-2/10	HS Ceileo	IRS Ceileo	Decor S	Decor	BlauFlex	K	CH-PLC-10WG23

Control

The built-in control panel of the **Ceileo Compact T** fans enables the following settings:

- turn-on delay by timer
- turn-off delay by timer
- humidity level
- air flow for the operating modes 1 and 2

Name	Adjustment range for operation modes 1 and 2
Ceileo Compact 200 T	Off / Speed 1/Speed 2
Ceileo Compact 250 T	Off / Speed 1/Speed 2

MANUAL CONTROL

The fan is controlled by means of the CDP-2/10 speed switch (available as a specially ordered accessory).

AUTOMATIC CONTROL

- **Timer:** The fan is continuously running in the mode 1. Upon the light switch closing, the fan goes to mode 2 after the turn-on delay timer countdown (from 0 to 3 minutes). Upon the light switch is turned off the built-in turn-off delay timer keeps the fan running in the mode 2 from 1 to 90 minutes. On elapsing of this period the fan reverts to the mode 1.
- **Timer and humidity sensor** (available as a specially ordered accessory): the fan runs continuously in the mode 1.
 - If the indoor humidity level exceeds the sensor threshold value set in the 50-90 % range, the fan switches to the mode 2.
 - When the humidity level reverts to the pre-set value, the built-in turn-off delay timer keeps the fan running in the mode 2 from 1 to 90 minutes. On elapsing of this period the fan reverts to the mode 1.
- **Timer and motion sensor** (available as a specially ordered accessory): the fan runs continuously in the mode 1.
 - If the motion sensor detects movement within its operation zone, the fan goes to the mode 2.
 - When the movement is no longer registered, the built-in turn-off delay timer keeps the fan running in the mode 2 from 1 to 90 minutes. On elapsing of this period the fan reverts to the mode 1.

Overall dimensions [mm]

Type	Ø d	L1	L2	A	B	C	E	H	h	G
Ceileo Compact 200/250	98	100	40.5	330	278	255	395	134	18	max 620
Ceileo Compact 200/250 Light	98	100	40.5	330	278	255	395	134	57	max 620

Mounting

- The fan is integrated into ceiling spaces.
- The fan is attached to the ceiling joists with a mounting bracket and self-tapping screws.
- The flexible air duct is attached to the fan exhaust spigot with a fixing clamp.
- Reduced casing height allows installing fans in ceilings with a thickness from 140 mm.

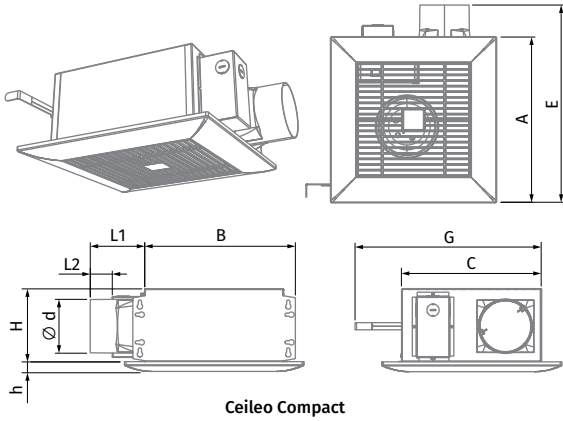

Ceileo Compact

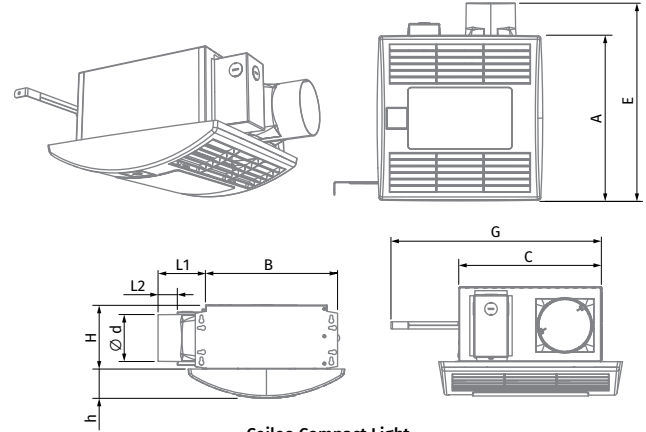

Ceileo Compact Light

Technical data

Model	Ceileo Compact 200 (Light) / Ceileo Compact 200 (Light) T				Ceileo Compact 250 (Light) / Ceileo Compact 250 (Light) T			
	min	max	min	max	min	max	min	max
Speed								
Voltage [V/Hz]	220-240/50		220-240/60		220-240/50		220-240/60	
Power [W]	20	29	21	34	23	39	25	50
LED-light power [W]**	2 x 10				2 x 10			
RPM [min ⁻¹]	714	1026	588	936	756	1122	732	1140
Current [A]	0,1	0,13	0,11	0,15	0,12	0,18	0,14	0,22
Air flow [m ³ /h (l/s)]	130 (36)	210 (58)	130 (36)	225 (63)	170 (47)	260 (72)	160 (44)	270 (75)
SFP [W/l/s]	0,55	0,50	0,58	0,54	0,49	0,54	0,56	0,67
Sound pressure level [dBA]*	24	27	24	28	25	29	25	30
Weight [kg]	5,3 (6,4**)				5,3 (6,4**)			
Ingress protection	IPX4				IPX4			
SEC class***	C				C			

* Sound pressure level measured in free space at a distance of 3 meters from the fan.
 ** Only for the Light model
 *** For fans with humidity or motion sensors

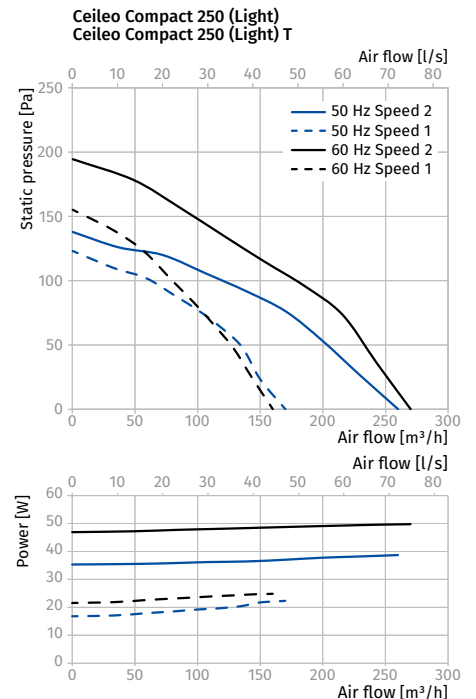
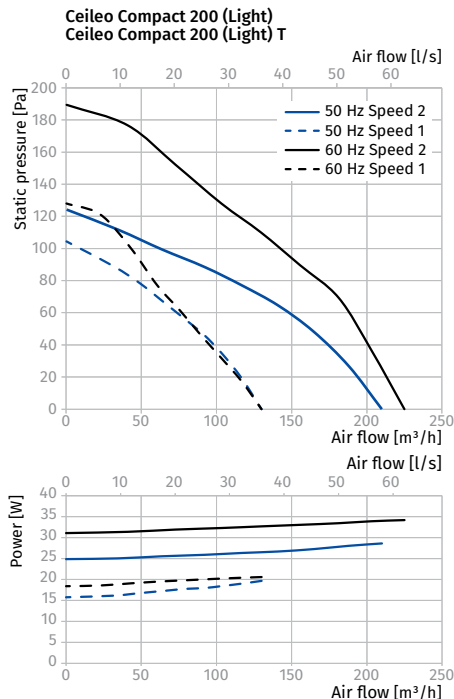

Ceileo Compact DC

Exhaust centrifugal fans

Use

- Intermittent or continuous ventilation of bathrooms, showers, kitchens and other domestic spaces.
- For high-resistant ventilation systems.
- Compatible with Ø 100 or 150 mm air ducts.



Air flow:
up to 187 m³/h
52 l/s



Power:
from 19 W



Noise level:
from 23 dBA



Features

- Integrated LED-light with low energy demand (**Ceileo Compact DC Light** models).
- The modular design enables easy connection of the optional humidity or motion sensors or the grille with a LED light.
- Constant air flow.
- Low noise level.
- The centrifugal impeller has forward curved blades for high pressure and low noise.
- The fan's impeller is made of high-quality durable ABS plastic.
- The fans also are equipped with a gravity backdraft damper.
- Ingress protection rating IPX4.
- Compatible with Ø 100 mm air ducts.

Motor

- The **Ceileo Compact DC** fan is equipped with a high efficient DC motor with low power consumption and electronic overheating protection. Constant air flow technology provides the necessary performance in a wide range of static pressure.

Design

- The casing is made of galvanized steel.
- The clip-on plastic grille ensures easy mounting and cleaning of the fan.
- The modular design of the grille enables easy retrofitting with the optional humidity or motion sensors.
- **Ceileo Compact DC Light** fans are equipped with an energy efficient LED light.

Options

Ceileo Compact DC: Models with an adjustable turn-off and turn-on delay timer.

This model can also be retrofitted with an optional humidity or motion sensor (available on a special order basis).

Designation key

Series	Motor type	Rated air flow [CFM]	LED-lamp available	Option
Ceileo Compact	DC: DC motor	110	_: no LED-lamp Light: with LED-lamp	T

Accessories

Speed switch

Humidity sensor

Motion sensor

Ventilation hood

Ventilation hood

Flexible air ducts

Clamps

LED-lamp



CDP-2/10



HS Ceileo



IRS Ceileo



Decor S



Decor



BlauFlex



K



CH-PLC-10WG23

Control

The built-in control panel of the **Ceileo Compact DC** fans enables the following settings:

- turn-on delay by timer
- turn-off delay by timer
- humidity level
- air flow for operating modes 1 and 2

Name	Adjustment range for operation modes 1 and 2
Ceileo Compact DC 110	Off / 100 / 120 / 135 / 155 / 170 / 190 m ³ /h

MANUAL CONTROL

The fan is controlled by means of the CDP-2/10 speed switch (available as a specially ordered accessory).

AUTOMATIC CONTROL

- **Timer:** The fan is continuously running in the mode 1. Upon the light switch closing, the fan goes to mode 2 after the turn-on delay timer countdown (from 0 to 3 minutes). Upon the light switch is turned off the built-in turn-off delay timer keeps the fan running in the mode 2 from 1 to 90 minutes. On elapsing of this period the fan reverts to the mode 1.
- **Timer and humidity sensor** (available as a specially ordered accessory): the fan runs continuously in the mode 1.
 - If the indoor humidity level exceeds the sensor threshold value set in the 50-90 % range, the fan switches to the mode 2.
 - When the humidity level reverts to the pre-set value, the built-in turn-off delay timer keeps the fan running in the mode 2 from 1 to 90 minutes. On elapsing of this period the fan reverts to the mode 1.
- **Timer and motion sensor** (available as a specially ordered accessory): the fan runs continuously in the mode 1.
 - If the motion sensor detects movement within its operation zone, the fan goes to the mode 2.
 - When the movement is no longer registered, the built-in turn-off delay timer keeps the fan running in the mode 2 from 1 to 90 minutes. On elapsing of this period the fan reverts to the mode 1.

Overall dimensions [mm]

Type	∅ d	L1	L2	A	B	C	E	H	h	G
Ceileo Compact DC 110	98	100	40.5	330	278	255	395	134	18	max 620
Ceileo Compact DC 110 Light	98	100	40.5	330	278	255	395	134	57	max 620

Mounting

- The fan is integrated into ceiling spaces.
- The fan is attached to the ceiling joists with a mounting bracket and self-tapping screws.
- The flexible air duct is attached to the fan exhaust spigot with a fixing clamp.
- Reduced casing height allows installing fans in ceilings with a thickness from 140 mm.

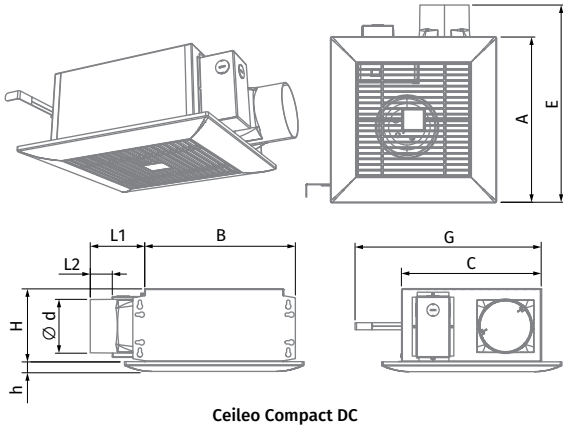

Ceileo Compact DC

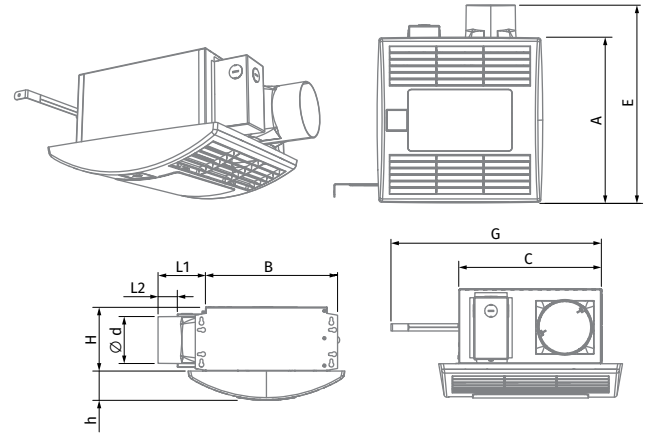

Ceileo Compact DC Light

Technical data

Model	Ceileo Compact DC 110 / Ceileo Compact DC 110 Light
Voltage [V/Hz]	120–240/50(60)
Speed	–
Power [W]	19
LED-light power [W]**	2 × 10
RPM [min ⁻¹]	1100
Current [A]	0.18
Air flow [m ³ /h (l/s)]	187 (52)
SFP [W/l/s]	0.37
Sound pressure level [dBA]*	23...25
Weight [kg]	5.3 (6.4**)
Ingress protection	IPX4
SEC class***	C

* Sound pressure level measured in free space at a distance of 3 meters from the fan.

** Only for the Light model

*** For fans with humidity or motion sensors

Point	Power [W]
1	17
2	19
3	16
4	9
5	12
6	15
7	4
8	4
9	6

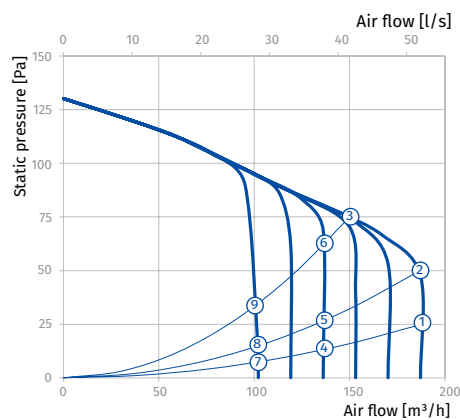

Box-D

Exhaust centrifugal fans

Use

- Extract ventilation systems installed in various premises.
- Mounting into suspended ceiling.
- Compatible with Ø 100, 125 and 150 mm round air ducts.



Air flow:
up to 531 m³/h
148 l/s



Power:
from 56 W



Noise level:
from 42 dBA



Design

- Compact galvanized steel casing.
- The front panel is made of ABS plastic and is equipped with a replaceable filter.
- The filter protects motor, impeller and air ducts against soiling.
- Fitted with a spring-loaded damper for back drafting prevention.
- The connection spigot is equipped with rubber seal.
- External terminal block for power supply.

Motor

- Single-phase external rotor motor. Centrifugal impeller with backward curved blades.
- Equipped with ball bearings for longer service life.
- Integrated thermal protection with automatic restart.
- Dynamically balanced impeller.

Speed control

- Smooth speed control with an external thyristor controller or step speed control with an external auto transformer (both available upon separate order).

Mounting

- The fan is installed between ceiling and false ceiling by fixing brackets supplied as a standard.
- Power is supplied to the fan through an external terminal box.
- Flexible air duct is fixed on the fan spigot with a clamp.

Modifications and options

- L: low-powered and low-noise motor.

Designation key

Series	Duct diameter [mm]	Options
Box-D	100; 125; 150	_ : standard motor L: low-powered motor

Overall dimensions [mm]

Type	Ø D	B	H	H1	L	Weight [kg]	Fig. No.
Box-D 100 L	100	240	160	189	305	2.9	1
Box-D 100	100	240	160	189	305	3.2	1
Box-D 125 L	125	240	160	189	305	2.9	1
Box-D 125	125	240	160	189	305	3.2	1
Box-D 150	149	355	180	215	419	6.5	2

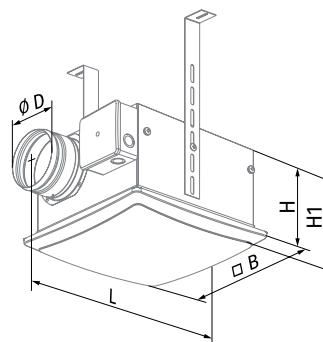

Fig. 1

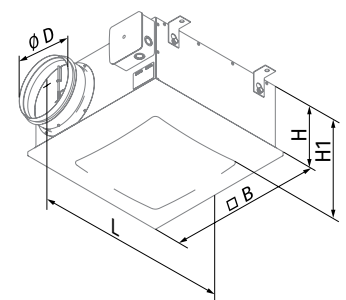

Fig. 2

Accessories

Silencers

Speed controllers

Timers/Sensors



SD



CDT E1.8



TE(TI) / HSE(HSI) / LSE(LSI) / IRSE(IRSI)

Technical data

Parameters	Box-D 100 L		Box-D 100		Box-D 125 L		Box-D 125		Box-D 150	
Voltage [V]	1 ~ 230		1 ~ 230		1 ~ 230		1 ~ 230		1 ~ 230	
Frequency [Hz]	50	60	50	60	50	60	50	60	50	60
Power [W]	56	58	61	79	56	58	61	81	112	136
Current [A]	0.34	0.35	0.26	0.35	0.34	0.35	0.26	0.36	0.5	0.6
Air flow [m³/h (l/s)]	190 (53)	205 (57)	240 (67)	250 (69)	225 (63)	240 (67)	310 (86)	320 (89)	485 (135)	531 (148)
RPM [min ⁻¹]	2300	2570	2500	2730	2300	2570	2500	2740	2465	2550
Sound pressure level at 3 m [dBA]	42	43	47	48	43	44	48	49	52	53
Transported air temperature [°C]	-25...+45		-25...+50		-25...+45		-25...+50		-25...+50	
SEC class	C		C		C		C		-	
IP rating	IPX4		IPX4		IPX4		IPX4		IPX4	
Motor IP rating	IP44		IP44		IP44		IP44		IP44	
ErP	2018		2018		2018		2018		2018	

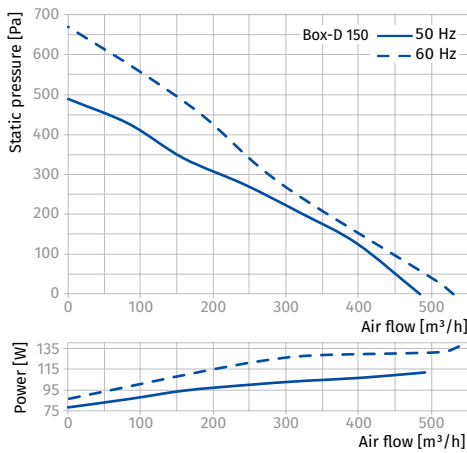
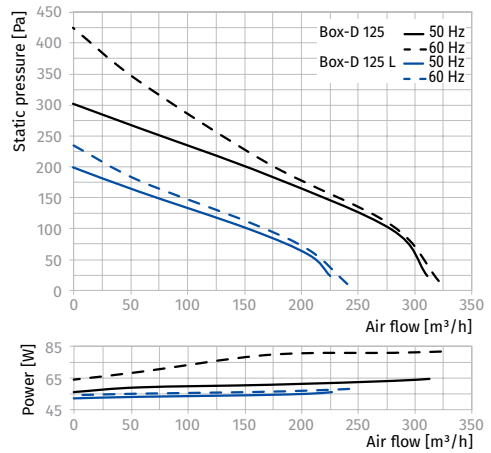
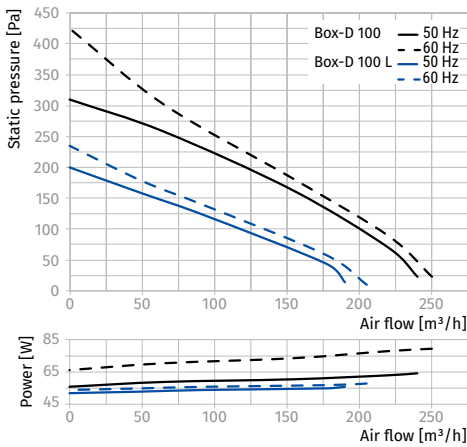

EXHAUST FANS

Extero

Exhaust centrifugal fans

Use

- Extract ventilation systems installed in various premises.
- External wall mounting from outside.
- Compatible with Ø 100 up to 200 mm round air ducts.



Air flow:
up to 710 m³/h
197 l/s



Power:
from 71 W



Noise level:
from 54 dBA



Design

- Steel casing with a special polymer atmospheric resistant coating.
- Special design of the casing protects the motor against direct sprays of water.
- Vertical air exhaust downwards through a protecting screen against birds and rodents.
- Back side has a special sealant for tight contact and adaption to the wall.
- The connection spigot is equipped with rubber seal.

Motor

- Single-phase external rotor motor with a centrifugal impeller with backward curved blades.
- Equipped with ball bearings for longer service life.
- Integrated thermal protection with automatic restart.
- Dynamically balanced impeller.

Speed control

- Smooth or step speed control with a thyristor or autotransformer speed controller (available upon order) connected to the maximum speed terminal of the motor.

Mounting

- Vertical mounting on external walls of buildings and premises.
- Flexible air duct is fixed on the fan spigot with a clamp.
- The fan with connected air duct is fixed at the wall on a mounting plate. Power supply through the external terminals. After mounting of the ventilator a protection cover is mounted over the mounting plate.

Designation key

Series	Duct diameter [mm]
Extero	100; 125; 150; 160; 200

Overall dimensions [mm]

Type	Ø D	B	H	L	Weight [kg]
Extero 100	99	260	355	138	4.1
Extero 125	124	260	355	138	4.1
Extero 150	149	300	400	138.2	4.5
Extero 160	159	300	400	138.2	4.5
Extero 200	199	300	400	138.2	4.5

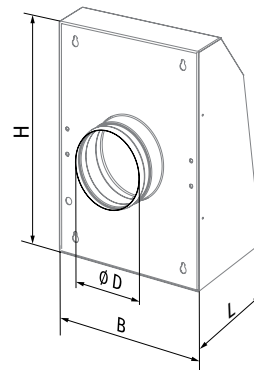

Accessories

Silencers	Backdraft air dampers	Air dampers	Clamps	Speed controllers	Timers/Sensors
 SD	 VRV	 VK / VKA	 KZ	 CDT E1.8	 TE(TI) / HSE(HSI) / LSE(LSI) / IRSE(IRSI)

Technical data

Parameters	Extero 100		Extero 125		Extero 150		Extero 160		Extero 200	
Voltage [V]	1 ~ 230		1 ~ 230		1 ~ 230		1 ~ 230		1 ~ 230	
Frequency [Hz]	50	60	50	60	50	60	50	60	50	60
Power [W]	71	92	75	98	96	100	95	96	96	97
Current [A]	0.31	0.4	0.33	0.43	0.42	0.44	0.41	0.42	0.42	0.42
Maximum air flow [m³/h (l/s)]	325 (90)	350 (97)	485 (135)	500 (139)	630 (175)	650 (181)	650 (181)	685 (190)	700 (194)	710 (197)
RPM [min⁻¹]	2530	2625	2475	2570	2400	2270	2440	2400	2515	2555
Sound pressure at 3 m [dBA]	54	54	54	54	58	58	60	60	62	62
Max. transported air temperature [°C]	+55		+55		+55		+55		+55	
SEC class	C		B		B		B		B	
IP rating	IPX4		IPX4		IPX4		IPX4		IPX4	
Motor IP rating	IP44		IP44		IP44		IP44		IP44	
ErP	2018		2018		2018		2018		2018	

EXTERO 100

Sound power level, A-weighted	Total	Octave frequency bands [Hz]							
		63	125	250	500	1000	2000	4000	8000
LWA to inlet [dBA]	60	46	52	58	58	58	51	40	28
LWA to environment [dBA]	58	39	40	49	55	60	56	43	35

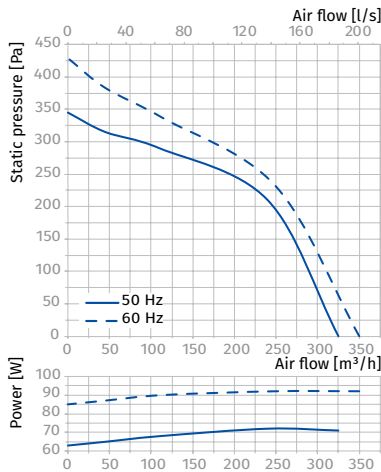

EXTERO 125

Sound power level, A-weighted	Total	Octave frequency bands [Hz]							
		63	125	250	500	1000	2000	4000	8000
LWA to inlet [dBA]	58	48	54	59	56	57	52	42	29
LWA to environment [dBA]	59	41	41	52	55	58	54	46	35

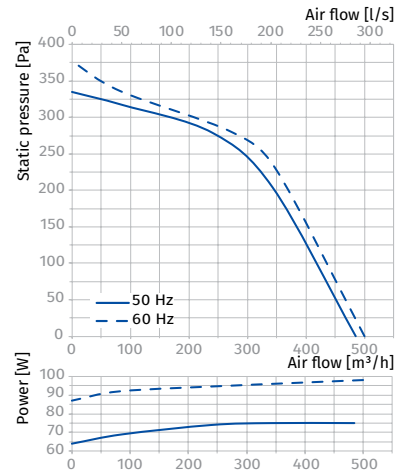

EXTERO 150, EXTERO 160

Sound power level, A-weighted	Total	Octave frequency bands [Hz]							
		63	125	250	500	1000	2000	4000	8000
EXTERO 150									
LWA to inlet [dBA]	57	45	53	54	57	56	46	38	19
LWA to environment [dBA]	56	48	38	48	52	54	49	39	32
EXTERO 160									
LWA to inlet [dBA]	55	44	54	55	58	54	46	36	18
LWA to environment [dBA]	54	46	39	49	51	53	49	42	31

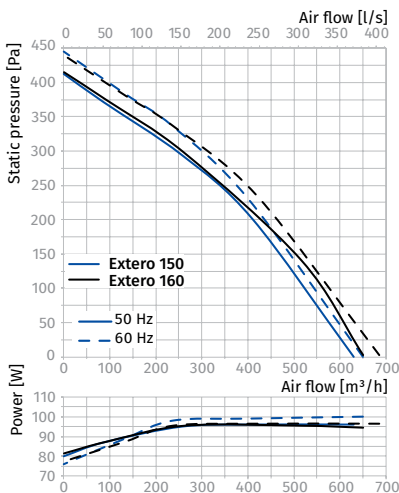

EXTERO 200

Sound power level, A-weighted	Total	Octave frequency bands [Hz]							
		63	125	250	500	1000	2000	4000	8000
LWA to inlet [dBA]	59	48	55	50	58	58	48	41	23
LWA to environment [dBA]	55	47	39	51	55	53	52	38	33

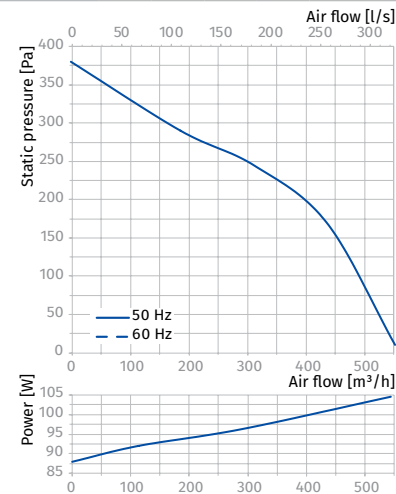

Extero EC

Exhaust centrifugal fans with EC motor

Use

- Extract ventilation systems installed in various premises.
- External wall mounting from outside.
- Compatible with Ø 100 up to 200 mm round air ducts.



Air flow:
up to 755 m³/h
210 l/s



Power:
from 79 W



Noise level:
from 55 dBA



Design

- Steel casing with a special polymer atmospheric resistant coating.
- Special design of the casing protects the motor against direct sprays of water.
- Back side has a special sealant for tight contact and adaption to the wall.
- Vertical air exhaust downwards through a protecting screen against birds and rodents.
- The connection spigot is equipped with rubber seal.

Motor

- High-efficient direct current EC motor with external rotor and backward curved blades.
- EC technology meets the up-to-date requirements to energy-saving and controllable ventilation and provides up to 35 % energy saving as compared to asynchronous motors.
- EC motor ensures totally controllable speed range for the fan and has integrated overheating protection with automatic restart.
- EC motor has no friction and wearing parts as capacitor and brushes. Instead a maintenance-free EC controller electronic circuit board is used.
- The impeller is dynamically balanced.
- The fan is compatible with 50 Hz and 60 Hz power mains and the maximum speed does not depend on power mains frequency.

Speed control

- The fan speed is controlled with a 0–10 V control signal from the following sources:
 - integrated or external speed controller
 - controller with sensors
 - central BMS system.
- The control signal value changes depending on air temperature, pressure, smoke concentration and other parameters.
- During signal value change the fan with EC motor correspondingly changes the rotations speed and delivers required air volume to the ventilation system.
- The computer central building management systems (BMS) enable integration of several EC motors in network and precise individual operation control for each fan.

Designation key

Series	Motor type	Duct diameter [mm]	Motor modifications
Extero	EC: electronically commutated motor	100; 125; 150; 160; 200	max: high-powered motor

Accessories

Silencers	Backdraft air dampers	Air dampers	Clamps	Speed controllers	Timers/Sensors
 SD	 VRV	 VK / VKA	 KZ	 CDT E/0-10	 TE(TI) / HSE(HSI) / LSE(LSI) / IRSE(IRSI)

Mounting

- Vertical mounting on external walls of buildings and premises.
- Flexible air duct is fixed on the fan spigot with a clamp.
- The fan with connected air duct is fixed at the wall on a mounting plate. Power supply through the external terminals. After mounting of the ventilator a protection cover is mounted over the mounting plate.

Overall dimensions [mm]

Type	Ø D	B	H	L	Weight [kg]
Extero EC 100	100	260	355	140	3.6
Extero EC 125	125	260	355	140	3.6
Extero EC 150	150	300	400	140	4.7
Extero EC 160	160	300	400	140	4.7
Extero EC 200	200	300	400	140	4.7
Extero EC 200 max	200	326	400	182	5.3

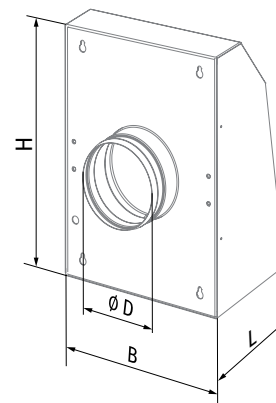

Technical data

Parameters	Extero EC 100	Extero EC 125	Extero EC 150	Extero EC 160	Extero EC 200	Extero EC 200 max
Voltage [V]	1 ~ 230	1 ~ 230	1 ~ 230	1 ~ 230	1 ~ 230	1 ~ 230
Frequency [Hz]	50/60	50/60	50/60	50/60	50/60	50/60
Power [W]	89	103	92	92	79	102
Current [A]	0.53	0.83	0.75	0.75	0.67	0.86
Maximum air flow [m³/h (l/s)]	313 (87)	480 (133)	550 (153)	585 (163)	535 (149)	755 (210)
RPM [min⁻¹]	3460	3600	2840	2840	2680	2800
Sound pressure at 3 m [dBA]	55	57	56	55	55	58
Max. transported air temperature [°C]	-25...+40	-25...+40	-25...+40	-25...+40	-25...+40	-25...+40
SEC class	B	B	B	B	B	B
IP rating	IPX4	IPX4	IPX4	IPX4	IPX4	IPX4
Motor IP rating	IP55	IP55	IP55	IP55	IP55	IP55
ErP	2018	2018	2018	2018	2018	2018

EXTERO EC 100

Sound power level, A-weighted	Total	Octave frequency bands [Hz]								LpA 3 m	LpA 1 m
		63	125	250	500	1000	2000	4000	8000		
LWA to inlet [dBA]	71	60	57	62	65	67	62	56	49	50	60
LWA to environment [dBA]	76	33	44	62	73	68	68	62	51	55	65

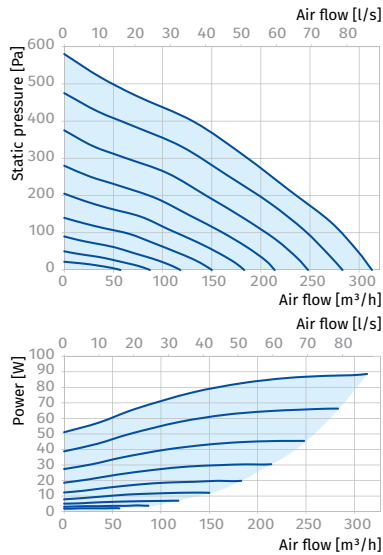

EXTERO EC 125

Sound power level, A-weighted	Total	Octave frequency bands [Hz]								LpA 3 m	LpA 1 m
		63	125	250	500	1000	2000	4000	8000		
LWA to inlet [dBA]	73	62	59	64	67	69	64	58	51	52	62
LWA to environment [dBA]	78	34	45	64	75	71	71	64	53	57	67

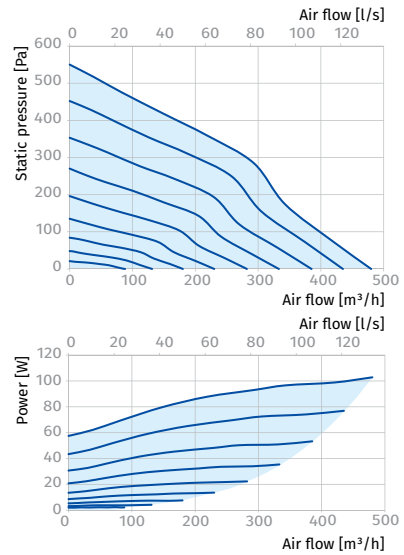

EXTERO EC 150

Sound power level, A-weighted	Total	Octave frequency bands [Hz]								LpA 3 m	LpA 1 m
		63	125	250	500	1000	2000	4000	8000		
LWA to inlet [dBA]	80	68	65	72	76	71	70	67	61	59	69
LWA to environment [dBA]	77	43	53	66	72	70	71	66	60	56	66

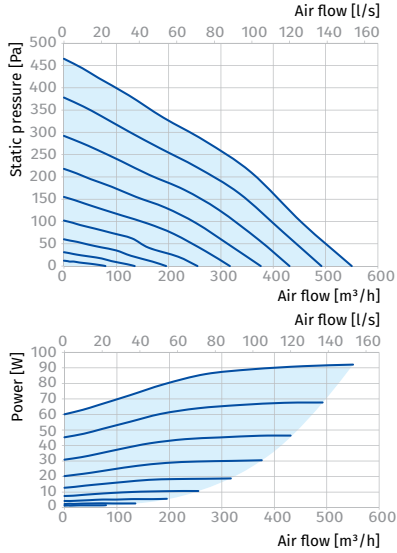

EXTERO EC 160

Sound power level, A-weighted	Total	Octave frequency bands [Hz]								LpA 3 m	LpA 1 m
		63	125	250	500	1000	2000	4000	8000		
LWA to inlet [dBA]	79	62	68	73	74	72	66	64	56	58	68
LWA to environment [dBA]	76	40	52	68	71	70	68	61	52	55	65

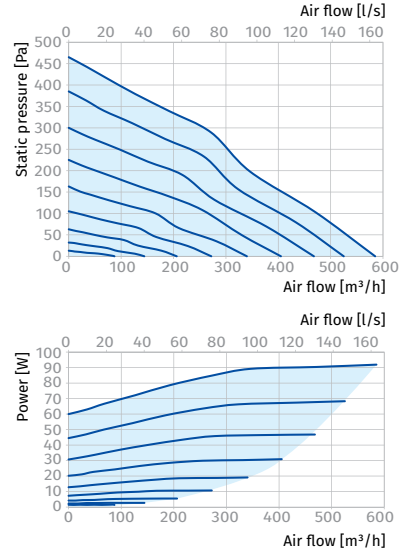

EXTERO EC 200

Sound power level, A-weighted	Total	Octave frequency bands [Hz]								LpA 3 m	LpA 1 m
		63	125	250	500	1000	2000	4000	8000		
LWA to inlet [dBA]	79	59	61	67	76	71	69	67	60	58	68
LWA to environment [dBA]	75	42	52	65	71	69	70	65	59	55	65

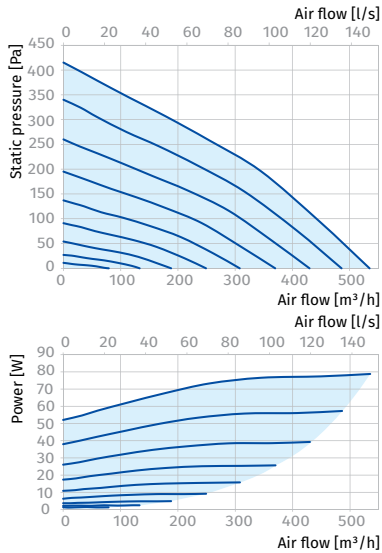

EXTERO EC 200 MAX

Sound power level, A-weighted	Total	Octave frequency bands [Hz]								LpA 3 m	LpA 1 m
		63	125	250	500	1000	2000	4000	8000		
LWA to inlet [dBA]	82	61	63	69	80	73	71	69	62	61	71
LWA to environment [dBA]	79	44	55	68	74	72	73	68	62	58	68

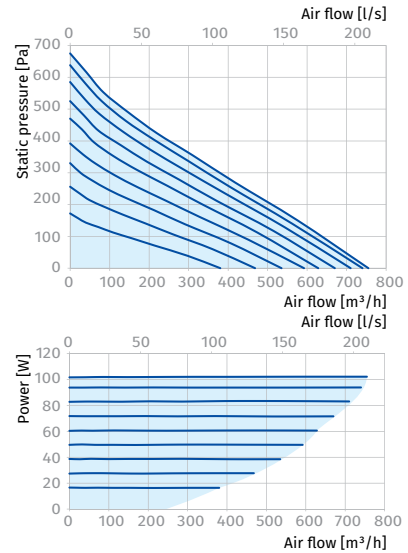

EXHAUST FANS

Iso-Mix

Sound-insulated inline mixed-flow fans

Use

- Supply and extract ventilation systems installed in various premises with high requirements to the noise level.
- For ventilation air ducts requiring high pressure, powerful air flow and low noise level.
- Compatible with Ø 100 up to Ø 315 mm air ducts.



Air flow:
up to 1920 m³/h
533 l/s



Power:
from 24 W



Noise level:
from 23 dBA



Design

- The casing is made of polymer-coated steel, internally filled with 50 mm mineral wool thermal- and sound-insulating layer.
- Special inner perforation of the casing and sound-insulating material are designed for wide-frequency sound absorbing.
- Mixed-flow impeller made of high-quality plastic.
- The diffusor, the specially profiled impeller and directing vanes provide high performance and powerful pressure combined with low noise operation.
- External airtight terminal block on the fan casing for power supply.
- Mounting brackets on the fan casing for mounting to the floor, to the wall or ceiling.

Motor

- Double-speed single-phase high-efficient motor with low energy demand on ball bearings.
- Overheating protection due to built-in thermal switches.
- Motor ingress protection rating IPX4.

Speed control

- Speed selection with a built-in speed switch (US option) or an external multi-speed controller (specially ordered accessory).
- Smooth speed control is possible either with an integrated speed controller (FR1 option), an external thyristor or transformer speed controller (specially ordered accessory) when connected to the maximum speed terminal.

Mounting

- Due to its compact design the fan is the ideal solution for mounting in limited spaces.
- The fan is suitable for mounting in any section of the ventilation system from intake to the end of the ductwork.
- Wall or ceiling mounting with a special mounting plate on the fan casing.

Modifications and options

- T:** turn-off delay timer adjustable from 2 to 30 minutes.
- US:** three-position speed switch.
- FR1:** smooth speed controller adjustable from 0 to 100 % and power cable with mains plug.



- G1:** speed controller, temperature controller with external temperature sensor (cable length 4 m), power cable with mains plug.



- GT1:** speed controller, temperature controller with external temperature sensor (cable length 4 m), 5 min timer switch and power cable with mains plug.
- GI1:** speed controller, temperature controller with integrated temperature sensor and power cable with mains plug.
- GTI1:** speed controller, temperature controller with integrated temperature sensor, 5 min timer switch and power cable with mains plug.
- The **G1** and **GI1** modifications enable automatic speed control depending on indoor temperature. The optimal ventilation solution for premises requiring permanent temperature control as greenhouses, orangeries, etc.
- W1:** power cable with mains plug.

Accessories

Silencers	Filter boxes	Electric heaters	Water heaters	Backdraft air dampers	Air dampers	Clamps	Temperature controllers	Speed controllers	Timers/Sensors
SD	KFBK / KFBT	EKH	WKH	VRV	VK / VKA	K	MLCD E2	CDP / CDT	TE(TI) / HSE(HSI) / LSE(LSI) / IRSE(IRSI)

Designation key		
Series	Duct diameter [mm]	Options
Iso-Mix	100; 125; 150; 160; 200; 250; 315	<p>T: turn-off delay timer adjustable from 2 to 30 minutes</p> <p>US: three-position speed switch</p> <p>FR1: smooth speed controller adjustable from 0 to 100 % and power cable with mains plug</p> <p>G1: speed controller, temperature controller with external temperature sensor, power cable with mains plug</p> <p>GT1: speed controller, temperature controller with external temperature sensor, 5 min timer switch and power cable with mains plug</p> <p>GI1: speed controller, temperature controller with integrated temperature sensor and power cable mains plug</p> <p>GTI1: speed controller, temperature controller with integrated temperature sensor, 5 min timer switch and power cable with mains plug</p> <p>W1: power cable with mains plug</p>

Overall dimensions [mm]

Type	Ø D	B	B1	L	H	Weight [kg]
Iso-Mix 100	98	214	243	505	251	4.6
Iso-Mix 125	123	214	243	474	251	4.6
Iso-Mix 150	148	247	273	579	263	6.1
Iso-Mix 160	159	281	327	566	284	6.3
Iso-Mix 200	198	293	386	550	295	8
Iso-Mix 250	248	358	445	658	360	15
Iso-Mix 315	313	432	520	780	434	25

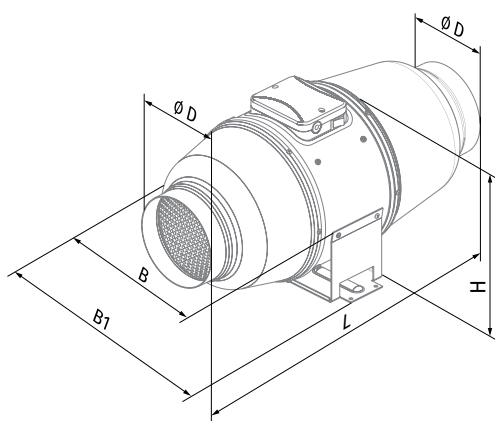

Iso-Mix 100 – Iso-Mix 150

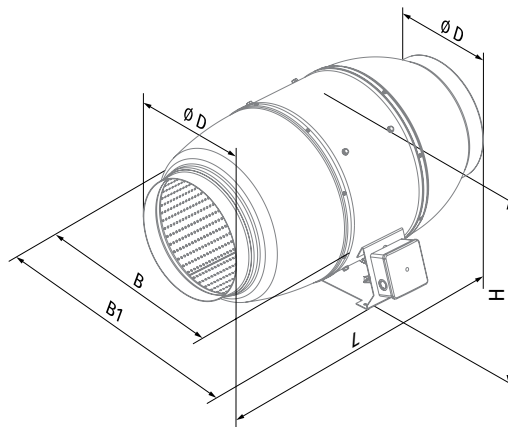

Iso-Mix 160 – Iso-Mix 315

SOUND-INSULATED INLINE FANS

Technical data

Parameters	Iso-Mix 100		Iso-Mix 125	
	min	max	min	max
Speed				
Voltage [V]	1 ~ 230		1 ~ 230	
Frequency [Hz]	50/60		50/60	
Power [W]	24	26	25	29
Current [A]	0.10	0.11	0.11	0.13
Maximum air flow [m ³ /h (l/s)]	175 (49)	233 (65)	235 (65)	347 (96)
RPM [min ⁻¹]	2015	2610	1660	2315
Sound pressure at 3 m [dBA]	24	29	23	28
Max. transported air temperature [°C]	+60		+60	
SEC class	-		-	
IP rating	IPX4		IPX4	
Motor IP rating	IP44		IP44	
ErP	-		-	

ISO-MIX 100

Sound power level, A-weighted	Total	Octave frequency bands [Hz]								LpA 3 m	LpA 1 m
		63	125	250	500	1000	2000	4000	8000		
Min speed											
LWA to inlet [dBA]	55	29	45	51	49	48	35	26	14	34	44
LWA to outlet [dBA]	53	30	35	38	52	45	38	38	25	33	43
LWA to environment [dBA]	44	29	31	36	38	39	36	31	24	24	34
Max speed											
LWA to inlet [dBA]	61	33	51	57	55	54	39	29	16	40	50
LWA to outlet [dBA]	58	33	38	41	57	50	41	41	27	37	47
LWA to environment [dBA]	49	36	42	45	44	37	34	24	18	29	39

ISO-MIX 125

Sound power level, A-weighted	Total	Octave frequency bands [Hz]								LpA 3 m	LpA 1 m
		63	125	250	500	1000	2000	4000	8000		
Min speed											
LWA to inlet [dBA]	60	32	50	56	54	53	38	29	16	39	49
LWA to outlet [dBA]	58	40	43	50	52	54	50	43	33	38	48
LWA to environment [dBA]	44	35	38	39	37	29	23	18	12	23	33
Max speed											
LWA to inlet [dBA]	64	35	54	60	58	56	41	31	17	43	53
LWA to outlet [dBA]	61	35	40	44	60	53	44	44	29	40	50
LWA to environment [dBA]	48	35	40	44	43	38	34	25	20	28	38

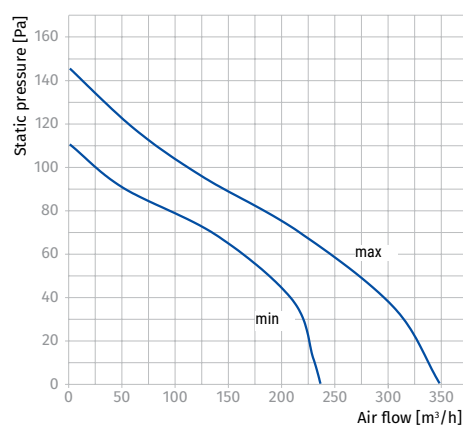
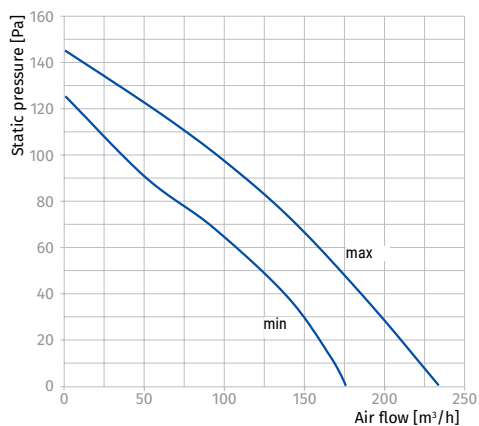

Parameters	Iso-Mix 150, Iso-Mix 160		Iso-Mix 200	
	min	max	min	max
Speed				
Voltage [V]	1 ~ 230		1 ~ 230	
Frequency [Hz]	50/60		50/60	
Power [W]	45	52	78	110
Current [A]	0.20	0.23	0.35	0.49
Maximum air flow [m³/h (l/s)]	410 (114)	550 (153)	790 (219)	1035 (288)
RPM [min ⁻¹]	1985	2640	2000	2460
Sound pressure at 3 m [dBA]	26	33	31	36
Max. transported air temperature [°C]	+60		+60	
SEC class	C		C	
IP rating	IPX4		IPX4	
Motor IP rating	IP44		IP44	
ErP	2018		2018	

ISO-MIX 150, ISO-MIX 160

Sound power level, A-weighted	Total	Octave frequency bands [Hz]								LpA 3 m	LpA 1 m
		63	125	250	500	1000	2000	4000	8000		
Min speed											
LWA to inlet [dBA]	59	32	49	55	53	52	38	28	15	38	48
LWA to outlet [dBA]	62	36	41	44	61	53	44	44	29	41	51
LWA to environment [dBA]	47	37	40	41	40	38	29	22	19	26	36
Max speed											
LWA to inlet [dBA]	68	37	58	65	62	61	44	33	18	48	58
LWA to outlet [dBA]	66	38	43	47	65	57	47	47	31	45	55
LWA to environment [dBA]	53	44	47	48	47	45	34	26	23	33	43

ISO-MIX 200

Sound power level, A-weighted	Total	Octave frequency bands [Hz]								LpA 3 m	LpA 1 m
		63	125	250	500	1000	2000	4000	8000		
Min speed											
LWA to inlet [dBA]	63	34	53	60	57	56	41	31	17	43	53
LWA to outlet [dBA]	62	43	46	53	56	58	53	46	36	41	51
LWA to environment [dBA]	52	40	46	46	44	41	37	35	30	31	41
Max speed											
LWA to inlet [dBA]	69	38	59	66	63	62	45	34	18	49	59
LWA to outlet [dBA]	67	39	44	48	66	58	48	48	32	47	57
LWA to environment [dBA]	57	44	52	52	49	45	41	39	34	36	46

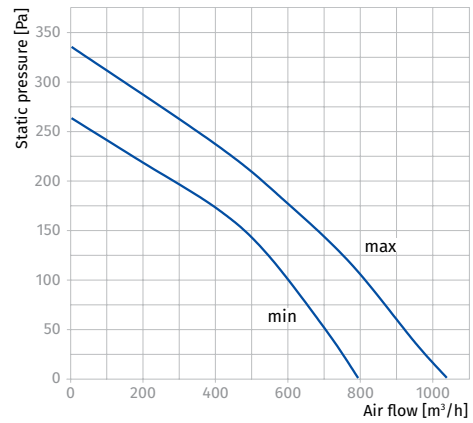
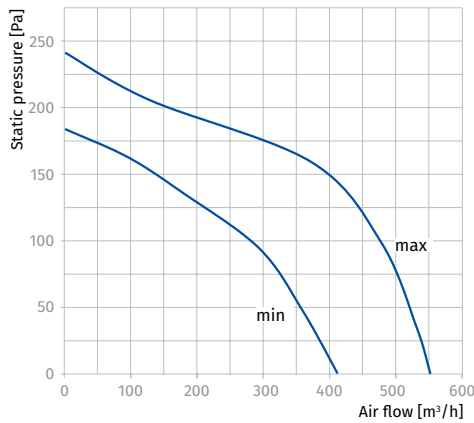

Parameters	Iso-Mix 250		Iso-Mix 315	
Speed	min	max	min	max
Voltage [V]	1 ~ 230		1 ~ 230	
Frequency [Hz]	50/60		50/60	
Power [W]	127	178	230	330
Current [A]	0.52	0.79	0.93	1.41
Maximum air flow [m³/h (l/s)]	1035 (288)	1315 (365)	1510 (419)	1920 (533)
RPM [min ⁻¹]	1960	2460	2120	2620
Sound pressure at 3 m [dBA]	34	38	36	40
Max. transported air temperature [°C]	+60		+60	
SEC class	-		-	
IP rating	IPX4		IPX4	
Motor IP rating	IP44		IP44	
ErP	2018		2018	

ISO-MIX 250

Sound power level, A-weighted	Total	Octave frequency bands [Hz]								LpA 3 m	LpA 1 m
		63	125	250	500	1000	2000	4000	8000		
Min speed											
LWA to inlet [dBA]	66	36	56	63	60	59	43	32	17	45	55
LWA to outlet [dBA]	64	37	42	46	63	55	46	46	30	43	53
LWA to environment [dBA]	55	44	48	51	47	44	37	31	25	34	44
Max speed											
LWA to inlet [dBA]	69	38	59	66	63	62	45	34	18	49	59
LWA to outlet [dBA]	75	43	50	54	74	65	54	54	36	54	64
LWA to environment [dBA]	58	47	49	53	53	49	44	39	31	38	48

ISO-MIX 315

Sound power level, A-weighted	Total	Octave frequency bands [Hz]								LpA 3 m	LpA 1 m
		63	125	250	500	1000	2000	4000	8000		
Min speed											
LWA to inlet [dBA]	67	36	57	63	61	59	43	32	18	46	56
LWA to outlet [dBA]	65	45	48	56	59	61	56	48	37	44	54
LWA to environment [dBA]	56	47	47	52	50	45	41	37	29	36	46
Max speed											
LWA to inlet [dBA]	70	38	60	67	64	62	45	34	18	49	59
LWA to outlet [dBA]	71	50	53	62	65	67	62	53	41	50	60
LWA to environment [dBA]	60	51	52	54	55	50	46	43	35	40	50

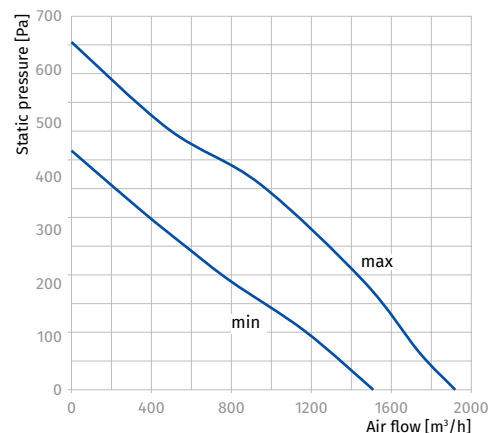
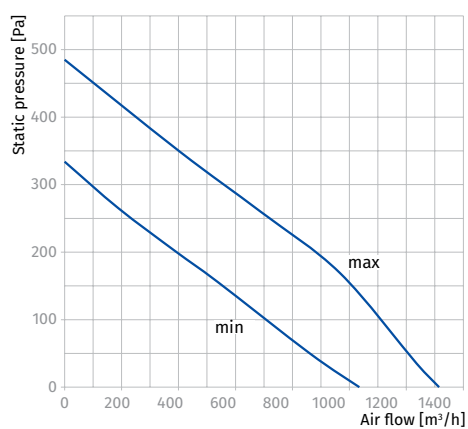

Iso-Mix EC

Sound-insulated inline mixed-flow fans with EC motor

Use

- Combined supply and exhaust ventilation systems of various commercial and industrial spaces with stringent noise requirements (such as libraries, conference halls, classrooms, kindergarten playrooms etc.).
- For ventilation air ducts requiring high pressure, powerful air flow and low noise level.
- Compatible with Ø 100 up to Ø 315 mm air ducts.



Air flow:
up to 1970 m³/h
547 l/s



Power:
from 30 W



Noise level:
from 37 dBA



Features

- The new series of **Iso-Mix EC** duct fan series is provided with a special sound-insulated casing which ensures silent operation and excellent aerodynamic characteristics.
- **Iso-Mix EC** fans combine the versatility and outstanding performance of both axial and centrifugal fans producing a powerful air flow and high pressure while retaining the signature energy-efficiency and response of EC motors.
- Several fans can be integrated into a single computer-controlled system with sensor feedback combined with speed control across the entire dynamic range.

Design

- The external casing is made of steel with a polymer coating.
- The internal casing perforations conduct sound waves and direct them at the noise-absorbing material at a specific angle. Noise and heat insulation is ensured by a mineral wool layer 50 mm in thickness. Wideband noise control is achieved by means of special casing perforation and the use of noise-absorbing material.
- The inner casing and the impeller are made of durable high-quality plastic.
- Conical impellers with specially profiled blades help boost angular velocity of the air flow resulting in higher pressure and air capacity compared to the conventional designs. The combination of a diffuser, a specially designed impeller and flow straightener vanes at the fan outlet allow for an optimum flow distribution to achieve high capacity and increased air pressure without generating excessive noise.
- The fan casing is equipped with an external water-tight terminal box for electrical connections.

Motor

- High-efficient direct current EC motor.
- EC technology meets the up-to-date requirements to energy-saving and controllable ventilation and provides up to 35 % energy saving as compared to asynchronous motors.
- EC motor ensures totally controllable speed range for the fan and has integrated overheating protection with automatic restart.
- EC motor has no friction and wearing parts as capacitor and brushes. Instead a maintenance-free EC controller electronic circuit board is used.
- The impeller is dynamically balanced.
- The fan is compatible with 50 Hz and 60 Hz power mains and the maximum speed does not depend on power mains frequency.

Speed control

- The fan speed is controlled with a 0–10 V control signal from the following sources:
 - integrated or external speed controller
 - controller with sensors
 - central BMS system.
- The control signal value changes depending on air temperature, pressure, smoke concentration and other parameters.
- During signal value change the fan with EC motor correspondingly changes the rotations speed and delivers required air volume to the ventilation system.
- The computer central building management systems (BMS) enable integration of several EC motors in network and precise individual operation control for each fan.

Mounting

- The fans are designed to be used with round air ducts.
- The fan casing has mounting brackets for convenient installation onto the floor, walls or ceiling. The ducts can be fitted at any angle relative to the fan axis.
- Make sure to provide sufficient maintenance access during fan installation. Electrical connection and installation must be performed in accordance with the instruction manual and the electrical connections diagram applied to the terminal box.
- A single system may have several fans installed in parallel to boost the output capacity or in series to boost the working pressure.

Designation key

Series	Motor type	Spigot diameter [mm]
Iso-Mix	EC: electronically commutated motor	100; 125; 150; 160; 200; 250; 315

Accessories

Silencers	Filter boxes	Electric heaters	Water heaters	Backdraft air dampers	Air dampers	Clamps	Speed controllers
SD	KFBK / KFBT	EKH	WKH	VRV	VK	K	CDT E/0-10

Overall dimensions [mm]

Type	Ø D	B	B1	H	L	Weight [kg]
Iso-Mix EC 100	98	243	283	234	505	4.6
Iso-Mix EC 125	123	243	283	234	474	4.6
Iso-Mix EC 150	147	273	314	264	579	6.1
Iso-Mix EC 160	157	273	314	264	579	6.3
Iso-Mix EC 200	198	343	393	296	558	8.0
Iso-Mix EC 250	248	402	452	363	664	15.0
Iso-Mix EC 315	313	478	528	455	785	25.0

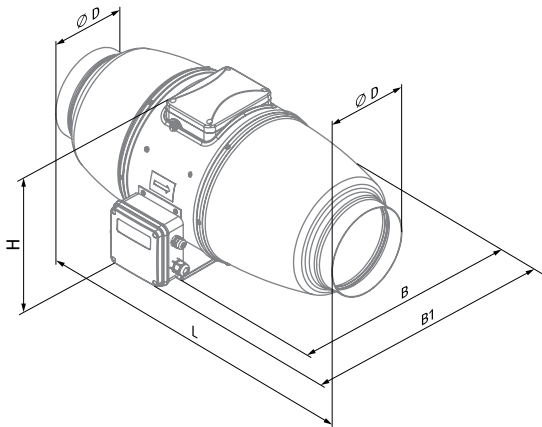

Iso-Mix EC 100 – Iso-Mix EC 160,
Iso-Mix EC 315

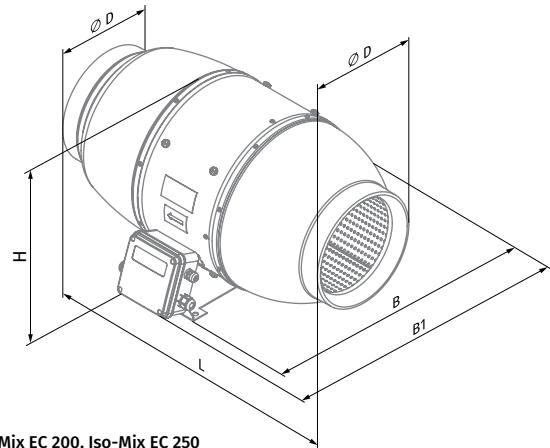

Iso-Mix EC 200, Iso-Mix EC 250

Technical data

Parameters	Iso-Mix EC 100	Iso-Mix EC 125	Iso-Mix EC 150 (160)	Iso-Mix EC 200	Iso-Mix EC 250	Iso-Mix EC 315
Voltage [V / 50 Hz]	1 ~ 230	1 ~ 230	1 ~ 230	1 ~ 230	1 ~ 230	1 ~ 230
Power [W]	30	40	55	123	169	284
Current [A]	0.29	0.37	0.48	1.02	1.38	1.25
Maximum air flow [m ³ /h (l/s)]	300 (83)	450 (125)	600 (167)	1040 (289)	1285 (357)	1970 (547)
RPM [min ⁻¹]	3680	3750	3390	3390	2870	2826
Sound pressure at 3 m [dBA]	37	43	38	43	42	46
Transported air temperature [°C]	-25...+55	-25...+55	-25...+55	-25...+55	-25...+55	-25...+55
IP rating	IPX4	IPX4	IPX4	IPX4	IPX4	IPX4
SEC class	B	B	B	-	-	-
ErP	2018	2018	2018	2018	2018	2018

ISO-MIX EC 100

Sound power level, A-weighted	Total	Octave frequency bands [Hz]								LpA 3 m	LpA 1 m
		63	125	250	500	1000	2000	4000	8000		
LWA to inlet [dBA]	62	46	59	59	42	37	34	31	23	42	52
LWA to outlet [dBA]	57	46	57	45	42	38	31	26	20	37	47
LWA to environment [dBA]	57	39	45	51	55	43	42	32	23	37	47

ISO-MIX EC 125

Sound power level, A-weighted	Total	Octave frequency bands [Hz]								LpA 3 m	LpA 1 m
		63	125	250	500	1000	2000	4000	8000		
LWA to inlet [dBA]	68	51	65	65	46	41	38	34	25	48	58
LWA to outlet [dBA]	65	52	65	51	48	43	35	30	23	45	55
LWA to environment [dBA]	63	50	53	57	61	50	49	38	29	43	53

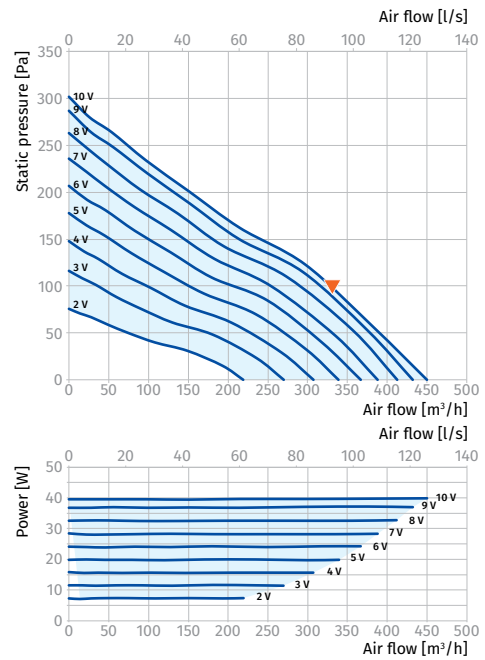
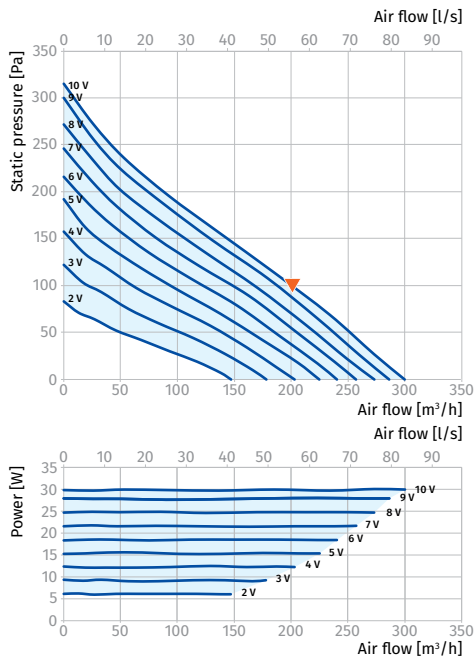

SOUND-INSULATED IN-LINE FANS

ISO-MIX EC 150 (160)

Sound power level, A-weighted ▼	Total	Octave frequency bands [Hz]								LpA 3 m	LpA 1 m
		63	125	250	500	1000	2000	4000	8000		
LWA to inlet [dBA]	61	45	58	58	41	37	33	30	23	41	51
LWA to outlet [dBA]	58	47	58	46	43	39	32	27	20	38	48
LWA to environment [dBA]	58	48	48	50	57	45	43	36	30	38	48

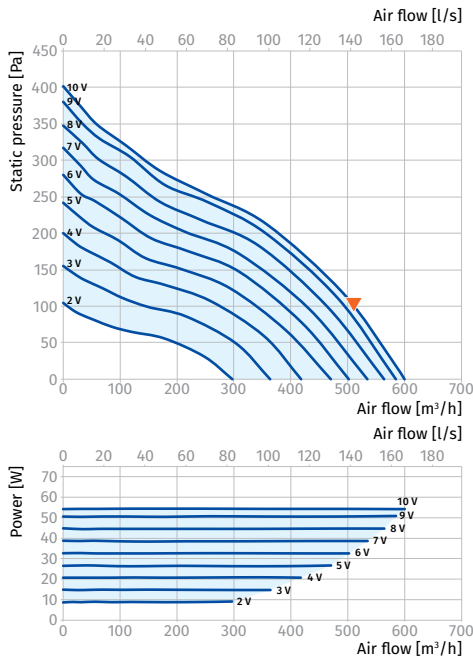

ISO-MIX EC 200

Sound power level, A-weighted ▼	Total	Octave frequency bands [Hz]								LpA 3 m	LpA 1 m
		63	125	250	500	1000	2000	4000	8000		
LWA to inlet [dBA]	68	37	47	57	63	63	62	61	55	48	58
LWA to outlet [dBA]	70	42	50	59	64	66	64	63	58	50	60
LWA to environment [dBA]	63	31	43	53	61	56	53	47	37	43	52

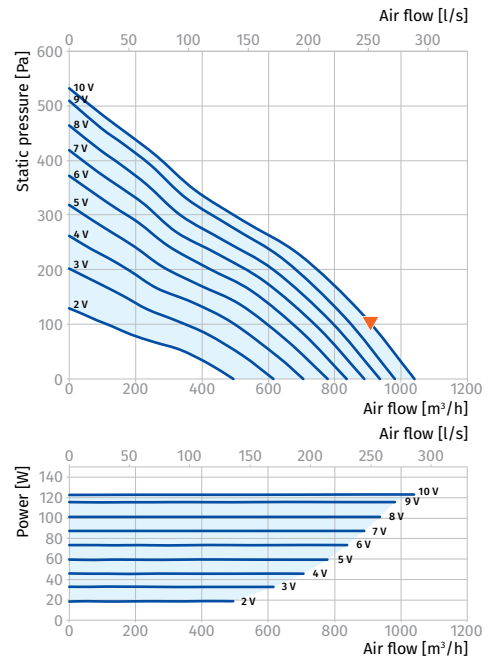

ISO-MIX EC 250

Sound power level, A-weighted ▼	Total	Octave frequency bands [Hz]								LpA 3 m	LpA 1 m
		63	125	250	500	1000	2000	4000	8000		
LWA to inlet [dBA]	70	45	48	60	66	65	63	58	52	50	60
LWA to outlet [dBA]	74	46	54	62	70	69	66	63	56	54	64
LWA to environment [dBA]	63	40	45	52	60	57	51	43	31	42	52

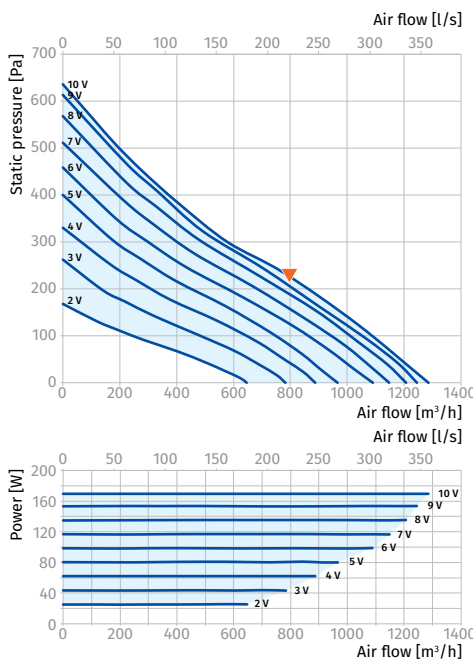

ISO-MIX EC 315

Sound power level, A-weighted ▼	Total	Octave frequency bands [Hz]								LpA 3 m	LpA 1 m
		63	125	250	500	1000	2000	4000	8000		
LWA to inlet [dBA]	72	41	55	64	65	70	65	63	55	52	62
LWA to outlet [dBA]	77	52	61	67	74	71	69	67	62	57	66
LWA to environment [dBA]	66	33	48	58	60	63	57	50	38	46	55

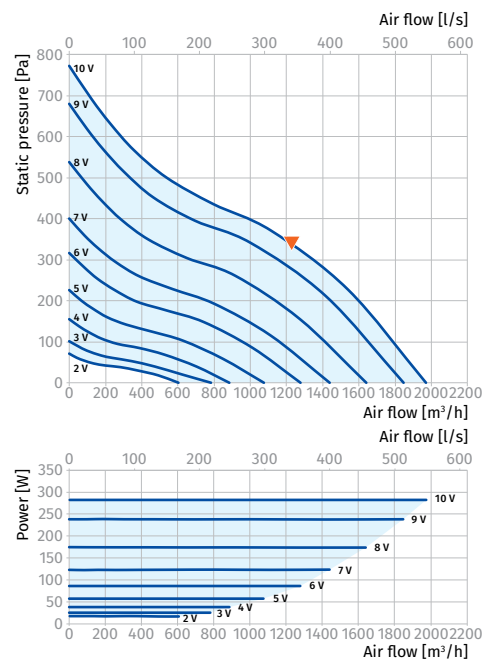

SOUND-INSULATED INLINE FANS

Iso Box-R (V2)

Sound-insulated inline centrifugal fans

Use

- Supply ventilation systems installed in premises with high requirements to clean air and the noise level.
- Suitable for limited mounting space.
- Compatible with Ø 100 up to 200 mm round air ducts.



Air flow:
up to 600 m³/h
167 l/s



Power:
from 36 W



Noise level:
from 14 dBA



Design

- The casing is made of polymer-coated steel, internally filled with sound-insulating layer.
- Internal airtight terminal box for power supply.

Motor

- Iso Box-R** series: four-pole asynchronous motor with external rotor and centrifugal impeller with forward curved blades.
- Iso Box-R V2** series: two-speed asynchronous motor with external rotor and centrifugal impeller with forward curved blades.
- Equipped with ball bearings for longer service life.
- Integrated thermal protection with automatic restart.
- Dynamically balanced impeller.

Speed control

- Iso Box-R** series: Smooth speed control with an external **CDT E1.8** thyristor controller (available upon separate order).
- Iso Box-R V2** series: Two-speed control with the external **CDP-2/10** speed switch (available upon separate order).

Mounting

- Due to compact design is the ideal solution for mounting in limited spaces, including the space behind false ceiling.
- Any mounting position.
- Wall or ceiling mounting with fixing brackets supplied as a standard.

SOUND-INSULATED INLINE FANS

Designation key

Series	Duct diameter [mm]	Motor modification	Speed
Iso Box-R	100; 150; 200	_: standard type L: low-powered motor	_: one speed V2: two-speed

Overall dimensions [mm]

Type	Ø D	L	H	B	L1	B1	L2	B2	K	K1
Iso Box-R 100 (V2)	100	415	250	335	515	428	360	378	70	97
Iso Box-R 150 (V2)	150	450	300	395	550	488	395	438	70	127
Iso Box-R 150 L (V2)	150	415	250	335	515	428	360	378	70	97
Iso Box-R 200 (V2)	200	450	300	395	550	488	395	438	70	127

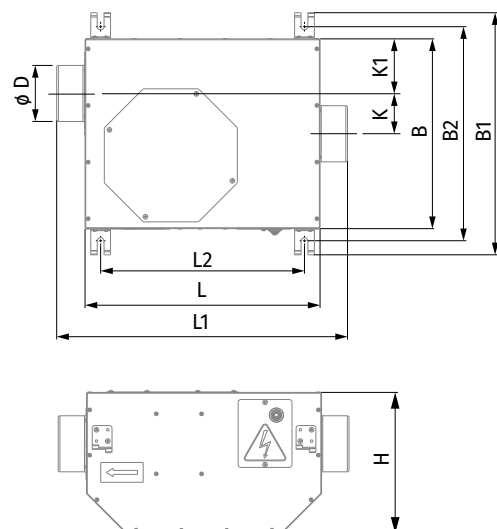

Accessories

Air disc valves	Duct system	Flexible air ducts	Grilles and hoods	Speed controllers	Clamps
VPR / VSR / VMR	BlauPlast	BlauFlex	Decor / GM	CDT E1.8 / CDP-2/10	K / KZ

Technical data

Parameters	Iso Box-R 100	Iso Box-R 150	Iso Box-R 150 L	Iso Box-R 200
Voltage [V]	1 ~ 230	1 ~ 230	1 ~ 230	1 ~ 230
Frequency [Hz]	50/60	50/60	50/60	50/60
Power [W]	61	103	75	130
Current [A]	0.27	0.48	0.33	0.58
Maximum air flow [m³/h (l/s)]	180 (50)	450 (125)	300 (83)	600 (167)
RPM [min⁻¹]	1200	1200	1200	1200
Sound pressure at 3 m [dBA]	23	27	25	38
Transported air temperature [°C]	-25..+40	-25..+40	-25..+40	-25..+40
IP rating	IPX4	IPX4	IPX4	IPX4
SEC class	D	C	C	C
ErP	2018	2018	2018	2018

ISO BOX-R 100

Sound power level, A-weighted	Total	Octave frequency bands [Hz]								LpA 3 m	LpA 1 m
		63	125	250	500	1000	2000	4000	8000		
LWA to inlet [dBA]	48	32	34	40	42	43	40	34	26	27	37
LWA to outlet [dBA]	51	27	42	47	45	44	32	24	13	30	40
LWA to environment [dBA]	43	31	34	35	38	36	34	31	26	23	33

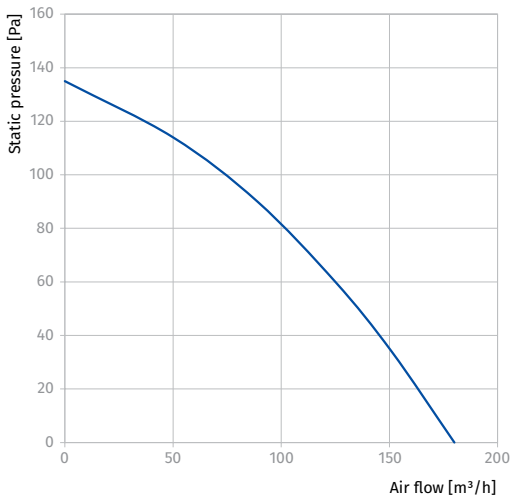

ISO BOX-R 150

Sound power level, A-weighted	Total	Octave frequency bands [Hz]								LpA 3 m	LpA 1 m
		63	125	250	500	1000	2000	4000	8000		
LWA to inlet [dBA]	53	39	40	47	50	41	40	38	27	33	43
LWA to outlet [dBA]	58	42	39	47	54	50	51	45	35	37	47
LWA to environment [dBA]	48	38	40	41	44	36	29	28	24	27	37

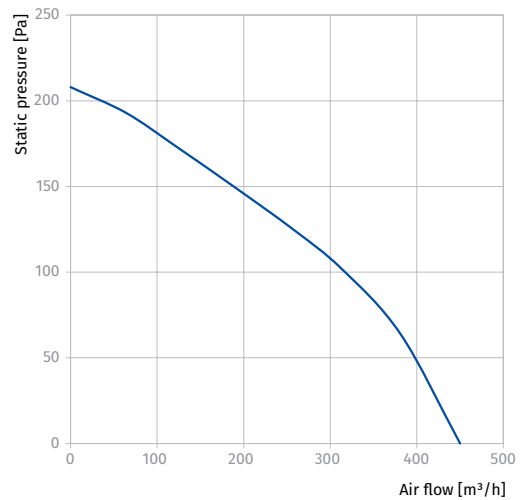

ISO BOX-R 150 L

Sound power level, A-weighted	Total	Octave frequency bands [Hz]								LpA 3 m	LpA 1 m
		63	125	250	500	1000	2000	4000	8000		
LWA to inlet [dBA]	53	28	44	49	47	46	34	25	14	33	43
LWA to outlet [dBA]	56	39	41	48	51	52	48	41	32	36	46
LWA to environment [dBA]	45	26	35	41	39	37	34	30	23	25	35

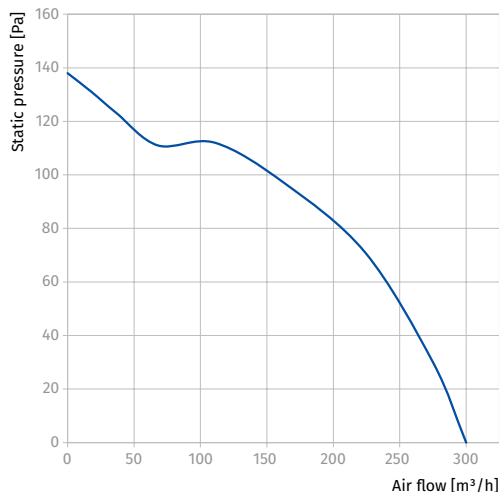

ISO BOX-R 200

Sound power level, A-weighted	Total	Octave frequency bands [Hz]								LpA 3 m	LpA 1 m
		63	125	250	500	1000	2000	4000	8000		
LWA to inlet [dBA]	67	55	56	58	60	58	59	57	55	46	56
LWA to outlet [dBA]	71	58	56	68	63	61	59	55	47	50	60
LWA to environment [dBA]	58	44	48	54	55	40	34	30	36	38	48

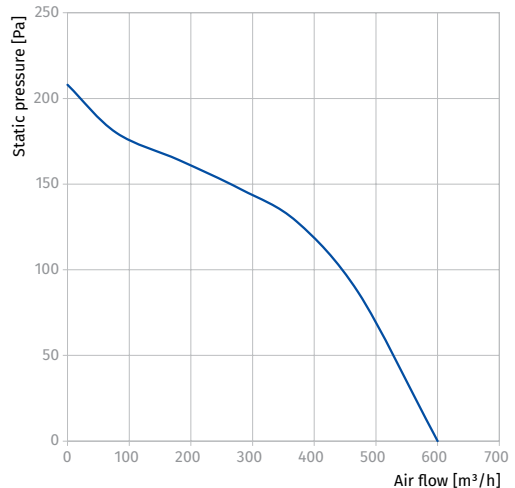

Parameters	Iso Box-R 100 V2		Iso Box-R 150 V2	
Speed	min	max	min	max
Voltage [V]	1 ~ 230		1 ~ 230	
Frequency [Hz]	50/60		50/60	
Power [W]	36	43	92	119
Current [A]	0.15	0.2	0.4	0.55
Maximum air flow [m ³ /h (l/s)]	170 (47)	200 (56)	350 (97)	450 (125)
RPM [min ⁻¹]	700	1200	700	1200
Sound pressure at 3 m [dBA]	14	23	16	27
Transported air temperature [°C]	-25..+40		-25..+40	
IP rating	IPX4		IPX4	
SEC class	D		D	
ErP	2018		2018	

ISO BOX-R 100 V2

	Sound power level, A-weighted	Total	Octave frequency bands [Hz]								LpA 3 m	LpA 1 m
			63	125	250	500	1000	2000	4000	8000		
min	LWA to inlet [dBA]	41	26	28	33	35	36	33	28	22	20	30
	LWA to outlet [dBA]	43	22	35	39	37	37	27	20	11	23	33
	LWA to environment [dBA]	35	23	26	26	29	27	26	23	20	14	24
max	LWA to inlet [dBA]	48	32	34	40	42	43	40	34	26	27	37
	LWA to outlet [dBA]	51	27	42	47	45	44	32	24	13	30	40
	LWA to environment [dBA]	43	31	34	35	38	36	34	31	26	23	33

ISO BOX-R 150 V2

	Sound power level, A-weighted	Total	Octave frequency bands [Hz]								LpA 3 m	LpA 1 m
			63	125	250	500	1000	2000	4000	8000		
min	LWA to inlet [dBA]	44	31	32	38	41	33	32	31	22	24	34
	LWA to outlet [dBA]	48	34	32	38	44	41	41	36	28	28	38
	LWA to environment [dBA]	36	27	29	30	32	26	21	20	17	16	26
max	LWA to inlet [dBA]	53	39	40	47	50	41	40	38	27	33	43
	LWA to outlet [dBA]	58	42	39	47	54	50	51	45	35	37	47
	LWA to environment [dBA]	48	38	40	41	44	36	29	28	24	27	37

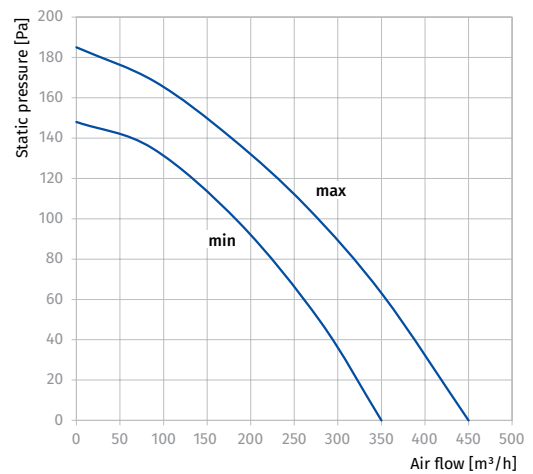
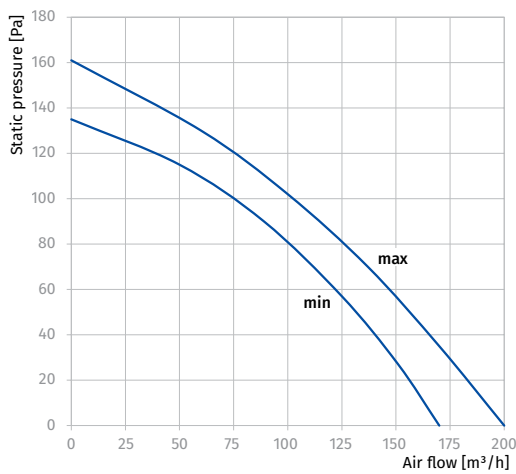

Parameters	Iso Box-R 150 L V2		Iso Box-R 200 V2	
	min	max	min	max
Speed				
Voltage [V]	1 ~ 230		1 ~ 230	
Frequency [Hz]	50/60		50/60	
Power [W]	46	54	107	137
Current [A]	0.2	0.25	0.47	0.62
Maximum air flow [m³/h (l/s)]	220 (61)	360 (100)	370 (103)	600 (167)
RPM [min⁻¹]	700	1200	700	1200
Sound pressure at 3 m [dBA]	15	25	22	38
Transported air temperature [°C]	-25..+40		-25..+40	
IP rating	IPX4		IPX4	
SEC class	C		C	
ErP	2018		2018	

ISO BOX-R 150 L V2

Sound power level, A-weighted	Total	Octave frequency bands [Hz]								LpA 3 m	LpA 1 m
		63	125	250	500	1000	2000	4000	8000		
min LWA to inlet [dBA]	45	24	37	41	39	38	28	21	11	25	35
LWA to outlet [dBA]	48	32	34	40	42	43	40	34	26	27	37
LWA to environment [dBA]	36	20	26	31	29	28	26	23	17	15	25
max LWA to inlet [dBA]	53	28	44	49	47	46	34	25	14	33	43
LWA to outlet [dBA]	56	39	41	48	51	52	48	41	32	36	46
LWA to environment [dBA]	45	26	35	41	39	37	34	30	23	25	35

ISO BOX-R 200 V2

Sound power level, A-weighted	Total	Octave frequency bands [Hz]								LpA 3 m	LpA 1 m
		63	125	250	500	1000	2000	4000	8000		
min LWA to inlet [dBA]	55	44	45	47	48	47	48	46	44	35	45
LWA to outlet [dBA]	58	46	45	54	51	49	47	44	38	37	47
LWA to environment [dBA]	43	31	34	38	39	28	24	21	25	22	32
max LWA to inlet [dBA]	67	55	56	58	60	58	59	57	55	46	56
LWA to outlet [dBA]	71	58	56	68	63	61	59	55	47	50	60
LWA to environment [dBA]	58	44	48	54	55	40	34	30	36	38	48

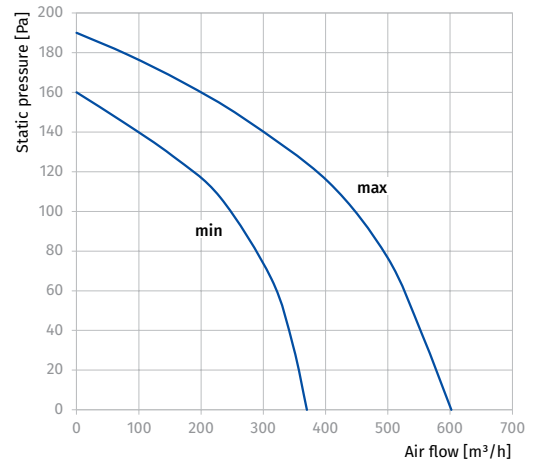
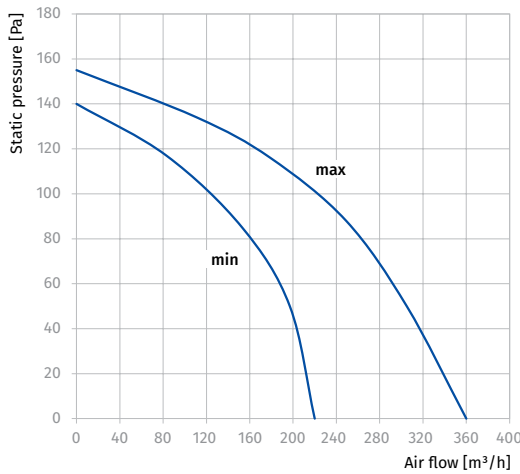

Iso Box-F (V2)

Sound-insulated inline centrifugal fans with filters

Use

- Supply ventilation systems installed in premises with high requirements to clean air and the noise level.
- Suitable for limited mounting space.
- Compatible with Ø 100 up to 200 mm round air ducts.



Air flow:
up to 630 m³/h
175 l/s



Power:
from 32 W



Noise level:
from 14 dBA



Design

- The casing is made of polymer-coated steel, internally filled with sound-insulating layer.
- Internal airtight terminal box for power supply.
- Easy access for filter maintenance.

Motors

- Iso Box-F** series: four-pole asynchronous motor with external rotor and centrifugal impeller with forward curved blades.
- Iso Box-F V2** series: two-speed asynchronous motor with external rotor and centrifugal impeller with forward curved blades.
- Equipped with ball bearings for longer service life.
- Integrated thermal protection with automatic restart.
- Dynamically balanced impeller.

Speed control

- Iso Box-F** series: Smooth speed control with an external **CDT E1.8** thyristor controller (available upon separate order).
- Iso Box-F V2** series: Two-speed control with the external **CDP-2/10** speed switch (available upon separate order).

Mounting

- Due to compact design is the ideal solution for mounting in limited spaces, including the space behind false ceiling.
- Any mounting position.
- Wall or ceiling mounting with fixing brackets supplied as a standard.

Air filtration

- Built-in filters provide efficient air filtration. Up to three filters can be installed into the fan.
- G4** filter provides primary filtration. At the second stage, the secondary filter **F8** or **HEPA filter H13** can be installed. **F8** filter arrests up to 98 % of PM2.5 dust particles. **H13** filter arrest up to 99 % of PM2.5 dust particles, pollen and bacteria. For additional removal of odors and gases carbon filter can be installed.
- Quick access to replaceable filters through service panel.

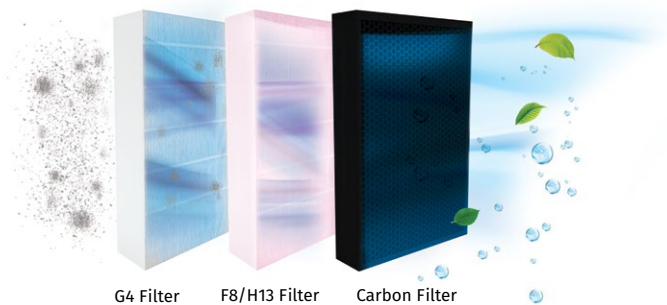

G4 Filter F8/H13 Filter Carbon Filter

Designation key

Series	Duct diameter [mm]	Filters	Motor modification	Speed
Iso Box-F	100; 150; 200	G4; G4-F8; G4-F8-Carbon; G4-H13; G4-H13-Carbon	_: standard model L: low-powered motor	_: one speed V2: two-speed

Accessories

Air disc valves	Duct system	Flexible air ducts	Grilles and hoods	Speed controllers	Clamps
VPR / VSR / VMR	BlauPlast	BlauFlex	Decor / GM	CDT E1.8 / CDP-2/10	K / KZ

Replaceable filters

		Iso Box-F 100 (V2)	Iso Box-F 150 (V2)	Iso Box-F 150 L (V2)	Iso Box-F 200 (V2)
G4 Panel filter		FP 220x400x47 G4	FP 270x425x47 G4	FP 220x400x47 G4	FP 270x590x47 G4
F8 Panel filter		FP 220x400x47 F8	FP 270x425x47 F8	FP 220x400x47 F8	FP 270x590x47 F8
H13 Panel filter		FP 220x400x47 H13	FP 270x425x47 H13	FP 220x400x47 H13	FP 270x590x47 H13
Carbon panel filter		FP 220x400x47 C	FP 270x425x47 C	FP 220x400x47 C	FP 270x590x47 C

Overall dimensions [mm]

Model	Ø D	L	H	B	L1	B1	L2	B2	Weight [kg]
Iso Box-F 100 G4 (V2)	100	705	250	415	805	508	650	458	13.95
Iso Box-F 100 G4-F8 (V2)	100	705	250	415	805	508	650	458	14.16
Iso Box-F 100 G4-F8-Carbon (V2)	100	705	250	415	805	508	650	458	14.86
Iso Box-F 100 G4-H13 (V2)	100	705	250	415	805	508	650	458	14.16
Iso Box-F 100 G4-H13-Carbon (V2)	100	705	250	415	805	508	650	458	14.86
Iso Box-F 150 G4 (V2)	150	735	300	440	835	533	680	483	15.92
Iso Box-F 150 G4-F8 (V2)	150	735	300	440	835	533	680	483	16.17
Iso Box-F 150 G4-F8-Carbon (V2)	150	735	300	440	835	533	680	483	17.08
Iso Box-F 150 G4-H13 (V2)	150	735	300	440	835	533	680	483	16.17
Iso Box-F 150 G4-H13-Carbon (V2)	150	735	300	440	835	533	680	483	17.08
Iso Box-F 150 G4 L (V2)	150	705	250	415	805	508	650	458	13.96
Iso Box-F 150 G4-F8 L (V2)	150	705	250	415	805	508	650	458	14.17
Iso Box-F 150 G4-F8-Carbon L (V2)	150	705	250	415	805	508	650	458	14.87
Iso Box-F 150 G4-H13 L (V2)	150	705	250	415	805	508	650	458	14.17
Iso Box-F 150 G4-H13-Carbon L (V2)	150	705	250	415	805	508	650	458	14.87
Iso Box-F 200 G4 (V2)	200	735	300	605	835	698	680	648	18.72
Iso Box-F 200 G4-F8 (V2)	200	735	300	605	835	698	680	648	19.10
Iso Box-F 200 G4-F8-Carbon (V2)	200	735	300	605	835	698	680	648	20.32
Iso Box-F 200 G4-H13 (V2)	200	735	300	605	835	698	680	648	19.10
Iso Box-F 200 G4-H13-Carbon (V2)	200	735	300	605	835	698	680	648	20.32

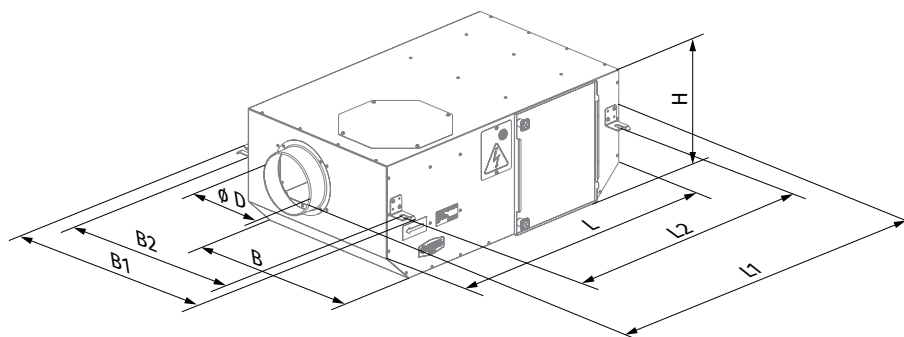

Technical data

Parameters	Iso Box-F 100 G4 Iso Box-F 100 G4-Carbon	Iso Box-F 100 G4-F8 Iso Box-F 100 G4-F8-Carbon	Iso Box-F 100 G4-H13 Iso Box-F 100 G4-H13-Carbon
Voltage [V]	1 ~ 230	1 ~ 230	1 ~ 230
Frequency [Hz]	50/60	50/60	50/60
Power [W]	53	53	52
Current [A]	0.27	0.27	0.27
Maximum air flow [m ³ /h (l/s)]	190 (53)	180 (50)	170 (47)
RPM [min ⁻¹]	1300	1300	1300
Sound pressure at 3 m [dBA]	23	23	23
Transported air temperature [°C]	-25...+40	-25...+40	-25...+40
IP rating	IPX4	IPX4	IPX4
PM2.5 Ratio [%]	36	93	98
SEC class	D	D	D
ErP	2018	2018	2018

ISO BOX-F 100

Sound power level, A-weighted	Total	Octave frequency bands [Hz]								LpA 3 m	LpA 1 m
		63	125	250	500	1000	2000	4000	8000		
L _{WA} to inlet [dBA]	48	32	34	40	42	43	40	34	26	27	37
L _{WA} to outlet [dBA]	51	27	42	47	45	44	32	24	13	30	40
L _{WA} to environment [dBA]	43	31	34	35	38	36	34	31	26	23	33

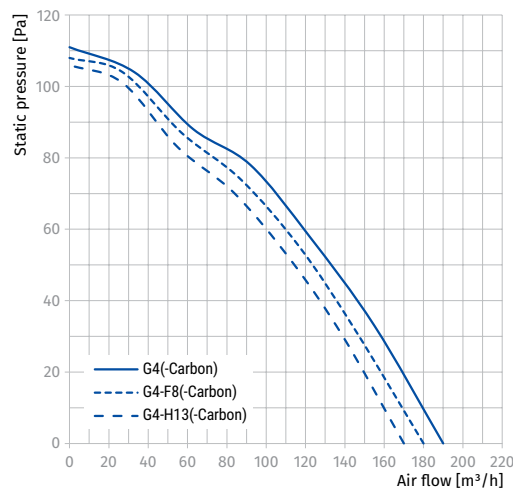

Parameters	Iso Box-F 150 G4 L Iso Box-F 150 G4-Carbon L	Iso Box-F 150 G4-F8 L Iso Box-F 150 G4-F8-Carbon L	Iso Box-F 150 G4-H13 L Iso Box-F 150 G4-H13-Carbon L
Voltage [V]	1 ~ 230	1 ~ 230	1 ~ 230
Frequency [Hz]	50/60	50/60	50/60
Power [W]	63	61	59
Current [A]	0.29	0.25	0.28
Maximum air flow [m³/h (l/s)]	360 (100)	330 (92)	310 (86)
RPM [min ⁻¹]	1300	1300	1300
Sound pressure at 3 m [dBA]	25	25	25
Transported air temperature [°C]	-25..+40	-25..+40	-25..+40
IP rating	IPX4	IPX4	IPX4
PM2.5 Ratio [%]	31	92	98
SEC class	C	C	C
ErP	-	-	2018

ISO BOX-F 150 L

Sound power level, A-weighted	Total	Octave frequency bands [Hz]								LpA 3 m	LpA 1 m
		63	125	250	500	1000	2000	4000	8000		
L _{WA} to inlet [dBA]	53	28	44	49	47	46	34	25	14	33	43
L _{WA} to outlet [dBA]	56	39	41	48	51	52	48	41	32	36	46
L _{WA} to environment [dBA]	45	26	35	41	39	37	34	30	23	25	35

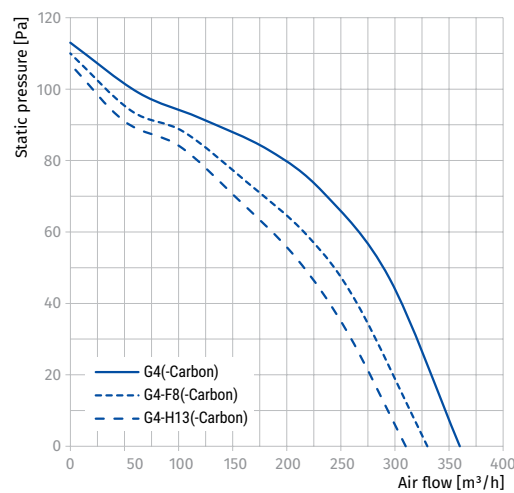

SOUND-INSULATED INLINE FANS

Parameters	Iso Box-F 150 G4 Iso Box-F 150 G4-Carbon	Iso Box-F 150 G4-F8 Iso Box-F 150 G4-F8-Carbon	Iso Box-F 150 G4-H13 Iso Box-F 150 G4-H13-Carbon
Voltage [V]	1 ~ 230	1 ~ 230	1 ~ 230
Frequency [Hz]	50/60	50/60	50/60
Power [W]	107	104	102
Current [A]	0.49	0.48	0.48
Maximum air flow [m ³ /h (l/s)]	440 (122)	400 (111)	360 (100)
RPM [min ⁻¹]	1250	1250	1250
Sound pressure at 3 m [dBA]	27	27	27
Transported air temperature [°C]	-25..+40	-25..+40	-25..+40
IP rating	IPX4	IPX4	IPX4
PM2.5 Ratio [%]	39	92	98
SEC class	C	C	D
ErP	2018	2018	2018

ISO BOX-F 150

Sound power level, A-weighted	Total	Octave frequency bands [Hz]								LpA 3 m	LpA 1 m
		63	125	250	500	1000	2000	4000	8000		
L _{WA} to inlet [dBA]	53	39	40	47	50	41	40	38	27	33	43
L _{WA} to outlet [dBA]	58	42	39	47	54	50	51	45	35	37	47
L _{WA} to environment [dBA]	48	38	40	41	44	36	29	28	24	27	37

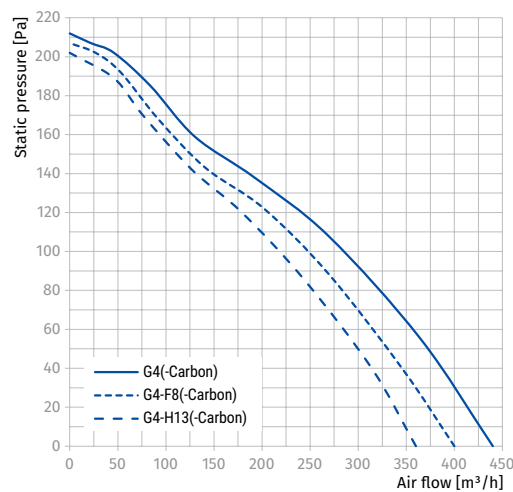

Parameters	Iso Box-F 200 G4 Iso Box-F 200 G4-Carbon	Iso Box-F 200 G4-F8 Iso Box-F 200 G4-F8-Carbon	Iso Box-F 200 G4-H13 Iso Box-F 200 G4-H13-Carbon
Voltage [V]	1 ~ 230	1 ~ 230	1 ~ 230
Frequency [Hz]	50/60	50/60	50/60
Power [W]	123	120	115
Current [A]	0.56	0.56	0.52
Maximum air flow [m³/h (l/s)]	580 (161)	570 (158)	490 (136)
RPM [min ⁻¹]	1250	1250	1250
Sound pressure at 3 m [dBA]	38	38	38
Transported air temperature [°C]	-25..+40	-25..+40	-25..+40
IP rating	IPX4	IPX4	IPX4
PM2.5 Ratio [%]	40	93	98
SEC class	C	C	C
ErP	2018	2018	2018

ISO BOX-F 200

Sound power level, A-weighted	Total	Octave frequency bands [Hz]								LpA 3 m	LpA 1 m
		63	125	250	500	1000	2000	4000	8000		
L _{WA} to inlet [dBA]	67	55	56	58	60	58	59	57	55	46	56
L _{WA} to outlet [dBA]	71	58	56	68	63	61	59	55	47	50	60
L _{WA} to environment [dBA]	58	44	48	54	55	40	34	30	36	38	48

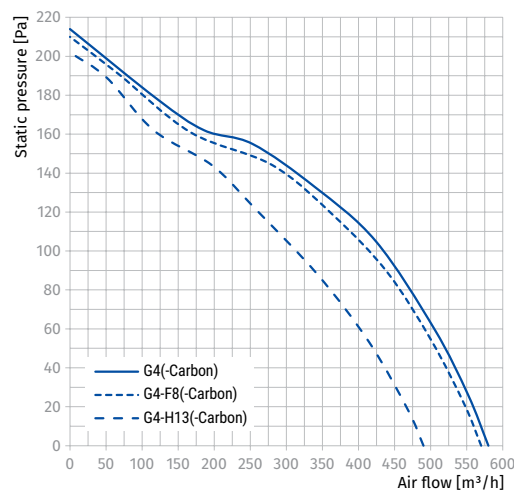

SOUND-INSULATED INLINE FANS

Parameters	Iso Box-F 100 G4 V2 Iso Box-F 100 G4-Carbon V2		Iso Box-F 100 G4-F8 V2 Iso Box-F 100 G4-F8-Carbon V2		Iso Box-F 100 G4-H13 V2 Iso Box-F 100 G4-H13-Carbon V2	
	min	max	min	max	min	max
Speed						
Voltage [V]	1 ~ 230		1 ~ 230		1 ~ 230	
Frequency [Hz]	50		50		50	
Power [W]	34	42	33	41	32	41
Current [A]	0.15	0.19	0.15	0.19	0.15	0.19
Maximum air flow [m³/h (l/s)]	160 (44)	190 (53)	150 (42)	175 (49)	140 (39)	160 (44)
RPM [min ⁻¹]	700	1200	700	1200	700	1200
Sound pressure at 3 m [dBA]	14	23	14	23	14	23
Transported air temperature [°C]	-25..+40		-25..+40		-25..+40	
IP rating	IPX4		IPX4		IPX4	
PM2.5 Ratio [%]	35	31	94	93	99	98
SEC class	D		E		E	
ErP	2018		-		-	

ISO BOX-F 100 V2

Sound power level, A-weighted	Total	Octave frequency bands [Hz]								LpA 3 m	LpA 1 m	
		63	125	250	500	1000	2000	4000	8000			
min	L _{WA} to inlet [dBA]	41	26	28	33	35	36	33	28	22	20	30
	L _{WA} to outlet [dBA]	43	22	35	39	37	37	27	20	11	23	33
	L _{WA} to environment [dBA]	35	23	26	26	29	27	26	23	20	14	24
max	L _{WA} to inlet [dBA]	48	32	34	40	42	43	40	34	26	27	37
	L _{WA} to outlet [dBA]	51	27	42	47	45	44	32	24	13	30	40
	L _{WA} to environment [dBA]	43	31	34	35	38	36	34	31	26	23	33

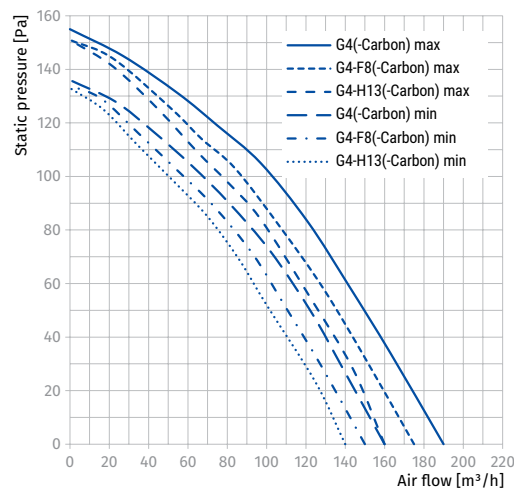

Parameters	Iso Box-F 150 G4 L V2 Iso Box-F 150 G4-Carbon L V2		Iso Box-F 150 G4-F8 L V2 Iso Box-F 150 G4-F8-Carbon L V2		Iso Box-F 150 G4-H13 L V2 Iso Box-F 150 G4-H13-Carbon L V2	
	min	max	min	max	min	max
Speed						
Voltage [V]	1 ~ 230		1 ~ 230		1 ~ 230	
Frequency [Hz]	50		50		50	
Power [W]	44	52	41	50	40	48
Current [A]	0.19	0.23	0.18	0.22	0.18	0.21
Maximum air flow [m³/h (l/s)]	230 (64)	340 (94)	215 (60)	310 (86)	205 (57)	285 (79)
RPM [min ⁻¹]	700	1200	700	1200	700	1200
Sound pressure at 3 m [dBA]	15	25	15	25	15	25
Transported air temperature [°C]	-25..+40		-25..+40		-25..+40	
IP rating	IPX4		IPX4		IPX4	
PM2.5 Ratio [%]	31	23	90	87	93	92
SEC class	C		C		D	
ErP	2018		2018		2018	

ISO BOX-F 150 L V2

Sound power level, A-weighted	Total	Octave frequency bands [Hz]								LpA 3 m	LpA 1 m	
		63	125	250	500	1000	2000	4000	8000			
min	LWA to inlet [dBA]	45	24	37	41	39	38	28	21	11	25	35
	LWA to outlet [dBA]	48	32	34	40	42	43	40	34	26	27	37
	LWA to environment [dBA]	36	20	26	31	29	28	26	23	17	15	25
max	LWA to inlet [dBA]	53	28	44	49	47	46	34	25	14	33	43
	LWA to outlet [dBA]	56	39	41	48	51	52	48	41	32	36	46
	LWA to environment [dBA]	45	26	35	41	39	37	34	30	23	25	35

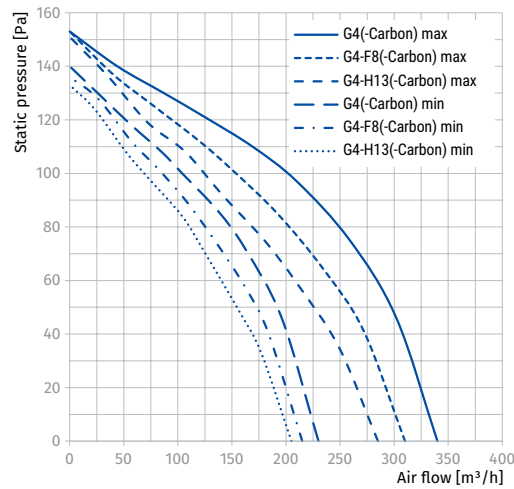

Parameters	Iso Box-F 150 G4 V2 Iso Box-F 150 G4-Carbon V2		Iso Box-F 150 G4-F8 V2 Iso Box-F 150 G4-F8-Carbon V2		Iso Box-F 150 G4-H13 V2 Iso Box-F 150 G4-H13-Carbon V2	
	min	max	min	max	min	max
Speed						
Voltage [V]	1 ~ 230		1 ~ 230		1 ~ 230	
Frequency [Hz]	50		50		50	
Power [W]	92	117	89	115	85	114
Current [A]	0.41	0.55	0.41	0.55	0.38	0.54
Maximum air flow [m³/h (l/s)]	320 (89)	430 (119)	300 (83)	390 (108)	280 (78)	355 (99)
RPM [min ⁻¹]	700	1200	700	1200	700	1200
Sound pressure at 3 m [dBA]	16	27	16	27	16	27
Transported air temperature [°C]	-25...+40		-25...+40		-25...+40	
IP rating	IPX4		IPX4		IPX4	
PM2.5 Ratio [%]	47	41	95	94	98	96
SEC class	D		C		E	
ErP	2018		2018		-	

ISO BOX-F 150 V2

Sound power level, A-weighted	Total	Octave frequency bands [Hz]								LpA 3 m	LpA 1 m	
		63	125	250	500	1000	2000	4000	8000			
min	L _{WA} to inlet [dBA]	44	31	32	38	41	33	32	31	22	24	34
	L _{WA} to outlet [dBA]	48	34	32	38	44	41	41	36	28	28	38
	L _{WA} to environment [dBA]	36	27	29	30	32	26	21	20	17	16	26
max	L _{WA} to inlet [dBA]	53	39	40	47	50	41	40	38	27	33	43
	L _{WA} to outlet [dBA]	58	42	39	47	54	50	51	45	35	37	47
	L _{WA} to environment [dBA]	48	38	40	41	44	36	29	28	24	27	37

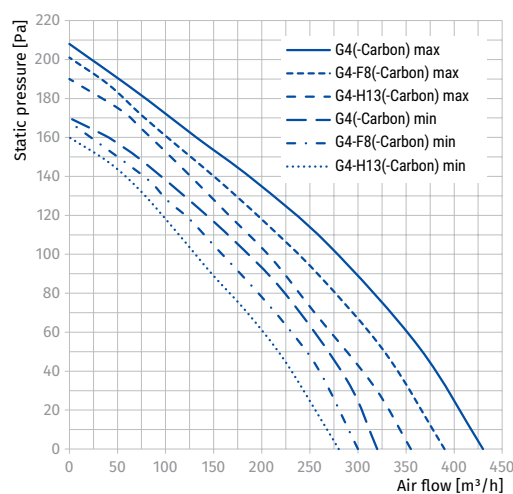

Parameters	Iso Box-F 200 G4 V2 Iso Box-F 200 G4-Carbon V2		Iso Box-F 200 G4-F8 V2 Iso Box-F 200 G4-F8-Carbon V2		Iso Box-F 200 G4-H13 V2 Iso Box-F 200 G4-H13-Carbon V2	
	min	max	min	max	min	max
Speed						
Voltage [V]	1 ~ 230		1 ~ 230		1 ~ 230	
Frequency [Hz]	50		50		50	
Power [W]	106	123	103	121	97	119
Current [A]	0.47	0.59	0.45	0.57	0.43	0.55
Maximum air flow [m³/h (l/s)]	390 (108)	630 (175)	380 (106)	590 (164)	350 (97)	525 (146)
RPM [min ⁻¹]	700	1200	700	1200	700	1200
Sound pressure at 3 m [dBA]	22	38	22	38	22	38
Transported air temperature [°C]	-25..+40		-25..+40		-25..+40	
IP rating	IPX4		IPX4		IPX4	
PM2.5 Ratio [%]	37	28	98	97	99	98
SEC class	C		D		D	
ErP	2018		2018		2018	

ISO BOX-F 200 V2

Sound power level, A-weighted	Total	Octave frequency bands [Hz]								LpA 3 m	LpA 1 m	
		63	125	250	500	1000	2000	4000	8000			
min	LWA to inlet [dBA]	55	44	45	47	48	47	48	46	44	35	45
	LWA to outlet [dBA]	58	46	45	54	51	49	47	44	38	37	47
	LWA to environment [dBA]	43	31	34	38	39	28	24	21	25	22	32
max	LWA to inlet [dBA]	67	55	56	58	60	58	59	57	55	46	56
	LWA to outlet [dBA]	71	58	56	68	63	61	59	55	47	50	60
	LWA to environment [dBA]	58	44	48	54	55	40	34	30	36	38	48

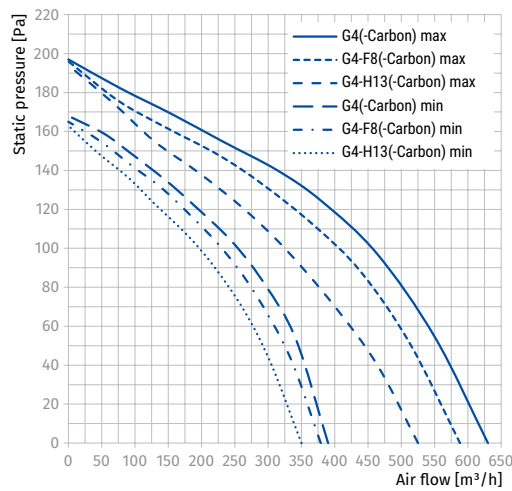

Iso Box-F ES (V2)

Sound-insulated inline centrifugal fans with electrostatic filters

Use

- Supply ventilation systems installed in premises with high requirements to clean air and the noise level.
- Suitable for limited mounting space.
- Compatible with Ø 100 up to 200 mm round air ducts.



Air flow:
up to 645 m³/h
179 l/s



Power:
from 34 W



Noise level:
from 14 dBA



Design

- The casing is made of polymer-coated steel, internally filled with sound-insulating layer.
- Internal airtight terminal box for power supply.
- Easy access for filter maintenance.

Motor

- Iso Box-F ES** series: four-pole asynchronous motor with external rotor and centrifugal impeller with forward curved blades.
- Iso Box-F ES V2** series: two-speed asynchronous motor with external rotor and centrifugal impeller with forward curved blades.
- Equipped with ball bearings for longer service life.
- Integrated thermal protection with automatic restart.
- Dynamically balanced turbine.

Speed control

- Iso Box-F ES** series: smooth speed control with an external **CDT E1.8** thyristor controller (available upon separate order).
- Iso Box-F ES V2** series: two-speed control with the external **CDP-2/10** speed switch (available upon separate order).

Mounting

- Due to compact design is the ideal solution for mounting in limited spaces, including the space behind false ceiling.
- Any mounting position.
- Wall or ceiling mounting with fixing brackets supplied as a standard.

Air filtration

- G4** filter provides primary filtration.
- Fine filtering with an electrostatic filter.
- Quick access to replaceable filters through service panel.

Electrostatic filter

- Electrostatic filter enables purification of air from fine dust and soot, spray, smoke and other particles with the size 0.01 microns and less.
- Max. filter cleaning efficiency 98 %.
- The electrostatic filters rely on gravity of oppositely charged objects.
- The polluted air stream flows through the spray charging unit for the particles ionization.
- Ionized particles are moved by the airstream and accumulated on the collecting plates which are oppositely charged.

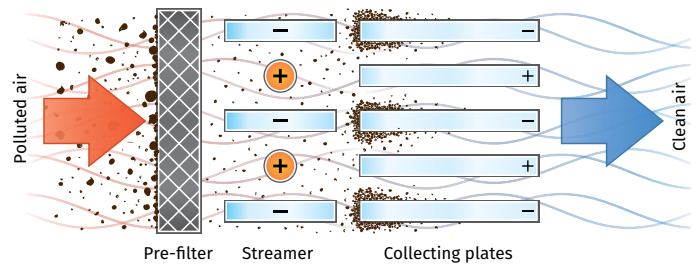

- The filter cleaning interval depends on the inlet air pollution density and may vary from 7 up to 21 days.
- The filter cleaning interval is determined by the visual inspection of the filters.
- Vacuum cleaning is allowed.

Designation key

Series	Duct diameter [mm]	Filters	Motor modification	Speed
Iso Box-F	100; 150; 200	ES: electrostatic filter	_: standard type L: low-powered motor	_: one speed V2: two-speed

Accessories

Air disc valves	Duct system	Flexible air ducts	Grilles and hoods	Speed controllers	Clamps
VPR / VSR / VMR	BlauPlast	BlauFlex	Decor / GM	CDT E1.8 / CDP-2/10	K / KZ

Replaceable filters

Model	Iso Box-F 100 ES	Iso Box-F 150 ES	Iso Box-F 150 ES L	Iso Box-F 200 ES	Iso Box-F 100 ES V2	Iso Box-F 150 ES V2	Iso Box-F 150 ES L V2	Iso Box-F 200 ES V2
G4 Panel filter	FP 220x400x47 G4	FP 270x425x47 G4	FP 220x400x47 G4	FP 270x590x47 G4	FP 220x400x47 G4	FP 270x425x47 G4	FP 220x400x47 G4	FP 270x590x47 G4

Overall dimensions [mm]

Type	Ø D	L	H	B	L1	B1	L2	B2	Weight [kg]
Iso Box-F 100 ES (V2)	100	755	250	458	855	551	700	502	16.5
Iso Box-F 150 ES L (V2)	150	755	250	458	855	551	700	502	16.5
Iso Box-F 150 ES (V2)	150	785	300	458	855	551	730	502	18.5
Iso Box-F 200 ES (V2)	200	785	300	658	855	751	730	702	20.5

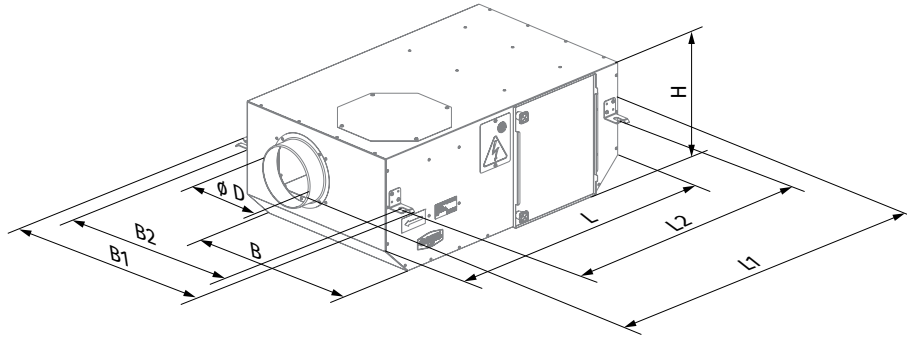

Technical data

Parameters	Iso Box-F 100 ES		Iso Box-F 150 ES L		Iso Box-F 150 ES		Iso Box-F 200 ES	
Voltage [V]	1 ~ 230		1 ~ 230		1 ~ 230		1 ~ 230	
Frequency [Hz]	50	60	50	60	50	60	50	60
Power [W]	53	55	68	78	112	131	135	157
Current [A]	0.27	0.24	0.3	0.34	0.51	0.57	0.59	0.68
Maximum air flow [m³/h (l/s)]	180 (50)	215 (60)	350 (97)	390 (108)	460 (128)	530 (147)	640 (178)	645 (179)
RPM [min ⁻¹]	1300	1480	1300	1475	1250	1430	1250	1315
Sound pressure at 3 m [dBA]	23	24	25	26	25	27	34	35
Transported air temperature [°C]	-25...+40		-25...+40		-25...+40		-25...+40	
Ingress protection rating	IPX4		IPX4		IPX4		IPX4	
PM2.5 Ratio [%]	97.1		97		95.6		97.4	
SEC class	D		C		C		C	
ErP	2018		2018		2018		2018	

ISO BOX-F 100 ES

Sound power level, A-weighted	Total	Octave frequency band [Hz]								LpA, 3 m	LpA, 1 m
		63	125	250	500	1000	2000	4000	8000		
L _{WA} to inlet [dBA]	48	32	34	40	42	43	40	34	26	27	37
L _{WA} to outlet [dBA]	51	27	42	47	45	44	32	24	13	30	40
L _{WA} to environment [dBA]	43	31	34	35	38	36	34	31	26	23	33

ISO BOX-F 150 ES L

Sound power level, A-weighted	Total	Octave frequency band [Hz]								LpA, 3 m	LpA, 1 m
		63	125	250	500	1000	2000	4000	8000		
L _{WA} to inlet [dBA]	53	28	44	49	47	46	34	25	14	33	43
L _{WA} to outlet [dBA]	56	39	41	48	51	52	48	41	32	36	46
L _{WA} to environment [dBA]	45	26	35	41	39	37	34	30	23	25	35

SOUND-INSULATED INLINE FANS

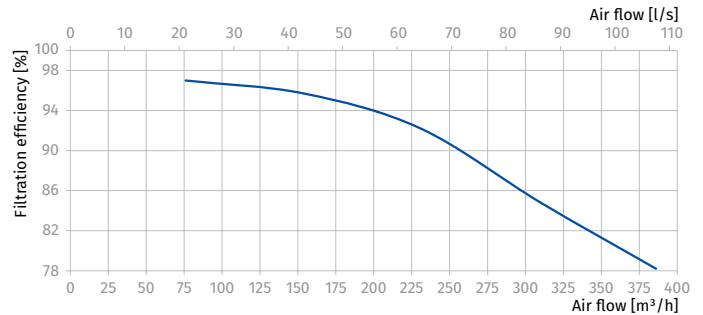
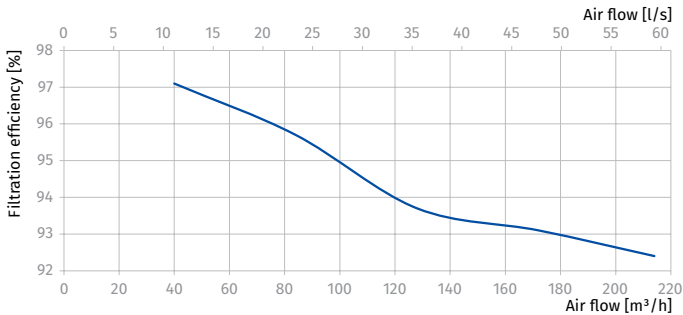
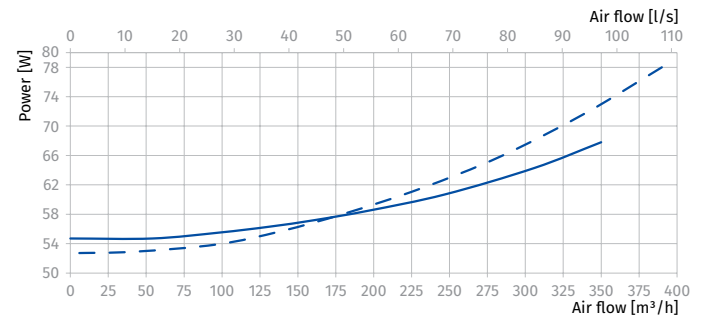
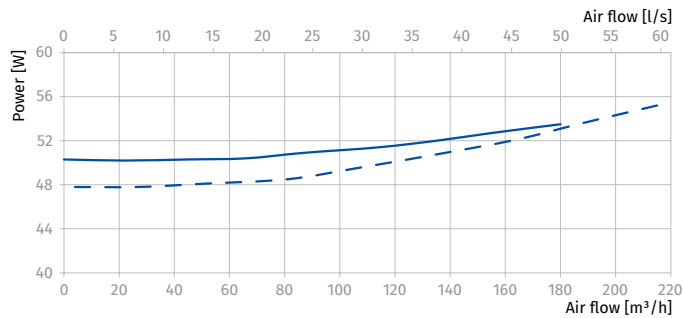
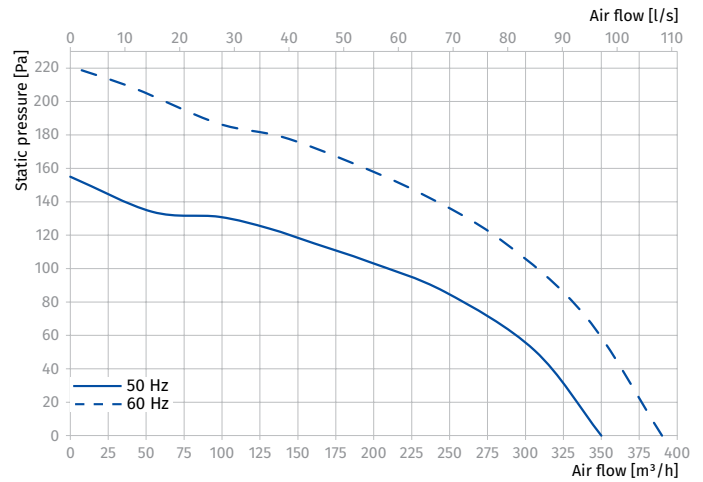
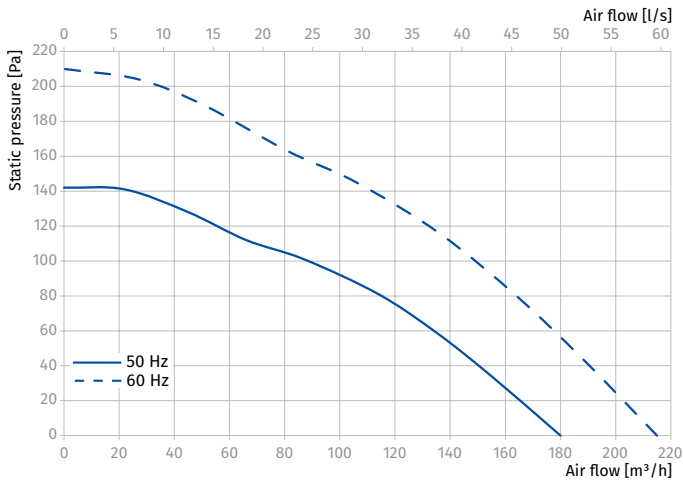

ISO BOX-F 150 ES

Sound power level, A-weighted	Total	Octave frequency band [Hz]								LpA, LpA, 3 m, 1 m	
		63	125	250	500	1000	2000	4000	8000	3 m	1 m
LWA to inlet [dBA]	53	39	40	47	50	41	40	38	27	33	43
LWA to outlet [dBA]	58	42	39	47	54	50	51	45	35	37	47
LWA to environment [dBA]	46	36	38	39	42	34	28	27	23	25	35

ISO BOX-F 200 ES

Sound power level, A-weighted	Total	Octave frequency band [Hz]								LpA, LpA, 3 m, 1 m	
		63	125	250	500	1000	2000	4000	8000	3 m	1 m
LWA to inlet [dBA]	67	55	56	58	60	58	59	57	55	46	56
LWA to outlet [dBA]	71	58	56	68	63	61	59	55	47	50	60
LWA to environment [dBA]	55	41	45	50	51	37	32	28	33	34	44

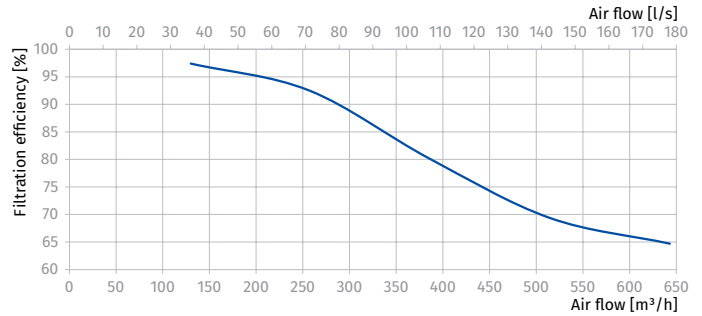
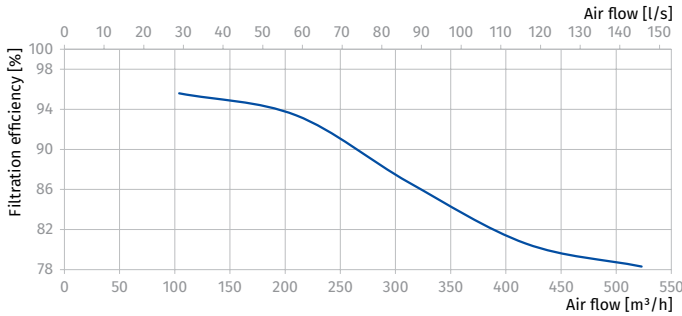
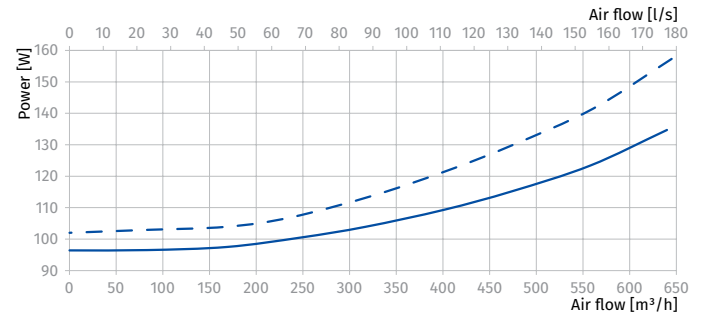
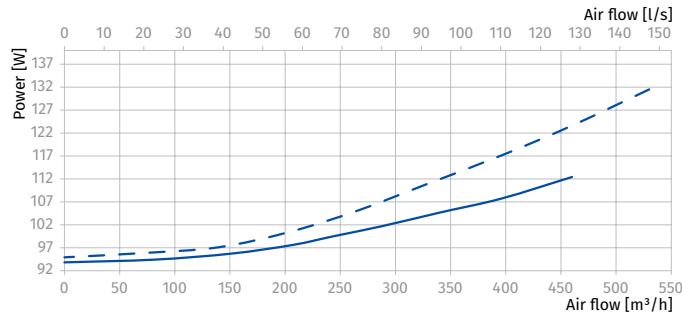
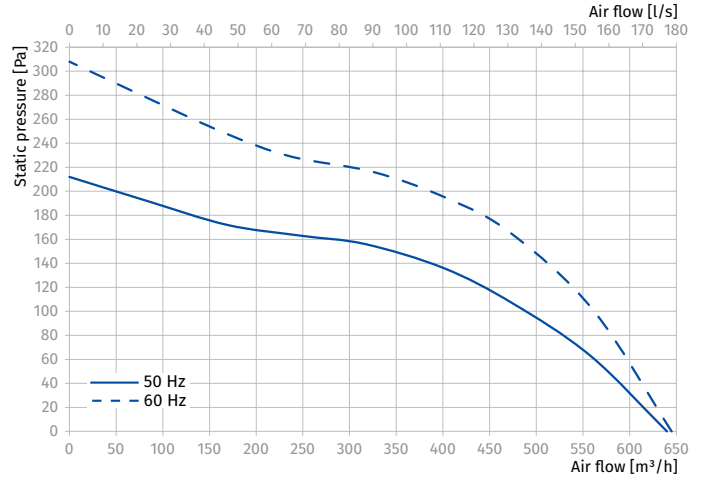
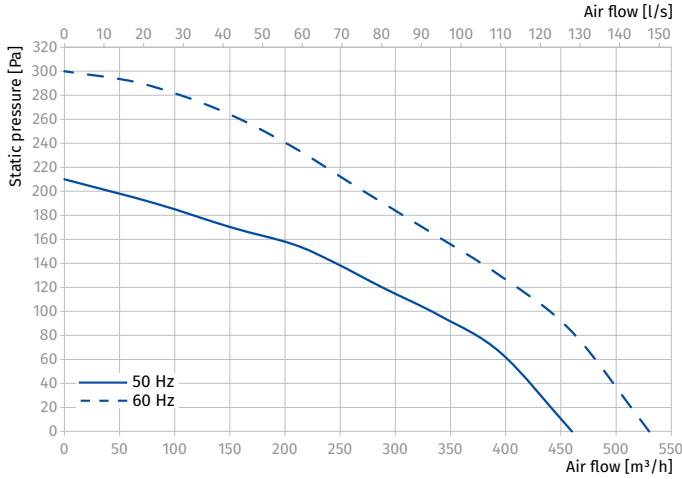

SOUND-INSULATED INLINE FANS

Parameters	Iso Box-F 100 ES V2		Iso Box-F 150 ES L V2		Iso Box-F 150 ES V2		Iso Box-F 200 ES V2	
	min	max	min	max	min	max	min	max
Speed								
Voltage [V]	1 ~ 230		1 ~ 230		1 ~ 230		1 ~ 230	
Frequency [Hz]	50		50		50		50	
Power [W]	34	42	44	52	92	117	106	123
Current [A]	0.15	0.19	0.19	0.23	0.41	0.55	0.47	0.59
Maximum air flow [m ³ /h (l/s)]	160 (44)	190 (53)	230 (64)	340 (94)	320 (89)	430 (119)	390 (108)	630 (175)
RPM [min ⁻¹]	700	1200	700	1200	700	1200	700	1200
Sound pressure at 3 m [dBA]	14	23	15	25	16	27	22	38
Transported air temperature [°C]	-25...+40		-25...+40		-25...+40		-25...+40	
Ingress protection rating	IPX4		IPX4		IPX4		IPX4	
PM2.5 Ratio [%]	98	97	98	97	97	96	98	97
SEC class	C		C		C		C	
ErP	2018		2018		2018		2018	

ISO BOX-F 100 ES V2

Sound power level, A-weighted	Total	Octave frequency band [Hz]								LpA, 3 m	LpA, 1 m	
		63	125	250	500	1000	2000	4000	8000			
min	L _{WA} to inlet [dBA]	41	26	28	33	35	36	33	28	22	20	30
	L _{WA} to outlet [dBA]	43	22	35	39	37	37	27	20	11	23	33
	L _{WA} to environment [dBA]	35	23	26	26	29	27	26	23	20	14	24
max	L _{WA} to inlet [dBA]	48	32	34	40	42	43	40	34	26	27	37
	L _{WA} to outlet [dBA]	51	27	42	47	45	44	32	24	13	30	40
	L _{WA} to environment [dBA]	43	31	34	35	38	36	34	31	26	23	33

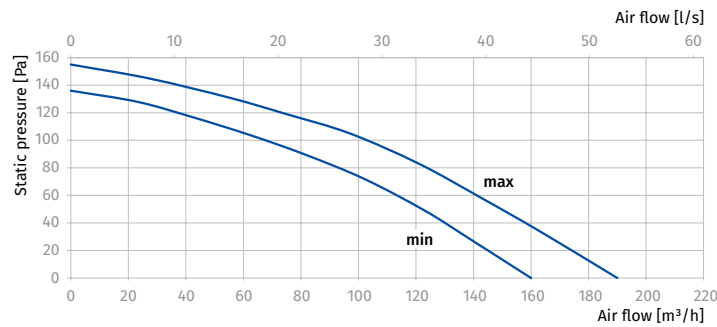

ISO BOX-F 150 ES L V2

Sound power level, A-weighted	Total	Octave frequency band [Hz]								LpA, 3 m	LpA, 1 m	
		63	125	250	500	1000	2000	4000	8000			
min	L _{WA} to inlet [dBA]	45	24	37	41	39	38	28	21	11	25	35
	L _{WA} to outlet [dBA]	48	32	34	40	42	43	40	34	26	27	37
	L _{WA} to environment [dBA]	36	20	26	31	29	28	26	23	17	15	25
max	L _{WA} to inlet [dBA]	53	28	44	49	47	46	34	25	14	33	43
	L _{WA} to outlet [dBA]	56	39	41	48	51	52	48	41	32	36	46
	L _{WA} to environment [dBA]	45	26	35	41	39	37	34	30	23	25	35

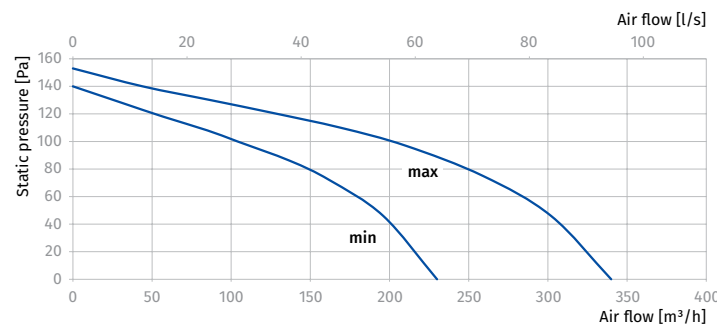

ISO BOX-F 150 ES V2

Sound power level, A-weighted	Total	Octave frequency band [Hz]								LpA, 3 m	LpA, 1 m	
		63	125	250	500	1000	2000	4000	8000			
min	LWA to inlet [dBA]	44	31	32	38	41	33	32	31	22	24	34
	LWA to outlet [dBA]	48	34	32	38	44	41	41	36	28	28	38
	LWA to environment [dBA]	36	27	29	30	32	26	21	20	17	16	26
max	LWA to inlet [dBA]	53	39	40	47	50	41	40	38	27	33	43
	LWA to outlet [dBA]	58	42	39	47	54	50	51	45	35	37	47
	LWA to environment [dBA]	48	38	40	41	44	36	29	28	24	27	37

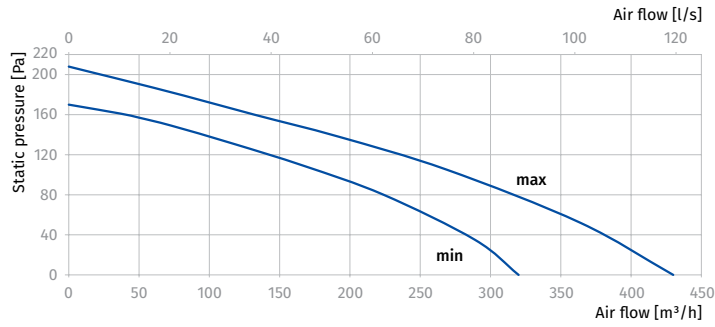

ISO BOX-F 200 ES V2

Sound power level, A-weighted	Total	Octave frequency band [Hz]								LpA, 3 m	LpA, 1 m	
		63	125	250	500	1000	2000	4000	8000			
min	LWA to inlet [dBA]	55	44	45	47	48	47	48	46	44	35	45
	LWA to outlet [dBA]	58	46	45	54	51	49	47	44	38	37	47
	LWA to environment [dBA]	43	31	34	38	39	28	24	21	25	22	32
max	LWA to inlet [dBA]	67	55	56	58	60	58	59	57	55	46	56
	LWA to outlet [dBA]	71	58	56	68	63	61	59	55	47	50	60
	LWA to environment [dBA]	58	44	48	54	55	40	34	30	36	38	48

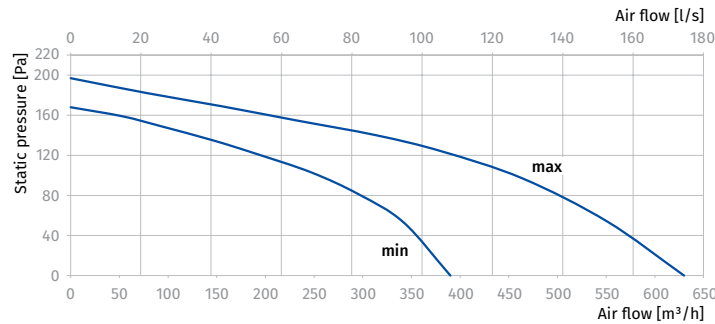

Iso-B

Sound-insulated inline centrifugal fans

Use

- Supply and extract ventilation systems installed in premises with high requirements to the noise level.
- Suitable for limited mounting space.
- Compatible with Ø 100 up to 315 mm round air ducts.



Air flow:
up to 2150 m³/h
597 l/s



Power:
from 72 W



Noise level:
from 33 dBA

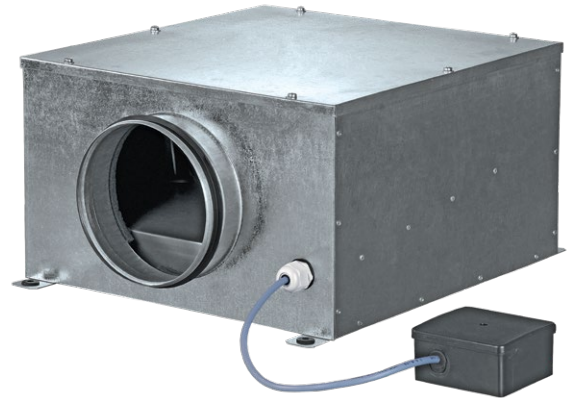

Design

- Galvanized steel casing internally filled with 30 mm thermal- and sound-insulating layer made of non-flammable foamed polyurethane.
- The connection spigots are equipped with rubber seals.
- Fixing brackets for easy mounting.

Motor

- Two-pole external rotor asynchronous motor with centrifugal impeller and backward curved blades.
- The motor is installed on specially designed vibration-damping mounts to absorb vibration and noise.
- Equipped with ball bearings for longer service life.
- Integrated thermal protection with automatic restart.
- Dynamically balanced impeller.

Speed control

- Smooth speed control with an external thyristor controller or step speed control with an external auto transformer (both available upon separate order).

Mounting

- Fixed to wall or ceiling with a fixing bracket supplied as a standard.
- Flexible air ducts are fixed on the fan spigots with clamps.
- Power is supplied through an external terminal box.

Modifications and options

- max:** high-powered motor.
- G1:** speed controller, temperature controller with external temperature sensor (cable length 4 m), power cable with mains plug.
- G11:** speed controller, temperature controller with integrated temperature sensor and power cable with mains plug.
- The **G1** and **G11** modifications enable automatic speed control depending on indoor temperature. The optimal ventilation solution for premises requiring permanent temperature control as greenhouses, orangeries, etc.
- W1:** power cable with mains plug.

SOUND-INSULATED INLINE FANS

Designation key

Series	Spigot diameter [mm]	Motor modifications	Options
Iso-B	100; 125; 150; 160; 200; 250; 315	max: high-powered motor	G1: speed controller, temperature controller with external temperature sensor, power cable with mains plug G11: speed controller, temperature controller with integrated temperature sensor and power cable mains plug W1: power cable with mains plug

Accessories

Silencers	Filter boxes	Electric heaters	Water heaters	Backdraft air dampers	Air dampers	Speed controllers	Timers/Sensors
 SD	 KFBK / KFBT	 EKH	 WKH	 VRV	 VK / VKA	 CDT E1.8	 TE(TI) / HSE(HSI) / LSE(LSI) / IRSE(IRSI)

Overall dimensions [mm]

Type	Ø D	B	B1	H	L	L1	L2	Weight [kg]
Iso-B 100	99	322	280	192	447	380	350	5.4
Iso-B 125	124	322	280	192	447	380	350	5.4
Iso-B 150	149	352	310	212	477	410	380	6.4
Iso-B 160	159	352	310	212	477	410	380	6.4
Iso-B 200	199	432	368	287	588	506	480	10.0
Iso-B 200 max	199	432	368	287	588	506	480	12.0
Iso-B 250	249	432	368	287	588	506	480	12.5
Iso-B 315	314	502	438	397	648	566	540	15.5

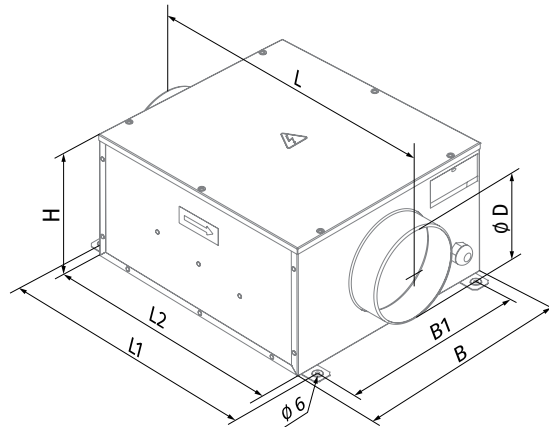

Technical data

Parameters	Iso-B 100		Iso-B 125		Iso-B 150		Iso-B 160	
Voltage [V]	1 ~ 230		1 ~ 230		1 ~ 230		1 ~ 230	
Frequency [Hz]	50	60	50	60	50	60	50	60
Power [W]	73	77	73	77	72	76	75	76
Current [A]	0.32	0.34	0.32	0.34	0.32	0.33	0.33	0.33
Maximum air flow [m ³ /h (l/s)]	240 (67)	255 (71)	330 (92)	345 (96)	420 (117)	435 (121)	420 (117)	435 (121)
RPM [min ⁻¹]	2560	2690	2590	2700	2600	2720	2690	2720
Sound pressure at 3 m [dBA]	33	34	35	36	36	37	36	37
Transported air temperature [°C]	-25...+55		-25...+55		-25...+55		-25...+55	
SEC class	C		C		C		C	
IP rating	IPX4		IPX4		IPX4		IPX4	
Motor IP rating	IP44		IP44		IP44		IP44	
ErP	2018		2018		2018		2018	

ISO-B 100

Sound power level, A-weighted	Total	Octave frequency bands [Hz]							
		63	125	250	500	1000	2000	4000	8000
L _{WA} to inlet [dBA]	59	53	57	54	52	51	54	51	47
L _{WA} to outlet [dBA]	68	49	50	53	56	66	63	56	54
L _{WA} to environment [dBA]	40	27	29	32	31	34	29	29	20

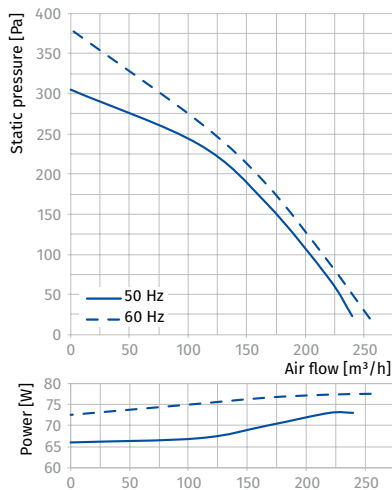

ISO-B 125

Sound power level, A-weighted	Total	Octave frequency bands [Hz]							
		63	125	250	500	1000	2000	4000	8000
L _{WA} to inlet [dBA]	64	51	51	54	56	54	55	53	51
L _{WA} to outlet [dBA]	65	50	49	59	55	61	61	58	51
L _{WA} to environment [dBA]	38	29	32	33	33	33	31	28	25

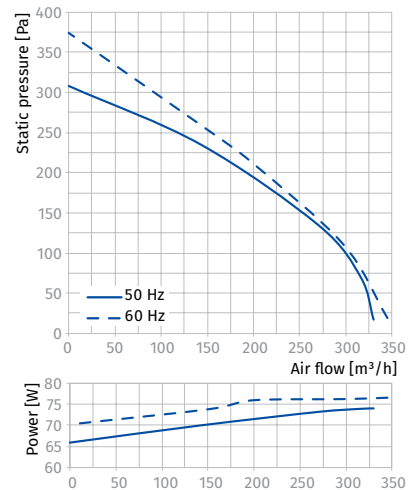

ISO-B 150

Sound power level, A-weighted	Total	Octave frequency bands [Hz]							
		63	125	250	500	1000	2000	4000	8000
L _{WA} to inlet [dBA]	62	49	50	58	56	54	55	52	50
L _{WA} to outlet [dBA]	66	43	44	59	55	62	60	55	53
L _{WA} to environment [dBA]	41	26	30	35	34	34	30	26	25

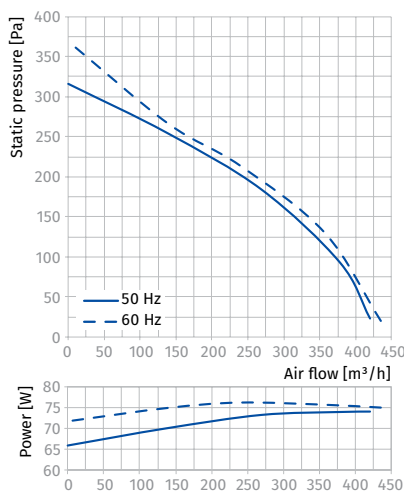

ISO-B 160

Sound power level, A-weighted	Total	Octave frequency bands [Hz]							
		63	125	250	500	1000	2000	4000	8000
L _{WA} to inlet [dBA]	62	50	51	60	56	52	55	54	51
L _{WA} to outlet [dBA]	68	48	47	57	60	67	63	59	56
L _{WA} to environment [dBA]	41	28	26	32	33	36	34	25	23

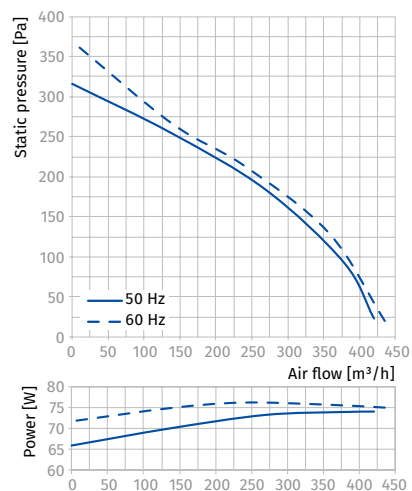

Parameters	Iso-B 200		Iso-B 200 max		Iso-B 250		Iso-B 315	
Voltage [V]	1 ~ 230		1 ~ 230		1 ~ 230		1 ~ 230	
Frequency [Hz]	50	60	50	60	50	60	50	60
Power [W]	103	122	195	232	198	238	322	367
Current [A]	0.45	0.53	0.85	1.02	0.87	1.04	1.4	1.6
Maximum air flow [m³/h (l/s)]	730 (203)	750 (208)	950 (264)	960 (267)	1300 (361)	1315 (365)	2150 (597)	2150 (597)
RPM [min⁻¹]	2550	2740	2570	2690	2420	2730	2670	2850
Sound pressure at 3 m [dBA]	38	39	41	42	41	43	43	44
Transported air temperature [°C]	-25...+50	-25...+45	-25...+45	-25...+45	-25...+50	-25...+45	-25...+45	-25...+45
SEC class	B		B		-		-	
IP rating	IPX4		IPX4		IPX4		IPX4	
Motor IP rating	IP44		IP44		IP44		IP44	
ErP	2018		2018		-		-	

ISO-B 200

Sound power level, A-weighted	Total	Octave frequency bands [Hz]							
		63	125	250	500	1000	2000	4000	8000
LWA to inlet [dBA]	52	37	38	45	45	39	39	36	26
LWA to outlet [dBA]	67	49	46	55	64	59	60	53	41
LWA to environment [dBA]	43	33	35	33	38	25	31	25	25

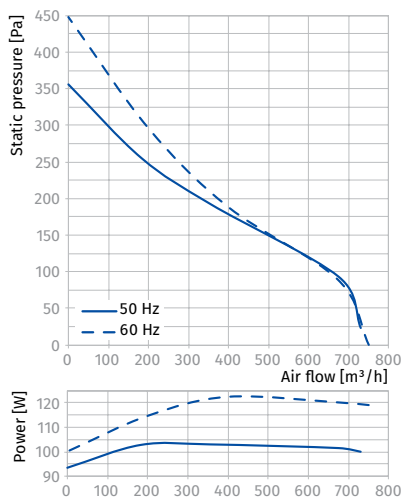

ISO-B 200 MAX

Sound power level, A-weighted	Total	Octave frequency bands [Hz]							
		63	125	250	500	1000	2000	4000	8000
LWA to inlet [dBA]	53	41	43	53	51	47	44	44	36
LWA to outlet [dBA]	70	48	49	57	68	65	63	58	51
LWA to environment [dBA]	45	29	32	37	40	27	29	26	27

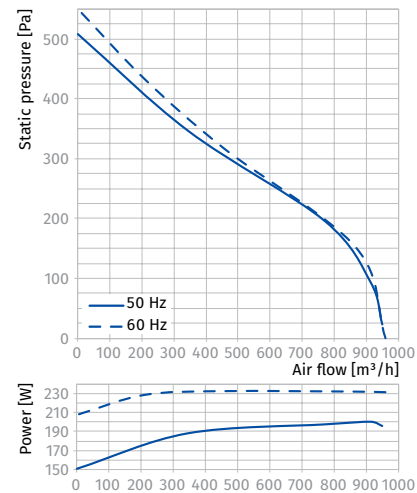

ISO-B 250

Sound power level, A-weighted	Total	Octave frequency bands [Hz]							
		63	125	250	500	1000	2000	4000	8000
LWA to inlet [dBA]	59	44	45	54	51	47	45	45	38
LWA to outlet [dBA]	74	51	51	62	70	67	64	61	55
LWA to environment [dBA]	46	33	36	41	42	30	26	23	27

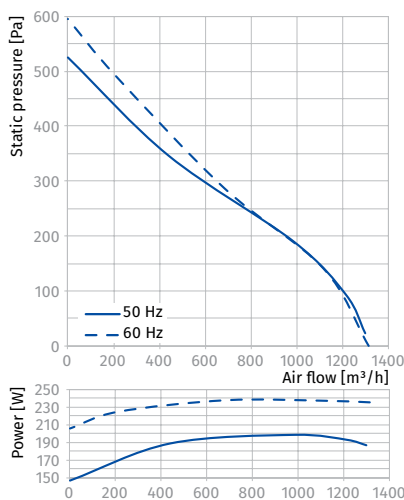

ISO-B 315

Sound power level, A-weighted	Total	Octave frequency bands [Hz]							
		63	125	250	500	1000	2000	4000	8000
LWA to inlet [dBA]	59	45	47	56	47	48	50	44	40
LWA to outlet [dBA]	75	52	51	59	68	68	65	62	54
LWA to environment [dBA]	48	41	41	44	43	36	28	32	29

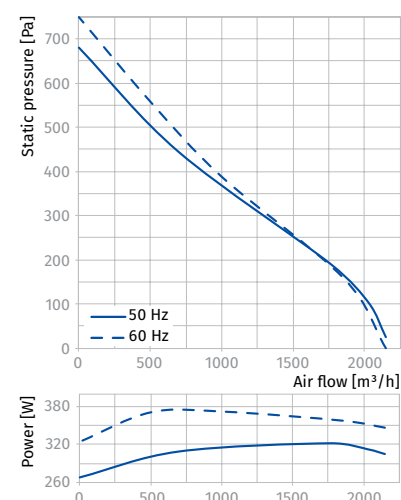

Iso-B EC

Sound-insulated inline centrifugal fans

Use

- Supply and extract ventilation systems installed in premises with high requirements to the noise level.
- Suitable for limited mounting space.
- Unit design includes a possibility of space-restricted installation above suspended ceilings.
- Compatible with Ø 100 up to 315 mm round air ducts.



Air flow:
up to 1260 m³/h
350 l/s



Power:
from 92.6 W



Noise level:
from 32 dBA



Design

- Galvanized steel casing internally filled thermal- and sound-insulating layer.
- The connection spigots are equipped with rubber seals.
- Fixing brackets for easy mounting.

Motor

- High-efficient direct current EC motor with external rotor and backward curved blades.
- EC technology meets the up-to-date requirements to energy-saving and controllable ventilation and provides up to 35 % energy saving as compared to asynchronous motors.
- EC motor ensures totally controllable speed range for the fan and has integrated overheating protection with automatic restart.
- EC motor has no friction and wearing parts as capacitor and brushes. Instead a maintenance-free EC controller electronic circuit board is used.
- The impeller is dynamically balanced.
- The fan is compatible with 50 Hz and 60 Hz power mains and the maximum speed does not depend on power mains frequency.

Speed control

- The fan speed is controlled with a 0–10 V control signal from the following sources:
 - integrated or external speed controller
 - controller with sensors
 - central BMS system.

- The control signal value changes depending on air temperature, pressure, smoke concentration and other parameters.
- During signal value change the fan with EC motor correspondingly changes the rotations speed and delivers required air volume to the ventilation system.
- The computer central building management systems (BMS) enable integration of several EC motors in network and precise individual operation control for each fan.

Mounting

- The fans are intended for installation in round air ducts. They are installed between the air ducts.
- The use of flexible connectors requires fixation of the fan on the building structure by means of supports, mounts or fixing brackets.
- The fan can be fixed in any position, taking into account the air flow direction indicated by the arrow on the fan casing.
- While mounting the fan provide enough access for servicing and repair operations.
- Electrical connection and installation must be performed in accordance with the instruction manual and the electrical connections diagram applied to the terminal box.







Modifications and options

- FR1:** smooth speed controller adjustable from 0 to 100 % and power cable with mains plug.
- W1:** power cable with mains plug.

Designation key

Series	Motor	Spigot diameter [mm]	Options
Iso-B	EC: electronically commutated motor	100; 125; 150; 160; 200; 250; 315	FR1: smooth speed controller adjustable from 0 to 100 % and power cable with mains plug W1: power cable with mains plug

Accessories

Silencers	Filter boxes	Electric heaters	Water heaters	Backdraft air dampers	Air dampers	Speed controllers
 SD	 KFBK / KFBT	 EKH	 WKH	 VRV	 VK / VKA	 CDT E/0-10

Overall dimensions [mm]

Type	Ø D	L	L1	B	B1	H
Iso-B EC 100	99	325	375 (388)	355	447	200
Iso-B EC 125	124	325	375 (388)	355	447	200
Iso-B EC 150	149	325	405 (418)	385	447	220
Iso-B EC 160	159	325	405 (418)	385	447	220
Iso-B EC 200	199	435	490 (503)	485	590	295
Iso-B EC 250	249	435	490 (503)	485	590	295
Iso-B EC 315	314	435	560 (663)	545	650	405

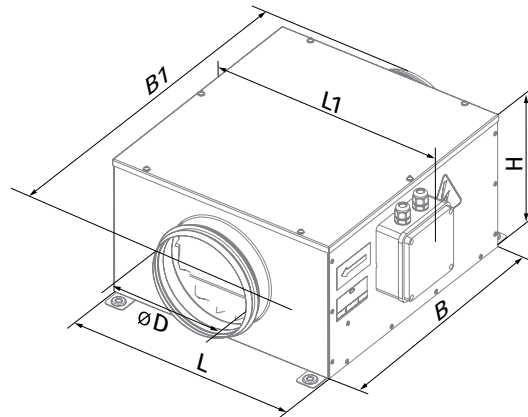

Technical data

Parameters	Iso-B EC 100	Iso-B EC 125	Iso-B EC 150 Iso-B EC 160	Iso-B EC 200	Iso-B EC 250	Iso-B EC 315
Voltage [V]	1 ~ 230	1 ~ 230	1 ~ 230	1 ~ 230	1 ~ 230	1 ~ 230
Frequency [Hz]	50/60	50/60	50/60	50/60	50/60	50/60
Power [W]	92.7	92.6	94.8	101.6	163.7	164.3
Current [A]	0.75	0.75	0.77	0.83	1.34	1.35
Maximum air capacity [m ³ /h (l/s)]	278 (77)	357 (99)	425 (118)	700 (194)	1145 (318)	1260 (350)
RPM [min ⁻¹]	3200	3200	3200	2580	2510	2620
Sound pressure level at 3 m distance [dBA]	32	34	35	37	40	42
Max. transported air temperature [°C]	-25...+60	-25...+60	-25...+60	-25...+60	-25...+60	-25...+60
Energy efficiency class	C	C	B	B	B	-
IP rating	IPX4	IPX4	IPX4	IPX4	IPX4	IPX4
Motor IP rating	IP55	IP55	IP55	IP55	IP55	IP55
ErP	2018	2018	2018	2018	2018	2018

ISO-B EC 100

Sound power level, A-weighted	Total	Octave frequency bands [Hz]								LpA 3 m	LpA 1 m
		63	125	250	500	1000	2000	4000	8000		
LWA to inlet [dBA]	61	47	55	59	51	47	41	41	32	41	51
LWA to outlet [dBA]	64	52	59	60	57	47	41	42	36	44	54
LWA to environment [dBA]	53	42	49	49	41	36	31	27	23	32	42

ISO-B EC 125

Sound power level, A-weighted	Total	Octave frequency bands [Hz]								LpA 3 m	LpA 1 m
		63	125	250	500	1000	2000	4000	8000		
LWA to inlet [dBA]	60	46	54	58	50	46	40	40	31	40	50
LWA to outlet [dBA]	63	51	58	59	56	46	40	41	35	43	53
LWA to environment [dBA]	55	44	51	51	43	38	32	28	24	34	44

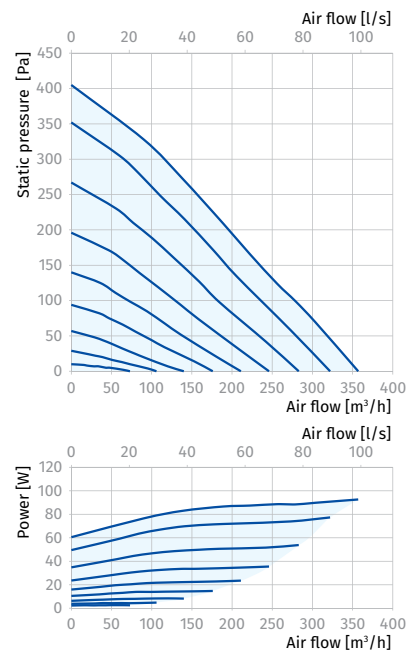
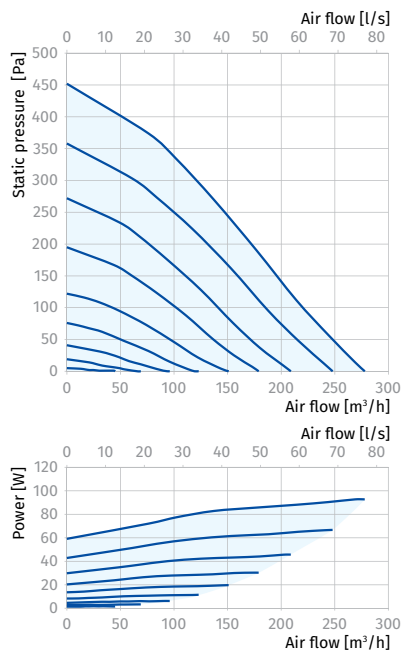

ISO-B EC 150 / ISO-B EC 160

Sound power level, A-weighted	Total	Octave frequency bands [Hz]								LpA 3 m	LpA 1 m
		63	125	250	500	1000	2000	4000	8000		
LWA to inlet [dBA]	63	48	56	60	52	48	42	42	32	42	52
LWA to outlet [dBA]	65	53	60	61	58	48	42	43	36	45	55
LWA to environment [dBA]	56	45	52	52	44	39	33	29	24	35	45

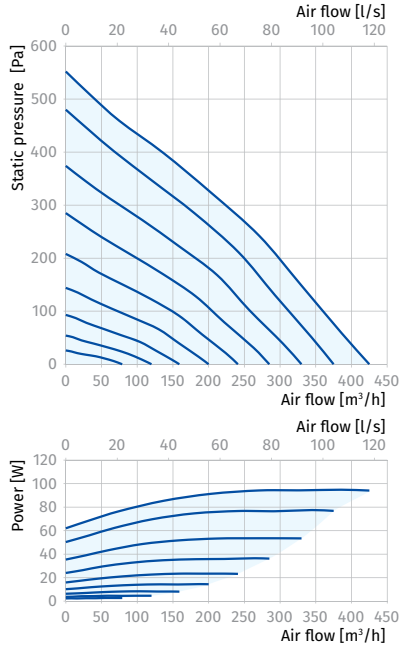

ISO-B EC 200

Sound power level, A-weighted	Total	Octave frequency bands [Hz]								LpA 3 m	LpA 1 m
		63	125	250	500	1000	2000	4000	8000		
LWA to inlet [dBA]	62	46	59	59	41	37	34	30	23	41	51
LWA to outlet [dBA]	65	52	64	51	47	43	35	29	22	44	54
LWA to environment [dBA]	57	46	53	54	45	40	33	30	25	37	47

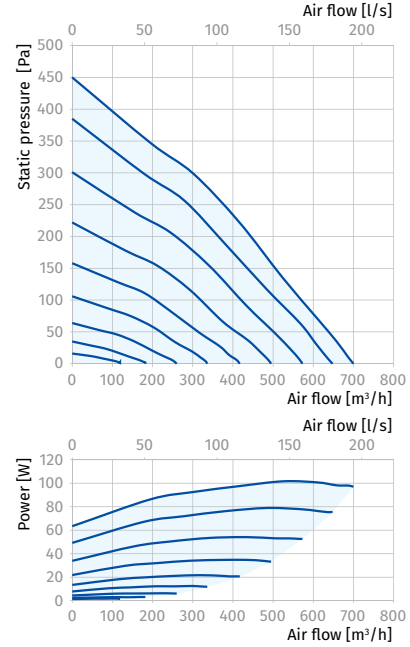

ISO-B EC 250

Sound power level, A-weighted	Total	Octave frequency bands [Hz]								LpA 3 m	LpA 1 m
		63	125	250	500	1000	2000	4000	8000		
LWA to inlet [dBA]	66	49	62	62	44	39	36	32	24	45	55
LWA to outlet [dBA]	68	55	68	54	50	45	37	31	24	48	58
LWA to environment [dBA]	61	49	57	57	48	43	36	32	27	40	50

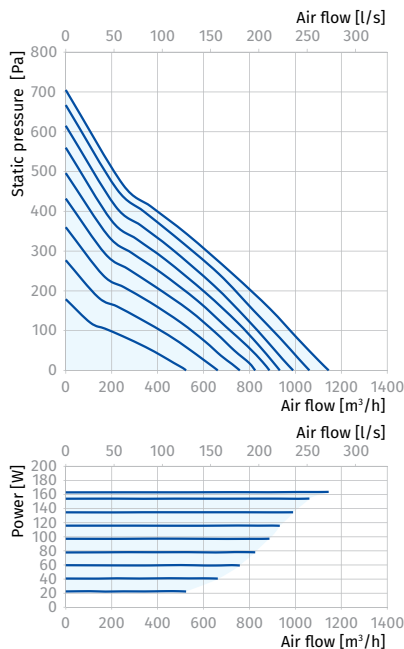

ISO-B EC 315

Sound power level, A-weighted	Total	Octave frequency bands [Hz]								LpA 3 m	LpA 1 m
		63	125	250	500	1000	2000	4000	8000		
LWA to inlet [dBA]	67	52	61	65	56	51	45	45	35	46	56
LWA to outlet [dBA]	70	56	65	66	62	51	44	46	39	49	59
LWA to environment [dBA]	62	51	58	59	50	44	37	32	28	42	52

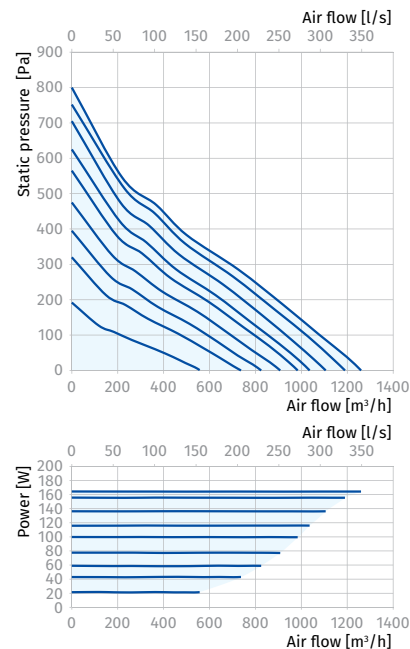

Iso-RB

Sound-insulated inline centrifugal fans

Use

- Supply and exhaust ventilation systems in premises with high requirements to the noise level and with limited space for mounting.
- Possibility of space-restricted installation above suspended ceilings.
- Compatible with Ø 100–500 mm air ducts.



Air flow:
up to 7000 m³/h
1945 l/s



Power:
from 58 W



Noise level:
from 34 dBA



Design

- The fan casing is made of aluzinc.
- For easy installation and operation, the top cover of the fan is secured with a special lock.
- Heat- and sound insulation is made of non-combustible 50 mm mineral wool layer. To ensure better noise absorption, the inner surface of the insulation is made of a perforated metal sheet.
- The round connecting spigots are rubber sealed.



Motor

- The fans are equipped with asynchronous motors with an external rotor and centrifugal impellers with backward curved blades.
- The motors are equipped with an integrated overheating protection with automatic restart.
- The use of ball bearings with specially selected lubricating oil guarantees low noise and makes the fan completely maintenance-free.

Speed control

- Smooth or step speed control by means of a thyristor or autotransformer speed controller.
- Several fans can be connected to one controller, provided that the total power and operating current do not exceed the nominal parameters of the controller.

Mounting

- The round inline fans are designed for connection to round air ducts. The fans are installed at an air duct junction. The use of flexible connectors requires fixation of the fan on the building structure by means of supports, mounts or fixing brackets.
- The fan can be fixed in any position with respect to the air flow direction indicated by the arrow on the fan casing. While mounting the fan provide enough access for servicing and repair operations.

Designation key

Series	Spigot diameter	Motor	Options
Iso-RB	100; 125; 150; 160; 200; 250; 315; 355; 400; 450; 500	max: high-powered motor	W1: power cable with mains plug

Accessories

Silencers	Filter boxes	Electric heaters	Water heaters	Backdraft air dampers	Air dampers	Speed controllers	Timers/Sensors
 SD	 KFBK / KFBT	 EKH	 WKH	 VRV	 VK / VKA	 CDT E1.8	 TE(TI) / HSE(HSI) / LSE(LSI) / IRSE(IRSI)

Overall dimensions [mm]

Type	Ø D	B	B1	H	L	L1	L2	Weight [kg]
Iso-RB 100	99	420	228	258	517	507	414	13
Iso-RB 125	124	420	228	258	517	507	414	13
Iso-RB 125 max	124	533	333	280	630	617	525	19
Iso-RB 150	149	470	278	282	566	586	493	17
Iso-RB 160	159	470	278	282	566	586	493	17
Iso-RB 200	198	535	357.5	355	632	628	535	22.6
Iso-RB 250	248	677	537	429	774	759	666	33
Iso-RB 315 max	313	760	560	460	857	747	666	48
Iso-RB 355	354	830	641	500	927	885	804	58
Iso-RB 400	399	927	737	578	1024	957	876	78.5
Iso-RB 450	449	1049	858	607	1152	1049	968	84
Iso-RB 500	499	1203	993	744	1300	1263	1182	129

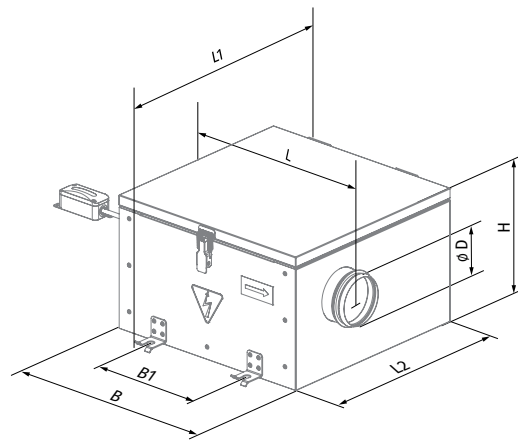

Technical data

Parameters	Iso-RB 100	Iso-RB 125	Iso-RB 125 max	Iso-RB 150
Voltage [V]	1 ~ 230	1 ~ 230	1 ~ 230	1 ~ 230
Frequency [Hz]	50	50	50	50
Power [W]	58	61	88	84
Current [A]	0.25	0.28	0.37	0.37
Maximum air flow [m ³ /h (l/s)]	285 (79)	330 (92)	484 (134)	485 (135)
RPM [min ⁻¹]	2530	2560	2670	2620
Sound pressure level at 3 m distance [dBA]	34	35	40	38
Transported air temperature [°C]	-25 ... +55	-25 ... +55	-25 ... +55	-25 ... +55
IP rating	IPX4	IPX4	IPX4	IPX4
Motor IP rating	IP44	IP44	IP44	IP44
SEC class	C	C	C	C
ErP	2018	2018	2018	2018

ISO-RB 100

Sound power level, A-weighted	Total	Octave frequency bands [Hz]								LpA 3 m	LpA 1 m
		63	125	250	500	1000	2000	4000	8000		
LWA to inlet [dBA]	62	48	57	60	52	48	42	42	32	42	52
LWA to outlet [dBA]	79	65	74	76	72	58	51	53	44	59	69
LWA to environment [dBA]	54	40	44	50	50	42	41	39	39	34	44

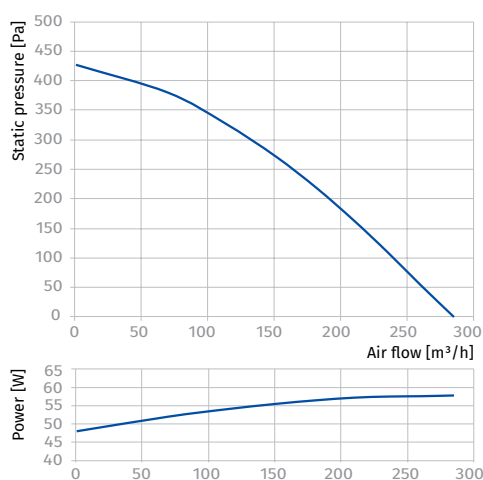

ISO-RB 125

Sound power level, A-weighted	Total	Octave frequency bands [Hz]								LpA 3 m	LpA 1 m
		63	125	250	500	1000	2000	4000	8000		
LWA to inlet [dBA]	63	49	57	61	52	48	42	42	33	43	53
LWA to outlet [dBA]	81	66	76	78	73	60	52	54	45	61	71
LWA to environment [dBA]	55	41	45	51	51	43	42	40	39	35	45

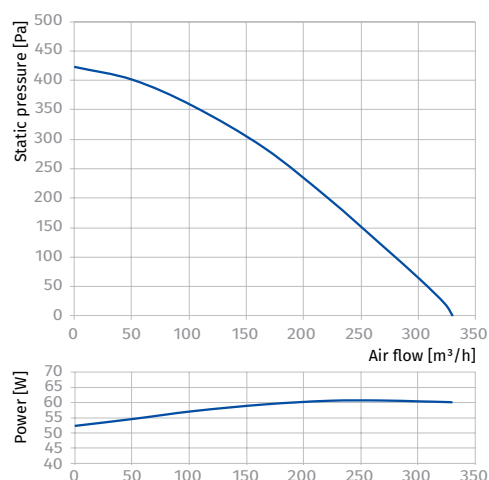

ISO-RB 125 MAX

Sound power level, A-weighted	Total	Octave frequency bands [Hz]								LpA 3 m	LpA 1 m
		63	125	250	500	1000	2000	4000	8000		
LWA to inlet [dBA]	71	56	65	70	60	55	48	48	37	51	61
LWA to outlet [dBA]	88	72	83	85	80	65	57	59	50	68	78
LWA to environment [dBA]	60	43	52	58	53	44	42	40	40	40	50

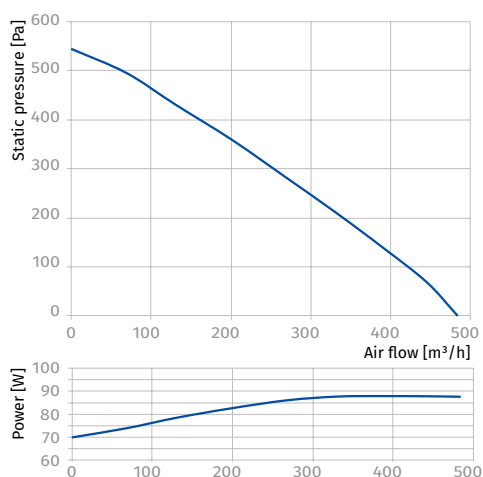

ISO-RB 150

Sound power level, A-weighted	Total	Octave frequency bands [Hz]								LpA 3 m	LpA 1 m
		63	125	250	500	1000	2000	4000	8000		
LWA to inlet [dBA]	70	55	64	68	59	54	47	47	37	50	60
LWA to outlet [dBA]	86	71	81	83	78	64	55	58	49	66	76
LWA to environment [dBA]	59	42	50	57	52	43	41	39	39	38	48

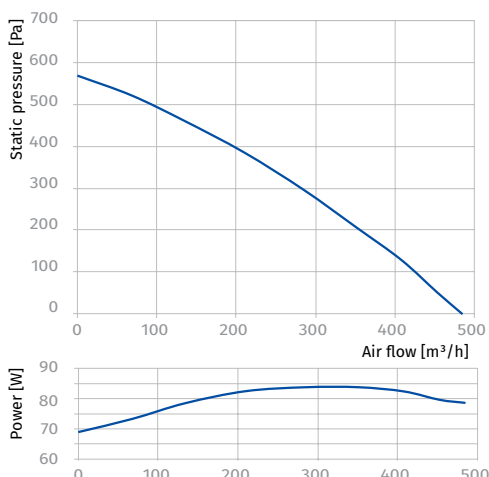

Parameters	Iso-RB 160	Iso-RB 200	Iso-RB 250	Iso-RB 315 max
Voltage [V]	1 ~ 230	1 ~ 230	1 ~ 230	3~ 380
Frequency [Hz]	50	50	50	50
Power [W]	86	164	320	654
Current [A]	0.38	0.71	1.40	1.10
Maximum air flow [m³/h (l/s)]	500 (139)	770 (314)	1515 (421)	2700 (750)
RPM [min ⁻¹]	2670	2580	2615	2600
Sound pressure level at 3 m distance [dBA]	38	42	45	48
Transported air temperature [°C]	-25 ... +55	-25 ... +55	-25 ... +55	-25 ... +55
IP rating	IPX4	IPX4	IPX4	IPX4
Motor IP rating	IP44	IP44	IP44	IP54
SEC class	C	C	-	-
ErP	2018	2018	2018	2018

ISO-RB 160

Sound power level, A-weighted	Total	Octave frequency bands [Hz]								LpA 3 m	LpA 1 m
		63	125	250	500	1000	2000	4000	8000		
LWA to inlet [dBA]	70	55	64	68	59	54	47	47	37	50	60
LWA to outlet [dBA]	87	72	83	84	79	65	56	59	49	67	77
LWA to environment [dBA]	58	42	50	57	52	43	42	39	39	38	48

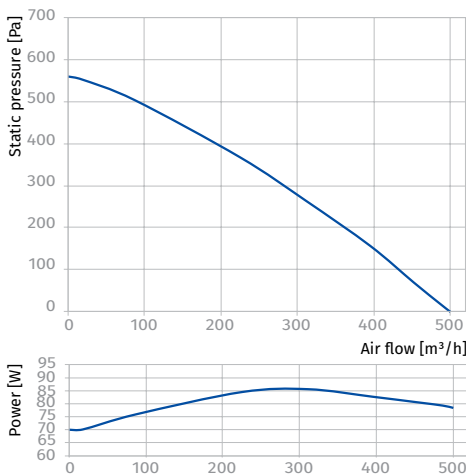

ISO-RB 200

Sound power level, A-weighted	Total	Octave frequency bands [Hz]								LpA 3 m	LpA 1 m
		63	125	250	500	1000	2000	4000	8000		
LWA to inlet [dBA]	73	57	67	71	61	57	49	49	38	53	63
LWA to outlet [dBA]	81	67	77	78	74	60	52	54	46	61	71
LWA to environment [dBA]	62	39	46	62	51	45	45	35	34	42	52

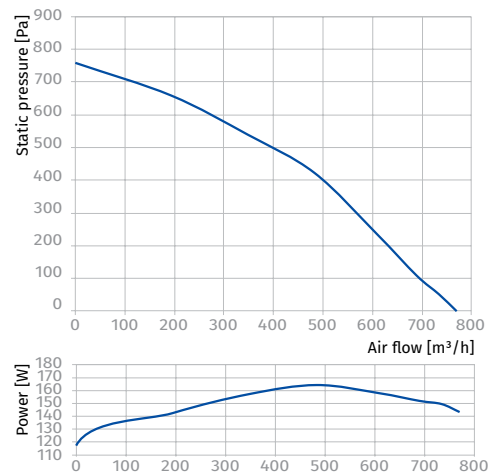

ISO-RB 250

Sound power level, A-weighted	Total	Octave frequency bands [Hz]								LpA 3 m	LpA 1 m
		63	125	250	500	1000	2000	4000	8000		
LWA to inlet [dBA]	77	60	70	75	64	59	52	52	40	56	66
LWA to outlet [dBA]	81	67	77	79	74	60	52	55	46	61	71
LWA to environment [dBA]	65	46	60	63	55	48	33	33	34	45	55

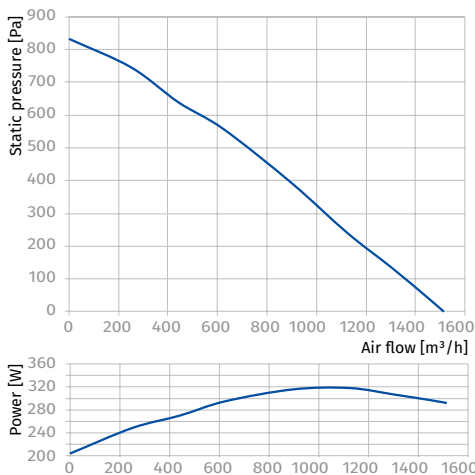

ISO-RB 315 MAX

Sound power level, A-weighted	Total	Octave frequency bands [Hz]								LpA 3 m	LpA 1 m
		63	125	250	500	1000	2000	4000	8000		
LWA to inlet [dBA]	87	80	83	81	77	70	66	64	62	66	76
LWA to outlet [dBA]	90	80	80	79	83	81	83	80	76	69	79
LWA to environment [dBA]	68	55	56	67	58	50	53	52	53	48	58

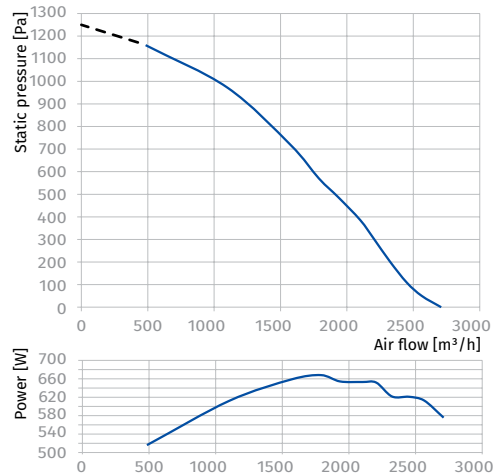

SOUND-INSULATED INLINE FANS

Parameters	Iso-RB 355	Iso-RB 400	Iso-RB 450
Voltage [V]	1 ~ 230	1 ~ 230	1 ~ 230
Frequency [Hz]	50	50	50
Power [W]	202	349	482
Current [A]	0.89	2.00	2.13
Maximum air flow [m³/h (l/s)]	2235 (621)	2860 (795)	3750 (1042)
RPM [min ⁻¹]	1330	1380	1350
Sound pressure level at 3 m distance [dBA]	48	48	50
Transported air temperature [°C]	-25 ... +55	-25 ... +55	-25 ... +55
IP rating	IPX4	IPX4	IPX4
Motor IP rating	IP44	IP54	IP54
SEC class	-	-	-
ErP	2018	2018	2018

ISO-RB 355

Sound power level, A-weighted	Total	Octave frequency bands [Hz]								LpA 3 m	LpA 1 m
		63	125	250	500	1000	2000	4000	8000		
LWA to inlet [dBA]	78	61	72	77	66	61	53	53	41	58	68
LWA to outlet [dBA]	83	68	78	80	76	61	53	56	47	63	73
LWA to environment [dBA]	68	52	66	64	47	41	32	33	33	48	58

ISO-RB 400

Sound power level, A-weighted	Total	Octave frequency bands [Hz]								LpA 3 m	LpA 1 m
		63	125	250	500	1000	2000	4000	8000		
LWA to inlet [dBA]	84	66	78	83	71	66	57	57	44	64	74
LWA to outlet [dBA]	90	74	85	87	82	66	58	60	51	69	79
LWA to environment [dBA]	69	63	65	64	54	46	34	35	35	48	58

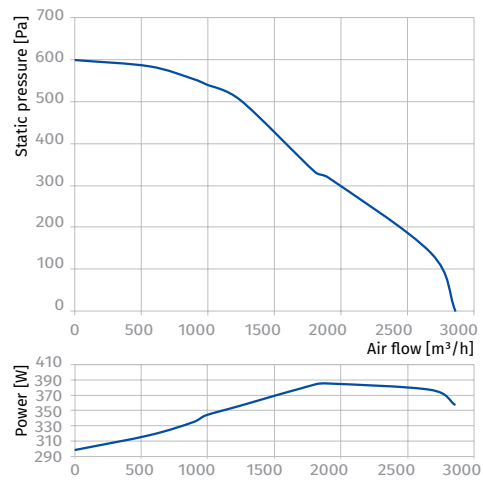
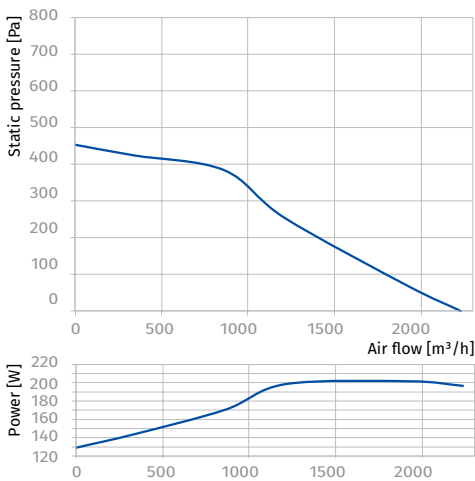

ISO-RB 450

Sound power level, A-weighted	Total	Octave frequency bands [Hz]								LpA 3 m	LpA 1 m
		63	125	250	500	1000	2000	4000	8000		
LWA to inlet [dBA]	82	64	75	81	69	64	56	56	43	62	72
LWA to outlet [dBA]	89	73	84	86	81	66	57	60	50	69	79
LWA to environment [dBA]	70	57	67	67	54	52	43	41	36	50	60

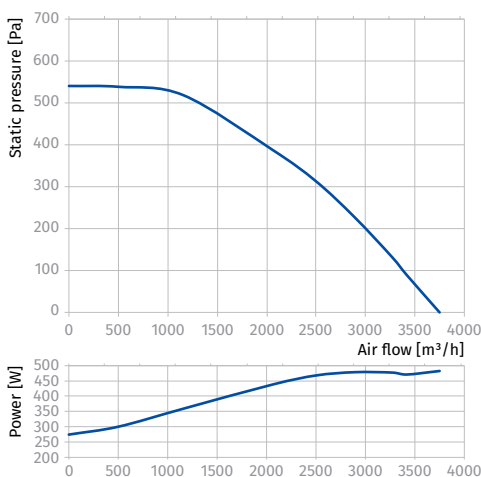

Parameters	Iso-RB 500 (Δ)	Iso-RB 500 (Y)
Voltage [V]	1 ~ 230	3~ 400
Frequency [Hz]	50	50
Power [W]	730	780
Current [A]	2.82	1.60
Maximum air flow [m³/h (l/s)]	7000 (1945)	6720 (1867)
RPM [min ⁻¹]	980	948
Sound pressure level at 3 m distance [dBA]	56	54
Transported air temperature [°C]	-25 ... +55	-25 ... +55
IP rating	IPX4	IPX4
Motor IP rating	IP54	IP54
SEC class	-	-
ErP	2018	2018

ISO-RB 500 (Δ)

Sound power level, A-weighted	Total	Octave frequency bands [Hz]								LpA 3 m	LpA 1 m
		63	125	250	500	1000	2000	4000	8000		
LWA to inlet [dBA]	87	69	80	86	74	68	59	59	46	67	77
LWA to outlet [dBA]	92	76	88	90	84	69	60	62	52	72	82
LWA to environment [dBA]	76	68	75	67	52	50	48	46	40	56	66

ISO-RB 500 (Y)

Sound power level, A-weighted	Total	Octave frequency bands [Hz]								LpA 3 m	LpA 1 m
		63	125	250	500	1000	2000	4000	8000		
LWA to inlet [dBA]	85	66	78	83	71	66	57	57	44	64	74
LWA to outlet [dBA]	90	75	86	88	83	67	58	61	51	70	80
LWA to environment [dBA]	74	66	73	65	51	49	47	45	39	54	64

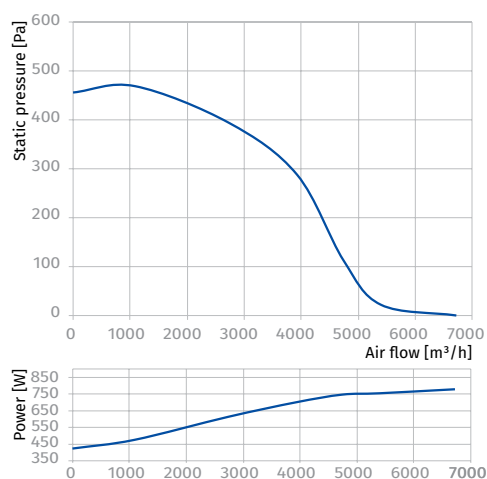
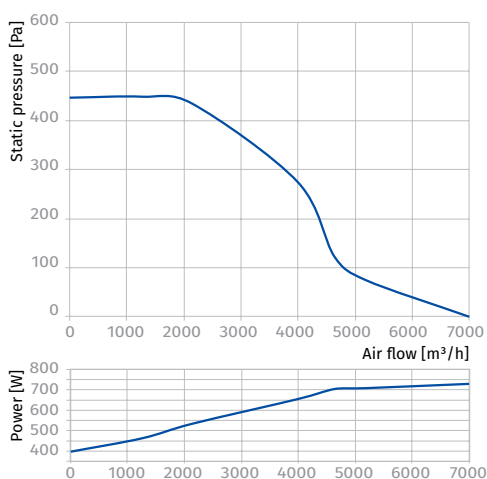

Iso-RB EC

Sound-insulated inline centrifugal fans

Use

- Supply and exhaust ventilation systems in premises with high requirements to the noise level and with limited space for mounting.
- Possibility of space-restricted installation above suspended ceilings.
- Compatible with Ø 100–500 mm air ducts.



Air flow:
up to 7145 m³/h
1985 l/s



Power:
from 69 W



Noise level:
from 37 dBA



Design

- The fan casing is made of aluzinc.
- For easy installation and operation, the top cover of the fan is secured with a special lock.
- Heat- and sound insulation is made of non-combustible 50 mm mineral wool layer. To ensure better noise absorption, the inner surface of the insulation is made of a perforated metal sheet.
- The round connecting spigots are rubber sealed.



Speed control

- The fan speed is controlled with a 0–10 V control signal from the following sources:
 - integrated or external speed controller
 - controller with sensors
 - central BMS system.
- The control signal value changes depending on air temperature, pressure, smoke concentration and other parameters.
- During signal value change the fan with EC motor correspondingly changes the rotations speed and delivers required air volume to the ventilation system.
- The computer central building management systems (BMS) enable integration of several EC motors in network and precise individual operation control for each fan.

Mounting

- The round inline fans are designed for connection to round air ducts. The fans are installed at an air duct junction.
- The use of flexible connectors requires fixation of the fan on the building structure by means of supports, mounts or fixing brackets.
- The fan can be fixed in any position with respect to the air flow direction indicated by the arrow on the fan casing. While mounting the fan provide enough access for servicing and repair operations.

Motor

- High-efficient direct current EC motor with external rotor and backward curved blades.
- EC technology meets the up-to-date requirements to energy-saving and controllable ventilation and provides up to 35 % energy saving as compared to asynchronous motors.
- EC motor ensures totally controllable speed range for the fan and has integrated overheating protection with automatic restart.
- EC motor has no friction and wearing parts as capacitor und brushes. Instead a maintenance-free EC controller electronic circuit board is used.
- The impeller is dynamically balanced.
- The fan is compatible with 50 Hz and 60 Hz power mains and the maximum speed does not depend on power mains frequency.

Designation key

Series	Motor	Duct diameter [mm]	Options
Iso-RB	EC: synchronous electronically commutated motor	100; 125; 150; 160; 200; 250; 315; 355; 400; 450; 500	W1: power cable with mains plug

Accessories

Silencers	Filter boxes	Electric heaters	Water heaters	Backdraft air dampers	Air dampers	Speed controllers	Timers/Sensors
 SD	 KFBK / KFBT	 EKH	 WKH	 VRV	 VK / VKA	 CDT E/0-10	 TE(TI) / HSE(HSI) / LSE(LSI) / IRSE(IRSI)

Overall dimensions [mm]

Type	Ø D	B	B1	B2	H	L1	L2	Weight [kg]
Iso-RB EC 100	99	420	228	517	270	507	414	12
Iso-RB EC 125	124	420	228	517	270	507	414	12
Iso-RB EC 150	149	420	228	517	270	507	414	12
Iso-RB EC 160	159	420	228	517	270	507	414	12
Iso-RB EC 200	198	551	374	648	328	646	553	20
Iso-RB EC 250	248	665	487	762	371	709	616	27
Iso-RB EC 315	313	807	600	904	505	818	737	47
Iso-RB EC 355	354	807	600	904	505	818	737	47
Iso-RB EC 400	399	807	600	904	505	818	737	47
Iso-RB EC 450	449	885	670	982	580	886	805	60
Iso-RB EC 500	499	1049	800	1146	660	1079	998	86

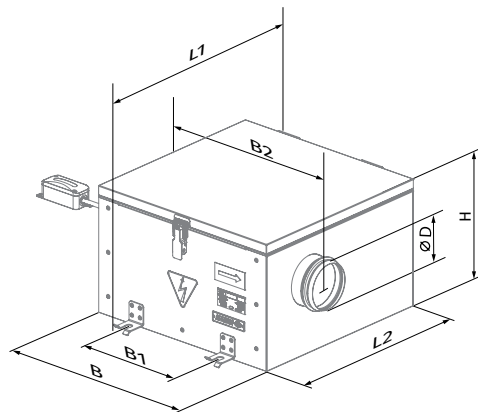

Technical data

Parameters	Iso-RB EC 100	Iso-RB EC 125	Iso-RB EC 150
Voltage [V/50 (60) Hz]	1 ~ 230	1 ~ 230	1 ~ 230
Power [W]	69	78	81
Current [A]	0.55	0.59	0.61
Maximum air flow [m ³ /h (l/s)]	341 (95)	444 (123)	495 (138)
RPM [min ⁻¹]	3270	3270	3270
Sound pressure level at 3 m distance [dBA]	37	39	40
Transported air temperature [°C]	-25...+55	-25...+55	-25...+55
IP rating	IPX4	IPX4	IPX4
Motor IP rating	IP44	IP44	IP44
SEC class	B	B	B
ErP	2018	2018	2018

ISO-RB EC 100

Sound power level, A-weighted	Total	Octave frequency bands [Hz]								LpA 3 m	LpA 1 m
		63	125	250	500	1000	2000	4000	8000		
L _{WA} to inlet [dBA]	65	51	59	63	54	50	44	44	34	45	55
L _{WA} to outlet [dBA]	83	68	78	80	75	61	53	55	47	63	73
L _{WA} to environment [dBA]	57	42	47	53	53	44	43	42	41	37	47

ISO-RB EC 125

Sound power level, A-weighted	Total	Octave frequency bands [Hz]								LpA 3 m	LpA 1 m
		63	125	250	500	1000	2000	4000	8000		
L _{WA} to inlet [dBA]	66	51	60	64	55	51	44	44	34	46	56
L _{WA} to outlet [dBA]	85	70	80	82	77	63	54	57	48	65	75
L _{WA} to environment [dBA]	59	44	49	55	55	46	45	44	43	39	49

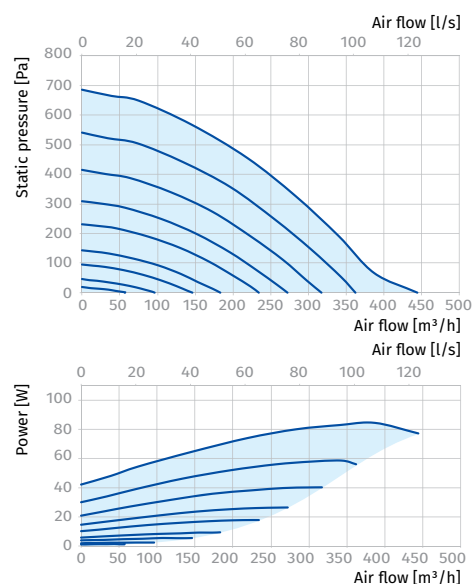
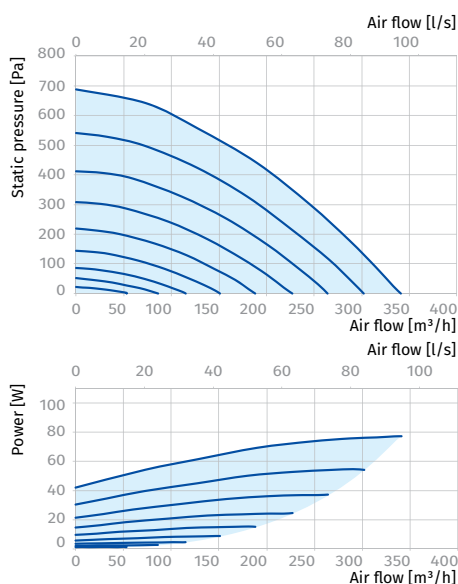
ISO-RB EC 150

Sound power level, A-weighted	Total	Octave frequency bands [Hz]								LpA 3 m	LpA 1 m
		63	125	250	500	1000	2000	4000	8000		
L _{WA} to inlet [dBA]	71	55	65	69	59	55	48	48	37	50	60
L _{WA} to outlet [dBA]	87	72	82	84	79	64	56	58	49	67	77
L _{WA} to environment [dBA]	60	43	51	58	53	43	42	40	40	40	50

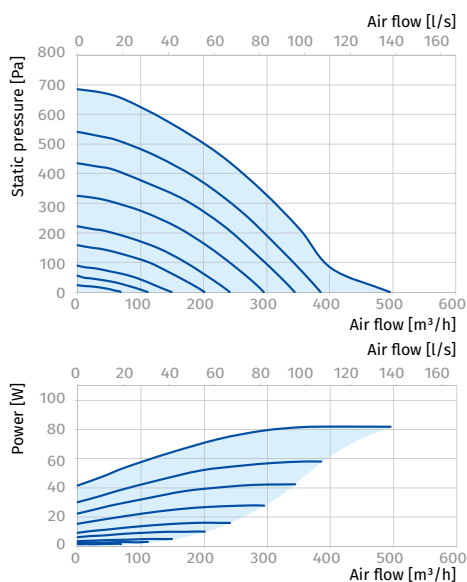

Parameters	Iso-RB EC 160	Iso-RB EC 200	Iso-RB EC 250	Iso-RB EC 315
Voltage [V/50 (60) Hz]	1 ~ 230	1 ~ 230	1 ~ 230	1 ~ 230
Power [W]	85	111	164	531
Current [A]	0.76	0.88	1.32	2.32
Maximum air flow [m³/h (l/s)]	454 (126)	740 (206)	1097 (305)	3053 (848)
RPM [min ⁻¹]	3600	2400	2800	2360
Sound pressure level at 3 m distance [dBA]	40	42	45	47
Transported air temperature [°C]	-25...+55	-25...+55	-25...+55	-25...+55
IP rating	IPX4	IPX4	IPX4	IPX4
Motor IP rating	IP44	IP44	IP44	IP54
SEC class	B	B	B	-
ErP	2018	2018	2018	2018

ISO-RB EC 160

Sound power level, A-weighted	Total	Octave frequency bands [Hz]								LpA 3 m	LpA 1 m
		63	125	250	500	1000	2000	4000	8000		
LWA to inlet [dBA]	70	55	64	68	59	54	47	47	37	50	60
LWA to outlet [dBA]	90	74	83	87	82	67	58	60	51	69	79
LWA to environment [dBA]	60	43	51	58	53	43	42	40	40	40	50

ISO-RB EC 200

Sound power level, A-weighted	Total	Octave frequency bands [Hz]								LpA 3 m	LpA 1 m
		63	125	250	500	1000	2000	4000	8000		
LWA to inlet [dBA]	70	54	64	68	58	54	47	47	36	49	59
LWA to outlet [dBA]	80	65	75	77	72	59	51	53	45	60	70
LWA to environment [dBA]	63	39	46	62	52	46	45	35	34	42	52

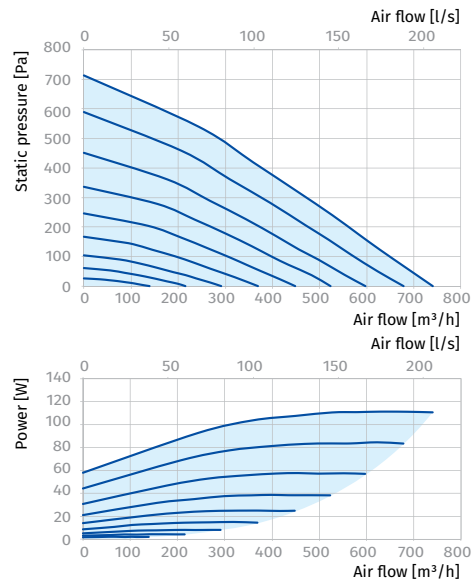
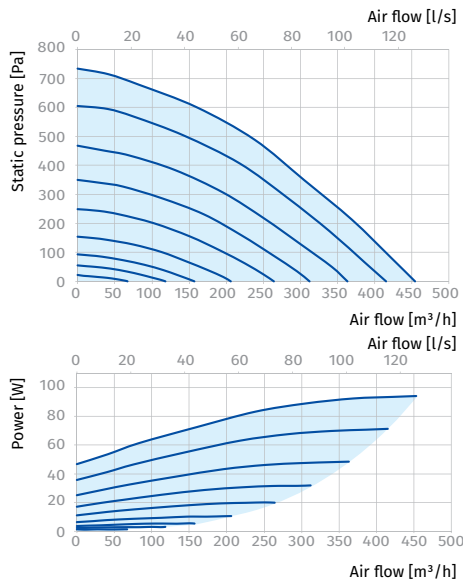

ISO-RB EC 250

Sound power level, A-weighted	Total	Octave frequency bands [Hz]								LpA 3 m	LpA 1 m
		63	125	250	500	1000	2000	4000	8000		
LWA to inlet [dBA]	77	60	70	75	64	59	52	52	40	56	66
LWA to outlet [dBA]	81	67	77	79	74	60	52	55	46	61	71
LWA to environment [dBA]	65	46	60	63	55	48	33	33	34	45	55

ISO-RB EC 315

Sound power level, A-weighted	Total	Octave frequency bands [Hz]								LpA 3 m	LpA 1 m
		63	125	250	500	1000	2000	4000	8000		
LWA to inlet [dBA]	84	77	80	79	75	68	64	62	60	64	74
LWA to outlet [dBA]	89	79	79	78	82	80	82	79	75	68	78
LWA to environment [dBA]	67	54	55	66	57	50	52	51	52	47	57

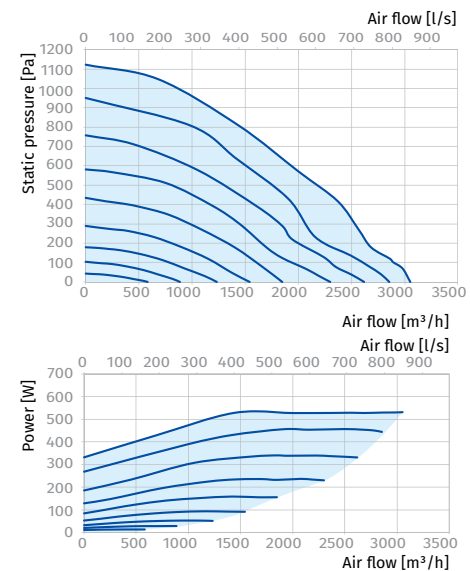
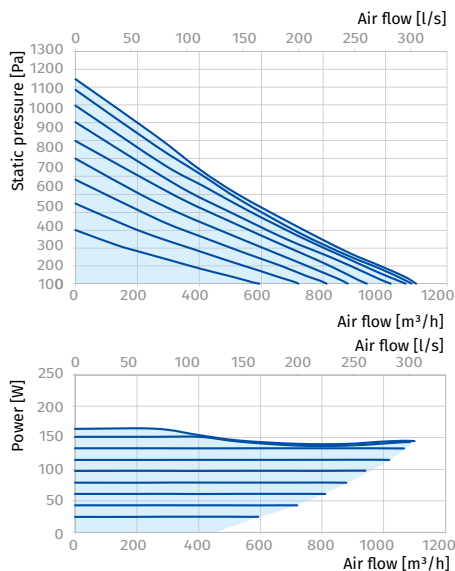

SOUND-INSULATED INLINE FANS

Parameters	Iso-RB EC 355	Iso-RB EC 400	Iso-RB EC 450	Iso-RB EC 500
Unit voltage [V/50 (60) Hz]	1 ~ 230	1 ~ 230	1 ~ 230	1 ~ 230
Power [W]	527	513	1200	752
Current [A]	2.31	2.25	1.95	3.42
Maximum air flow [m ³ /h (l/s)]	3417 (949)	3633 (1009)	5620 (1561)	7145 (1985)
RPM [min ⁻¹]	2360	2360	2580	1440
Sound pressure level at 3 m distance [dBA]	50	51	54	56
Transported air temperature [°C]	-25...+55	-25...+55	-25...+55	-25...+55
IP rating	IPX4	IPX4	IPX4	IPX4
Motor IP rating	IP54	IP54	IP54	IP54
SEC class	-	-	-	-
ErP	2018	2018	2018	2018

ISO-RB EC 355

Sound power level, A-weighted	Total	Octave frequency bands [Hz]								LpA 3 m	LpA 1 m
		63	125	250	500	1000	2000	4000	8000		
LWA to inlet [dBA]	89	82	85	84	80	72	68	66	64	69	79
LWA to outlet [dBA]	91	81	81	80	84	82	84	81	77	70	80
LWA to environment [dBA]	70	57	58	69	60	53	55	54	55	50	60

ISO-RB EC 400

Sound power level, A-weighted	Total	Octave frequency bands [Hz]								LpA 3 m	LpA 1 m
		63	125	250	500	1000	2000	4000	8000		
LWA to inlet [dBA]	86	67	79	84	72	67	58	58	45	65	75
LWA to outlet [dBA]	90	74	85	87	82	66	58	60	51	69	79
LWA to environment [dBA]	72	66	68	66	57	48	35	37	37	51	61

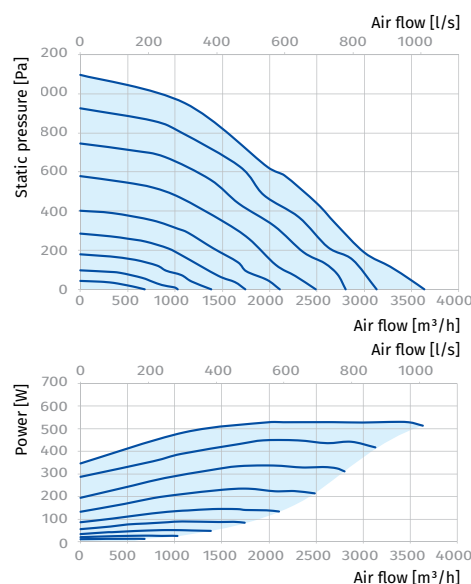
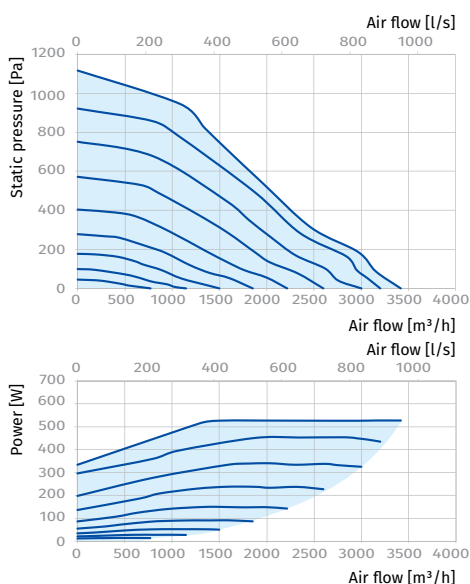
ISO-RB EC 450

Sound power level, A-weighted	Total	Octave frequency bands [Hz]								LpA 3 m	LpA 1 m
		63	125	250	500	1000	2000	4000	8000		
LWA to inlet [dBA]	85	66	78	83	71	66	57	57	44	64	74
LWA to outlet [dBA]	92	76	87	89	84	69	59	62	52	71	81
LWA to environment [dBA]	75	61	71	72	58	55	46	44	39	54	64

ISO-RB EC 500

Sound power level, A-weighted	Total	Octave frequency bands [Hz]								LpA 3 m	LpA 1 m
		63	125	250	500	1000	2000	4000	8000		
LWA to inlet [dBA]	88	69	81	86	74	68	59	59	46	67	77
LWA to outlet [dBA]	94	78	89	91	86	70	61	63	53	73	83
LWA to environment [dBA]	77	62	73	74	60	57	47	45	40	56	66

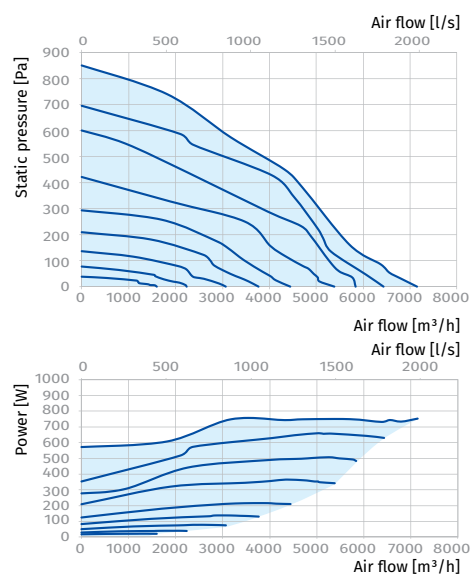
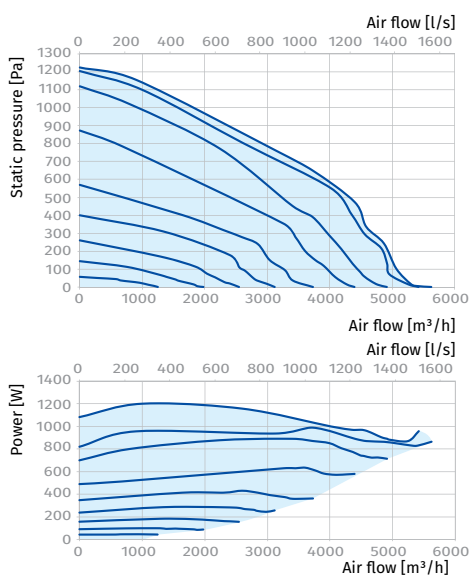

Iso-RF EC

Sound-insulated inline centrifugal fans

Use

- Supply and exhaust ventilation systems in premises with high requirements to the noise level and with limited space for mounting.
- Possibility of space-restricted installation above suspended ceilings.
- Compatible with Ø 100–250 mm air ducts.



Air flow:
up to 1682 m³/h
467 l/s



Power:
from 118 W



Noise level:
from 33 dBA

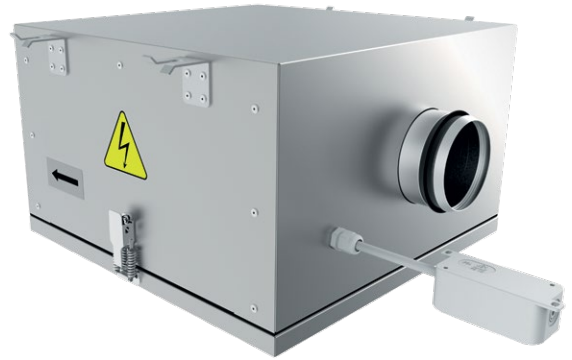

Design

- The fan casing is made of aluzinc.
- For easy installation and operation, the top cover of the fan is secured with a special lock.
- Heat- and sound insulation is made of non-combustible 50 mm mineral wool layer. To ensure better noise absorption, the inner surface of the insulation is made of a perforated metal sheet.
- The round connecting spigots are rubber sealed.



Speed control

- The fan speed is controlled with a 0–10 V control signal from the following sources:
 - integrated or external speed controller
 - controller with sensors
 - central BMS system.
- The control signal value changes depending on air temperature, pressure, smoke concentration and other parameters.
- During signal value change the fan with EC motor correspondingly changes the rotations speed and delivers required air volume to the ventilation system.
- The computer central building management systems (BMS) enable integration of several EC motors in network and precise individual operation control for each fan.

Mounting

- The fans are designed for connection to round air ducts. The fans are to be installed at an air duct junction.
- The use of flexible connectors requires fixation of the fan on the building structure by means of supports, mounts or fixing brackets.
- The fan can be fixed in any position with respect to the air flow direction indicated by the arrow on the fan casing. While mounting the fan provide enough access for servicing and repair operations.

Motor

- High-efficient direct current EC motor with external rotor and forward curved blades.
- EC technology meets the up-to-date requirements to energy-saving and controllable ventilation and provides up to 35 % energy saving as compared to asynchronous motors.
- EC motor ensures totally controllable speed range for the fan and has integrated overheating protection with automatic restart.
- EC motor has no friction and wearing parts as capacitor und brushes. Instead a maintenance-free EC controller electronic circuit board is used.
- The impeller is dynamically balanced.
- The fan is compatible with 50 Hz and 60 Hz power mains and the maximum speed does not depend on power mains frequency.

Designation key

Series	Motor	Duct diameter [mm]	Options
Iso-RF	EC: synchronous electronically commutated motor	100; 125; 150; 160; 200; 250	W1: power cable with mains plug

Accessories

Silencers	Filter boxes	Electric heaters	Water heaters	Backdraft air dampers	Air dampers	Speed controllers	Timers/Sensors
 SD	 KFBK / KFBT	 EKH	 WKH	 VRV	 VK / VKA	 CDT E/0-10	 TE(TI) / HSE(HSI) / LSE(LSI) / IRSE(IRSI)

Overall dimensions [mm]

Type	Ø D	B	B1	B2	H	L	L1	L2	Weight [kg]
Iso-RF EC 100	97	512	360	589	280	504	553	460	17
Iso-RF EC 125	122	512	360	589	280	504	553	460	17
Iso-RF EC 150	147	592	390	669	350	564	613	520	24
Iso-RF EC 160	157	592	390	669	350	564	613	520	24
Iso-RF EC 200	197	552	374	629	370	597	646	553	26
Iso-RF EC 250	247	665	487	742	405	650	699	606	33

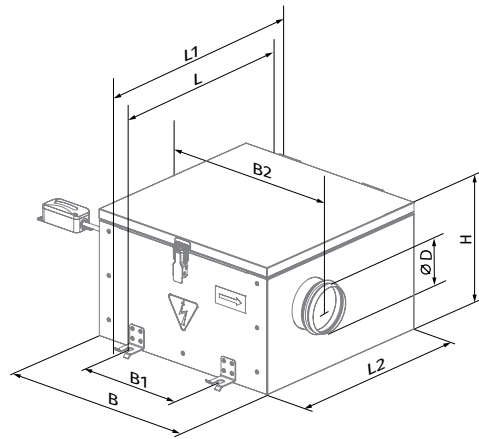

Technical data

Parameters	Iso-RF EC 100	Iso-RF EC 125	Iso-RF EC 150 Iso-RF EC 160
Voltage [V/50 (60) Hz]	1 ~ 230	1 ~ 230	1 ~ 230
Power [W]	118	118	220
Current [A]	0.92	0.92	0.59
Maximum air flow [m ³ /h (l/s)]	353 (98)	393 (109)	779 (216)
RPM [min ⁻¹]	3000	3000	2070
Sound pressure level at 3 m distance [dBA]	33	33	38
Transported air temperature [°C]	-25...+50	-25...+50	-25...+50
IP rating	IP44	IP44	IP44
Motor IP rating	IP54	IP54	IP54
SEC class	C	C	B
ErP	2018	2018	2018

ISO-RF EC 100

Sound power level, A-weighted	Total	Octave frequency bands [Hz]								LpA 3 m	LpA 1 m
		63	125	250	500	1000	2000	4000	8000		
L _{WA} to inlet [dBA]	69	61	61	64	60	58	58	56	52	48	58
L _{WA} to outlet [dBA]	73	55	65	67	67	63	65	60	56	52	62
L _{WA} to environment [dBA]	53	35	39	50	46	43	45	40	34	33	43

ISO-RF EC 125

Sound power level, A-weighted	Total	Octave frequency bands [Hz]								LpA 3 m	LpA 1 m
		63	125	250	500	1000	2000	4000	8000		
L _{WA} to inlet [dBA]	69	56	60	64	63	62	60	56	46	49	59
L _{WA} to outlet [dBA]	75	57	68	66	67	69	68	60	51	54	64
L _{WA} to environment [dBA]	54	17	35	43	44	50	49	41	30	33	43

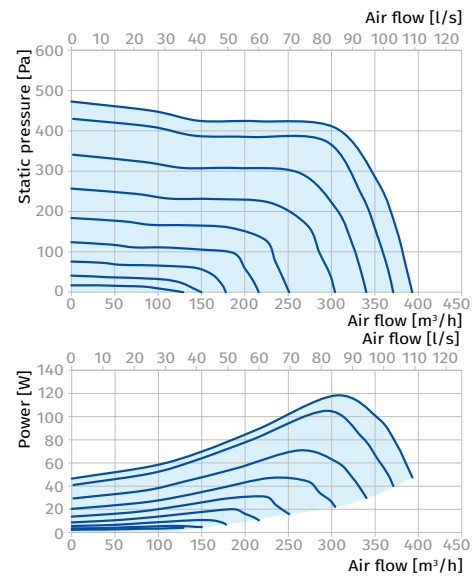
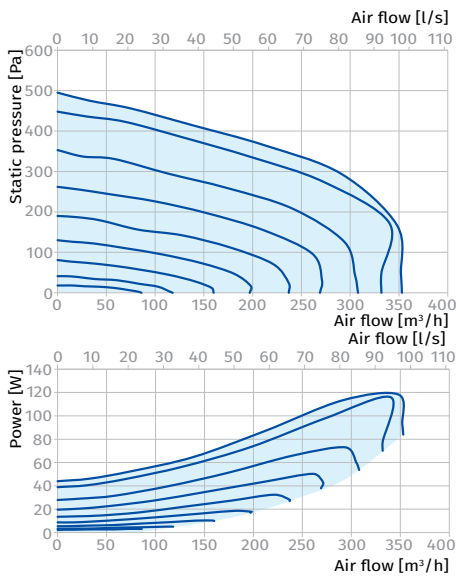
ISO-RF EC 150, ISO-RF EC 160

Sound power level, A-weighted	Total	Octave frequency bands [Hz]								LpA 3 m	LpA 1 m
		63	125	250	500	1000	2000	4000	8000		
L _{WA} to inlet [dBA]	76	62	71	70	68	66	64	62	56	55	65
L _{WA} to outlet [dBA]	80	60	71	74	73	72	68	60	59	59	69
L _{WA} to environment [dBA]	59	32	45	53	52	53	52	45	35	38	48

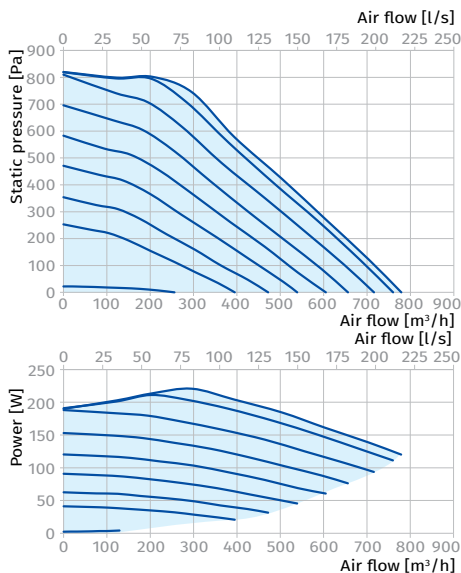

Parameters	Iso-RF EC 200	Iso-RF EC 250
Voltage [V/50 (60) Hz]	1 ~ 230	1 ~ 230
Power [W]	259	374
Current [A]	1.45	1.77
Maximum air flow [m³/h (l/s)]	1264 (351)	1682 (467)
RPM [min ⁻¹]	1600	1400
Sound pressure level at 3 m distance [dBA]	40	41
Transported air temperature [°C]	-25...+50	-25...+50
IP rating	IP44	IP44
Motor IP rating	IP54	IP54
SEC class	-	-
ErP	2018	2018

ISO-RF EC 200

Sound power level, A-weighted	Total	Octave frequency bands [Hz]								LpA 3 m	LpA 1 m
		63	125	250	500	1000	2000	4000	8000		
L _{WA} to inlet [dBA]	74	66	66	70	65	63	63	61	57	54	64
L _{WA} to outlet [dBA]	79	60	71	73	73	69	71	65	61	58	68
L _{WA} to environment [dBA]	60	40	45	58	53	49	52	46	39	40	50

ISO-RF EC 250

Sound power level, A-weighted	Total	Octave frequency bands [Hz]								LpA 3 m	LpA 1 m
		63	125	250	500	1000	2000	4000	8000		
L _{WA} to inlet [dBA]	79	65	75	74	71	69	67	65	59	59	69
L _{WA} to outlet [dBA]	83	62	74	77	76	75	75	71	62	62	72
L _{WA} to environment [dBA]	62	34	47	56	55	56	55	47	37	41	51

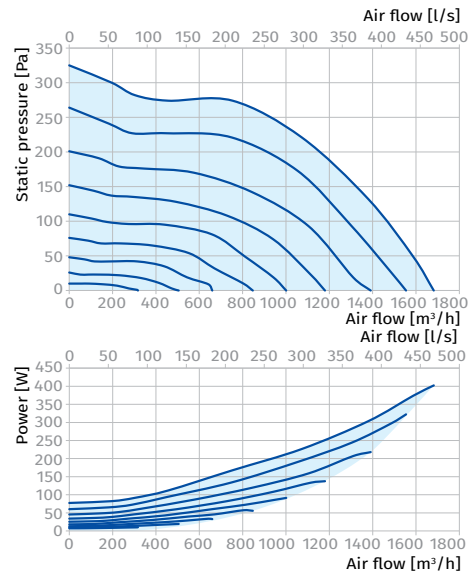
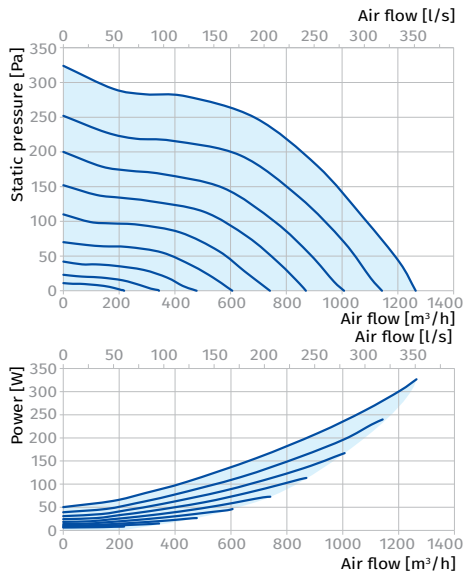

Iso-V

Sound-insulated inline centrifugal fans

Use

- Supply and extract ventilation systems installed in premises with high requirements to the noise level.
- Various application possibilities due to a special transformable casing design.
- Suitable for use as separate components of air handling systems.
- Compatible with \varnothing 355 up to 710 mm round or 500x500 up to 1000x1000 mm rectangular air ducts.



Air flow:
up to 16870 m³/h
4686 l/s



Power:
from 230 W



Noise level:
from 47 dBA



Design

- Casing made of aluminium frame and removable aluzinc thermal- and sound-insulated double-skinned sandwich panels.
- Casing internally filled with 20 mm non-flammable mineral wool.
- Position of the removable panels can be adjusted to inline air flow or 90° angle air flow.
- Due to corrosion-resistant casing and thermal insulation the fan is suitable for external mounting.
- Square to square vibration absorbing connectors (AKV series) or square to round connector-reducers (ARV series) may be connected to the fan (available upon separate order).
- The round spigot of the ARV connector-reducer is rubber sealed for air tight connection.

Motor

- Four- or six-pole asynchronous motor with external rotor and centrifugal impeller with backward curved blades.
- Single-phase (E) or three-phase (D) motor modifications.
- Equipped with ball bearings for longer service life.
- Overheating protection by built-in thermal switches with leaded outside terminals for connection to external protecting controls.
- The thermal switch terminal leads are designed for connection to respective circuit of the overload relay or respective terminals of the autotransformer or thyristor speed controller.
- The model Iso-V 355 4E incorporates thermal switches with automatic restart.
- Dynamically balanced impeller.

Speed control

- Smooth speed control with an external thyristor controller or step speed control with an external auto transformer (both available upon separate order).

Designation key

Series	Spigot diameter [mm]	Motor Number of poles	Phase		Motor modifications
			E: single-phase	D: three-phase	
Iso-V	355; 400; 450; 500; 560; 630; 710	4, 6	E: single-phase	D: three-phase	max: high-powered motor

Accessories

Speed controllers	Connecting reducers	Flexible connectors	Outer hoods	Protecting cover
CDT E1.8 / CDTE E1.8	ARV	AKV	AH-IV	RSD-IV

Mounting

- The fan is mounted with rectangular or round air ducts.
- Connected to air ducts with flexible vibration-absorbing connectors or connecting reducers of respective diameters.
- Power is supplied to the fan through an external terminal box.
- The fans can be installed in any mounting position with respect to air flow direction in the system. While mounting provide enough servicing space.
- In case of outdoor mounting the fan may be equipped with the upper protecting cover (RSD-IV series) or the outer hood (AH-IV series) to be installed at air inlet/outlet.

Modifications and options

- max: high-powered motor.

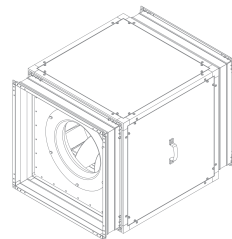

Iso-V fan with vibration-absorbing flexible connectors AKV series

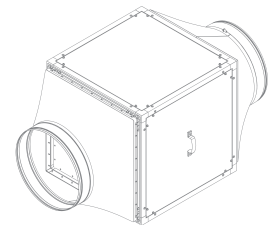

Iso-V fan with connecting reducers ARV series

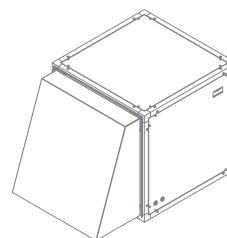

Iso-V fans with AH-IV outer hood

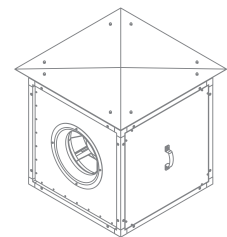

Iso-V fans with RSD-IV protecting cover

Fan and accessories overall dimensions

Type	Dimensions [mm]		Weight [kg]	Options			
	A			ARV connector-reducer	AKV vibration absorbing connector	RSD-IV protecting cover	AH-V outer hood
Iso-V 355 4E	500		25	ARV 355	AKV 500	RSD-IV 315-355	AH-IV 315-355
Iso-V 355 4D	500		25	ARV 355	AKV 500	RSD-IV 315-355	AH-IV 315-355
Iso-V 400 4E	670		39	ARV 400	AKV 670	RSD-IV 400-500	AH-IV 400-500
Iso-V 400 4D	670		39	ARV 400	AKV 670	RSD-IV 400-500	AH-IV 400-500
Iso-V 450 4E	670		43	ARV 450	AKV 670	RSD-IV 400-500	AH-IV 400-500
Iso-V 450 4D	670		43	ARV 450	AKV 670	RSD-IV 400-500	AH-IV 400-500
Iso-V 500 4E	670		52	ARV 500	AKV 670	RSD-IV 400-500	AH-IV 400-500
Iso-V 500 4D	670		56	ARV 500	AKV 670	RSD-IV 400-500	AH-IV 400-500
Iso-V 560 4D	800		99	ARV 560	AKV 800	RSD-IV 560-630	AH-IV 560-530
Iso-V 560 6D	800		86	ARV 560	AKV 800	RSD-IV 560-630	AH-IV 560-530
Iso-V 630 4D	800		102	ARV 630	AKV 800	RSD-IV 560-630	AH-IV 560-530
Iso-V 630 4D max	800		100	ARV 630	AKV 800	RSD-IV 560-630	AH-IV 560-530
Iso-V 630 6D	800		98	ARV 630	AKV 800	RSD-IV 560-630	AH-IV 560-530
Iso-V 710 6D	1000		136	ARV 710	AKV 1000	RSD-IV 710	AH-IV 710

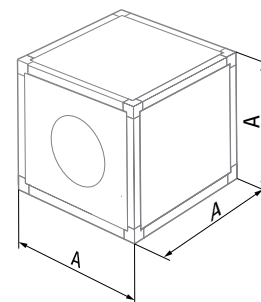

Iso-V

ARV

Type	Dimensions [mm]		
	A	B	∅ D
ARV 355	490	470	355
ARV 400	660	640	400
ARV 450	660	640	450
ARV 500	660	640	500
ARV 560	790	770	560
ARV 630	790	770	630
ARV 710	990	970	710

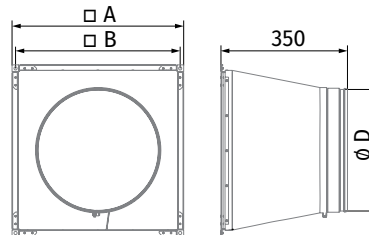

AKV

Type	Dimensions [mm]		
	A	B	C
AKV 500	490	470	445
AKV 670	660	640	615
AKV 800	790	770	745
AKV 1000	990	970	945

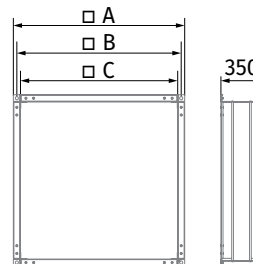

AH-IV

Type	Dimensions [mm]			Weight [kg]
	A	B	H	
AH-IV 315-355	478	458	225	3.2
AH-IV 400-500	648	628	321	6
AH-IV 560-630	778	758	421	9.1
AH-IV 710	978	958	421	12.0

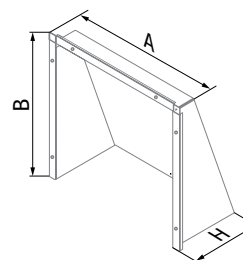

RSD-IV

Type	Dimensions [mm]	Weight [kg]
	A	
RSD-IV 315-355	600	2.3
RSD-IV 400-500	770	4.65
RSD-IV 560-630	900	7.65
RSD-IV 710	1100	11.4

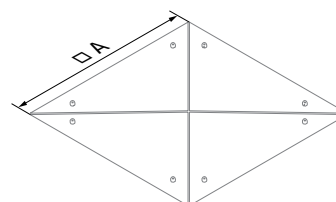

SOUND-INSULATED INLINE FANS

Technical data

Parameters	Iso-V 355 4E	Iso-V 355 4D		Iso-V 400 4E		Iso-V 400 4D			
Voltage [V]	1 ~ 230	3 ~ 400		1 ~ 230		3 ~ 400 Δ		3 ~ 400 Y	
Frequency [Hz]	50	50	60	50	60	50	60	50	60
Power [W]	245	230	235	480	700	515	750	385	515
Current [A]	1.12	0.52	0.53	2.4	3.15	1.41	1.44	0.7	0.93
Max. air flow at air flow direction [m³/h (l/s)]:									
- perpendicular air flow	2890 (803)	2660 (739)	2815 (782)	3750 (1042)	4310 (1197)	3950 (1097)	4310 (1197)	3340 (928)	3525 (979)
- direct air flow	2650 (736)	2380 (661)	2580 (717)	3535 (982)	4015 (1115)	3740 (1039)	4055 (1126)	3110 (864)	3290 (914)
RPM [min ⁻¹]	1420	1400	1600	1370	1460	1415	1610	1235	1220
Sound pressure level at 3 m [dBA]	54	53	55	51	52	51	53	47	49
Transported air temperature [°C]	-25...+50	-25...+70	-25...+65	-40...+80	-40...+55	-40...+60	-40...+60	-40...+80	-40...+40
IP rating	IPX4	IPX4		IPX4		IPX4		IPX4	
Motor IP rating	IP44	IP44		IP44		IP44		IP44	
ErP	2018	2018		2018		2018		2018	

ISO-V 355 4E

Sound power level, A-weighted	Total	Octave frequency bands [Hz]							
		63	125	250	500	1000	2000	4000	8000
L _{WA} to inlet [dBA]	70	55	58	61	63	62	60	52	47
L _{WA} to outlet [dBA]	68	57	59	62	65	63	62	55	47
L _{WA} to environment [dBA]	62	51	51	54	58	55	55	48	40

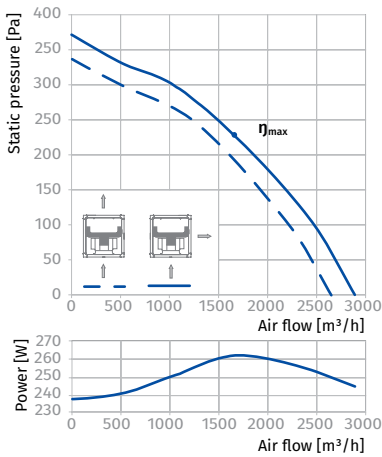

ISO-V 355 4D

Sound power level, A-weighted	Total	Octave frequency bands [Hz]							
		63	125	250	500	1000	2000	4000	8000
L _{WA} to inlet [dBA]	68	54	57	61	63	62	59	52	46
L _{WA} to outlet [dBA]	70	55	61	61	65	66	59	54	47
L _{WA} to environment [dBA]	64	49	50	55	59	56	52	49	39

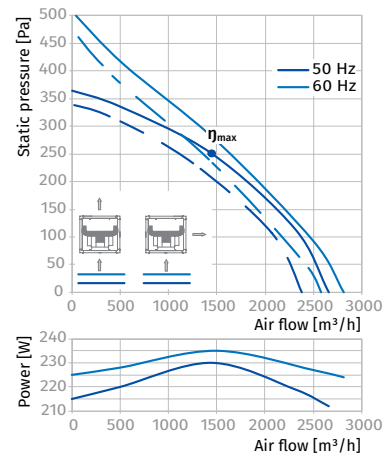

ISO-V 400 4E

Sound power level, A-weighted	Total	Octave frequency bands [Hz]							
		63	125	250	500	1000	2000	4000	8000
L _{WA} to inlet [dBA]	72	60	62	66	66	64	65	58	51
L _{WA} to outlet [dBA]	74	61	63	68	71	68	67	58	53
L _{WA} to environment [dBA]	56	43	47	47	52	49	48	42	33

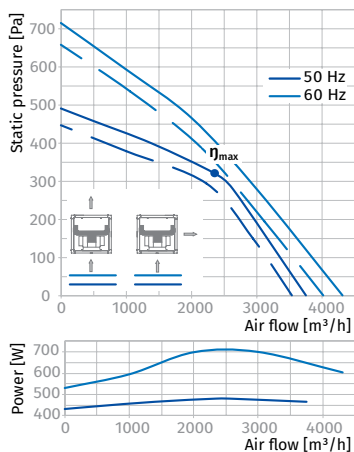

ISO-V 400 4D

Sound power level, A-weighted	Total	Octave frequency bands [Hz]							
		63	125	250	500	1000	2000	4000	8000
L _{WA} to inlet [dBA]	73	57	63	64	67	68	62	59	52
L _{WA} to outlet [dBA]	74	60	63	65	69	66	67	61	51
L _{WA} to environment [dBA]	54	43	44	49	50	51	47	42	36

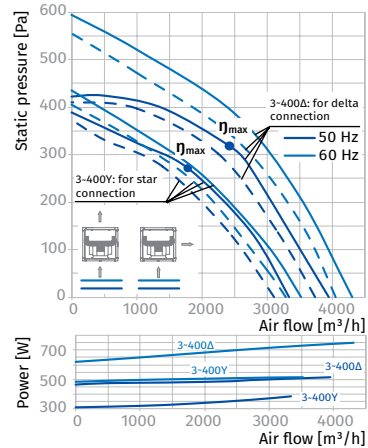

Parameters	Iso-V 450 4E	Iso-V 450 4D	Iso-V 500 4E	Iso-V 500 4D
Voltage [V]	1 ~ 230	3 ~ 400	1 ~ 230	3 ~ 400
Frequency [Hz]	50	50	50	50
Power [W]	680	740	1300	1430
Current [A]	3	1.5	5.70	3.00
Max. air flow at air flow direction [m³/h (l/s)]:				
- perpendicular air flow	5630 (1564)	5700 (1583)	7330 (2036)	7940 (2206)
- direct air flow	4930 (1370)	5080 (1411)	6680 (1856)	7200 (2000)
RPM [min ⁻¹]	1250	1350	1320	1375
Sound pressure level at 3 m [dBA]	53	54	55	58
Transported air temperature [°C]	-40...+70	-40...+80	-20...+50	-40...+80
IP rating	IPX4	IPX4	IPX4	IPX4
Motor IP rating	IP44	IP44	IP44	IP44
ErP	2018	2018	-	-

ISO-V 450 4E

Sound power level, A-weighted	Total	Octave frequency bands [Hz]							
		63	125	250	500	1000	2000	4000	8000
LWA to inlet [dBA]	76	62	64	67	68	69	66	63	53
LWA to outlet [dBA]	76	63	66	70	71	69	66	63	57
LWA to environment [dBA]	57	44	48	52	56	53	50	47	38

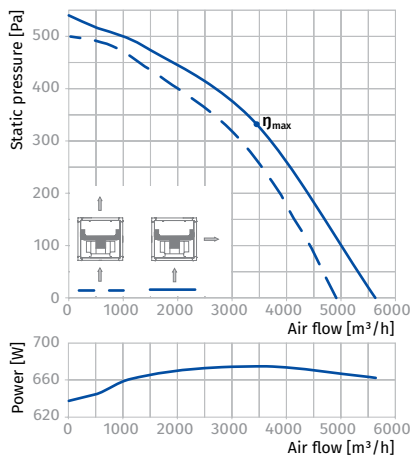

ISO-V 450 4D

Sound power level, A-weighted	Total	Octave frequency bands [Hz]							
		63	125	250	500	1000	2000	4000	8000
LWA to inlet [dBA]	76	61	65	67	68	68	66	50	55
LWA to outlet [dBA]	75	63	67	69	70	72	68	63	54
LWA to environment [dBA]	61	46	47	52	52	51	51	44	36

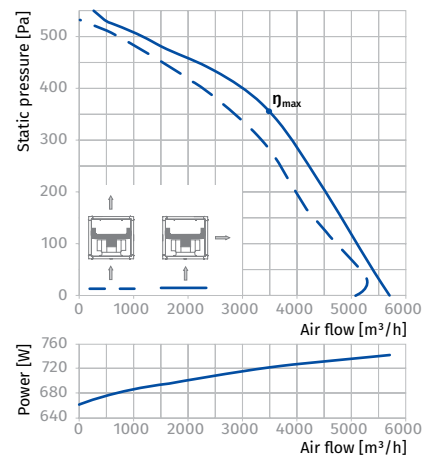

ISO-V 500 4E

Sound power level, A-weighted	Total	Octave frequency bands [Hz]							
		63	125	250	500	1000	2000	4000	8000
LWA to inlet [dBA]	81	65	70	73	74	75	69	65	57
LWA to outlet [dBA]	81	68	72	74	76	75	71	69	61
LWA to environment [dBA]	65	52	53	56	57	56	55	51	40

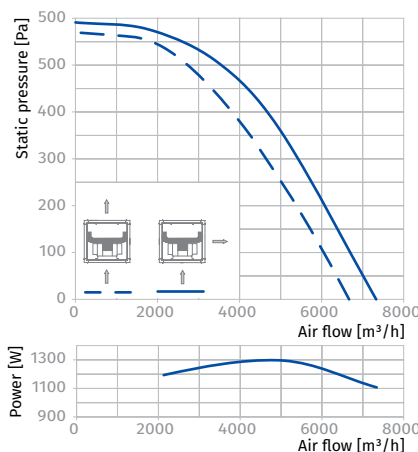

ISO-V 500 4D

Sound power level, A-weighted	Total	Octave frequency bands [Hz]							
		63	125	250	500	1000	2000	4000	8000
LWA to inlet [dBA]	77	66	67	71	71	74	71	65	55
LWA to outlet [dBA]	79	69	67	73	76	74	73	68	59
LWA to environment [dBA]	61	52	54	54	56	55	54	51	44

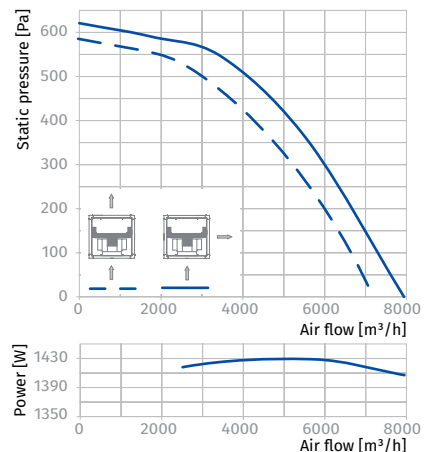

SOUND-INSULATED INLINE FANS

Parameters	Iso-V 560 4D	Iso-V 560 6D	Iso-V 630 4D	Iso-V 630 4D max
Voltage [V]	3 ~ 400	3 ~ 400	3 ~ 400	3 ~ 400
Frequency [Hz]	50	50	50	50
Power [W]	2380	780	3310	4250
Current [A]	5.00	1.70	6.20	7.55
Max. air flow at air flow direction [m³/h (l/s)]:				
- perpendicular air flow	11340 (3150)	7970 (2214)	15170 (4214)	16870 (4686)
- direct air flow	10490 (2914)	7330 (2036)	13740 (3817)	14930 (4148)
RPM [min ⁻¹]	1365	885	1170	1300
Sound pressure level at 3 m [dBA]	56	49	67	69
Transported air temperature [°C]	-40...+60	-40...+55	-40...+35	-40...+60
IP rating	IPX4	IPX4	IPX4	IPX4
Motor IP rating	IP44	IP44	IP44	IP44
ErP	-	2018	-	-

ISO-V 560 4D

Sound power level, A-weighted	Total	Octave frequency bands [Hz]							
		63	125	250	500	1000	2000	4000	8000
LWA to inlet [dBA]	80	66	67	73	75	73	69	67	58
LWA to outlet [dBA]	80	67	71	73	77	74	73	65	61
LWA to environment [dBA]	63	53	55	59	57	60	53	49	41

ISO-V 560 6D

Sound power level, A-weighted	Total	Octave frequency bands [Hz]							
		63	125	250	500	1000	2000	4000	8000
LWA to inlet [dBA]	72	59	57	64	67	67	62	56	49
LWA to outlet [dBA]	70	58	61	66	68	65	65	60	51
LWA to environment [dBA]	56	44	43	48	52	50	46	41	33

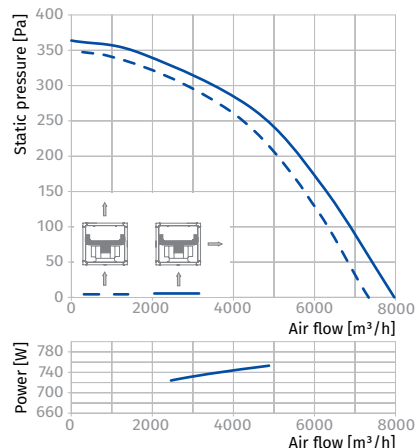
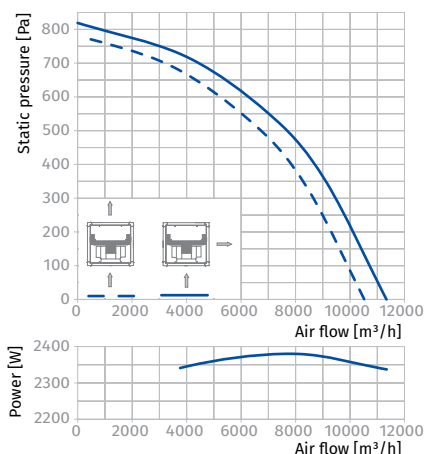

ISO-V 630 4D

Sound power level, A-weighted	Total	Octave frequency bands [Hz]							
		63	125	250	500	1000	2000	4000	8000
LWA to inlet [dBA]	85	76	78	80	80	83	78	75	68
LWA to outlet [dBA]	88	76	76	84	86	82	78	77	67
LWA to environment [dBA]	76	64	65	67	73	68	69	62	53

ISO-V 630 4D MAX

Sound power level, A-weighted	Total	Octave frequency bands [Hz]							
		63	125	250	500	1000	2000	4000	8000
LWA to inlet [dBA]	85	76	77	81	83	82	77	72	68
LWA to outlet [dBA]	89	77	78	81	85	84	80	73	68
LWA to environment [dBA]	78	65	65	70	71	70	69	62	54

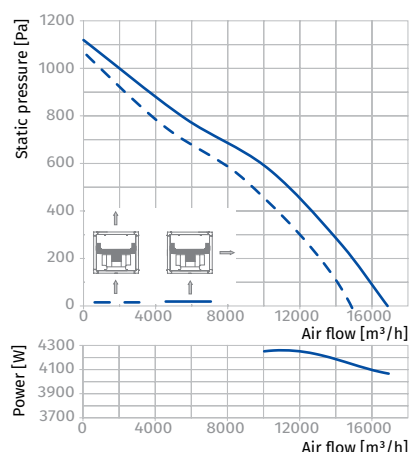
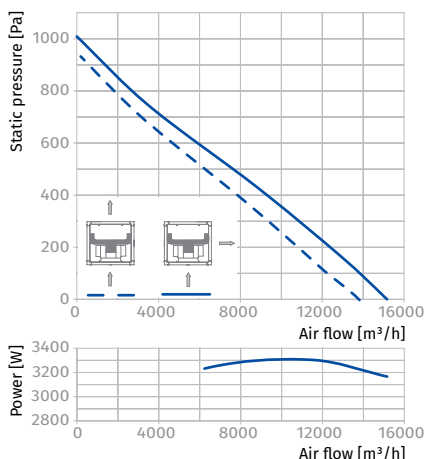

Parameters	Iso-V 630 6D	Iso-V 710 6D
Voltage [V]	3 ~ 400	3 ~ 400
Frequency [Hz]	50	50
Power [W]	1310	2000
Current [A]	2.80	3.90
Max. air flow at air flow direction [m³/h (l/s)]:		
- perpendicular air flow	12030 (3342)	15830 (4398)
- direct air flow	10440 (2900)	14880 (4134)
RPM [min ⁻¹]	880	890
Sound pressure level at 3 m [dBA]	55	59
Transported air temperature [°C]	-40...+60	-20...+40
IP rating	IPX4	IPX4
Motor IP rating	IP44	IP44
ErP	-	2018

ISO-V 630 6D

Sound power level, A-weighted	Total	Octave frequency bands [Hz]							
		63	125	250	500	1000	2000	4000	8000
L _{WA} to inlet [dBA]	74	61	63	70	70	69	64	60	50
L _{WA} to outlet [dBA]	76	65	64	71	73	69	68	60	54
L _{WA} to environment [dBA]	61	50	51	53	56	56	52	47	40

ISO-V 710 6D

Sound power level, A-weighted	Total	Octave frequency bands [Hz]							
		63	125	250	500	1000	2000	4000	8000
L _{WA} to inlet [dBA]	79	64	66	71	74	72	71	67	58
L _{WA} to outlet [dBA]	80	67	70	76	74	76	72	67	57
L _{WA} to environment [dBA]	68	53	58	61	64	62	56	53	47

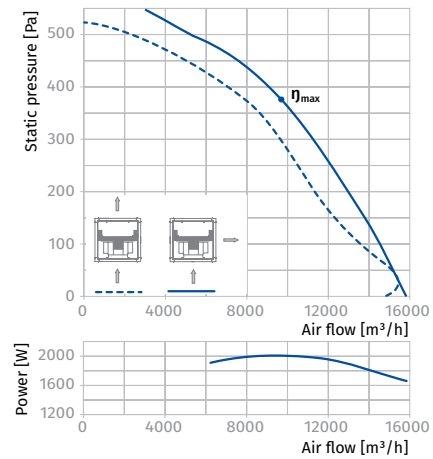
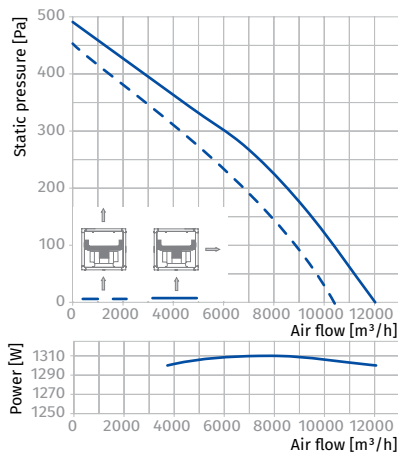

Iso-V EC

Sound-insulated inline fans with EC motor

Use

- Supply and extract ventilation systems installed in premises with high requirements to the noise level.
- A perfect solution for various ventilation system configurations due to a special transformable casing design.
- Suitable for use as a component of a modular air handling unit.
- For arranging energy-saving and controllable ventilation systems.
- Compatible with Ø 315 up to 630 mm round air ducts or 500x500 up to 800x800 mm rectangular air ducts.



Air flow:
up to 16740 m³/h
4650 l/s



Power:
from 150 W



Noise level:
from 35 dBA



Design

- Casing made of aluminium frame and removable aluzinc thermal and sound-insulated double-skinned sandwich panels.
- Casing internally filled with 20 mm non-flammable mineral wool.
- Position of the removable panels can be adjusted to inline air flow or 90° angle air flow.
- Due to corrosion-resistant and thermally insulated casing the fan is suitable for external use.
- The fan is compatible with square to square vibration absorbing connectors (AKV series) or square to round connector-reducers (ARV series), both available upon separate order.
- The round spigot of the ARV connector-reducer is rubber sealed for air tight connection.

Motor

- High-efficient direct current EC motor with external rotor and backward curved blades.
- EC technology meets the up-to-date requirements to energy-saving and controllable ventilation and provides up to 35 % energy saving as compared to asynchronous motors.
- EC motor ensures totally controllable speed range for the fan and has integrated overheating protection with automatic restart.
- EC motor has no friction and wearing parts as capacitor and brushes. Instead a maintenance-free EC controller electronic circuit board is used.
- The impeller is dynamically balanced.
- The fan is compatible with 50 Hz and 60 Hz power mains and the maximum speed does not depend on power mains frequency.

Operation and speed control

- The fan speed is controlled with a 0–10 V control signal from the following sources:
 - integrated or external speed controller
 - controller with sensors
 - central BMS system.

- The control signal value changes depending on air temperature, pressure, smoke concentration and other parameters.
- During signal value change the fan with EC motor correspondingly changes the rotations speed and delivers required air volume to the ventilation system.
- The computer central building management systems (BMS) enable integration of several EC motors in network and precise individual operation control for each fan.

Mounting

- Compatible both with square and round air ducts.
- Connection to air ducts through flexible vibration absorbing connectors or connector-reducers of a matching section.
- External terminal box for connection to power mains.
- Mounting in any position in compliance with the air flow direction. Maintenance space must be provided.
- In case of outdoor mounting the fan may be equipped with the upper protecting cover (RSD-IV series) or the outer hood (AH-IV series) to be installed at air inlet/outlet.

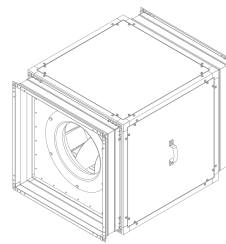

Iso-V EC fan with vibration-absorbing flexible connectors AKV series

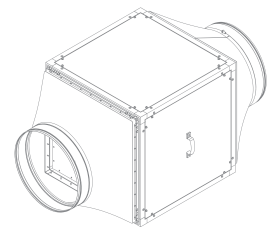

Iso-V EC fan with connecting reducers ARV series

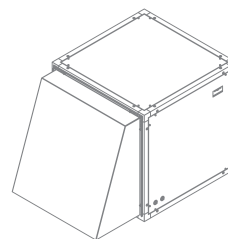

Iso-V EC fans with AH-IV outer hood

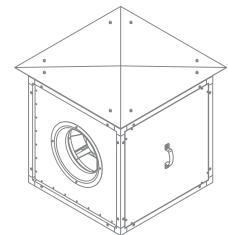

Iso-V EC fans with RSD-IV protecting cover

Designation key

Series	Motor type	Spigot diameter [mm]
Iso-V	EC: electronically commutated motor	315; 355; 400; 450; 500; 560; 630

Accessories

Connecting reducers	Flexible connectors	Outer hoods	Protecting cover	Speed controllers
---------------------	---------------------	-------------	------------------	-------------------

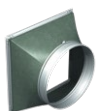

ARV

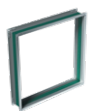

AKV



AH-IV



RSD-IV



CDT E/0-10

Fan and accessories overall dimensions

Type	Dimensions [mm]		Weight [kg]	Options			
	A			ARV connector-reducer	AKV vibration absorbing connector	RSD-IV protecting cover	AH-IV outer hood
Iso-V EC 315	500		25	ARV 315	AKV 500	RSD-IV 315-355	AH-IV 315-355
Iso-V EC 355	500		29	ARV 355	AKV 500	RSD-IV 315-355	AH-IV 315-355
Iso-V EC 400	670		42	ARV 400	AKV 670	RSD-IV 400-500	AH-IV 400-500
Iso-V EC 450	670		46	ARV 450	AKV 670	RSD-IV 400-500	AH-IV 400-500
Iso-V EC 500	670		50	ARV 500	AKV 670	RSD-IV 400-500	AH-IV 400-500
Iso-V EC 560	800		60	ARV 560	AKV 800	RSD-IV 560-630	AH-IV 560-630
Iso-V EC 630	800		69	ARV 630	AKV 800	RSD-IV 560-630	AH-IV 560-630

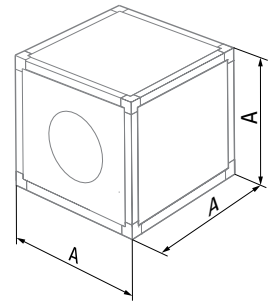

Iso-V EC

ARV

Type	Dimensions [mm]		
	A	B	∅ D
ARV 315	490	470	315
ARV 355	490	470	355
ARV 400	660	640	400
ARV 450	660	640	450
ARV 500	660	640	500
ARV 560	790	770	560
ARV 630	790	770	630

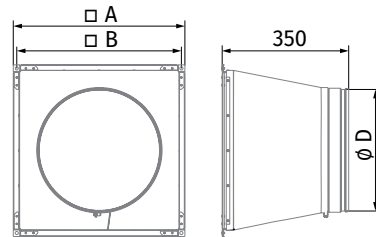

AKV

Type	Dimensions [mm]		
	A	B	C
AKV 500	490	470	445
AKV 670	660	640	615
AKV 800	790	770	745

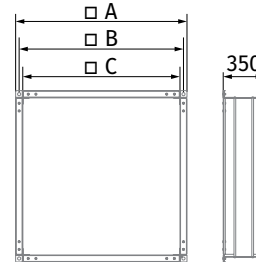

AH-IV

Type	Dimensions [mm]			Weight [kg]
	A	B	H	
AH-IV 315-355	478	458	225	3.2
AH-IV 400-500	648	628	321	6
AH-IV 560-630	778	758	421	9.1

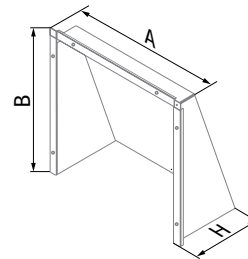

RSD-IV

Type	Dimensions [mm]		Weight [kg]
	A		
RSD-IV 315-355	600		2.3
RSD-IV 400-500	770		4.65
RSD-IV 560-630	900		7.65

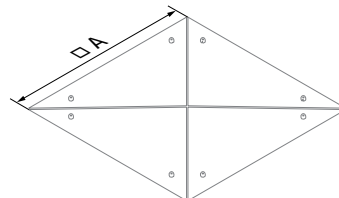

Technical data

Parameters	Iso-V EC 315	Iso-V EC 355	Iso-V EC 400
Voltage [V]	1 ~ 230	1 ~ 230	1 ~ 230
Frequency [Hz]	50/60	50/60	50/60
Power [W]	150	250	500
Current [A]	1.23	1.1	2.2
Max. air flow at air flow direction [m³/h (l/s)]: - perpendicular air flow - direct air flow	2370 (658) 2252 (626)	3830 (1064) 3639 (1011)	5660 (1572) 5377 (1494)
RPM [min ⁻¹]	1600	1450	1500
Sound pressure level at 3 m [dBA]	35	44	39
Transported air temperature [°C]	-40...+80	-25...+60	-25...+50
IP rating	IPX4	IPX4	IPX4
Motor IP rating	IP54	IP54	IP54
ErP	2018	2018	2018

Power [W]

Point	Iso-V EC 315	Iso-V EC 355	Iso-V EC 400	Iso-V EC 450	Iso-V EC 500	Iso-V EC 560	Iso-V EC 630
1	115	250	500	574	1215	1840	1779
2	137	250	500	750	1320	2296	2509
3	150	250	500	750	1320	2360	2750
4	137	250	500	750	1320	2313	2651
5	77	121	277	337	630	1240	1060
6	102	164	383	458	823	1672	1495
7	118	185	424	557	929	1736	1648
8	102	158	382	502	795	1669	1584
9	37	73	153	178	364	601	581
10	50	99	212	242	476	811	819
11	57	112	235	294	538	842	902
12	50	96	212	265	460	810	868
13	14	40	74	79	187	231	273
14	19	54	102	107	244	312	385
15	22	61	113	130	275	324	425
16	19	53	102	117	236	311	408

ISO-V EC 315

Sound power level, A-weighted	Total	Octave frequency bands [Hz]							
		63	125	250	500	1000	2000	4000	8000
LWA to inlet [dBA]	69	37	64	58	64	62	57	56	48
LWA to outlet [dBA]	73	49	71	62	65	65	60	56	47
LWA to environment [dBA]	56	29	52	46	49	49	45	34	27

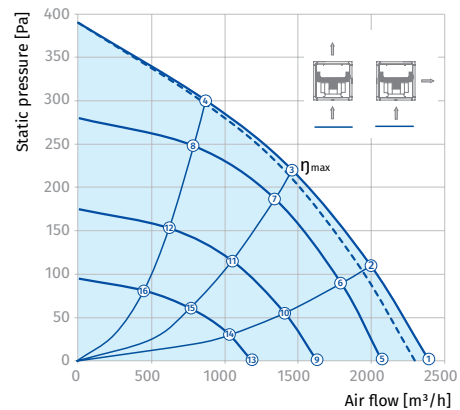

ISO-V EC 355

Sound power level, A-weighted	Total	Octave frequency bands [Hz]							
		63	125	250	500	1000	2000	4000	8000
LWA to inlet [dBA]	76	44	65	66	71	67	69	67	58
LWA to outlet [dBA]	77	44	70	67	71	71	70	67	59
LWA to environment [dBA]	64	61	54	53	55	52	54	51	36

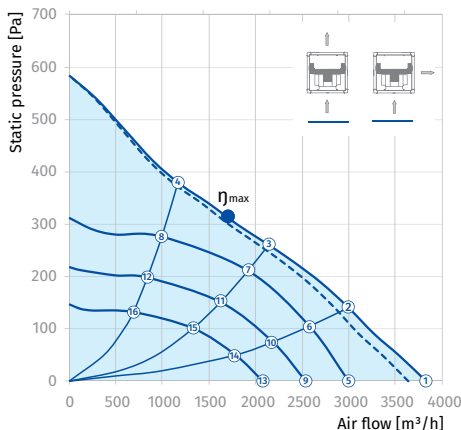

ISO-V EC 400

Sound power level, A-weighted	Total	Octave frequency bands [Hz]							
		63	125	250	500	1000	2000	4000	8000
LWA to inlet [dBA]	71	42	61	62	66	66	63	60	51
LWA to outlet [dBA]	75	50	68	64	68	69	66	61	53
LWA to environment [dBA]	60	32	52	53	49	55	52	44	31

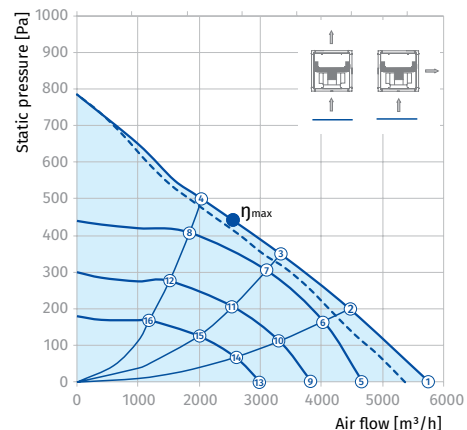

Parameters	Iso-V EC 450	Iso-V EC 500	Iso-V EC 560	Iso-V EC 630
Voltage [V]	1 ~ 230	3 ~ 400	3 ~ 400	3 ~ 400
Frequency [Hz]	50/60	50/60	50/60	50/60
Power [W]	750	1320	2360	2750
Current [A]	3.3	2.1	3.65	4.3
Max. air flow at air flow direction [m³/h (l/s)]:				
- perpendicular air flow	6800 (1889)	10450 (2903)	13600 (3778)	16740 (4650)
- direct air flow	6460 (1795)	9928 (2758)	12920 (3589)	15903 (4418)
RPM [min ⁻¹]	1440	1350	1540	1300
Sound pressure level at 3 m [dBA]	50	45	50	50
Transported air temperature [°C]	-25...+60	-25...+50	-25...+60	-25...+55
IP rating	IPX4	IPX4	IPX4	IPX4
Motor IP rating	IP54	IP54	IP54	IP54
ErP	2018	2018	2018	2018

ISO-V EC 450

Sound power level, A-weighted	Total	Octave frequency bands [Hz]							
		63	125	250	500	1000	2000	4000	8000
LWA to inlet [dBA]	79	48	70	71	73	72	70	65	62
LWA to outlet [dBA]	83	70	76	72	76	78	75	69	64
LWA to environment [dBA]	71	33	68	63	61	61	58	53	44

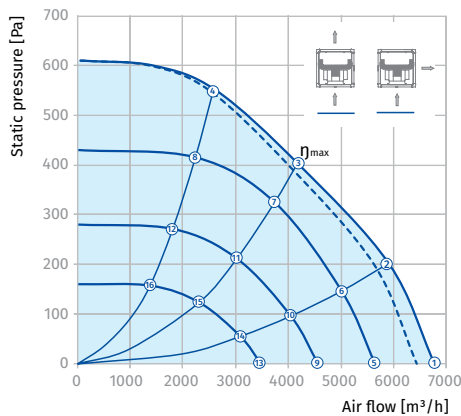

ISO-V EC 500

Sound power level, A-weighted	Total	Octave frequency bands [Hz]							
		63	125	250	500	1000	2000	4000	8000
LWA to inlet [dBA]	78	49	71	69	73	70	70	66	61
LWA to outlet [dBA]	81	51	70	71	76	75	72	68	64
LWA to environment [dBA]	66	36	54	62	60	57	57	52	40

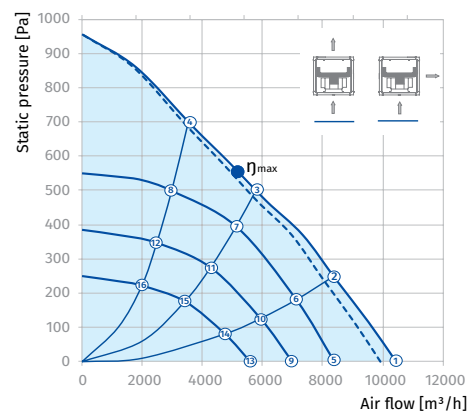

ISO-V EC 560

Sound power level, A-weighted	Total	Octave frequency bands [Hz]							
		63	125	250	500	1000	2000	4000	8000
LWA to inlet [dBA]	82	52	72	77	74	77	73	68	64
LWA to outlet [dBA]	78	58	70	71	72	72	67	65	59
LWA to environment [dBA]	71	41	67	63	63	61	60	50	40

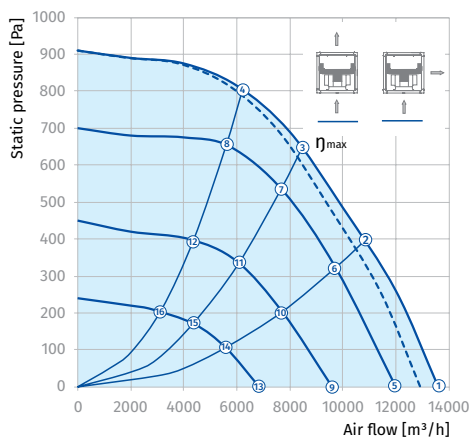

ISO-V EC 630

Sound power level, A-weighted	Total	Octave frequency bands [Hz]							
		63	125	250	500	1000	2000	4000	8000
LWA to inlet [dBA]	82	52	72	77	74	77	73	68	64
LWA to outlet [dBA]	78	58	70	71	72	72	67	65	59
LWA to environment [dBA]	71	41	67	63	63	61	60	50	40

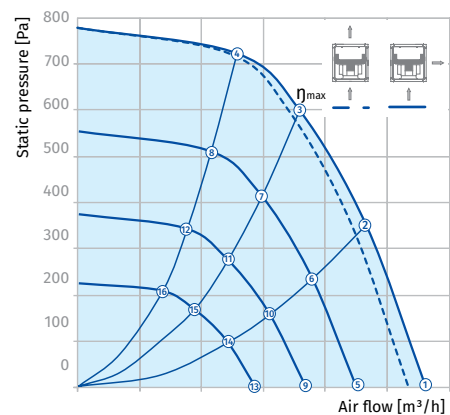

Iso-ZS

Sound-insulated inline centrifugal fans

Use

- Supply and extract ventilation systems installed in premises with high requirements to the noise level.
- Compatible with Ø 250 or 315 mm round air ducts.



Air flow:
up to 3930 m³/h
1092 l/s



Power:
from 120 W



Noise level:
from 40 dBA

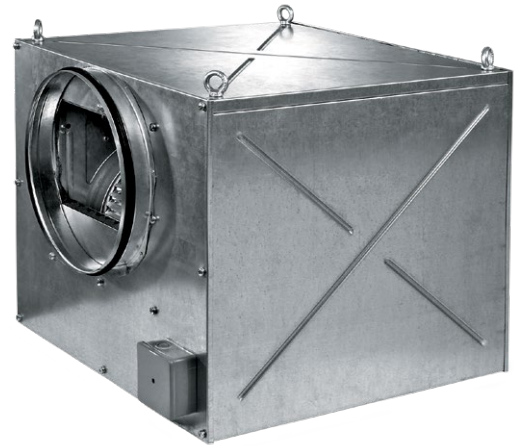

Design

- Galvanized steel casing internally filled with 30 mm thermal- and sound-insulating layer made of non-flammable foamed polyurethane.
- The connection spigots are equipped with rubber seals.
- External terminal block for power supply.
- Lifting lugs facilitate hanging and transportation operations.
- Modifications with two Ø 250 mm suction spigots are available specifically for multi-port ventilation solutions (**Iso-ZS 315/2x250**).



Motor

- Four- or six-pole asynchronous motor with external rotor and double intake centrifugal impeller with forward curved blades.
- The motor is installed on specially designed vibration-damping mounts to absorb vibration and noise.
- Equipped with ball bearings for longer service life.
- Integrated thermal protection with automatic restart.
- Dynamically balanced impeller.

Speed control

- Smooth speed control with an external thyristor controller or step speed control with an external auto transformer (both available upon separate order).

Mounting

- Mounted with round air ducts.
- Suitable for installation in any mounting position with respect to air flow direction in the system, fixed with supports or brackets.
- Suspended to ceiling with mounting lugs.
- Flexible air ducts are fixed on the fan spigots with clamps.

Modifications and options

- max:** high-powered motor.
- G1:** speed controller, temperature controller with external temperature sensor (cable length 4 m), power cable with mains plug.
- G1I:** speed controller, temperature controller with integrated temperature sensor and power cable with mains plug.
- The **G1** and **G1I** modifications enable automatic speed control depending on indoor temperature. The optimal ventilation solution for premises requiring permanent temperature control as greenhouses, orangeries, etc.
- W1:** power cable with mains plug.

SOUND-INSULATED INLINE FANS

Accessories

Silencers	Filter boxes	Electric heaters	Water heaters	Backdraft air dampers	Air dampers	Speed controllers	Timers/Sensors
SD	KFBK / KFBT	EKH	WKH	VRV	VK / VKA	CDT E1.8	TE(TI) / HSE(HSI) / LSE(LSI) / IRSE(IRSI)

Designation key							
Series	Flange diameter		Intake flange diameter*	Motor		Motor modifications	Options
	Exhaust flange diameter	Number of intake flanges		Number of poles	Phase		
Iso-ZS	250; 315	/ 2	x 250	4; 6	E: single-phase	max: high-powered motor	G1: speed controller, temperature controller with external temperature sensor, power cable with mains plug G11: speed controller, temperature controller with integrated temperature sensor and power cable mains plug W1: power cable with mains plug

* no intake flange diameter if it is equal to the exhaust flange diameter

Overall dimensions [mm]

Type	∅ D	∅ D1	∅ d	B	B1	H	H2	L	L1	L2	Weight [kg]
Iso-ZS 250 4E	248	-	20	453	400	433	470	568	470	400	30
Iso-ZS 250 6E	248	-	20	453	400	433	470	568	470	400	30
Iso-ZS 250 4E max	248	-	20	503	450	483	520	638	540	470	31.3
Iso-ZS 250 6E max	248	-	20	503	450	483	520	638	540	470	31.3
Iso-ZS 315 4E	313	-	20	600	550	500	537	680	580	510	33
Iso-ZS 315 6E	313	-	20	600	550	500	537	680	580	510	31
Iso-ZS 315 4E max	313	-	20	650	610	530	567	735	635	570	38
Iso-ZS 315 6E max	313	-	25	670	620	610	658	825	725	660	45
Iso-ZS 315/2x250 4E	313	248	20	600	-	500	537	680	580	510	33
Iso-ZS 315/2x250 6E	313	248	20	600	-	500	537	680	580	510	31
Iso-ZS 315/2x250 4E max	313	248	20	650	-	530	567	735	635	570	38
Iso-ZS 315/2x250 6E max	313	248	25	670	-	610	658	825	725	660	45

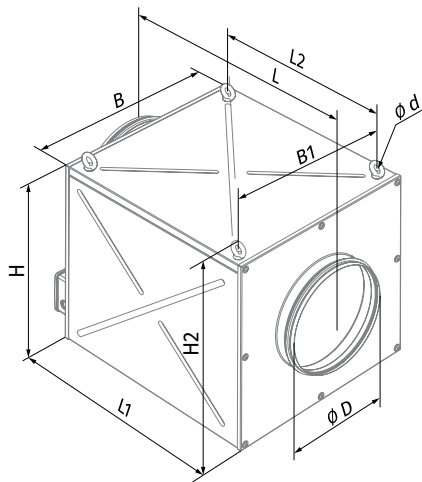

Iso-ZS 250 (315)

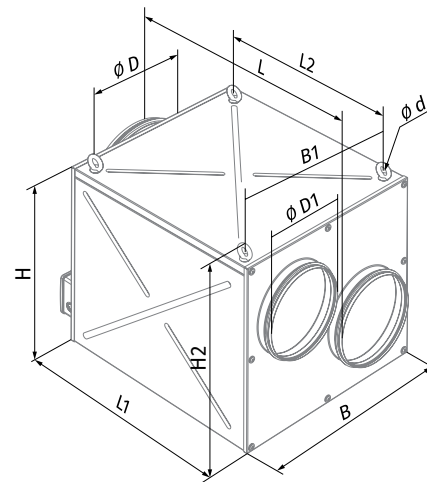

Iso-ZS 315/2x250

SOUND-INSULATED INLINE FANS

Technical data

Parameters	Iso-ZS 250 4E	Iso-ZS 250 4E max	Iso-ZS 250 6E	Iso-ZS 250 6E max
Voltage [V]	1 ~ 230	1 ~ 230	1 ~ 230	1 ~ 230
Frequency [Hz]	50	50	50	50
Power [W]	243	617	120	311
Current [A]	1.06	2.69	0.55	1.36
Maximum air flow [m ³ /h (l/s)]	1520 (422)	2470 (686)	1210 (336)	1680 (467)
RPM [min ⁻¹]	1320	1465	860	940
Sound pressure at 3 m [dBA]	44	46	40	41
Transported air temperature [°C]	-20...+50	-20...+50	-20...+50	-20...+50
SEC class	-	-	C	-
IP rating	IPX4	IPX4	IPX4	IPX4
Motor IP rating	IP42	IP42	IP42	IP42
ErP	2018	-	2018	-

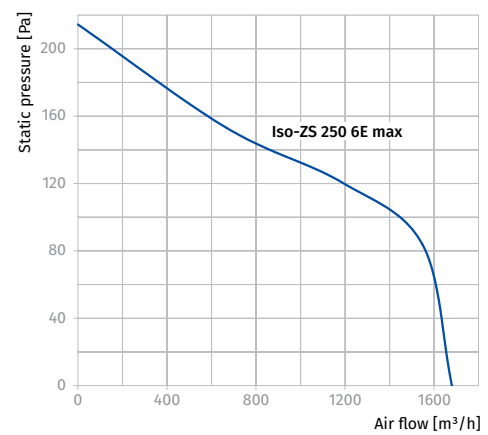
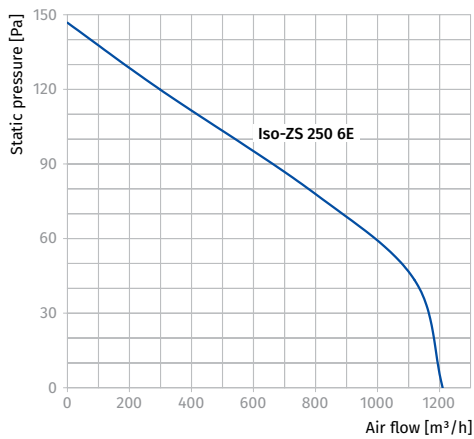
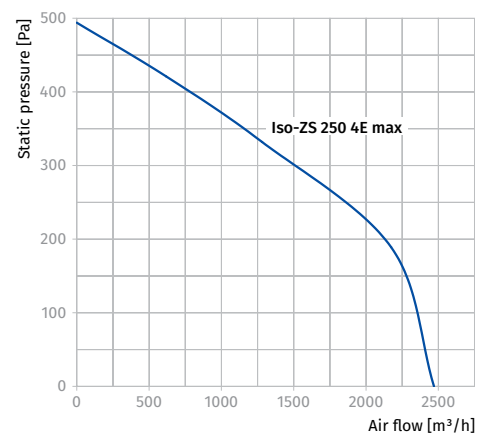
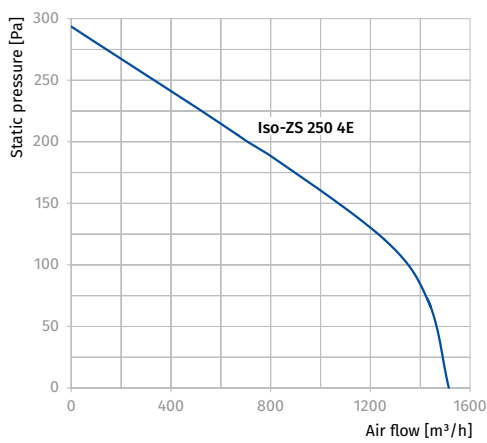

Parameters	Iso-ZS 315 4E	Iso-ZS 315 4E max	Iso-ZS 315/2x250 4E	Iso-ZS 315/2x250 4E max
Voltage [V]	1 ~ 230	1 ~ 230	1 ~ 230	1 ~ 230
Frequency [Hz]	50	50	50	50
Power [W]	723	931	764	1066
Current [A]	3.15	4.18	3.36	4.78
Maximum air flow [m³/h (l/s)]	3200 (889)	3520 (978)	3420 (950)	3930 (1092)
RPM [min ⁻¹]	1350	1430	1390	1455
Sound pressure at 3 m [dBA]	45	47	45	47
Transported air temperature [°C]	-20...+50	-20...+50	-20...+50	-20...+50
SEC class	-	-	-	-
IP rating	IPX4	IPX4	IPX4	IPX4
Motor IP rating	IP42	IP42	IP42	IP42
ErP	-	-	-	-

Parameters	Iso-ZS 315 6E	Iso-ZS 315 6E max	Iso-ZS 315/2x250 6E	Iso-ZS 315/2x250 6E max
Voltage [V]	1 ~ 230	1 ~ 230	1 ~ 230	1 ~ 230
Frequency [Hz]	50	50	50	50
Power [W]	402	800	427	953
Current [A]	2.04	4.59	2.13	5.06
Maximum air flow [m³/h (l/s)]	2460 (683)	3470 (964)	2610 (725)	3850 (1070)
RPM [min ⁻¹]	920	960	955	970
Sound pressure at 3 m [dBA]	42	43	42	43
Transported air temperature [°C]	-20...+50	-20...+50	-20...+50	-20...+50
SEC class	-	-	-	-
IP rating	IPX4	IPX4	IPX4	IPX4
Motor IP rating	IP42	IP42	IP42	IP42
ErP	-	-	-	-

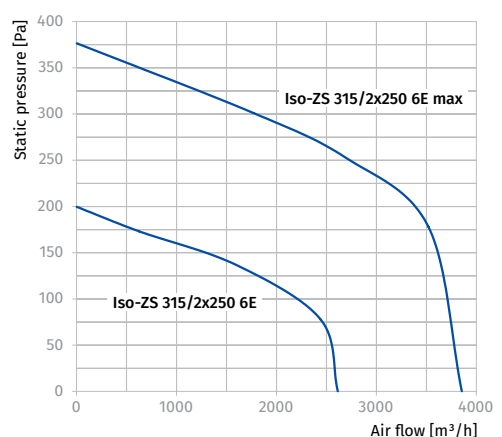
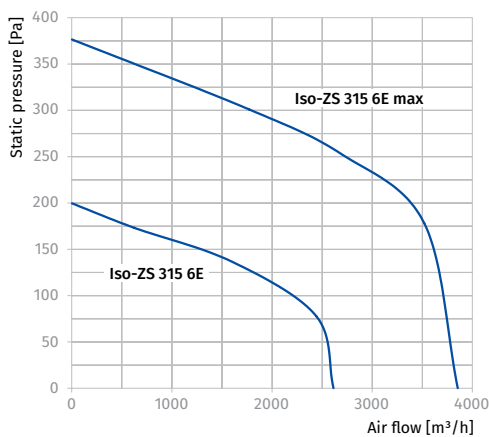
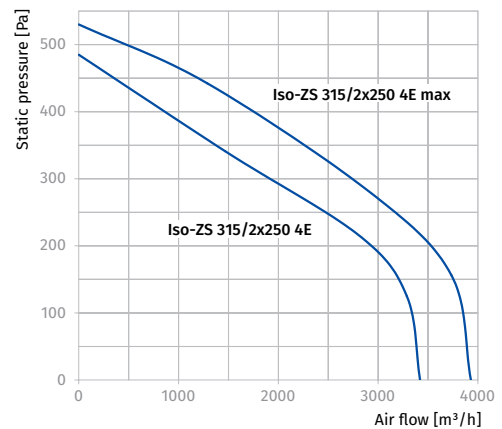
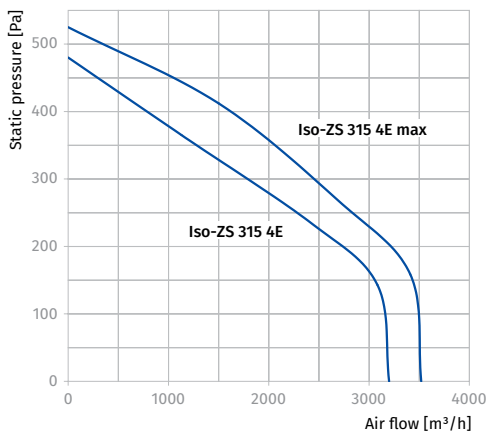

SOUND-INSULATED INLINE FANS

Iso-K

Sound-insulated inline fans

Use

- Hot and highly polluted air extract up to +120 °C in high resistance condition.
- Kitchen placement extract systems (combined with grease filters).
- Ventilation for baking halls.
- Welding gas extract.
- The fans is available for round air ducts Ø 150, 160, 200, 250, 315, 355, 400, 450 mm.



Air flow:
up to 8138 m³/h
2261 l/s



Power:
from 180 W



Noise level:
from 41 dBA



Design

- Galvanized steel casing internally filled with 50 mm thermal- and sound-insulating layer made of non-flammable mineral wool.
- The fan casing is installed on a supporting mounting frame with integrated vibration isolators.
- The swivel motor-impeller block is attached to the swivel door which facilitates the fan servicing.

Motor

- Single- or three-speed motor.
- Galvanized steel impeller.
- Equipped with ball bearings for longer service life.
- Dynamically balanced impeller.
- F class motor winding insulation and IP54 ingress protection rating.

Operation and speed control

- Smooth or step-up speed control with an auto transformer or frequency inverter (both available upon separate order).

Mounting

- Compatible with round air ducts. The spigot diameter matches the standard air duct sizes.
- Mounting to the wall with the mounting angle bracket **UM Iso-K**. Available upon separate order.
- External terminal box on the motor for connection to power mains.

Overall dimensions [mm]

Type	Ø D	B	B1	H	H1	L	L1	L2	L3	L4	Weight [kg]
Iso-K 150 4E	150	410	330	540	365	525	500	470	475	205	17
Iso-K 150 4D	150	410	330	540	365	525	500	470	475	205	17
Iso-K 160 4E	160	410	330	540	365	525	500	470	475	205	17
Iso-K 160 4D	160	410	330	540	365	525	500	470	475	205	17
Iso-K 200 4E	200	485	365	600	425	625	600	570	515	235	25
Iso-K 200 4D	200	485	365	600	425	625	600	570	515	235	25
Iso-K 250 4E	250	575	435	665	505	700	675	645	620	285	40
Iso-K 250 4D	250	575	435	665	505	700	675	645	620	285	40
Iso-K 315 4E	315	690	550	708	600	715	700	650	612	327	53
Iso-K 315 4D	315	690	550	708	600	715	700	650	612	327	52
Iso-K 315 2E	315	690	550	708	600	715	700	650	672	327	61
Iso-K 315 2D	315	690	550	708	600	715	700	650	672	327	60
Iso-K 355 4E	355	740	600	764	655	727	700	650	637	352	60
Iso-K 355 4D	355	740	600	764	655	727	700	650	637	352	59
Iso-K 355 2E	355	740	600	764	655	727	700	650	637	352	68
Iso-K 355 2D	355	740	600	764	655	727	700	650	637	352	65
Iso-K 400 4E	400	906	700	900	790	908	900	850	747	402	92
Iso-K 400 4D	400	906	700	900	790	908	900	850	747	402	92
Iso-K 400 6E	400	906	700	900	790	908	900	850	687	402	87
Iso-K 400 6D	400	906	700	900	790	908	900	850	687	402	87
Iso-K 450 4E	450	996	750	980	870	925	900	850	782	437	109
Iso-K 450 4D	450	996	750	980	870	925	900	850	782	437	109
Iso-K 450 6E	450	996	750	980	870	925	900	850	739	437	105
Iso-K 450 6D	450	996	750	980	870	925	900	850	739	437	105

Designation key

Series	Spigot diameter [mm]	Motor	
		Number of poles	Phase
Iso-K	150; 160; 200; 250; 315; 355; 400; 450	2; 4; 6	E: single-phase D: three-phase

Accessories

Backdraft air dampers	Fixing brackets	Sleeves	Flexible connectors
 VRV	 UM Iso-K	 V Iso-K	 EVA

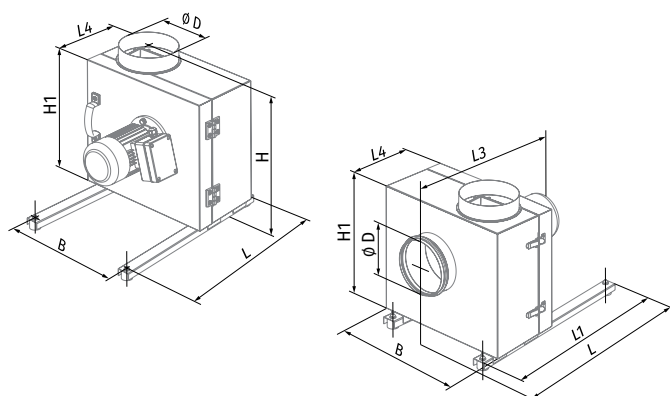

Technical data

Parameters	Iso-K 150 4E / Iso-K 160 4E	Iso-K 150 4D / Iso-K 160 4D	Iso-K 200 4E	Iso-K 200 4D	Iso-K 250 4E	Iso-K 250 4D
Voltage [V]	1 ~ 230	3 ~ 400	1 ~ 230	3 ~ 400	1 ~ 230	3 ~ 400
Frequency [Hz]	50	50	50	50	50	50
Power [W]	180	180	550	750	1500	1500
Current [A]	1.7	0.6	3.0	2.0	11.0	3.4
Maximum air flow [m³/h (l/s)]	700 (194)	730 (203)	1600 (444)	1650 (458)	3400 (945)	3500 (972)
RPM [min⁻¹]	1450	1455	1475	1465	1500	1470
Sound pressure at 3 m [dBA]	41	41	45	45	51	51
Transported air temperature [°C]	-20...+120	-20...+120	-20...+120	-20...+120	-20...+120	-20...+120
IP rating	IP54	IP54	IP54	IP54	IP54	IP54
Motor IP rating	IP54	IP54	IP54	IP54	IP54	IP54

ISO-K 150 4E / ISO-K 160 4E, ISO-K 150 4D / ISO-K 160 4D

Sound power level, A-weighted	Total	Octave frequency bands [Hz]							
		63	125	250	500	1000	2000	4000	8000
L _{WA} to inlet [dBA]	76	68	70	72	62	59	63	57	61
L _{WA} to outlet [dBA]	77	73	77	79	70	66	67	60	53
L _{WA} to environment [dBA]	57	51	56	57	50	49	48	40	33

ISO-K 200 4E, ISO-K 200 4D

Sound power level, A-weighted	Total	Octave frequency bands [Hz]							
		63	125	250	500	1000	2000	4000	8000
L _{WA} to inlet [dBA]	79	71	75	75	66	62	65	58	64
L _{WA} to outlet [dBA]	82	78	78	81	74	68	69	64	56
L _{WA} to environment [dBA]	59	53	60	58	54	50	51	42	36

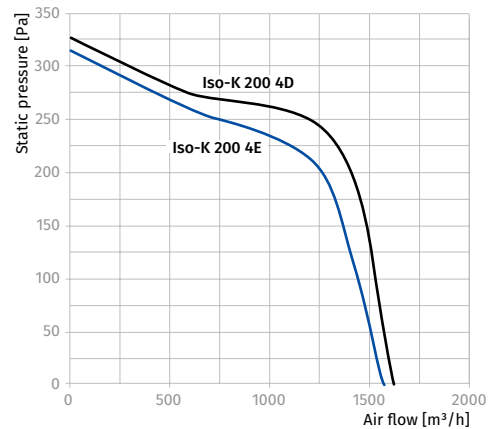
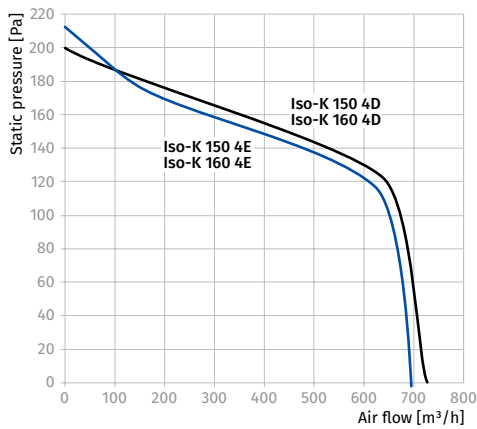

ISO-K 250 4E, ISO-K 250 4D

Sound power level, A-weighted	Total	Octave frequency bands [Hz]							
		63	125	250	500	1000	2000	4000	8000
L _{WA} to inlet [dBA]	82	75	79	80	71	65	68	63	65
L _{WA} to outlet [dBA]	85	79	80	82	79	71	70	65	61
L _{WA} to environment [dBA]	63	55	63	61	57	53	53	45	41

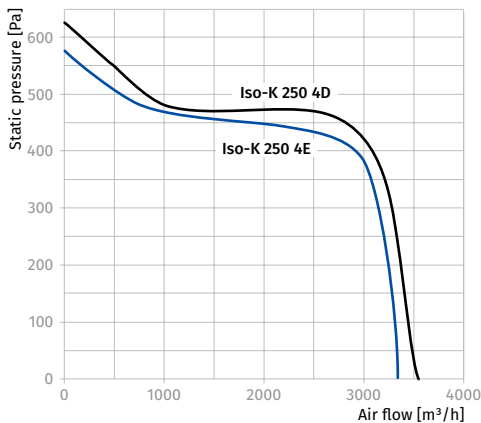

Parameters	Iso-K 315 4E		Iso-K 315 4D		Iso-K 315 2E		Iso-K 315 2D	
Voltage [V]	1 ~ 230		3 ~ 400		1 ~ 230		3 ~ 400	
Frequency [Hz]	50	60	50	60	50	60	50	60
Power [W]	304	383	184	206	1531	2816	1225	2011
Current [A]	1.84	1.72	0.70	0.70	7.35	11.92	2.80	3.40
Maximum air flow [m³/h (l/s)]	1970 (547)	2310 (642)	2040 (567)	2355 (654)	4695 (1304)	5345 (1485)	4710 (1308)	5290 (1470)
RPM [min ⁻¹]	1475	1750	1488	1776	3125	3384	3025	3328
Sound pressure at 3 m [dBA]	46	47	46	48	53	55	52	54
Max. transported air temperature [°C]	-20...+120		-20...+120		-20...+120		-20...+120	
IP rating	IP54		IP54		IP54		IP54	
Motor IP rating	IP54		IP54		IP54		IP54	

ISO-K 315 4E

Sound power level, A-weighted	Total	Octave frequency bands [Hz]								LpA 3 m	LpA 1 m
		63	125	250	500	1000	2000	4000	8000		
LWA to inlet [dBA]	85	66	69	83	78	79	78	73	64	65	75
LWA to outlet [dBA]	87	66	71	84	79	81	79	74	66	67	77
LWA to environment [dBA]	67	45	49	63	58	59	58	53	44	46	56

ISO-K 315 4D

Sound power level, A-weighted	Total	Octave frequency bands [Hz]								LpA 3 m	LpA 1 m
		63	125	250	500	1000	2000	4000	8000		
LWA to inlet [dBA]	85	64	83	79	75	71	69	64	59	65	75
LWA to outlet [dBA]	87	77	85	80	77	72	70	66	61	67	77
LWA to environment [dBA]	67	51	65	60	56	51	49	44	39	46	56

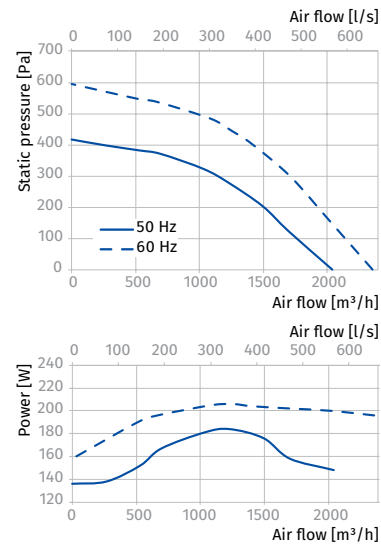
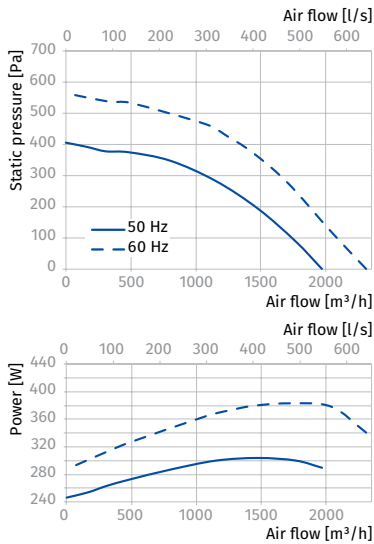

ISO-K 315 2E

Sound power level, A-weighted	Total	Octave frequency bands [Hz]								LpA 3 m	LpA 1 m
		63	125	250	500	1000	2000	4000	8000		
LWA to inlet [dBA]	92	59	65	82	90	84	83	81	74	72	82
LWA to outlet [dBA]	94	61	67	84	92	86	85	83	76	74	84
LWA to environment [dBA]	74	40	46	63	71	65	64	62	55	53	63

ISO-K 315 2D

Sound power level, A-weighted	Total	Octave frequency bands [Hz]								LpA 3 m	LpA 1 m
		63	125	250	500	1000	2000	4000	8000		
LWA to inlet [dBA]	90	58	64	80	89	82	81	79	72	70	80
LWA to outlet [dBA]	92	60	66	82	91	84	83	81	74	72	82
LWA to environment [dBA]	72	39	45	62	70	64	63	61	54	52	62

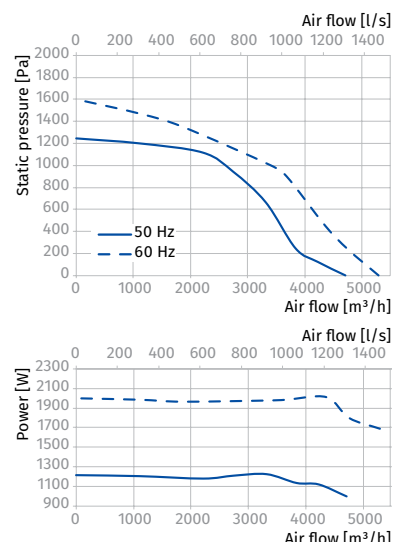
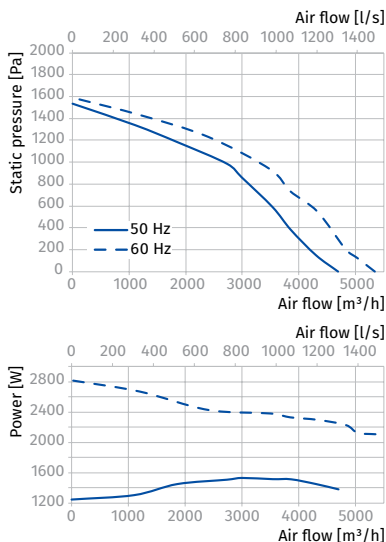

SOUND-INSULATED INLINE FANS

Parameters	Iso-K 355 4E		Iso-K 355 4D		Iso-K 355 2E	Iso-K 355 2D
Voltage [V]	1 ~ 230		3 ~ 400		1 ~ 230	3 ~ 400
Frequency [Hz]	50	60	50	60	50	50
Power [W]	393	525	405	580	2621	3145
Current [A]	2.11	2.34	0.87	1.25	12.66	6.12
Maximum air flow [m³/h (l/s)]	3545 (985)	3860 (1072)	3155 (876)	3270 (908)	6570 (1825)	6185 (1718)
RPM [min ⁻¹]	1517	1705	1379	1578	2890	2652
Sound pressure at 3 m [dBA]	50	52	49	50	54	54
Max. transported air temperature [°C]	-20...+120		-20...+120		-20...+120	-20...+120
IP rating	IP54		IP54		IP54	IP54
Motor IP rating	IP54		IP54		IP54	IP54

ISO-K 355 4E

Sound power level, A-weighted	Total	Octave frequency bands [Hz]								LpA 3 m	LpA 1 m
		63	125	250	500	1000	2000	4000	8000		
LWA to inlet [dBA]	89	74	76	86	81	83	81	75	68	69	79
LWA to outlet [dBA]	91	72	78	88	83	84	83	77	69	71	81
LWA to environment [dBA]	71	50	57	67	62	63	62	55	48	50	60

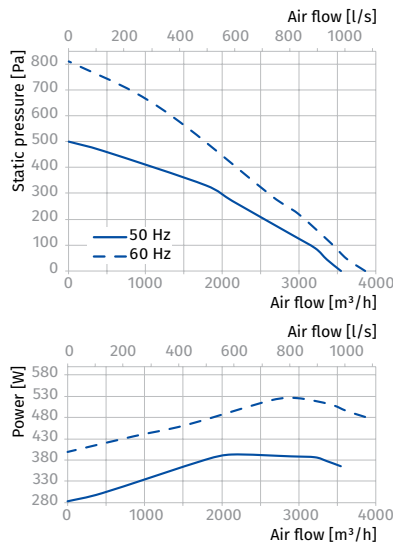

ISO-K 355 4D

Sound power level, A-weighted	Total	Octave frequency bands [Hz]								LpA 3 m	LpA 1 m
		63	125	250	500	1000	2000	4000	8000		
LWA to inlet [dBA]	88	67	87	82	78	74	71	67	62	68	78
LWA to outlet [dBA]	90	80	88	84	80	75	73	68	64	70	80
LWA to environment [dBA]	70	54	68	63	59	54	51	46	41	49	59

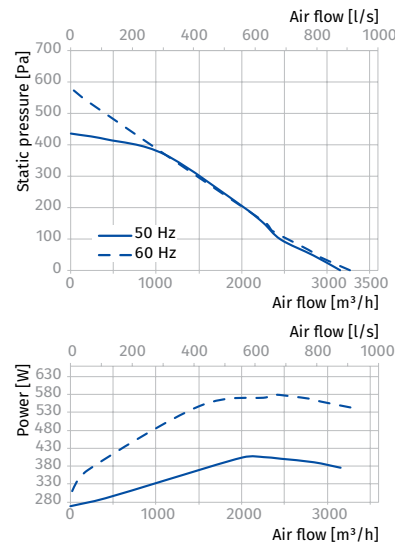

ISO-K 355 2E

Sound power level, A-weighted	Total	Octave frequency bands [Hz]								LpA 3 m	LpA 1 m
		63	125	250	500	1000	2000	4000	8000		
LWA to inlet [dBA]	92	59	66	80	90	85	83	81	73	72	82
LWA to outlet [dBA]	94	65	68	83	92	86	84	82	76	74	84
LWA to environment [dBA]	74	39	46	62	72	66	65	63	56	54	64

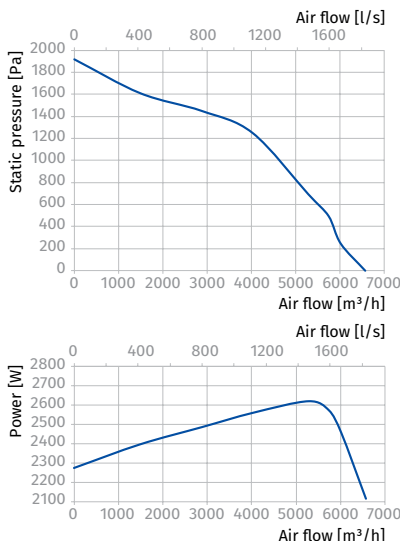

ISO-K 355 2D

Sound power level, A-weighted	Total	Octave frequency bands [Hz]								LpA 3 m	LpA 1 m
		63	125	250	500	1000	2000	4000	8000		
LWA to inlet [dBA]	92	59	65	82	90	84	83	81	74	72	82
LWA to outlet [dBA]	94	61	67	84	92	86	85	83	76	74	84
LWA to environment [dBA]	74	40	47	64	72	66	65	63	55	54	64

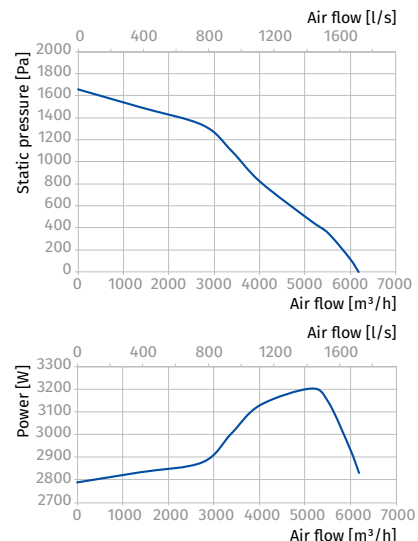

Parameters	Iso-K 400 4E	Iso-K 400 4D	Iso-K 400 6E	Iso-K 400 6D
Voltage [V]	1 ~ 230	3 ~ 400	1 ~ 230	3 ~ 400
Frequency [Hz]	50	50	50	50
Power [W]	1048	785	362	357
Current [A]	5.00	2.25	1.71	0.92
Maximum air flow [m³/h (l/s)]	5392 (1498)	5098 (1416)	2915 (810)	2966 (824)
RPM [min ⁻¹]	1440	1470	930	948
Sound pressure at 3 m [dBA]	54	53	48	47
Max. transported air temperature [°C]	-20...+120	-20...+120	-20...+120	-20...+120
IP rating	IP54	IP54	IP54	IP54
Motor IP rating	IP54	IP54	IP54	IP54

ISO-K 400 4E

Sound power level, A-weighted	Total	Octave frequency bands [Hz]								LpA 3 m	LpA 1 m
		63	125	250	500	1000	2000	4000	8000		
LWA to inlet [dBA]	86	64	79	80	77	78	77	72	67	65	75
LWA to outlet [dBA]	88	69	68	83	82	81	77	72	67	67	77
LWA to environment [dBA]	74	53	67	68	69	66	61	58	53	54	64

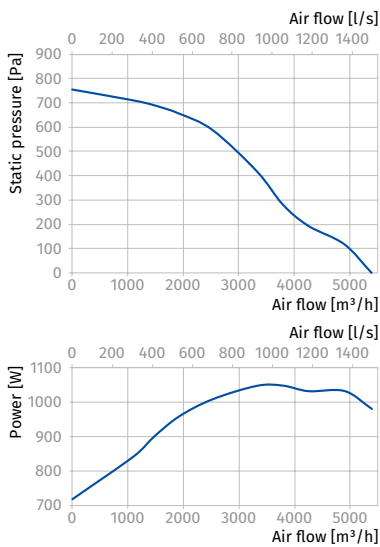

ISO-K 400 4D

Sound power level, A-weighted	Total	Octave frequency bands [Hz]								LpA 3 m	LpA 1 m
		63	125	250	500	1000	2000	4000	8000		
LWA to inlet [dBA]	85	63	79	80	77	78	77	71	66	65	75
LWA to outlet [dBA]	86	67	66	82	81	80	76	70	65	66	76
LWA to environment [dBA]	73	53	66	67	68	65	60	58	53	53	63

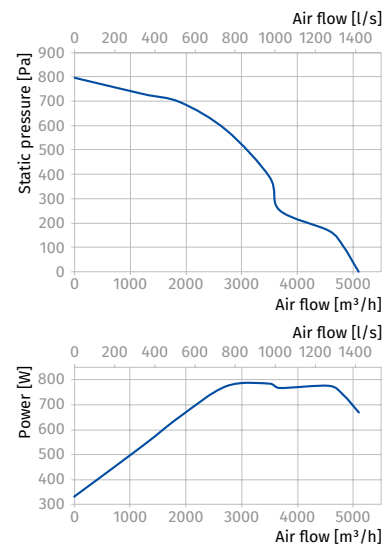

ISO-K 400 6E

Sound power level, A-weighted	Total	Octave frequency bands [Hz]								LpA 3 m	LpA 1 m
		63	125	250	500	1000	2000	4000	8000		
LWA to inlet [dBA]	92	59	65	82	90	84	83	81	74	72	82
LWA to outlet [dBA]	94	61	67	84	92	86	85	83	76	74	84
LWA to environment [dBA]	74	40	46	63	71	65	64	62	55	53	63

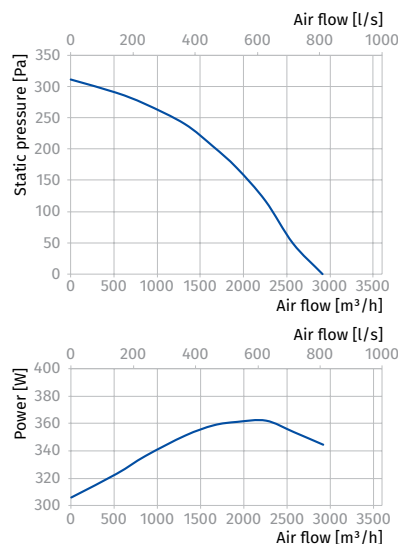

ISO-K 400 6D

Sound power level, A-weighted	Total	Octave frequency bands [Hz]								LpA 3 m	LpA 1 m
		63	125	250	500	1000	2000	4000	8000		
LWA to inlet [dBA]	77	47	58	71	72	69	70	69	65	57	67
LWA to outlet [dBA]	80	59	62	72	74	74	72	68	63	59	69
LWA to environment [dBA]	68	48	49	60	62	62	60	55	52	47	57

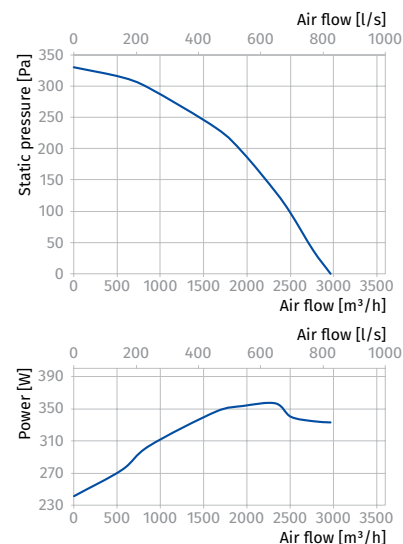

SOUND-INSULATED IN-LINE FANS

Parameters	Iso-K 450 4E	Iso-K 450 4D	Iso-K 450 6E	Iso-K 450 6D
Voltage [V]	1 ~ 230	3 ~ 400	1 ~ 230	3 ~ 400
Frequency [Hz]	50	50	50	50
Power [W]	1570	1350	594	454
Current [A]	7.25	2.81	2.85	1.33
Maximum air flow [m³/h (l/s)]	8138 (2261)	7840 (2178)	5299 (1472)	4991 (1386)
RPM [min ⁻¹]	1470	1450	970	920
Sound pressure at 3 m [dBA]	57	56	50	49
Max. transported air temperature [°C]	-20...+120	-20...+120	-20...+120	-20...+120
IP rating	IP54	IP54	IP54	IP54
Motor IP rating	IP54	IP54	IP54	IP54

ISO-K 450 4E

Sound power level, A-weighted	Total	Octave frequency bands [Hz]								LpA 3 m	LpA 1 m
		63	125	250	500	1000	2000	4000	8000		
LWA to inlet [dBA]	90	67	83	84	81	82	81	75	70	69	79
LWA to outlet [dBA]	92	72	71	87	86	85	81	75	70	71	81
LWA to environment [dBA]	77	56	70	71	72	69	64	61	56	57	67

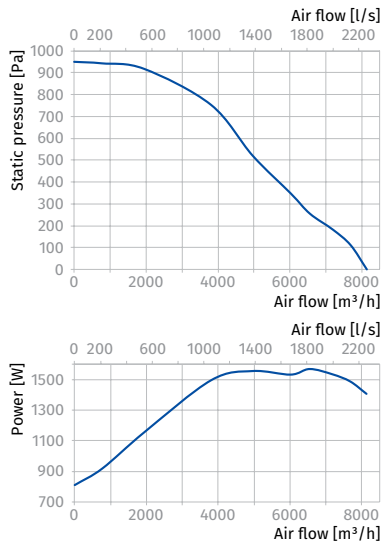

ISO-K 450 4D

Sound power level, A-weighted	Total	Octave frequency bands [Hz]								LpA 3 m	LpA 1 m
		63	125	250	500	1000	2000	4000	8000		
LWA to inlet [dBA]	89	66	83	84	81	82	81	74	69	69	79
LWA to outlet [dBA]	91	71	70	87	86	85	81	74	69	71	81
LWA to environment [dBA]	77	55	70	71	72	69	63	60	55	56	66

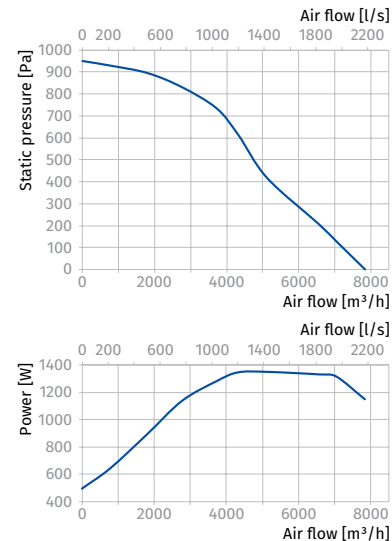

ISO-K 450 6E

Sound power level, A-weighted	Total	Octave frequency bands [Hz]								LpA 3 m	LpA 1 m
		63	125	250	500	1000	2000	4000	8000		
LWA to inlet [dBA]	81	49	61	74	76	73	74	73	68	61	71
LWA to outlet [dBA]	84	62	65	76	78	78	76	72	67	63	73
LWA to environment [dBA]	71	50	52	63	65	66	63	58	55	50	60

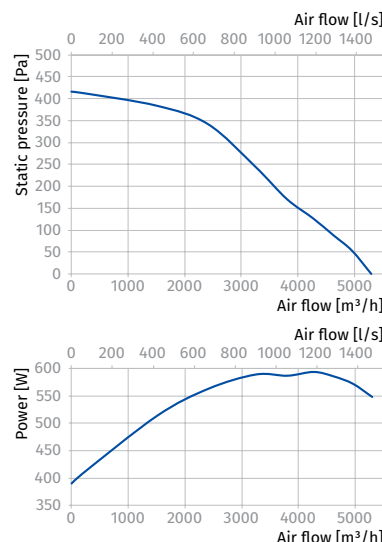

ISO-K 450 6D

Sound power level, A-weighted	Total	Octave frequency bands [Hz]								LpA 3 m	LpA 1 m
		63	125	250	500	1000	2000	4000	8000		
LWA to inlet [dBA]	80	48	60	73	75	71	72	71	67	59	69
LWA to outlet [dBA]	82	61	64	75	76	76	75	70	65	62	72
LWA to environment [dBA]	70	49	51	62	64	65	62	57	54	49	59

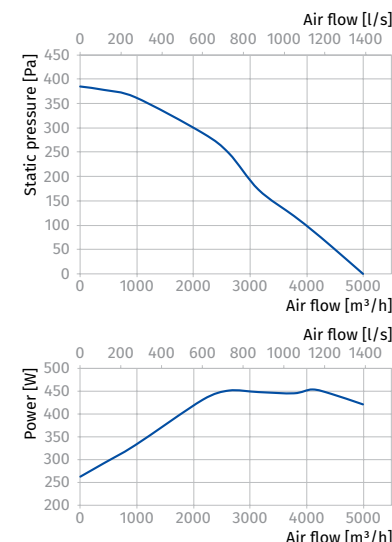

Helix

Centrifugal inline fans

Use

- Supply and extract ventilation systems installed in various premises.
- Suitable for use as ventilation or air conditioning system components.
- Compatible with round and rectangular air ducts.



Air flow:
up to 2000 m³/h
556 l/s



Power:
from 125 W



Noise level:
from 62 dBA



Design

- Compact scroll casing is made of steel and is covered with a special polymer coating.
- The fan is equipped with a round intake flange and exhaust rectangular flange for connection to respective air ducts.
- External terminal block for power supply.
- The fans are equipped with fixing brackets to facilitate fastening at any level surface.

Motor

- Two- or four-pole asynchronous motor with external rotor and centrifugal impeller with forward curved blades.
- Equipped with ball bearings for longer service life.
- Integrated thermal protection with automatic restart.
- Dynamically balanced impeller.

Speed control

- Smooth speed control with an external thyristor controller or step speed control with an external auto transformer (both available upon separate order).

Mounting

- The fan is designed for installation as a single unit or as a component unit of ventilation chambers or air conditioning units.
- The fan has a connection possibility for two air ducts, a rectangular discharge air duct through the flange on the casing as well as a round intake air duct through the connecting flange **FRZ-H**. Available upon separate order.

- In case of rectangular discharge air duct connection a discharge vent must be covered with the **SG-H** grille to protect the fan from foreign object ingress. Available upon separate order.

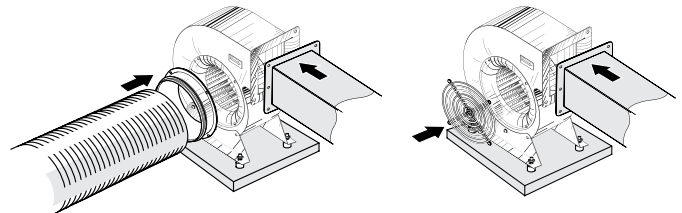

- The vibration isolators, either of rubber type **SI-G** are recommended for noise and vibration attenuation. Vibration isolators reduce dynamic loads on the fan, enhance reliability and durability of the ventilation equipment. The vibration isolators are attached through holes in the mounting pad. Available upon separate order.









SI-G

- Power is supplied to the fan through an external terminal box with sealed electric lead-in.

Designation key

Series	Impeller diameter and width [mm]	Motor Number of poles	Phase
Helix	140x60; 160x62; 160x90; 180x92; 200x80; 200x102; 225x102; 250x140	2; 4	E: single-phase

Accessories

Silencers	Filter boxes	Electric heaters	Water heaters	Backdraft air dampers	Air dampers	Speed controllers
 SD	 KFBK / KFBT	 EKH	 WKH	 VRV	 VKA	 CDT E1.8

Overall dimensions [mm]

Type	∅ D	B	H	H1	H2	L	L1	L2	P	M	Weight [kg]
Helix 140x60 2E	140	243	287	125	93	86	110	78	-	-	3.7
Helix 160x62 2E	160	277	324	136	106	106	130	98	-	-	4.8
Helix 160x90 2E	160	277	324	136	106	136	158	127	-	-	5.1
Helix 180x92 4E	180	311	360	150	120	148	170	140	-	-	7.1
Helix 200x80 4E	200	335	398	165	134	121	140	113	-	-	6.8
Helix 200x102 4E	200	335	398	165	134	157	175	148	-	-	7.3
Helix 225x102 4E	225	365	441	210	171	145	170	137	178	250	11.2
Helix 250x102 4E	250	410	485	230	191	165	190	157	198	270	16.3
Helix 250x140 4E	250	410	485	230	191	205	230	197	238	270	15.5

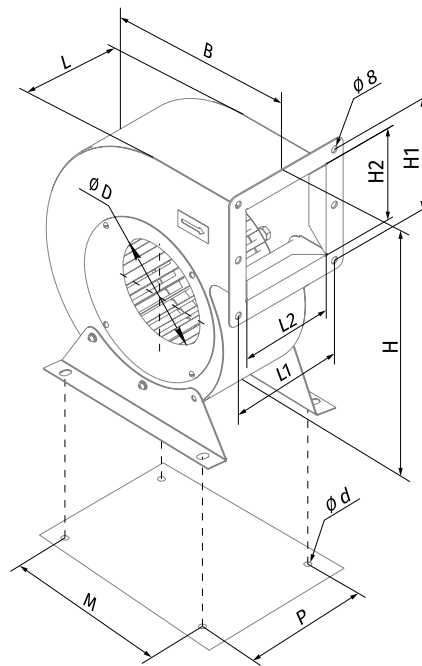

Selection table for accessories

Type	Rubber anti-vibration mounts	Flange	Grille
Helix 140x60 2E	SI-G 8	FRZ-H 140	SG-H 140
Helix 160x62 2E	SI-G 8	FRZ-H 160	SG-H 160
Helix 160x90 2E	SI-G 8	FRZ-H 160	SG-H 160
Helix 180x92 4E	SI-G 8	FRZ-H 180	SG-H 180
Helix 200x80 4E	SI-G 8	FRZ-H 200	SG-H 200
Helix 200x102 4E	SI-G 8	FRZ-H 200	SG-H 200
Helix 225x102 4E	SI-G 16	FRZ-H 225	SG-H 225
Helix 250x102 4E	SI-G 16	FRZ-H 250	SG-H 250
Helix 250x140 4E	SI-G 16	FRZ-H 250	SG-H 250

Technical data

Parameters	Helix 140x60 2E	Helix 160x62 2E	Helix 180x92 4E	Helix 200x80 4E	Helix 200x102 4E	Helix 225x102 4E	Helix 250x102 4E	Helix 250x140 4E
Voltage [V]	1 ~ 230	1 ~ 230	1 ~ 230	1 ~ 230	1 ~ 230	1 ~ 230	1 ~ 230	1 ~ 230
Frequency [Hz]	50	50	50	50	50	50	50	50
Power [W]	148	264	160	125	280	395	810	570
Current [A]	0.64	1.17	0.7	0.55	1.25	1.98	3.65	2.48
Maximum air flow [m³/h (l/s)]	515 (143)	560 (156)	800 (222)	730 (203)	1350 (375)	1480 (411)	2000 (556)	2000 (556)
RPM [min ⁻¹]	2820	2630	1465	1430	1475	1330	1330	1310
Sound pressure at 3 m [dBA]	68	70	62	63	65	69	63	60
Transported air temperature [°C]	-25...+45	-25...+50	-25...+45	-25...+45	-25...+40	-40...+70	-40...+70	-40...+70
SEC class	C	C	B	B	-	-	-	-
IP rating	IPX4	IPX4	IPX4	IPX4	IPX4	IPX4	IPX4	IPX4
Motor IP rating	IP44	IP44	IP44	IP44	IP44	IP44	IP44	IP44
ErP	2018	2018	2018	2018	-	-	-	-

HELIX 140x60 2E, HELIX 180x92 4E

Sound power level, A-weighted	Total	Octave frequency bands [Hz]							
		63	125	250	500	1000	2000	4000	8000
Helix 140x60 2E									
LWA to inlet [dBA]	60	44	51	50	37	33	31	27	17
LWA to outlet [dBA]	58	45	53	44	43	38	31	26	19
LWA to environment [dBA]	50	41	48	44	35	31	24	20	15
Helix 180x92 4E									
LWA to inlet [dBA]	56	43	54	52	38	34	30	29	17
LWA to outlet [dBA]	56	46	55	45	42	35	30	27	21
LWA to environment [dBA]	52	39	47	46	35	28	24	18	17

HELIX 160x62 2E

Sound power level, A-weighted	Total	Octave frequency bands [Hz]							
		63	125	250	500	1000	2000	4000	8000
LWA to inlet [dBA]	57	42	54	54	38	34	31	28	21
LWA to outlet [dBA]	57	46	57	45	42	38	31	26	20
LWA to environment [dBA]	49	37	48	42	33	29	25	19	16

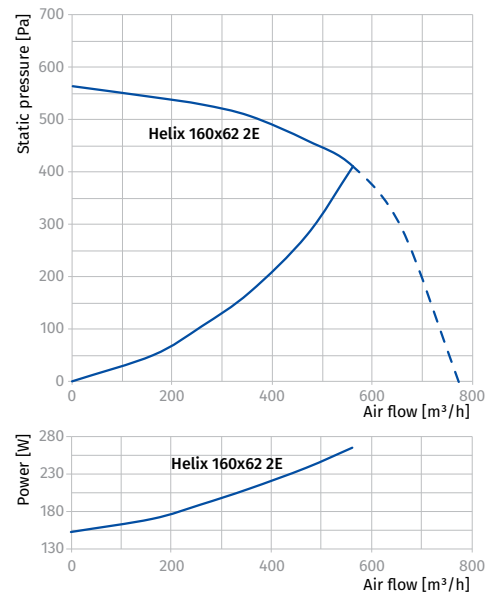
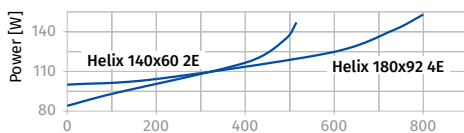
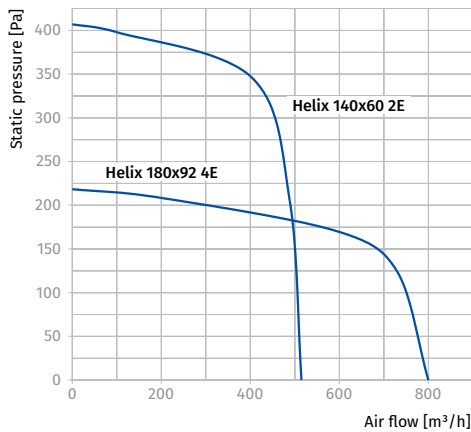

HELIX 200x102 4E, HELIX 200x80 4E

Sound power level, A-weighted	Total	Octave frequency bands [Hz]							
		63	125	250	500	1000	2000	4000	8000
Helix 200x102 4E									
L _{WA} to inlet [dBA]	41	37	38	37	30	26	19	17	14
L _{WA} to outlet [dBA]	42	40	41	36	36	25	16	17	18
L _{WA} to environment [dBA]	37	32	35	29	26	20	16	11	11
Helix 200x80 4E									
L _{WA} to inlet [dBA]	41	38	39	34	31	29	20	18	13
L _{WA} to outlet [dBA]	44	40	40	36	34	25	20	16	17
L _{WA} to environment [dBA]	37	33	37	30	25	21	16	13	13

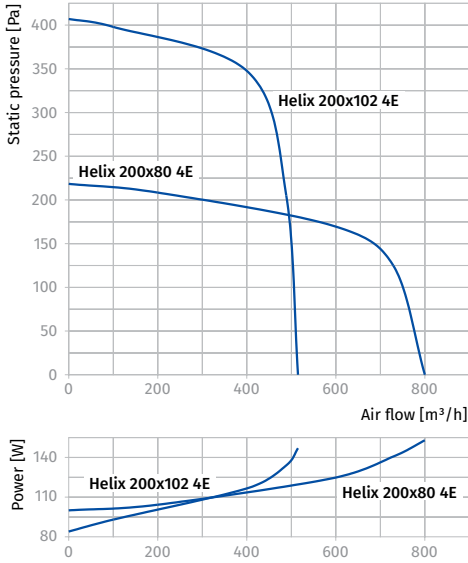

HELIX 225x102 4E

Sound power level, A-weighted	Total	Octave frequency bands [Hz]							
		63	125	250	500	1000	2000	4000	8000
L _{WA} to inlet [dBA]	39	37	38	38	31	28	21	17	15
L _{WA} to outlet [dBA]	44	37	41	38	34	27	16	17	19
L _{WA} to environment [dBA]	37	31	33	31	25	20	17	13	11

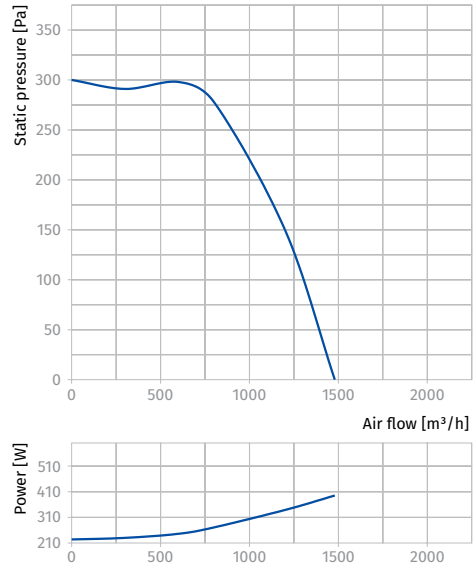

HELIX 250x140 4E, HELIX 250x102 4E

Sound power level, A-weighted	Total	Octave frequency bands [Hz]							
		63	125	250	500	1000	2000	4000	8000
Helix 250x140 4E									
L _{WA} to inlet [dBA]	44	44	42	36	31	22	29	21	19
L _{WA} to outlet [dBA]	46	37	42	38	29	28	29	23	21
L _{WA} to environment [dBA]	40	34	37	31	27	21	24	17	14
Helix 250x102 4E									
L _{WA} to inlet [dBA]	48	45	43	35	34	27	28	25	22
L _{WA} to outlet [dBA]	47	41	43	35	30	29	32	24	23
L _{WA} to environment [dBA]	45	36	39	33	31	25	26	21	18

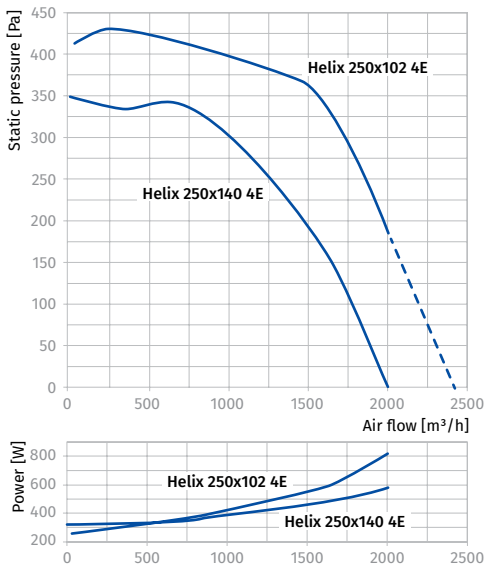

S-Vent

Centrifugal inline fans

Use

- Extract ventilation systems installed in various premises.
- Suitable for use as a component of an assembled air handling or conditioning unit.
- Compatible with Ø 140 up to 500 mm round air ducts or 125x125 up to 800x800 mm rectangular air ducts.



Air flow:
up to 19000 m³/h
5278 l/s



Power:
from 250 W



Noise level:
from 60 dBA



Design

- Scroll casing is made of steel and is covered with a special polymer coating.
- The fan is equipped with a round intake flange and exhaust rectangular flange for connection to respective air ducts.
- The fan casing design provides several impeller rotating positions rightwards (R) or leftwards (L) with 45° pitch angle.
- The casing includes mounting brackets with a mount pad for to facilitate the fan installation to an even surface.

Motor

- Two-, four-, six- or eight-pole three-phase asynchronous motor with centrifugal impeller and forward curved blades.
- Galvanized steel impeller.
- Equipped with ball bearings for longer service life.
- Dynamically balanced impeller.
- IP54 ingress protection rating.

Speed control

- Smooth or step-up speed control with an external auto transformer or frequency inverter (both available upon separate order).

Mounting

- The fan is designed for installation as a single unit or as a component unit of ventilation chambers or air conditioning units.
- The fan has a connection possibility for two air ducts, a rectangular discharge air duct through the flange on the casing as well as a round intake air duct through the connecting flange **FRZ-SV**. Available upon separate order.
- In case of rectangular discharge air duct connection a discharge vent must be covered with the **SG-SV** grille to protect the fan from foreign object ingress. Available upon separate order.
- The vibration isolators, either of rubber type **SI-G** or spring-loaded type **SI-F**, are recommended for noise and vibration attenuation. Vibration isolators reduce dynamic loads on the fan, enhance reliability and durability of the ventilation equipment. The vibration isolators are attached through holes in the mounting pad. Available upon separate order.

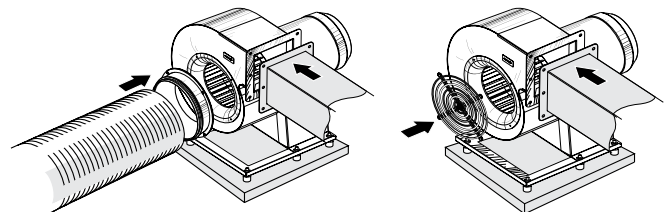

SI-G



SI-F

Designation key

Series	Impeller diameter and width [mm]	Motor power [kW]	Number of poles	Phase	Casing modification	Spiral casing pitch angle
S-Vent	140x74; 160x74; 180x74; 200x93; 225x103; 240x114; 250x127; 280x127; 315x143; 355x143; 400x183; 450x203; 500x229	- 0.25; 0.37; 0.55; 0.75; 1.1; 1.5; 2.2; 3; 4; 5.5; 7.5; 11	- 2; 4; 6; 8	E: single-phase D: three-phase	R: Right L: Left	0; 45; 90; 135; 180; 225; 270; 315

Accessories

Silencers	Filter boxes	Electric heaters	Water heaters	Backdraft air dampers	Air dampers	Flexible antivibration connectors
SD / SDF	KFBK / KFBT	EKH	WKH	VRV	VK / VKA	EVAF

Overall dimensions [mm]

Type	∅ D	∅ d	∅ D1	B	H	H1	H2	L	L1	L2	P	M	I	G	K	S	Weight [kg]
S-Vent 140x74-0.25-4D	140	8	10	242	323	125	92	309	125	95	124	220	234	18	253	80	9.3
S-Vent 140x74-0.37-2D	140	8	10	242	323	125	92	309	125	95	124	220	234	18	253	80	9.3
S-Vent 160x74-0.55-4D	160	8	10	277	373	134	106	356	134	104	141	220	260	17	252	90	12.7
S-Vent 160x74-0.75-2D	160	8	10	277	373	134	106	356	134	104	141	220	260	17	252	90	13.0
S-Vent 180x74-0.55-4D	180	10	10	311	414	143	120	365	143	114	146	270	270	22	314	90	13.5
S-Vent 180x74-1.1-2D	180	10	10	311	414	143	120	365	143	114	146	270	270	22	314	90	14.5
S-Vent 200x93-0.55-4D	200	10	10	345	436	160	134	380	160	129	158	270	284	24	315	90	15.2
S-Vent 200x93-1.1-2D	200	10	10	345	436	160	134	380	160	129	158	270	284	24	315	90	16.2
S-Vent 225x103-1.1-4D	225	10	12	388	507	178	151	432	172	141	174	275	316	27	330	100	21.2
S-Vent 225x103-2.2-2D	225	10	12	388	507	178	151	432	172	141	174	275	316	27	330	100	24.2
S-Vent 240x114-2.2-4D	240	10	12	414	568	186	161	461	186	156	195	275	362	27	330	125	30.5
S-Vent 240x114-3.0-2D	240	10	12	414	568	186	161	461	186	156	195	275	362	27	330	125	31.4
S-Vent 250x127-1.5-6D	250	10	12	431	594	202	168	473	202	166	206	300	373	27	355	125	33.0
S-Vent 250x127-2.2-4D	250	10	12	431	594	202	168	473	202	166	206	300	373	27	355	125	32.2
S-Vent 250x127-5.5-2D	250	10	12	431	614	202	168	517	202	166	213	300	397	27	355	140	40.0
S-Vent 280x127-1.5-6D	280	10	12	483	626	225	189	503	231	196	243	300	410	27	355	125	35.1
S-Vent 280x127-2.2-4D	280	10	12	483	626	225	189	503	231	196	243	300	410	27	355	125	34.2
S-Vent 280x127-5.5-2D	280	10	12	483	646	225	189	545	231	196	243	300	427	27	355	140	42.4
S-Vent 315x143-2.2-6D	315	10	15	543	731	250	213	568	255	216	268	350	452	27	405	140	46.8
S-Vent 315x143-4.0-4D	315	10	15	543	731	250	213	568	255	216	268	350	452	27	405	140	49.8
S-Vent 355x143-2.2-6D	355	10	15	611	817	275	241	566	255	214	253	350	442	32	405	140	49.0
S-Vent 355x143-4.0-4D	355	10	15	611	817	275	241	566	255	214	253	350	442	32	405	140	51.0
S-Vent 400x183-1.5-8D	400	10	15	689	870	310	272	619	310	268	313	400	497	27	455	140	57.1
S-Vent 400x183-2.2-6D	400	10	15	689	870	310	272	619	310	268	313	400	497	27	455	140	54.1
S-Vent 400x183-5.5-4D	400	10	15	689	882	310	272	662	330	289	341	400	525	27	455	140	69.5
S-Vent 450x203-3.0-8D	450	10	15	774	985	345	306	690	352	315	351	450	550	42	530	140	77.8
S-Vent 450x203-4.0-6D	450	10	15	774	985	345	306	690	352	315	351	450	550	42	530	140	76.5
S-Vent 450x203-11.0-4D	450	10	15	774	1005	345	306	722	352	315	371	450	608	42	530	178	105.0
S-Vent 500x229-5.5-8D	500	11	15	860	1115	390	341	761	401	353	408	500	645	42	580	178	85.0
S-Vent 500x229-7.5-6D	500	11	15	860	1115	390	341	761	401	353	408	500	645	42	580	178	86.0
S-Vent 500x229-11.0-4D	500	11	15	860	1115	390	341	761	401	353	408	500	645	42	580	178	107.0

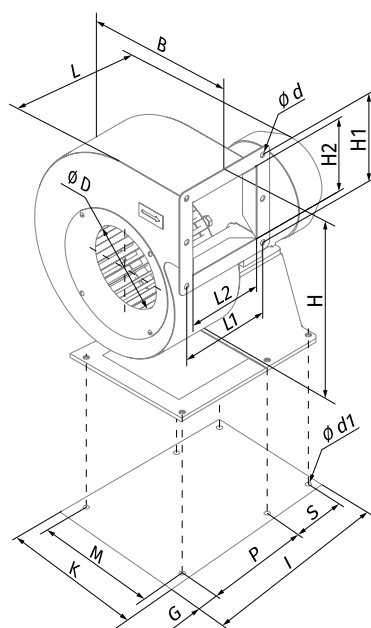

Technical data

Parameters	S-Vent 140x74-0.25-4D	S-Vent 140x74-0.37-2D	S-Vent 160x74-0.55-4D	S-Vent 160x74-0.75-2D	S-Vent 180x74-0.55-4D	S-Vent 180x74-1.1-2D	S-Vent 200x93-0.55-4D	S-Vent 200x93-1.1-2D
Voltage [V]	3 ~ 400	3 ~ 400	3 ~ 400	3 ~ 400	3 ~ 400	3 ~ 400	3 ~ 400	3 ~ 400
Frequency [Hz]	50	50	50	50	50	50	50	50
Power [kW]	0.25	0.37	0.55	0.75	0.55	1.1	0.55	1.1
Current [A]	0.8	0.9	1.6	1.8	1.6	2.6	1.6	2.6
Maximum air flow [m³/h (l/s)]	450 (125)	710 (197)	750 (208)	1540 (428)	1030 (286)	1950 (542)	1615 (449)	1900 (528)
RPM [min ⁻¹]	1350	2730	1360	2820	1360	2800	1360	2800
Sound pressure at 3 m [dBA]	60	65	62	68	64	70	67	73
Max. transported air temperature [°C]	+60	+60	+60	+60	+60	+60	+60	+60
SEC class	D	D	D	-	D	-	-	-
IP rating	IP54	IP54	IP54	IP54	IP54	IP54	IP54	IP54
Motor IP rating	IP54	IP54	IP54	IP54	IP54	IP54	IP54	IP54
ErP	2018	2018	2018	2018	2018	-	-	-

S-VENT 140x74-0.37-2D, S-VENT 140x74-0.25-4D

Sound power level, A-weighted	Total	Octave frequency bands [Hz]							
		63	125	250	500	1000	2000	4000	8000
S-Vent 140x74-0.37-2D									
LWA to environment [dBA]	68	47	59	69	72	74	75	72	71
S-Vent 140x74-0.25-4D									
LWA to environment [dBA]	61	43	58	64	61	68	68	65	63

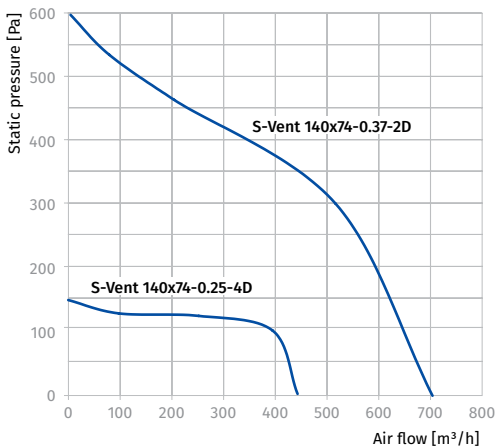
S-VENT 160x74-0.75-2D, S-VENT 160x74-0.55-4D

Sound power level, A-weighted	Total	Octave frequency bands [Hz]							
		63	125	250	500	1000	2000	4000	8000
S-Vent 160x74-0.75-2D									
LWA to environment [dBA]	67	48	60	69	74	74	78	73	72
S-Vent 160x74-0.55-4D									
LWA to environment [dBA]	63	46	59	64	65	69	71	68	65

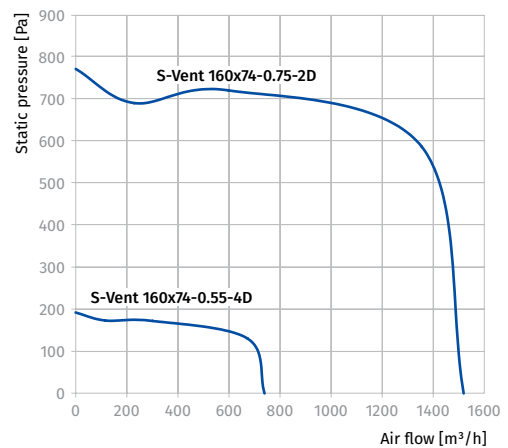
S-VENT 180x74-1.1-2D, S-VENT 180x74-0.55-4D

Sound power level, A-weighted	Total	Octave frequency bands [Hz]							
		63	125	250	500	1000	2000	4000	8000
S-Vent 180x74-1.1-2D									
LWA to environment [dBA]	70	53	62	72	78	77	81	78	77
S-Vent 180x74-0.55-4D									
LWA to environment [dBA]	62	50	63	68	67	73	75	69	67

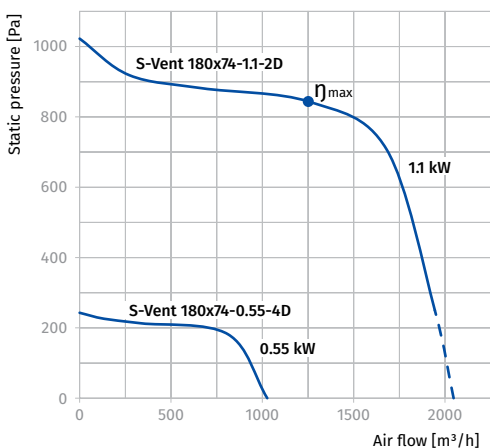
S-VENT 200x93-1.1-2D, S-VENT 200x93-0.55-4D

Sound power level, A-weighted	Total	Octave frequency bands [Hz]							
		63	125	250	500	1000	2000	4000	8000
S-Vent 200x93-1.1-2D									
LWA to environment [dBA]	75	54	65	78	81	81	85	78	78
S-Vent 200x93-0.55-4D									
LWA to environment [dBA]	65	51	64	71	72	75	77	72	70

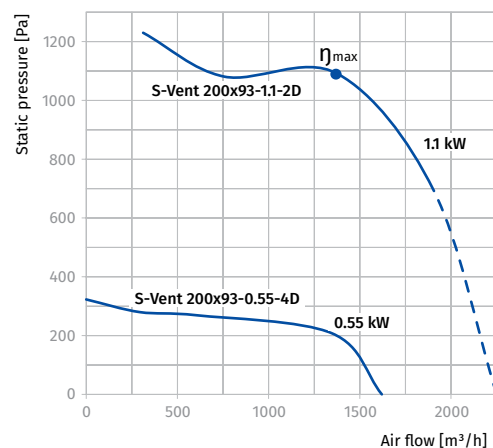

Parameters	S-Vent 225x103-1.1-4D	S-Vent 225x103-2.2-2D	S-Vent 240x114-2.2-4D	S-Vent 240x114-3.0-2D	S-Vent 250x127-1.5-6D	S-Vent 250x127-2.2-4D	S-Vent 250x127-5.5-2D	S-Vent 280x127-1.5-6D
Voltage [V]	3 ~ 400	3 ~ 400	3 ~ 400	3 ~ 400	3 ~ 400	3 ~ 400	3 ~ 400	3 ~ 400
Frequency [Hz]	50	50	50	50	50	50	50	50
Power [kW]	1.1	2.2	2.2	3.0	1.5	2.2	5.5	1.5
Current [A]	2.8	4.7	5.1	6.1	4.2	5.1	10.7	4.2
Maximum air flow [m³/h (l/s)]	2125 (590)	3350 (931)	2930 (814)	4350 (1208)	2415 (671)	3720 (1033)	4820 (1339)	3450 (958)
RPM [min⁻¹]	1420	2865	1420	2870	940	1420	2850	940
Sound pressure at 3 m [dBA]	72	75	74	78	68	78	81	69
Max. transported air temperature [°C]	+60	+60	+60	+60	+60	+60	+60	+60
SEC class	-	-	-	-	-	-	-	-
IP rating	IP54	IP54	IP54	IP54	IP54	IP54	IP54	IP54
Motor IP rating	IP54	IP54	IP54	IP54	IP54	IP54	IP54	IP54
ErP	-	2018	-	-	-	-	-	-

S-VENT 225x103-2.2-2D, S-VENT 225x103-1.1-4D

Sound power level, A-weighted	Total	Octave frequency bands [Hz]							
		63	125	250	500	1000	2000	4000	8000
S-Vent 225x103-2.2-2D									
LWA to environment [dBA]	75	58	67	78	83	83	88	81	79
S-Vent 225x103-1.1-4D									
LWA to environment [dBA]	72	55	65	75	76	81	81	77	75

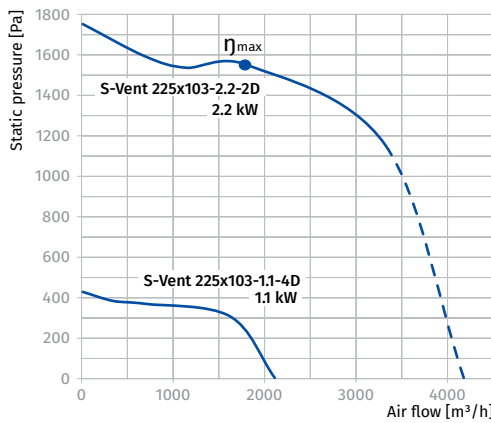

S-VENT 240x114-2.2-4D, S-VENT 240x114-3.0-2D

Sound power level, A-weighted	Total	Octave frequency bands [Hz]							
		63	125	250	500	1000	2000	4000	8000
S-Vent 240x114-2.2-4D									
LWA to environment [dBA]	71	57	69	75	75	81	82	79	76
S-Vent 240x114-3.0-2D									
LWA to environment [dBA]	77	58	69	74	78	73	79	78	78

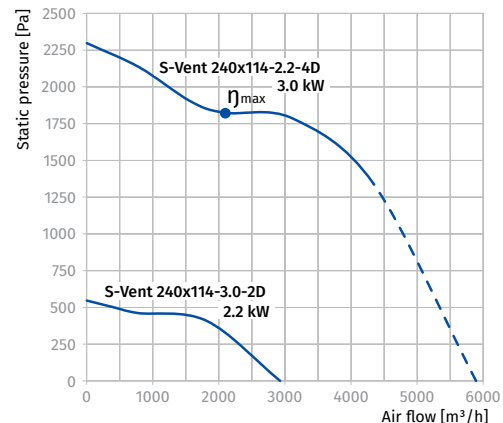

S-VENT 250x127-2.2-4D, S-VENT 250x127-1.5-6D

Sound power level, A-weighted	Total	Octave frequency bands [Hz]							
		63	125	250	500	1000	2000	4000	8000
S-Vent 250x127-2.2-4D									
LWA to environment [dBA]	70	56	71	77	74	81	82	80	73
S-Vent 250x127-1.5-6D									
LWA to environment [dBA]	65	50	62	68	68	73	71	72	65

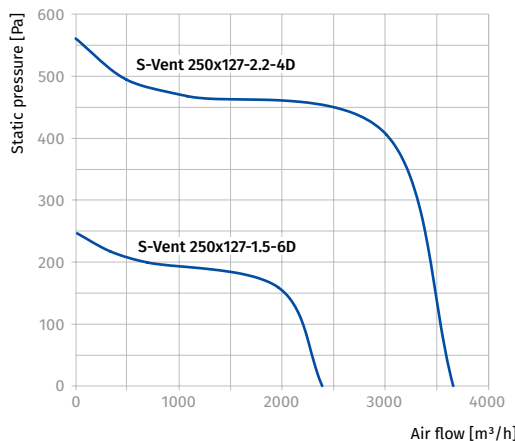

S-VENT 250x127-5.5-2D

Sound power level, A-weighted	Total	Octave frequency bands [Hz]							
		63	125	250	500	1000	2000	4000	8000
LWA to environment [dBA]	78	57	71	79	84	85	89	83	81

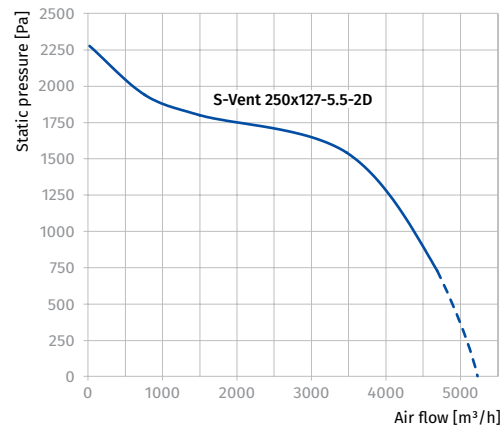

Parameters	S-Vent 280x127-2.2-4D	S-Vent 280x127-5.5-2D	S-Vent 315x143-2.2-6D	S-Vent 315x143-4.0-4D	S-Vent 355x143-2.2-6D	S-Vent 355x143-4.0-4D	S-Vent 400x183-1.5-8D	S-Vent 400x183-2.2-6D
Voltage [V]	3 ~ 400	3 ~ 400	3 ~ 400	3 ~ 400	3 ~ 400	3 ~ 400	3 ~ 400	3 ~ 400
Frequency [Hz]	50	50	50	50	50	50	50	50
Power [kW]	2.2	5.5	2.2	4.0	2.2	4.0	1.5	2.2
Current [A]	5.1	10.7	5.6	8.7	5.6	8.7	4.2	5.8
Maximum air flow [m ³ /h (l/s)]	4395 (1221)	6330 (1758)	4375 (1215)	6530 (1814)	5090 (1414)	8150 (2264)	6545 (1818)	8100 (2250)
RPM [min ⁻¹]	1420	2865	940	1410	940	1410	700	940
Sound pressure at 3 m [dBA]	75	81	70	79	71	79	62	73
Max. transported air temperature [°C]	60	60	60	60	60	60	60	60
SEC class	-	-	-	-	-	-	-	-
IP rating	IP54	IP54	IP54	IP54	IP54	IP54	IP54	IP54
Motor IP rating	IP54	IP54	IP54	IP54	IP54	IP54	IP54	IP54
ErP	-	-	-	-	-	-	-	-

S-VENT 280x127-2.2-4D, S-VENT 280x127-1.5-6D

Sound power level, A-weighted	Total	Octave frequency bands [Hz]							
		63	125	250	500	1000	2000	4000	8000
S-Vent 280x127-2.2-4D									
LWA to environment [dBA]	73	61	74	76	81	82	83	81	77
S-Vent 280x127-1.5-6D									
LWA to environment [dBA]	67	50	63	69	67	73	71	69	66

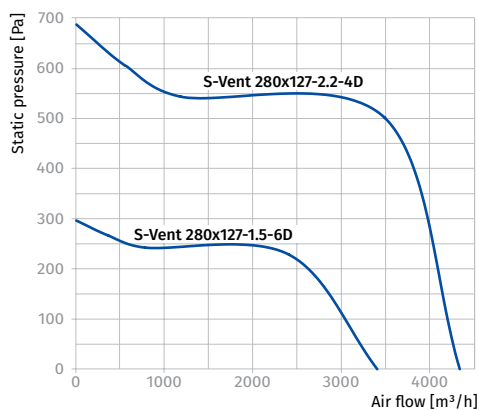
S-VENT 280x127-5.5-2D

Sound power level, A-weighted	Total	Octave frequency bands [Hz]							
		63	125	250	500	1000	2000	4000	8000
LWA to environment [dBA]	80	63	72	81	88	86	91	87	86

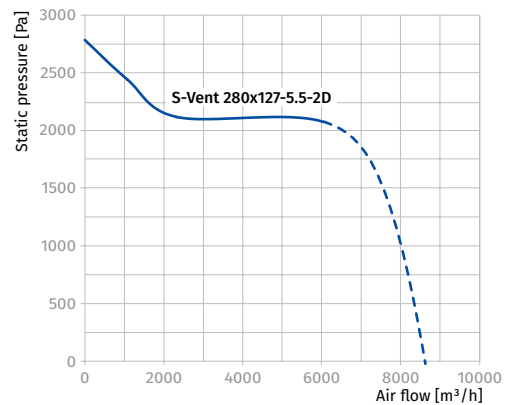
S-VENT 315x143-4.0-4D, S-VENT 315x143-2.2-6D

Sound power level, A-weighted	Total	Octave frequency bands [Hz]							
		63	125	250	500	1000	2000	4000	8000
S-Vent 315x143-4.0-4D									
LWA to environment [dBA]	78	62	73	81	84	88	86	86	83
S-Vent 315x143-2.2-6D									
LWA to environment [dBA]	71	56	67	70	80	78	79	72	68

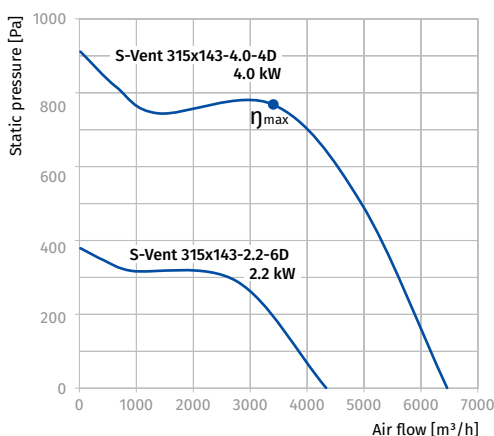
S-VENT 355x143-4.0-4D, S-VENT 355x143-2.2-6D

Sound power level, A-weighted	Total	Octave frequency bands [Hz]							
		63	125	250	500	1000	2000	4000	8000
S-Vent 355x143-4.0-4D									
LWA to environment [dBA]	77	62	75	80	84	87	90	82	82
S-Vent 355x143-2.2-6D									
LWA to environment [dBA]	71	54	68	73	82	82	82	75	72

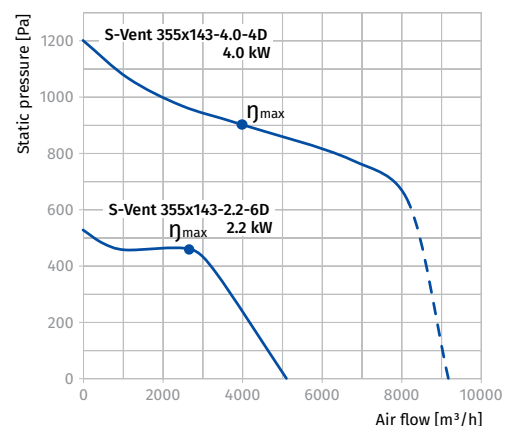

Parameters	S-Vent 400x183-5.5-4D	S-Vent 450x203-3.0-8D	S-Vent 450x203-4.0-6D	S-Vent 450x203-11.0-4D	S-Vent 500x229-5.5-8D	S-Vent 500x229-7.5-6D	S-Vent 500x229-11.0-4D
Voltage [V]	3 ~ 400	3 ~ 400	3 ~ 400	3 ~ 400	3 ~ 400	3 ~ 400	3 ~ 400
Frequency [Hz]	50	50	50	50	50	50	50
Power [kW]	5.5	3.0	4.0	11.0	5.5	7.5	11.0
Current [A]	11.0	7.8	9.1	24.0	14.8	17.0	24.0
Maximum air flow [m³/h (l/s)]	10175 (2827)	10230 (2842)	11150 (3097)	19000 (5278)	11550 (3209)	14960 (4156)	17250 (4792)
RPM [min ⁻¹]	1430	700	950	1450	700	955	1450
Sound pressure at 3 m [dBA]	80	70	76	84	72	78	85
Max. transported air temperature [°C]	60	60	60	60	60	60	60
SEC class	-	-	-	-	-	-	-
IP rating	IP54	IP54	IP54	IP54	IP54	IP54	IP54
Motor IP rating	IP54	IP54	IP54	IP54	IP54	IP54	IP54
ErP	-	-	-	-	-	-	-

S-VENT 400x183-2.2-6D, S-VENT 400x183-1.5-8D

Sound power level, A-weighted	Total	Octave frequency bands [Hz]							
		63	125	250	500	1000	2000	4000	8000
S-Vent 400x183-2.2-6D									
LWA to environment [dBA]	75	57	72	75	81	80	81	78	76
S-Vent 400x183-1.5-8D									
LWA to environment [dBA]	68	53	65	69	74	76	77	73	67

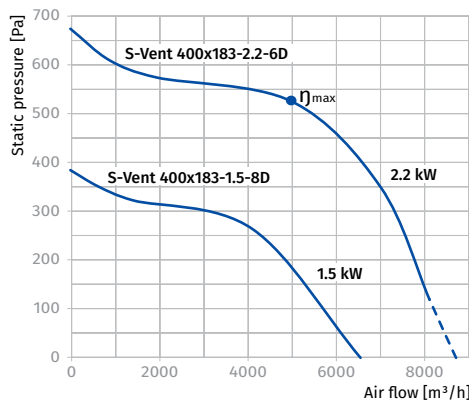

S-VENT 400x183-5.5-4D

Sound power level, A-weighted	Total	Octave frequency bands [Hz]							
		63	125	250	500	1000	2000	4000	8000
LWA to environment [dBA]	75	57	72	75	81	80	81	78	76

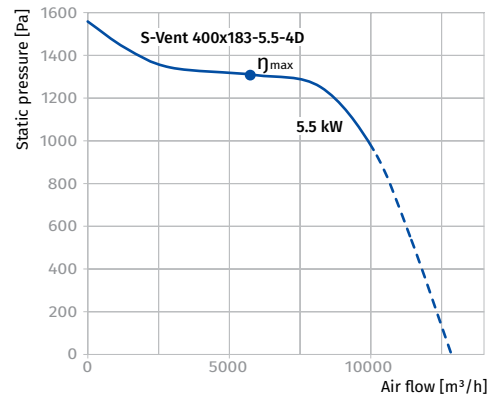

S-VENT 450x203-4.0-6D, S-VENT 450x203-3.0-8D

Sound power level, A-weighted	Total	Octave frequency bands [Hz]							
		63	125	250	500	1000	2000	4000	8000
S-Vent 450x203-4.0-6D									
LWA to environment [dBA]	76	59	74	75	83	83	85	81	77
S-Vent 450x203-3.0-8D									
LWA to environment [dBA]	67	56	63	65	75	75	71	71	69

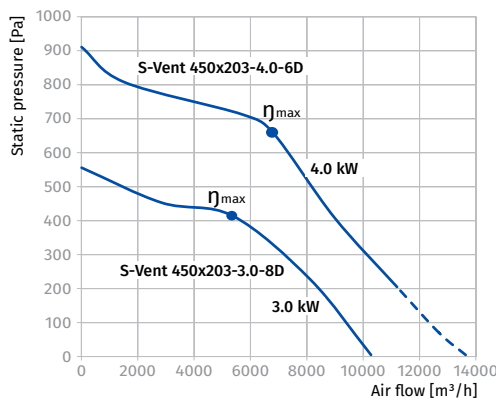

S-VENT 450x203-11.0-4D

Sound power level, A-weighted	Total	Octave frequency bands [Hz]							
		63	125	250	50-0	1000	2000	4000	8000
LWA to environment [dBA]	83	70	84	89	88	94	94	94	91

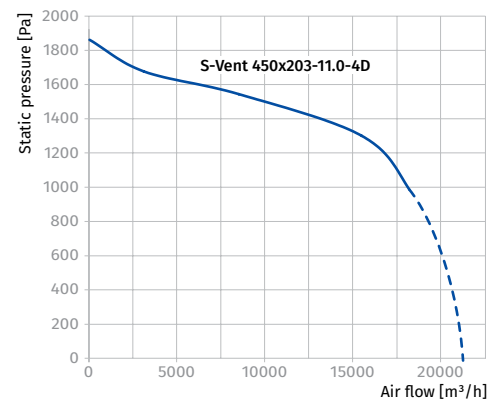

S-VENT 500x229-7.5-6D, S-VENT 500x229-5.5-8D

Sound power level, A-weighted	Total	Octave frequency bands [Hz]							
		63	125	250	500	1000	2000	4000	8000
S-Vent 500x229-7.5-6D									
L _{WA} to environment [dBA]	83	68	79	85	85	93	92	86	85
S-Vent 500x229-5.5-8D									
L _{WA} to environment [dBA]	77	61	74	78	81	86	85	81	80

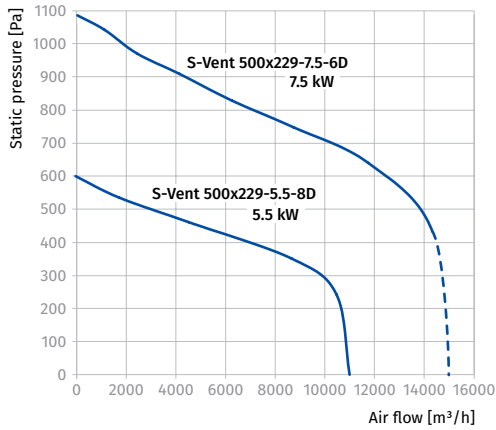

S-VENT 500x229-11.0-4D

Sound power level, A-weighted	Total	Octave frequency bands [Hz]							
		63	125	250	500	1000	2000	4000	8000
L _{WA} to environment [dBA]	85	73	83	90	91	94	97	94	90

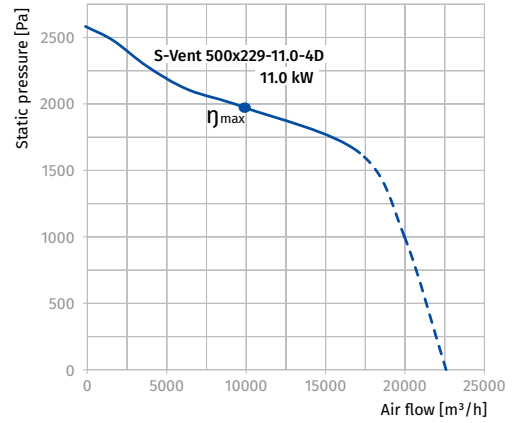

Scroll orientation (view on the intake side)

Right scroll orientation

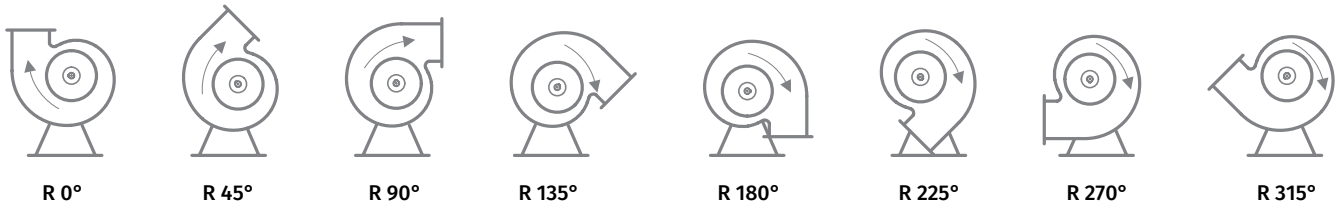

Left scroll orientation

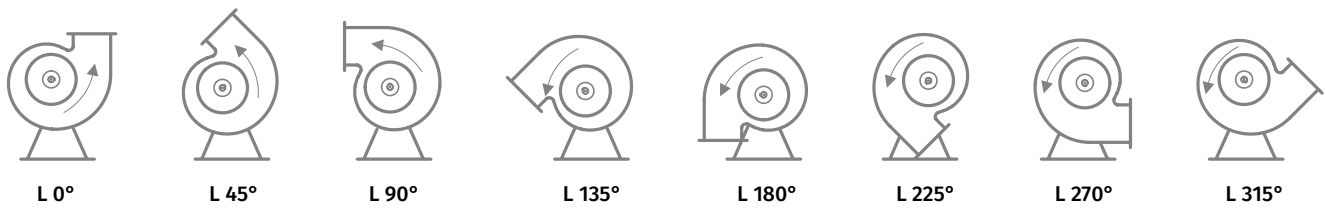

Selection table for accessories

Type	Rubber anti-vibration mounts	Spring-loaded anti-vibration mounts	Flange	Grille
S-Vent 140x74-0.25-4D	SI-G 8	SI-F 8	FRZ-SV 140	SG-SV 140
S-Vent 140x74-0.37-2D	SI-G 8	SI-F 8	FRZ-SV 140	SG-SV 140
S-Vent 160x74-0.55-4D	SI-G 8	SI-F 8	FRZ-SV 160	SG-SV 160
S-Vent 160x74-0.75-2D	SI-G 8	SI-F 8	FRZ-SV 160	SG-SV 160
S-Vent 180x74-0.55-4D	SI-G 8	SI-F 8	FRZ-SV 180	SG-SV 180
S-Vent 180x74-1.1-2D	SI-G 8	SI-F 8	FRZ-SV 180	SG-SV 180
S-Vent 200x93-0.55-4D	SI-G 8	SI-F 8	FRZ-SV 200	SG-SV 200
S-Vent 200x93-1.1-2D	SI-G 8	SI-F 8	FRZ-SV 200	SG-SV 200
S-Vent 225x103-1.1-4D	SI-G 8	SI-F 8	FRZ-SV 225	SG-SV 225
S-Vent 225x103-2.2-2D	SI-G 8	SI-F 8	FRZ-SV 225	SG-SV 225
S-Vent 240x114-2.2-4D	SI-G 16	SI-F 16	FRZ-SV 240	SG-SV 240
S-Vent 240x114-3.0-2D	SI-G 16	SI-F 16	FRZ-SV 240	SG-SV 240
S-Vent 250x127-1.5-6D	SI-G 16	SI-F 16	FRZ-SV 250	SG-SV 250
S-Vent 250x127-2.2-4D	SI-G 16	SI-F 16	FRZ-SV 250	SG-SV 250
S-Vent 250x127-5.5-2D	SI-G 16	SI-F 16	FRZ-SV 250	SG-SV 250
S-Vent 280x127-1.5-6D	SI-G 16	SI-F 16	FRZ-SV 280	SG-SV 280
S-Vent 280x127-2.2-4D	SI-G 16	SI-F 16	FRZ-SV 280	SG-SV 280
S-Vent 280x127-5.5-2D	SI-G 16	SI-F 16	FRZ-SV 280	SG-SV 280
S-Vent 315x143-2.2-6D	SI-G 26	SI-F 26	FRZ-SV 315	SG-SV 315
S-Vent 315x143-4.0-4D	SI-G 26	SI-F 26	FRZ-SV 315	SG-SV 315
S-Vent 355x143-2.2-6D	SI-G 26	SI-F 26	FRZ-SV 355	SG-SV 355
S-Vent 355x143-4.0-4D	SI-G 26	SI-F 26	FRZ-SV 355	SG-SV 355
S-Vent 400x183-1.5-8D	SI-G 35	SI-F 35	FRZ-SV 400	SG-SV 400
S-Vent 400x183-2.2-6D	SI-G 35	SI-F 35	FRZ-SV 400	SG-SV 400
S-Vent 400x183-5.5-4D	SI-G 35	SI-F 35	FRZ-SV 400	SG-SV 400
S-Vent 450x203-3.0-8D	SI-G 50	SI-F 50	FRZ-SV 450	SG-SV 450
S-Vent 450x203-4.0-6D	SI-G 50	SI-F 50	FRZ-SV 450	SG-SV 450
S-Vent 450x203-11.0-4D	SI-G 50	SI-F 50	FRZ-SV 450	SG-SV 450
S-Vent 500x229-5.5-8D	SI-G 75	SI-F 75	FRZ-SV 500	SG-SV 500
S-Vent 500x229-7.5-6D	SI-G 75	SI-F 75	FRZ-SV 500	SG-SV 500
S-Vent 500x229-11.0-4D	SI-G 75	SI-F 75	FRZ-SV 500	SG-SV 500

Tubo-M / Tubo-MZ

Axial inline fans

Use

- Supply and extract ventilation systems installed in various premises.
- Mounting in ventilation systems with low static pressure requiring high air capacity.
- Compatible with \varnothing 100 up to 315 mm round air ducts.



Air flow:
up to 1700 m³/h
472 l/s



Power:
from 26 W



Noise level:
from 31 dBA



Design

- Compact steel casing covered with special polymer coating (**Tubo-M** series) or galvanized steel casing (**Tubo-MZ** series).
- Aluminium impeller.
- The fan is equipped with a power cord and external terminal block for connection to power mains.

Motor

- Single-phase asynchronous external rotor motor with axial impeller.
- Equipped with ball bearings for longer service life.
- Integrated thermal protection with automatic restart.

Speed control

- Smooth speed control with an external thyristor controller or step speed control with an external auto transformer (both available upon separate order).

Mounting

- Mounting in air duct or directly to the wall in any position with respect to air flow direction in the system.
- Power is supplied to the fan through an external terminal box with sealed electric lead-in.
- Wall or ceiling mounting with fixing brackets supplied as a standard.
- Polymer coated or galvanized steel reducers are provided for connection of the **Tubo-M** fans with \varnothing 150 up to 250 mm air ducts. The reducers are not included into delivery list and are available upon separate order.
- Tubo-M 315** and **Tubo-MZ 315** with \varnothing 315 mm air ducts have direct connection.

Designation key

Series	Modifications	Connected air duct diameter [mm]
Tubo-M	Z: galvanized steel	150; 200; 250; 315

Overall dimensions [mm]

Type	\varnothing D	B	L	L1	L2	Weight [kg]
Tubo-M / Tubo-MZ 150	162	183	220	40	30	2.08
Tubo-M / Tubo-MZ 200	208	228	220	40	30	2.54
Tubo-M / Tubo-MZ 250	262	283	270	55	30	3.97
Tubo-M / Tubo-MZ 315	315	337	278	55	40	4.84

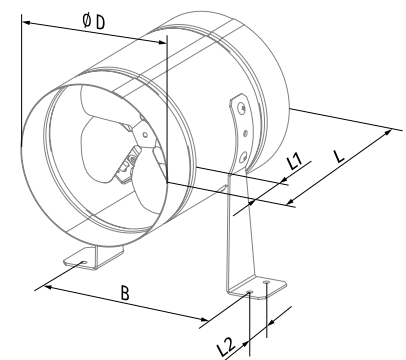

Accessories

Speed controllers



CDT E1.8

Technical data

Parameters	Tubo-M 150 Tubo-MZ 150		Tubo-M 200 Tubo-MZ 200		Tubo-M 250 Tubo-MZ 250		Tubo-M 315 Tubo-MZ 315	
Voltage [V]	1~ 220-240		1~ 220-240		1~ 220-240		1~ 220-240	
Frequency [Hz]	50	60	50	60	50	60	50	60
Power [W]	36	26	43	33	68	76	110	104
Current [A]	0.26	0.26	0.28	0.21	0.48	0.51	0.75	0.7
Maximum air flow [m³/h (l/s)]	200 (56)	205 (57)	405 (113)	470 (131)	1070 (297)	1050 (292)	1700 (472)	1650 (458)
RPM [min⁻¹]	1300	1590	1300	1615	1300	1450	1300	1365
Sound pressure at 3 m [dBA]	33	33	33	33	37	37	42	43
Max. transported air temperature [°C]	-30 ... +40		-30 ... +40		-30 ... +40		-30 ... +40	
IP rating	IPX4		IPX4		IPX4		IPX4	
Motor IP rating	IP44		IP44		IP44		IP44	

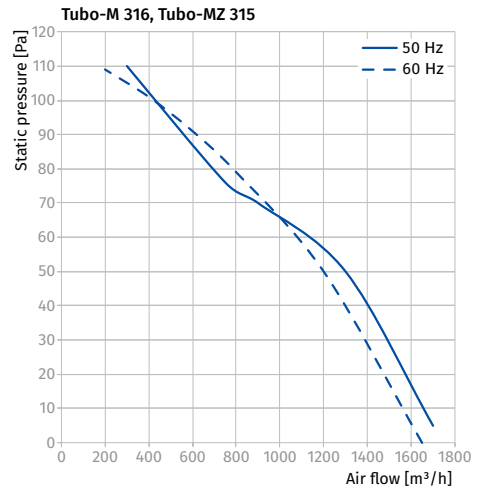
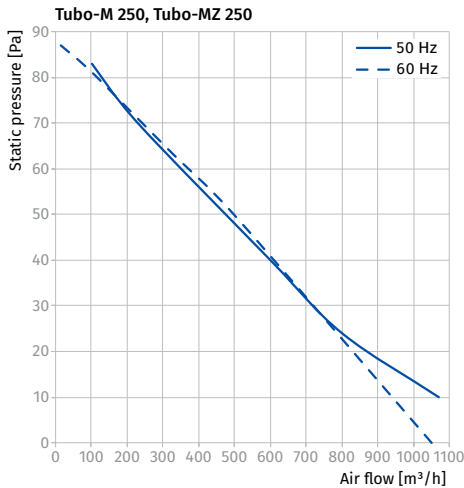
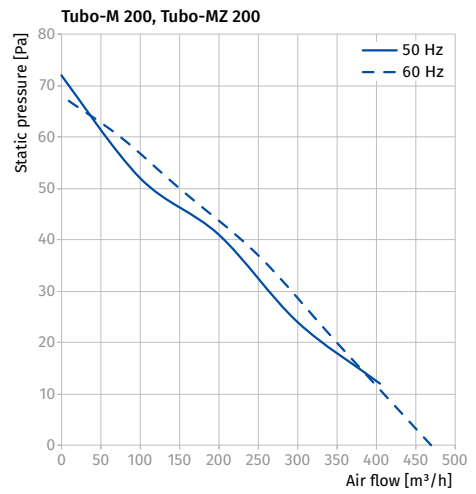
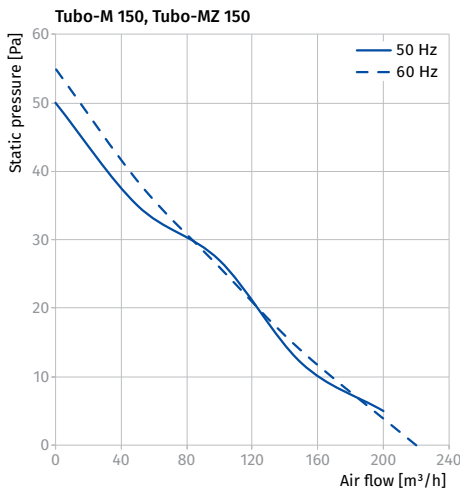

Axis-F

Axial inline fans

Use

- Supply and extract ventilation systems installed in various premises.
- Ideal solution for boosting large air volumes at low aerodynamic resistance in the ventilation system.



Air flow:
up to 25000 m³/h
6945 l/s



Power:
from 50 W



Noise level:
from 38 dBA



Design

- Compact steel casing and impeller with a special polymer coating.
- Casing is equipped with connecting flanges for easy mounting into air duct.
- The fan is equipped with a terminal block for connection to power mains.

Motor

- Two-, four- or six-pole asynchronous motor with external rotor and axial impeller.
- Single-phase (E) or three-phase (D) motor modifications.
- Equipped with ball bearings for longer service life.
- Integrated thermal protection with automatic restart.

Speed control

- Smooth speed control with an external thyristor controller or step speed control with an external auto transformer (both available upon separate order).

Mounting

- The fan is installed in air ducts by connecting flanges on the fan casing.
- Power is supplied through an external terminal box.

AXIAL FANS

Designation key

Series	Dimension type	Motor Number of poles	Phase
Axis-F	200; 250; 300; 350; 400; 450; 500; 550; 630; 710; 800	2; 4; 6	E: single-phase D: three-phase

Accessories

Flexible antivibration connectors	Speed controllers
-----------------------------------	-------------------



EVAF



CDT E1.8

Overall dimensions [mm]

Type	Ø D	Ø D1	Ø D2	Ø d	B	L	Weight [kg]
Axis-F 200 2E	205	235	255	7.0	290	120	3.0
Axis-F 250 2E	260	286	306	7.0	340	150	3.9
Axis-F 250 4E	260	286	306	7.0	340	150	4.0
Axis-F 300 2E	310	356	382	7.0	410	160	6.2
Axis-F 300 4E	310	356	382	7.0	410	160	6.2
Axis-F 350 4E	362	395	421	9.5	450	160	7.7
Axis-F 400 4E	412	438	465	9.5	500	170	8.1
Axis-F 450 4E	462	487	515	9.5	550	200	9.1
Axis-F 500 4E	515	541	570	9.5	600	220	11.0
Axis-F 550 4E	565	605	636	11.5	660	230	13.9
Axis-F 630 4E	645	674	715	11.5	740	250	16.4
Axis-F 250 2D	260	286	306	7.0	340	150	3.9
Axis-F 250 4D	260	286	306	7.0	340	150	4.0
Axis-F 300 2D	310	356	382	7.0	410	160	5.7
Axis-F 300 4D	310	356	382	7.0	410	160	6.2
Axis-F 350 4D	362	395	421	9.5	450	160	7.7
Axis-F 400 4D	412	438	465	9.5	500	170	8.1
Axis-F 450 4D	462	487	515	9.5	550	200	9.1
Axis-F 500 4D	515	541	570	9.5	600	220	11.0
Axis-F 550 4D	565	605	636	11.5	660	230	13.9
Axis-F 630 4D	645	674	715	11.5	740	250	16.4
Axis-F 710 6D	725	767	805	11.5	835	250	30.0
Axis-F 800 6D	800	845	880	11.5	910	280	40.0

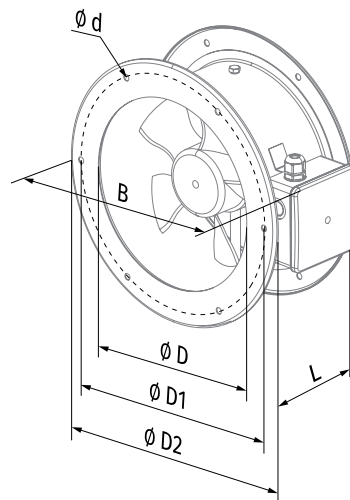

Technical data

Parameters	Axis-F 200 2E		Axis-F 250 2E		Axis-F 250 4E		Axis-F 300 2E		Axis-F 300 4E		Axis-F 350 4E		Axis-F 400 4E	
Voltage [V]	1 ~ 230		1 ~ 230		1 ~ 230		1 ~ 230		1 ~ 230		1 ~ 230		1 ~ 230	
Frequency [Hz]	50	60	50	60	50	60	50	60	50	60	50	60	50	60
Power [W]	55	61	80	91	50	56	145	178	75	92	140	147	180	240
Current [A]	0.26	0.28	0.4	0.42	0.22	0.24	0.66	0.79	0.35	0.4	0.65	0.66	0.82	1.08
Maximum air flow [m³/h (l/s)]	860 (239)	875 (243)	1050 (292)	1150 (319)	800 (222)	865 (240)	2230 (619)	2280 (633)	1340 (372)	1475 (410)	2500 (695)	2650 (736)	3580 (995)	3890 (1081)
RPM [min ⁻¹]	2300	2550	2400	2990	1380	1730	2300	2410	1350	1405	1380	1700	1380	1655
Sound pressure at 3 m [dBA]	48	49	50	51	38	39	53	54	44	45	46	47	53	54
Transported air temperature [°C]	-30...+60		-30...+50		-30...+60		-30...+50		-30...+60		-30...+50		-30...+60	
IP rating	IPX4		IPX4		IPX4		IPX4		IPX4		IPX4		IPX4	
Motor IP rating	IP44		IP44		IP44		IP44		IP44		IP54		IP54	

AXIS-F 200 2E

Sound power level, A-weighted	Total	Octave frequency bands [Hz]								LpA 3 m	LpA 1 m
		63	125	250	500	1000	2000	4000	8000		
LWA to environment [dBA]	68	28	39	52	58	66	62	57	50	48	58

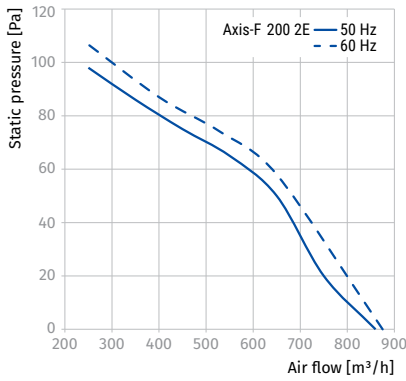

AXIS-F 250 2E, AXIS-F 250 4E

Sound power level, A-weighted	Total	Octave frequency bands [Hz]								LpA 3 m	LpA 1 m
		63	125	250	500	1000	2000	4000	8000		
Axis-F 250 2E											
LWA to environment [dBA]	70	29	40	54	60	68	64	59	52	50	60
Axis-F 250 4E											
LWA to environment [dBA]	59	25	39	43	49	54	54	49	43	38	48

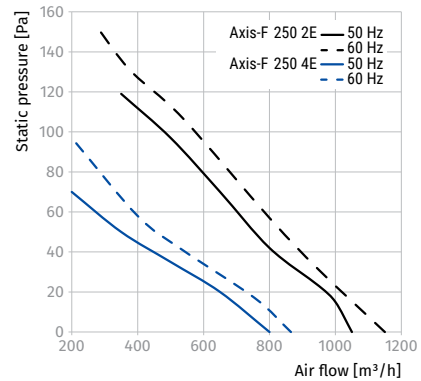

AXIS-F 300 2E, AXIS-F 300 4E

Sound power level, A-weighted	Total	Octave frequency bands [Hz]								LpA 3 m	LpA 1 m
		63	125	250	500	1000	2000	4000	8000		
Axis-F 300 2E											
LWA to environment [dBA]	74	40	49	63	63	71	67	60	56	53	63
Axis-F 300 4E											
LWA to environment [dBA]	64	41	52	47	54	60	60	52	44	44	54

AXIS-F 300 2E

η [%]	MC	EC	N	VSD	[kW]	[A]	[m³/h]	[Pa]	[RPM]	SR
30.5	A	Static	42.2	No	0.141	0.64	1380	110	2350	1

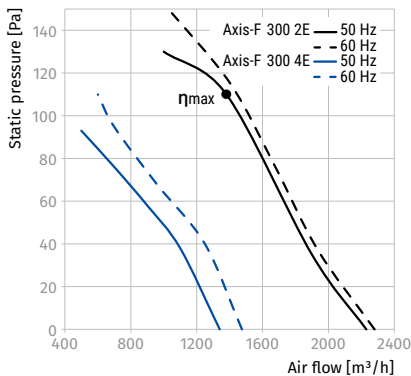

AXIS-F 350 4E, AXIS-F 400 4E

Sound power level, A-weighted	Total	Octave frequency bands [Hz]								LpA 3 m	LpA 1 m
		63	125	250	500	1000	2000	4000	8000		
Axis-F 350 4E											
LWA to environment [dBA]	67	26	43	49	60	62	62	53	46	46	56
Axis-F 400 4E											
LWA to environment [dBA]	73	46	52	58	65	68	68	65	57	53	63

AXIS-F 350 4E

η [%]	MC	EC	N	VSD	[kW]	[A]	[m³/h]	[Pa]	[RPM]	SR
29.9	A	Static	41.8	No	0.130	0.6	1717	80	1375	1

AXIS-F 400 4E

η [%]	MC	EC	N	VSD	[kW]	[A]	[m³/h]	[Pa]	[RPM]	SR
33.8	A	Static	44.8	No	0.187	0.86	2787	80	1355	1

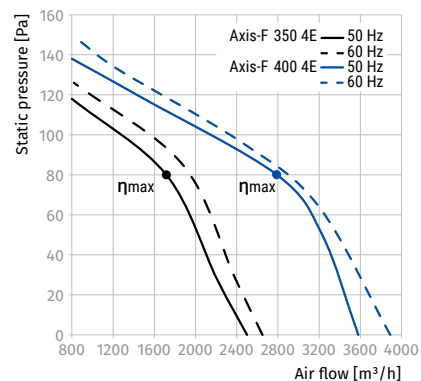

Parameters	Axis-F 450 4E		Axis-F 500 4E		Axis-F 550 4E		Axis-F 630 4E	
Voltage [V]	1 ~ 230		1 ~ 230		1 ~ 230		1 ~ 230	
Frequency [Hz]	50	60	50	60	50	60	50	60
Power [W]	250	325	420	455	550	654	750	979
Current [A]	1.2	1.46	1.95	2.05	2.55	2.88	3.5	4.26
Maximum air flow [m³/h (l/s)]	4680 (1300)	4790 (1331)	7060 (1961)	7130 (1981)	8800 (2445)	8970 (2492)	11900 (3306)	12100 (3361)
RPM [min⁻¹]	1350	1600	1300	1630	1300	1580	1360	1625
Sound pressure at 3 m [dBA]	56	57	58	59	62	63	67	68
Transported air temperature [°C]	-30...+60		-30...+60		-30...+60		-30...+60	
IP rating	IPX4		IPX4		IPX4		IPX4	
Motor IP rating	IP54		IP54		IP54		IP54	

AXIS-F 450 4E

Sound power level, A-weighted	Total	Octave frequency bands [Hz]								LpA 3 m	LpA 1 m
		63	125	250	500	1000	2000	4000	8000		
LWA to environment [dBA]	76	46	57	64	70	72	70	66	58	56	66
η [%]	MC	EC	N	VSD	[kW]	[A]	[m³/h]	[Pa]	[RPM]	SR	
32.0	A	Static	41.8	No	0.288	1.31	3610	90	1270	1	

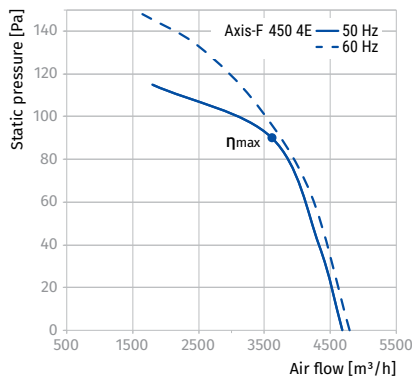

AXIS-F 500 4E

Sound power level, A-weighted	Total	Octave frequency bands [Hz]								LpA 3 m	LpA 1 m
		63	125	250	500	1000	2000	4000	8000		
LWA to environment [dBA]	79	49	60	67	73	74	73	68	60	58	68
η [%]	MC	EC	N	VSD	[kW]	[A]	[m³/h]	[Pa]	[RPM]	SR	
32.1	A	Static	40.7	No	0.440	2.01	4987	100	1285	1	

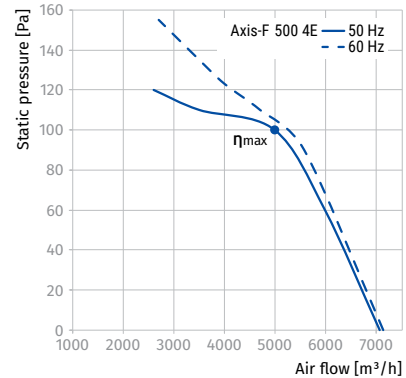

AXIS-F 550 4E

Sound power level, A-weighted	Total	Octave frequency bands [Hz]								LpA 3 m	LpA 1 m
		63	125	250	500	1000	2000	4000	8000		
LWA to environment [dBA]	83	52	64	71	77	78	77	72	64	62	72
η [%]	MC	EC	N	VSD	[kW]	[A]	[m³/h]	[Pa]	[RPM]	SR	
34.7	A	Static	42.6	No	0.581	2.64	5919	120	1240	1	

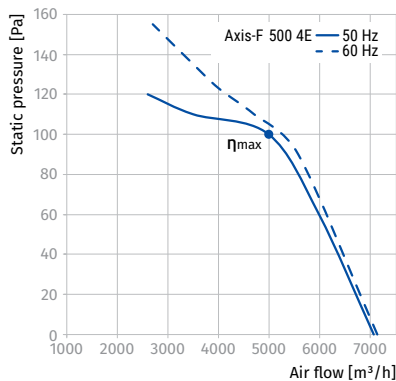

AXIS-F 630 4E

Sound power level, A-weighted	Total	Octave frequency bands [Hz]								LpA 3 m	LpA 1 m
		63	125	250	500	1000	2000	4000	8000		
LWA to environment [dBA]	88	57	68	76	81	83	82	77	69	67	77
η [%]	MC	EC	N	VSD	[kW]	[A]	[m³/h]	[Pa]	[RPM]	SR	
37.5	A	Static	44.4	No	0.800	3.76	7095	149	1290	1	

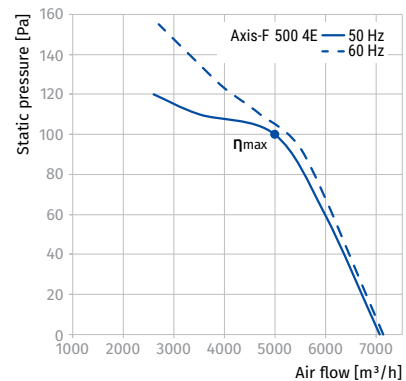

AXIAL FANS

Parameters	Axis-F 250 2D		Axis-F 250 4D		Axis-F 300 2D		Axis-F 300 4D	
Voltage [V]	3 ~ 400		3 ~ 400		3 ~ 400		3 ~ 400	
Frequency [Hz]	50	60	50	60	50	60	50	60
Power [W]	80	92	60	89	145	165	75	94
Current [A]	0.22	0.24	0.17	0.22	0.25	0.29	0.22	0.25
Maximum air flow [m ³ /h (l/s)]	1060 (294)	1150 (319)	850 (236)	885 (246)	2310 (642)	2390 (664)	1310 (364)	1530 (425)
RPM [min ⁻¹]	2600	3030	1400	1750	2350	2570	1380	1640
Sound pressure at 3 m [dBA]	51	52	38	38	52	52	45	45
Transported air temperature [°C]	-30...+60		-30...+60		-30...+60		-30...+60	
IP rating	IPX4		IPX4		IPX4		IPX4	
Motor IP rating	IP44		IP44		IP44		IP44	

AXIS-F 250 2D, AXIS-F 250 4D

Sound power level, A-weighted	Total	Octave frequency bands [Hz]								LpA 3 m	LpA 1 m
		63	125	250	500	1000	2000	4000	8000		
Axis-F 250 2D											
LWA to environment [dBA]	71	29	41	55	61	69	65	60	52	51	61
Axis-F 250 4D											
LWA to environment [dBA]	59	25	39	43	49	54	54	49	43	38	48

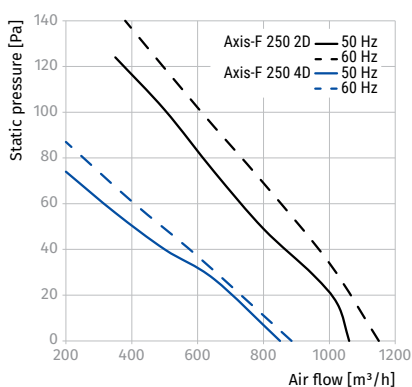
AXIS-F 300 2D, AXIS-F 300 4D

Sound power level, A-weighted	Total	Octave frequency bands [Hz]								LpA 3 m	LpA 1 m
		63	125	250	500	1000	2000	4000	8000		
Axis-F 300 2D											
LWA to environment [dBA]	73	39	48	62	62	70	66	60	55	52	62
Axis-F 300 4D											
LWA to environment [dBA]	65	42	53	46	55	61	61	53	44	45	55

AXIS-F 300 2D

η [%]	MC	EC	N	VSD	[kW]	[A]	[m ³ /h]	[Pa]	[RPM]	SR
30.3	A	Static	42	No	0.141	0.25	1367	110	2350	1

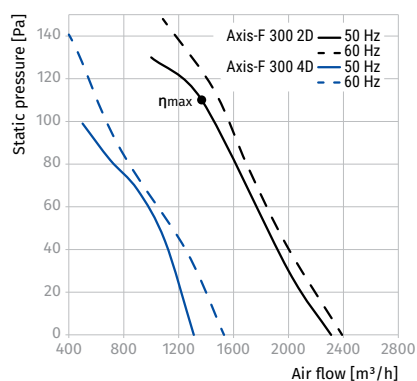

Parameters	Axis-F 350 4D		Axis-F 400 4D		Axis-F 450 4D	
Voltage [V]	3 ~ 400		3 ~ 400		3 ~ 400	
Frequency [Hz]	50	60	50	60	50	60
Power [W]	140	150	180	195	250	275
Current [A]	0.38	0.46	0.47	0.55	0.6	0.65
Maximum air flow [m³/h (l/s)]	2350 (653)	2660 (739)	3740 (1039)	3870 (1075)	5280 (1467)	5350 (1486)
RPM [min⁻¹]	1419	1638	1380	1625	1360	1620
Sound pressure at 3 m [dBA]	46	46	54	54	56	56
Transported air temperature [°C]	-30...+60		-30...+60		-30...+60	
IP rating	IPX4		IPX4		IPX4	
Motor IP rating	IP54		IP54		IP54	

AXIS-F 350 4D, AXIS-F 400 4D

Sound power level, A-weighted	Total	Octave frequency bands [Hz]								LpA 3 m	LpA 1 m
		63	125	250	500	1000	2000	4000	8000		
Axis-F 350 4D											
LWA to environment [dBA]	66	26	43	48	59	62	62	53	46	46	56
Axis-F 400 4D											
LWA to environment [dBA]	74	31	48	58	63	70	70	66	58	54	64

AXIS-F 350 4D

η [%]	MC	EC	N	VSD	[kW]	[A]	[m³/h]	[Pa]	[RPM]	SR
31.7	A	Static	43.7	No	0.129	0.37	1802	80	1400	1

AXIS-F 400 4D

η [%]	MC	EC	N	VSD	[kW]	[A]	[m³/h]	[Pa]	[RPM]	SR
34.3	A	Static	44.9	No	0.209	0.47	2807	90	1365	1

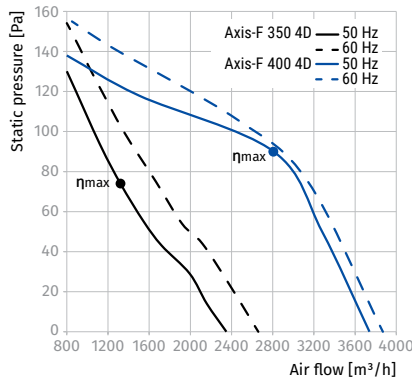

AXIS-F 450 4D

Sound power level, A-weighted	Total	Octave frequency bands [Hz]								LpA 3 m	LpA 1 m
		63	125	250	500	1000	2000	4000	8000		
LWA to environment [dBA]	77	48	60	67	70	71	72	67	59	56	66
η [%]	MC	EC	N	VSD	[kW]	[A]	[m³/h]	[Pa]	[RPM]	SR	
35.1	A	Static	44.8	No	0.296	0.59	3659	100	1310	1	

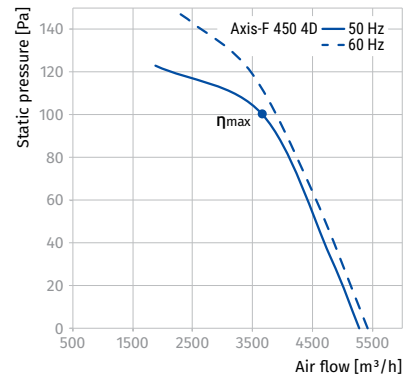

Parameters	Axis-F 500 4D		Axis-F 550 4D		Axis-F 630 4D		Axis-F 710 6D
Voltage [V]	3 ~ 400		3 ~ 400		3 ~ 400		3 ~ 400
Frequency [Hz]	50	60	50	60	50	60	50
Power [W]	450	370	750	600	800	910	1150
Current [A]	0.9	0.7	1.5	1.1	1.6	1.68	2.0
Maximum air flow [m³/h (l/s)]	6570 (1825)	6230 (1731)	9700 (2695)	7380 (2050)	12200 (3389)	12400 (3445)	15440 (4289)
RPM [min ⁻¹]	1300	1605	1350	1605	1320	1585	830
Sound pressure at 3 m [dBA]	60		64		69		63
Transported air temperature [°C]	-30...+60	-30...+50	-30...+60	-30...+50	-30...+60	-30...+50	-30...+60
IP rating	IPX4		IPX4		IPX4		IPX4
Motor IP rating	IP54		IP54		IP54		IP54

AXIS-F 500 4D

Sound power level, A-weighted	Total	Octave frequency bands [Hz]								LpA 3 m	LpA 1 m
		63	125	250	500	1000	2000	4000	8000		
L _{WA} to environment [dBA]	81	51	63	70	74	75	76	71	62	60	70
η [%]	MC	EC	N	VSD	[kW]	[A]	[m³/h]	[Pa]	[RPM]	SR	
35.5	A	Static	43.9	No	0.478	0.9	4988	120	1305	1	

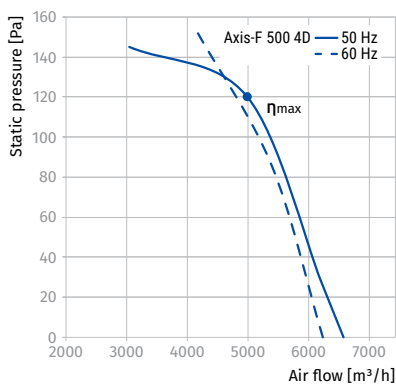

AXIS-F 550 4D

Sound power level, A-weighted	Total	Octave frequency bands [Hz]								LpA 3 m	LpA 1 m
		63	125	250	500	1000	2000	4000	8000		
L _{WA} to environment [dBA]	85	53	65	72	79	80	79	73	65	64	74
η [%]	MC	EC	N	VSD	[kW]	[A]	[m³/h]	[Pa]	[RPM]	SR	
38.8	A	Static	46.3	No	0.656	1.27	6400	140	1175	1	

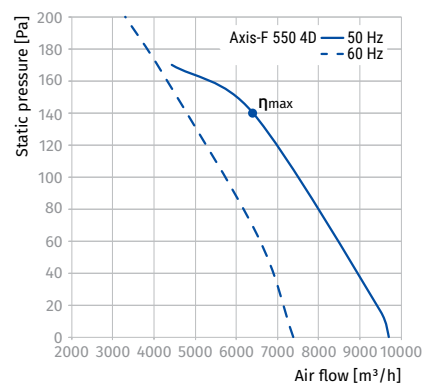

AXIS-F 630 4D

Sound power level, A-weighted	Total	Octave frequency bands [Hz]								LpA 3 m	LpA 1 m
		63	125	250	500	1000	2000	4000	8000		
L _{WA} to environment [dBA]	90	58	69	78	83	85	84	79	70	69	79
η [%]	MC	EC	N	VSD	[kW]	[A]	[m³/h]	[Pa]	[RPM]	SR	
41.2	A	Static	48.1	No	0.810	1.61	7743	152	1290	1	

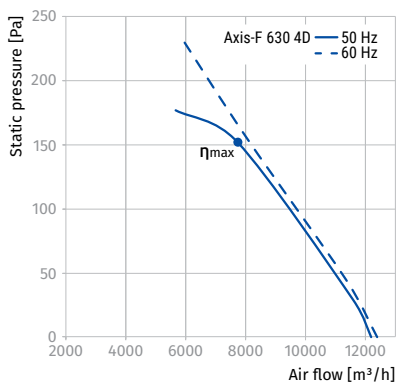

AXIS-F 710 6D

Sound power level, A-weighted	Total	Octave frequency bands [Hz]								LpA 3 m	LpA 1 m
		63	125	250	500	1000	2000	4000	8000		
L _{WA} to environment [dBA]	83	54	65	72	78	79	77	70	62	63	73
η [%]	MC	EC	N	VSD	[kW]	[A]	[m³/h]	[Pa]	[RPM]	SR	
35.6	A	Static	42	No	0.979	1.91	8777	140	830	1	

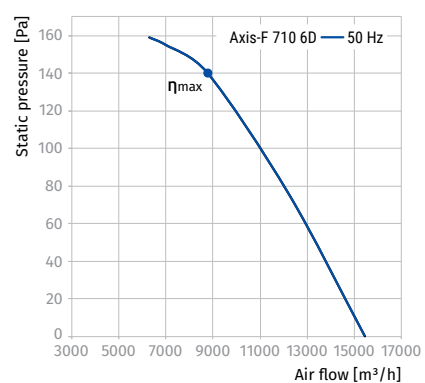

Parameters	Axis-F 800 6D
Voltage [V]	3 ~ 400
Frequency [Hz]	50
Power [W]	1850
Current [A]	3.7
Maximum air flow [m³/h (l/s)]	25000 (6945)
RPM [min ⁻¹]	915
Sound pressure at 3 m [dBA]	67
Transported air temperature [°C]	-30...+60
IP rating	IPX4
Motor IP rating	IP54

AXIS-F 800 6D

Sound power level, A-weighted	Total	Octave frequency bands [Hz]								LpA 3 m	LpA 1 m
		63	125	250	500	1000	2000	4000	8000		
L _{WA} to environment [dBA]	88	57	69	77	82	83	81	74	65	67	77

η [%]	MC	EC	N	VSD	[kW]	[A]	[m³/h]	[Pa]	[RPM]	SR
31.6	A	Static	36.6	No	1.650	3.6	17040	108	915	1

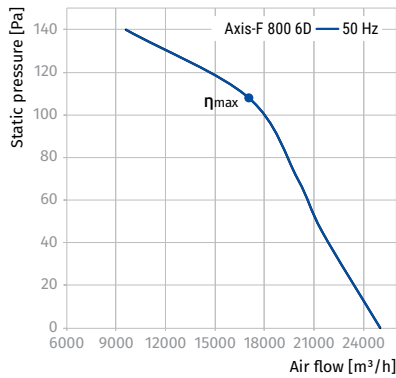

Axis-Q

Axial wall fans

Use

- Supply and extract ventilation systems installed in various premises.
- Ideal solution for boosting large air volumes at low aerodynamic resistance in the ventilation system.
- Refrigerating technologies for cooling of compressor condensing units.
- Direct air extract.
- For positive pressure ventilation in fire-fighting systems.



Air flow:
up to 25000 m³/h
6945 l/s



Power:
from 50 W



Noise level:
from 38 dBA



Design

- Steel casing and impeller with a special polymer atmospheric resistant coating.
- Casing is equipped with a square mounting plate and a round flange to facilitate wall mounting.
- The fan is equipped with a terminal box for connection to power mains.

Motor

- Two-, four- or six-pole asynchronous motor with external rotor and axial impeller.
- Single-phase (E) or three-phase (D) motor modifications.
- Equipped with ball bearings for longer service life.
- Integrated overheating protection with automatic restart.

Speed control

- Smooth speed control with an external thyristor controller or step speed control with an external auto transformer (both available upon separate order).

Mounting

- Wall surface mounting with a square connecting frame.
- Any mounting position with respect to air flow direction in the system.
- Power is supplied through an external terminal box.

Designation key

Series	Dimension type	Motor Number of poles	Phase
Axis-Q	200; 250; 300; 350; 400; 450; 500; 550; 630; 710; 800	2; 4; 6	E: single-phase D: three-phase

Accessories

Flexible antivibration connectors

Speed controllers



EVAF



CDT E1.8

Overall dimensions [mm]

Type	Ø D	Ø d	B	B1	L	Weight [kg]
Axis-Q 200 2E	210	7	312	260	125	3.0
Axis-Q 250 2E	260	7	370	320	135	4.0
Axis-Q 250 4E	260	7	370	320	135	3.5
Axis-Q 300 2E	317	9	430	380	145	6.1
Axis-Q 300 4E	317	9	430	380	145	5.0
Axis-Q 350 4E	374	9	485	435	165	7.8
Axis-Q 400 4E	416	9	540	490	220	8.8
Axis-Q 450 4E	465	11	576	535	230	10.5
Axis-Q 500 4E	520	11	655	615	250	14.0
Axis-Q 550 4E	570	11	725	675	260	16.5
Axis-Q 630 4E	650	11	800	710	275	20.0
Axis-Q 250 2D	260	7	370	320	135	4.0
Axis-Q 250 4D	260	7	370	320	135	3.5
Axis-Q 300 2D	317	9	430	380	145	5.4
Axis-Q 300 4D	317	9	430	380	145	5.4
Axis-Q 350 4D	374	9	485	435	165	7.8
Axis-Q 400 4D	416	9	540	490	220	8.8
Axis-Q 450 4D	465	11	576	535	230	10.5
Axis-Q 500 4D	520	11	655	615	250	14.0
Axis-Q 550 4D	570	11	725	675	260	16.5
Axis-Q 630 4D	650	11	800	710	275	20.0
Axis-Q 710 6D	725	13	900	810	350	33.0
Axis-Q 800 6D	800	13	970	910	350	44.0

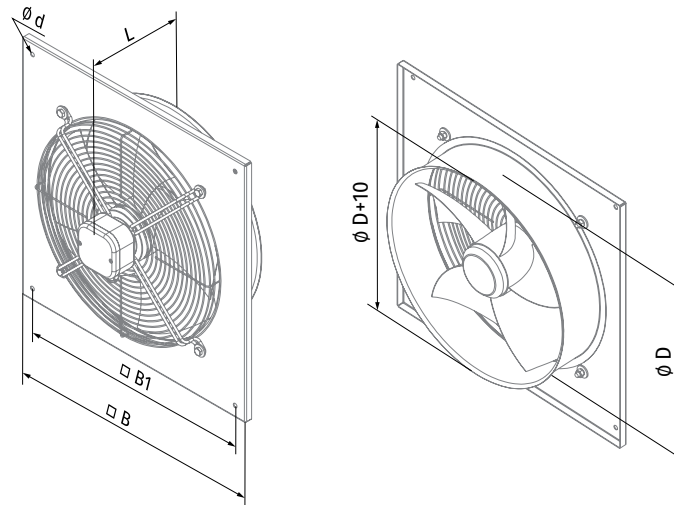

Technical data

Parameters	Axis-Q 200 2E		Axis-Q 250 2E		Axis-Q 250 4E		Axis-Q 300 2E		Axis-Q 300 4E		Axis-Q 350 4E		Axis-Q 400 4E	
Voltage [V]	1 ~ 230		1 ~ 230		1 ~ 230		1 ~ 230		1 ~ 230		1 ~ 230		1 ~ 230	
Frequency [Hz]	50	60	50	60	50	60	50	60	50	60	50	60	50	60
Power [W]	55	61	80	91	50	56	145	178	75	92	140	147	180	240
Current [A]	0.26	0.28	0.4	0.42	0.22	0.24	0.66	0.79	0.35	0.4	0.65	0.66	0.82	1.08
Maximum air flow [m³/h (l/s)]	860 (239)	875 (243)	1050 (292)	1150 (319)	800 (222)	865 (240)	2230 (619)	2280 (633)	1340 (372)	1475 (410)	2500 (695)	2650 (736)	3580 (995)	3890 (1081)
RPM [min ⁻¹]	2300	2550	2400	2990	1380	1730	2300	2410	1350	1405	1380	1700	1380	1655
Sound pressure at 3 m [dBA]	48	49	50	51	38	39	53	54	44	45	46	47	53	54
Transported air temperature [°C]	-30...+60		-30...+50		-30...+60		-30...+50		-30...+60		-30...+50		-30...+60	
IP rating	IPX4		IPX4		IPX4		IPX4		IPX4		IPX4		IPX4	
Motor IP rating	IP44		IP44		IP44		IP44		IP44		IP54		IP54	

AXIS-Q 200 2E

Sound power level, A-weighted	Total	Octave frequency bands [Hz]								LpA 3 m	LpA 1 m
		63	125	250	500	1000	2000	4000	8000		
LWA to environment [dBA]	68	28	39	52	58	66	62	57	50	48	58

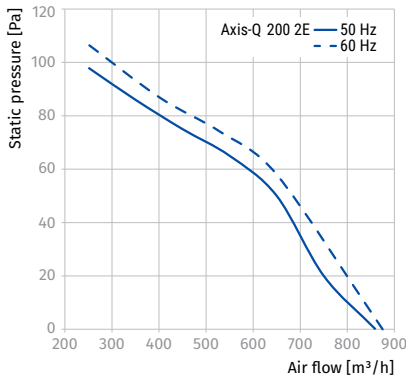

AXIS-Q 250 2E, AXIS-Q 250 4E

Sound power level, A-weighted	Total	Octave frequency bands [Hz]								LpA 3 m	LpA 1 m
		63	125	250	500	1000	2000	4000	8000		
LWA to environment [dBA]	70	29	40	54	60	68	64	59	52	50	60

Axis-Q 250 2E											
LWA to environment [dBA]	70	29	40	54	60	68	64	59	52	50	60

Axis-Q 250 4E											
LWA to environment [dBA]	59	25	39	43	49	54	54	49	43	38	48

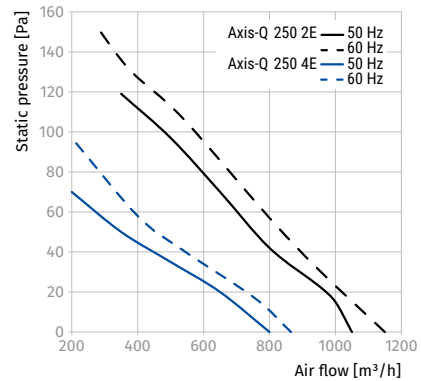

AXIS-Q 300 2E, AXIS-Q 300 4E

Sound power level, A-weighted	Total	Octave frequency bands [Hz]								LpA 3 m	LpA 1 m
		63	125	250	500	1000	2000	4000	8000		
LWA to environment [dBA]	74	40	49	63	63	71	67	60	56	53	63

Axis-Q 300 2E											
LWA to environment [dBA]	74	40	49	63	63	71	67	60	56	53	63

Axis-Q 300 4E											
LWA to environment [dBA]	64	41	52	47	54	60	60	52	44	44	54

AXIS-Q 300 2E

η [%]	MC	EC	N	VSD	[kW]	[A]	[m³/h]	[Pa]	[RPM]	SR
30.5	A	Static	42.2	No	0.141	0.64	1380	110	2350	1

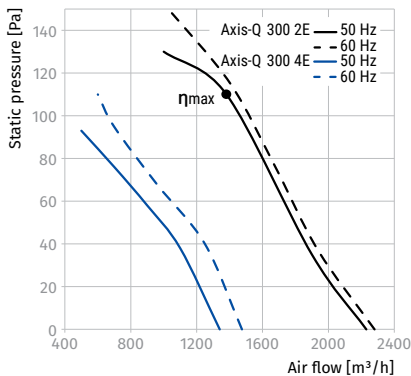

AXIS-Q 350 4E, AXIS-Q 400 4E

Sound power level, A-weighted	Total	Octave frequency bands [Hz]								LpA 3 m	LpA 1 m
		63	125	250	500	1000	2000	4000	8000		
LWA to environment [dBA]	67	26	43	49	60	62	62	53	46	46	56

Axis-Q 350 4E											
LWA to environment [dBA]	67	26	43	49	60	62	62	53	46	46	56

Axis-Q 400 4E											
LWA to environment [dBA]	73	46	52	58	65	68	68	65	57	53	63

AXIS-Q 350 4E

η [%]	MC	EC	N	VSD	[kW]	[A]	[m³/h]	[Pa]	[RPM]	SR
29.9	A	Static	41.8	No	0.130	0.6	1717	80	1375	1

AXIS-Q 400 4E

η [%]	MC	EC	N	VSD	[kW]	[A]	[m³/h]	[Pa]	[RPM]	SR
33.8	A	Static	44.8	No	0.187	0.86	2787	80	1355	1

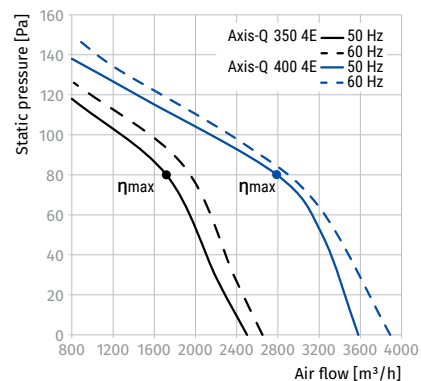

Parameters	Axis-Q 450 4E		Axis-Q 500 4E		Axis-Q 550 4E		Axis-Q 630 4E	
Voltage [V]	1 ~ 230		1 ~ 230		1 ~ 230		1 ~ 230	
Frequency [Hz]	50	60	50	60	50	60	50	60
Power [W]	250	325	420	455	550	654	750	979
Current [A]	1.2	1.46	1.95	2.05	2.55	2.88	3.5	4.26
Maximum air flow [m³/h (l/s)]	4680 (1300)	4790 (1331)	7060 (1961)	7130 (1981)	8800 (2445)	8970 (2492)	11900 (3306)	12100 (3361)
RPM [min⁻¹]	1350	1600	1300	1630	1300	1580	1360	1625
Sound pressure at 3 m [dBA]	56	57	58	59	62	63	67	68
Transported air temperature [°C]	-30...+60		-30...+60		-30...+60		-30...+60	
IP rating	IPX4		IPX4		IPX4		IPX4	
Motor IP rating	IP54		IP54		IP54		IP54	

AXIS-Q 450 4E

Sound power level, A-weighted	Total	Octave frequency bands [Hz]								LpA 3 m	LpA 1 m
		63	125	250	500	1000	2000	4000	8000		
LWA to environment [dBA]	76	46	57	64	70	72	70	66	58	56	66
η [%]	MC	EC	N	VSD	[kW]	[A]	[m³/h]	[Pa]	[RPM]	SR	
32.0	A	Static	41.8	No	0.288	1.31	3610	90	1270	1	

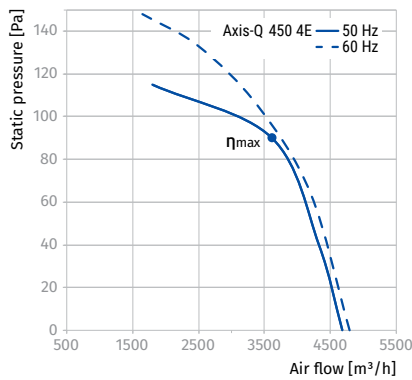

AXIS-Q 500 4E

Sound power level, A-weighted	Total	Octave frequency bands [Hz]								LpA 3 m	LpA 1 m
		63	125	250	500	1000	2000	4000	8000		
LWA to environment [dBA]	79	49	60	67	73	74	73	68	60	58	68
η [%]	MC	EC	N	VSD	[kW]	[A]	[m³/h]	[Pa]	[RPM]	SR	
32.1	A	Static	40.7	No	0.440	2.01	4987	100	1285	1	

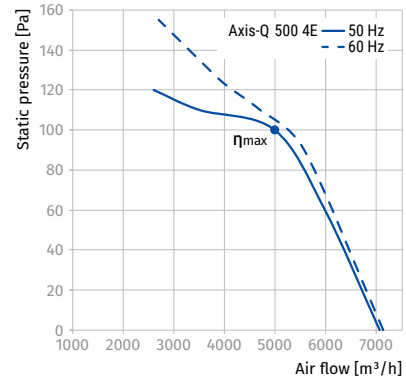

AXIS-Q 550 4E

Sound power level, A-weighted	Total	Octave frequency bands [Hz]								LpA 3 m	LpA 1 m
		63	125	250	500	1000	2000	4000	8000		
LWA to environment [dBA]	83	52	64	71	77	78	77	72	64	62	72
η [%]	MC	EC	N	VSD	[kW]	[A]	[m³/h]	[Pa]	[RPM]	SR	
34.7	A	Static	42.6	No	0.581	2.64	5919	120	1240	1	

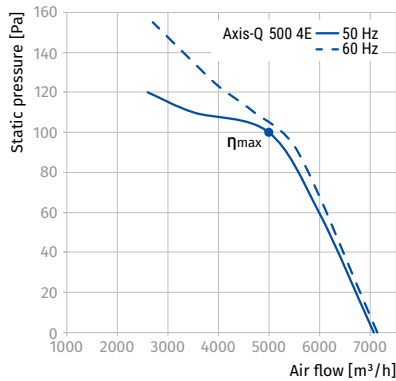

AXIS-Q 630 4E

Sound power level, A-weighted	Total	Octave frequency bands [Hz]								LpA 3 m	LpA 1 m
		63	125	250	500	1000	2000	4000	8000		
LWA to environment [dBA]	88	57	68	76	81	83	82	77	69	67	77
η [%]	MC	EC	N	VSD	[kW]	[A]	[m³/h]	[Pa]	[RPM]	SR	
37.5	A	Static	44.4	No	0.800	3.76	7095	149	1290	1	

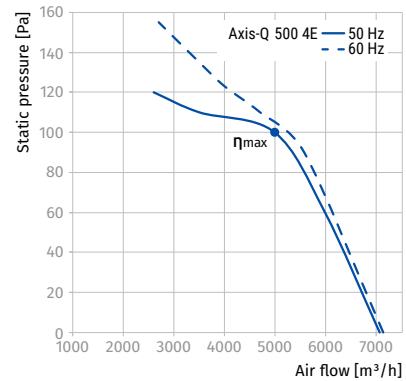

AXIAL FANS

Parameters	Axis-Q 250 2D		Axis-Q 250 4D		Axis-Q 300 2D		Axis-Q 300 4D	
Voltage [V]	3 ~ 400		3 ~ 400		3 ~ 400		3 ~ 400	
Frequency [Hz]	50	60	50	60	50	60	50	60
Power [W]	80	92	60	89	145	165	75	94
Current [A]	0.22	0.24	0.17	0.22	0.25	0.29	0.22	0.25
Maximum air flow [m ³ /h (l/s)]	1060 (294)	1150 (319)	850 (236)	885 (246)	2310 (642)	2390 (664)	1310 (364)	1530 (425)
RPM [min ⁻¹]	2600	3030	1400	1750	2350	2570	1380	1640
Sound pressure at 3 m [dBA]	51	52	38	38	52	52	45	45
Transported air temperature [°C]	-30...+60		-30...+60		-30...+60		-30...+60	
IP rating	IPX4		IPX4		IPX4		IPX4	
Motor IP rating	IP44		IP44		IP44		IP44	

AXIS-Q 250 2D, AXIS-Q 250 4D

Sound power level, A-weighted	Total	Octave frequency bands [Hz]								LpA 3 m	LpA 1 m
		63	125	250	500	1000	2000	4000	8000		
Axis-Q 250 2D											
LWA to environment [dBA]	71	29	41	55	61	69	65	60	52	51	61
Axis-Q 250 4D											
LWA to environment [dBA]	59	25	39	43	49	54	54	49	43	38	48

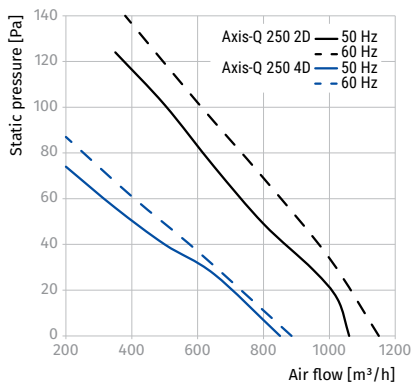
AXIS-Q 300 2D, AXIS-Q 300 4D

Sound power level, A-weighted	Total	Octave frequency bands [Hz]								LpA 3 m	LpA 1 m
		63	125	250	500	1000	2000	4000	8000		
Axis-Q 300 2D											
LWA to environment [dBA]	73	39	48	62	62	70	66	60	55	52	62
Axis-Q 300 4D											
LWA to environment [dBA]	65	42	53	46	55	61	61	53	44	45	55

AXIS-Q 300 2D

η [%]	MC	EC	N	VSD	[kW]	[A]	[m ³ /h]	[Pa]	[RPM]	SR
30.3	A	Static	42	No	0.141	0.25	1367	110	2350	1

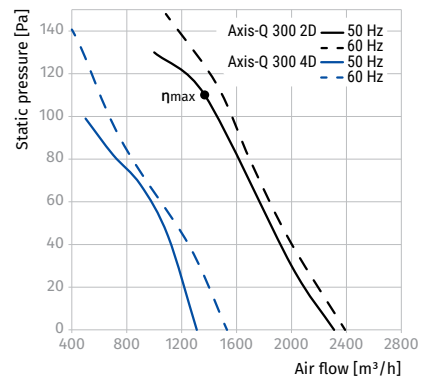

Parameters	Axis-Q 350 4D		Axis-Q 400 4D		Axis-Q 450 4D	
Voltage [V]	3 ~ 400		3 ~ 400		3 ~ 400	
Frequency [Hz]	50	60	50	60	50	60
Power [W]	140	150	180	195	250	275
Current [A]	0.38	0.46	0.47	0.55	0.6	0.65
Maximum air flow [m³/h (l/s)]	2350 (653)	2660 (739)	3740 (1039)	3870 (1075)	5280 (1467)	5350 (1486)
RPM [min⁻¹]	1419	1638	1380	1625	1360	1620
Sound pressure at 3 m [dBA]	46	46	54	54	56	56
Transported air temperature [°C]	-30...+60		-30...+60		-30...+60	
IP rating	IPX4		IPX4		IPX4	
Motor IP rating	IP54		IP54		IP54	

AXIS-Q 350 4D, AXIS-Q 400 4D

Sound power level, A-weighted	Total	Octave frequency bands [Hz]								LpA 3 m	LpA 1 m
		63	125	250	500	1000	2000	4000	8000		
Axis-Q 350 4D											
LWA to environment [dBA]	66	26	43	48	59	62	62	53	46	46	56
Axis-Q 400 4D											
LWA to environment [dBA]	74	31	48	58	63	70	70	66	58	54	64

AXIS-Q 350 4D

η [%]	MC	EC	N	VSD	[kW]	[A]	[m³/h]	[Pa]	[RPM]	SR
31.7	A	Static	43.7	No	0.129	0.37	1802	80	1400	1

AXIS-Q 400 4D

η [%]	MC	EC	N	VSD	[kW]	[A]	[m³/h]	[Pa]	[RPM]	SR
34.3	A	Static	44.9	No	0.209	0.47	2807	90	1365	1

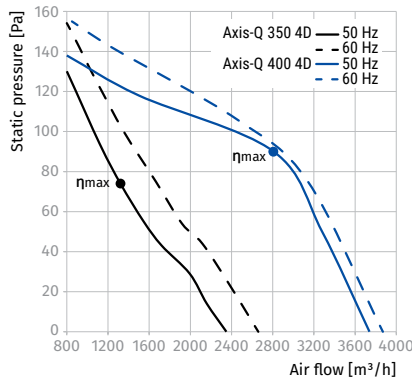

AXIS-Q 450 4D

Sound power level, A-weighted	Total	Octave frequency bands [Hz]								LpA 3 m	LpA 1 m
		63	125	250	500	1000	2000	4000	8000		
LWA to environment [dBA]	77	48	60	67	70	71	72	67	59	56	66
η [%]	MC	EC	N	VSD	[kW]	[A]	[m³/h]	[Pa]	[RPM]	SR	
35.1	A	Static	44.8	No	0.296	0.59	3659	100	1310	1	

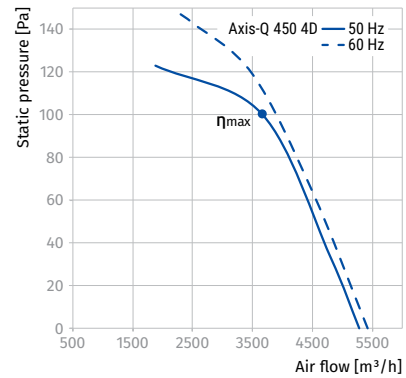

Parameters	Axis-Q 500 4D		Axis-Q 550 4D		Axis-Q 630 4D		Axis-Q 710 6D
Voltage [V]	3 ~ 400		3 ~ 400		3 ~ 400		3 ~ 400
Frequency [Hz]	50	60	50	60	50	60	50
Power [W]	450	370	750	600	800	910	1150
Current [A]	0.9	0.7	1.5	1.1	1.6	1.68	2.0
Maximum air flow [m³/h (l/s)]	6570 (1825)	6230 (1731)	9700 (2695)	7380 (2050)	12200 (3389)	12400 (3445)	15440 (4289)
RPM [min ⁻¹]	1300	1605	1350	1605	1320	1585	830
Sound pressure at 3 m [dBA]	60		64		69		63
Transported air temperature [°C]	-30...+60		-30...+50		-30...+60		-30...+50
IP rating	IPX4		IPX4		IPX4		IPX4
Motor IP rating	IP54		IP54		IP54		IP54

AXIS-Q 500 4D

Sound power level, A-weighted	Total	Octave frequency bands [Hz]								LpA 3 m	LpA 1 m
		63	125	250	500	1000	2000	4000	8000		
L _{WA} to environment [dBA]	81	51	63	70	74	75	76	71	62	60	70
η [%]	MC	EC	N	VSD	[kW]	[A]	[m³/h]	[Pa]	[RPM]	SR	
35.5	A	Static	43.9	No	0.478	0.9	4988	120	1305	1	

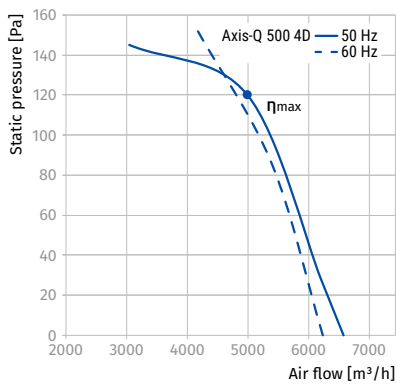

AXIS-Q 550 4D

Sound power level, A-weighted	Total	Octave frequency bands [Hz]								LpA 3 m	LpA 1 m
		63	125	250	500	1000	2000	4000	8000		
L _{WA} to environment [dBA]	85	53	65	72	79	80	79	73	65	64	74
η [%]	MC	EC	N	VSD	[kW]	[A]	[m³/h]	[Pa]	[RPM]	SR	
38.8	A	Static	46.3	No	0.656	1.27	6400	140	1175	1	

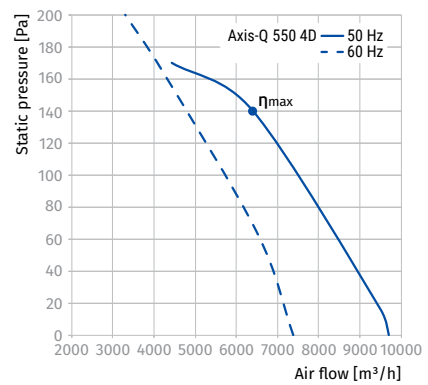

AXIS-Q 630 4D

Sound power level, A-weighted	Total	Octave frequency bands [Hz]								LpA 3 m	LpA 1 m
		63	125	250	500	1000	2000	4000	8000		
L _{WA} to environment [dBA]	90	58	69	78	83	85	84	79	70	69	79
η [%]	MC	EC	N	VSD	[kW]	[A]	[m³/h]	[Pa]	[RPM]	SR	
41.2	A	Static	48.1	No	0.810	1.61	7743	152	1290	1	

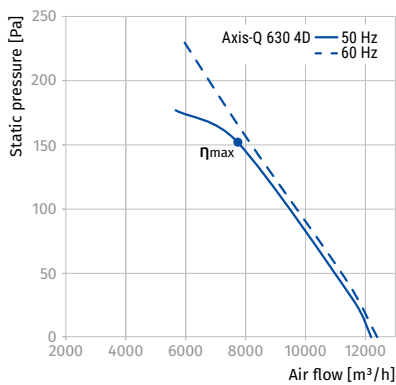

AXIS-Q 710 6D

Sound power level, A-weighted	Total	Octave frequency bands [Hz]								LpA 3 m	LpA 1 m
		63	125	250	500	1000	2000	4000	8000		
L _{WA} to environment [dBA]	83	54	65	72	78	79	77	70	62	63	73
η [%]	MC	EC	N	VSD	[kW]	[A]	[m³/h]	[Pa]	[RPM]	SR	
35.6	A	Static	42	No	0.979	1.91	8777	140	830	1	

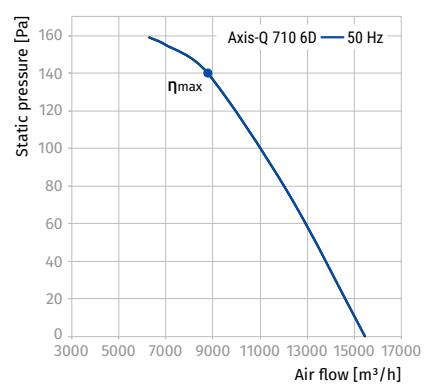

Parameters	Axis-Q 800 6D
Voltage [V]	3 ~ 400
Frequency [Hz]	50
Power [W]	1850
Current [A]	3.7
Maximum air flow [m³/h (l/s)]	25000 (6945)
RPM [min ⁻¹]	915
Sound pressure at 3 m [dBA]	67
Transported air temperature [°C]	-30...+60
IP rating	IPX4
Motor IP rating	IP54

AXIS-Q 800 6D

Sound power level, A-weighted	Total	Octave frequency bands [Hz]								LpA 3 m	LpA 1 m
		63	125	250	500	1000	2000	4000	8000		
L _{WA} to environment [dBA]	88	57	69	77	82	83	81	74	65	67	77

η [%]	MC	EC	N	VSD	[kW]	[A]	[m³/h]	[Pa]	[RPM]	SR
31.6	A	Static	36.6	No	1.650	3.6	17040	108	915	1

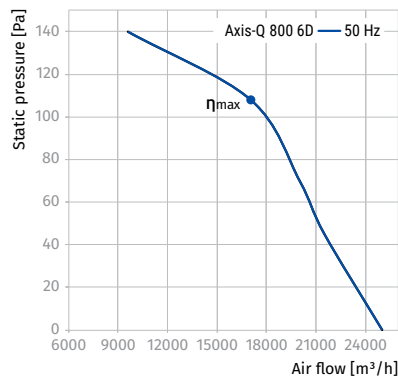

Axis-QR

Axial wall fans

Use

- Supply and extract ventilation systems installed in various premises.
- Ideal solution for boosting large air volumes at low aerodynamic resistance in the ventilation system.
- Refrigerating technologies for cooling of compressor condensing units.
- Direct air extract.
- For positive pressure ventilation in fire-fighting systems.



Air flow:
up to 25000 m³/h
6945 l/s



Power:
from 50 W



Noise level:
from 38 dBA

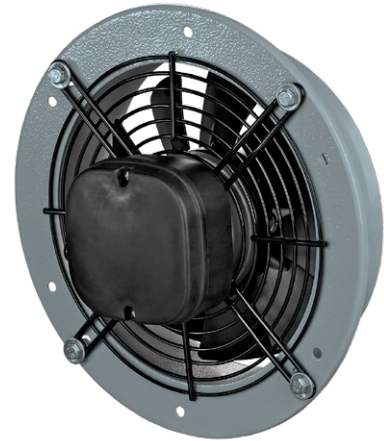

Design

- Steel casing and impeller with a special polymer atmospheric resistant coating.
- Casing is equipped with a round mounting plate and a round flange to facilitate wall mounting.
- The fan is equipped with a terminal box for connection to power mains.

Motor

- Two-, four- or six-pole asynchronous motor with external rotor and axial impeller.
- Single-phase (E) or three-phase (D) motor modifications.
- Equipped with ball bearings for longer service life.
- Integrated overheating protection with automatic restart.

Speed control

- Smooth speed control with an external thyristor controller or step speed control with an external auto transformer (both available upon separate order).

Mounting

- Wall surface mounting with a round connecting frame.
- Any mounting position with respect to air flow direction in the system.
- Power is supplied through an external terminal box.

AXIAL FANS

Designation key

Series	Dimension type	Motor Number of poles	Phase
Axis-QR	200; 250; 300; 350; 400; 450; 500; 550; 630; 710; 800	2; 4; 6	E: single-phase D: three-phase

Accessories

Flexible antivibration connectors	Speed controllers
-----------------------------------	-------------------



EVAF



CDT E1.8

Overall dimensions [mm]

Type	Ø D	Ø D1	Ø D2	Ø d	L	Weight [kg]
Axis-QR 200 2E	210	250	280	7	125	2.8
Axis-QR 250 2E	260	295	340	7	135	3.8
Axis-QR 250 4E	260	295	340	7	135	3.4
Axis-QR 300 2E	317	380	397	9	145	5.9
Axis-QR 300 4E	317	380	397	9	145	5.0
Axis-QR 350 4E	374	442	460	9	165	7.5
Axis-QR 400 4E	417	504	528	9	220	8.5
Axis-QR 450 4E	465	578	607	11	230	10.0
Axis-QR 500 4E	520	590	655	11	250	14.0
Axis-QR 550 4E	570	645	710	11	260	16.5
Axis-QR 630 4E	650	760	800	11	275	20.0
Axis-QR 250 2D	260	295	340	7	135	3.8
Axis-QR 250 4D	260	295	340	7	135	3.4
Axis-QR 300 2D	317	380	397	9	145	5.1
Axis-QR 300 4D	317	380	397	9	145	5.1
Axis-QR 350 4D	374	442	460	9	165	7.5
Axis-QR 400 4D	417	504	528	9	220	8.5
Axis-QR 450 4D	465	578	607	11	230	10.0
Axis-QR 500 4D	520	590	655	11	250	14.0
Axis-QR 550 4D	570	645	710	11	260	16.5
Axis-QR 630 4D	650	760	800	11	275	20.0
Axis-QR 710 6D	725	820	890	13	350	31.0
Axis-QR 800 6D	800	900	970	13	350	42.0

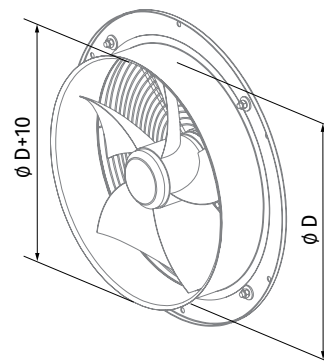
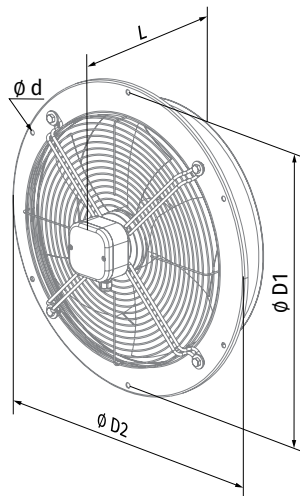

Technical data

Parameters	Axis-QR 200 2E		Axis-QR 250 2E		Axis-QR 250 4E		Axis-QR 300 2E		Axis-QR 300 4E		Axis-QR 350 4E		Axis-QR 400 4E	
Voltage [V]	1 ~ 230		1 ~ 230		1 ~ 230		1 ~ 230		1 ~ 230		1 ~ 230		1 ~ 230	
Frequency [Hz]	50	60	50	60	50	60	50	60	50	60	50	60	50	60
Power [W]	55	61	80	91	50	56	145	178	75	92	140	147	180	240
Current [A]	0.26	0.28	0.4	0.42	0.22	0.24	0.66	0.79	0.35	0.4	0.65	0.66	0.82	1.08
Maximum air flow [m³/h (l/s)]	860 (239)	875 (243)	1050 (292)	1150 (319)	800 (222)	865 (240)	2230 (619)	2280 (633)	1340 (372)	1475 (410)	2500 (695)	2650 (736)	3580 (995)	3890 (1081)
RPM [min ⁻¹]	2300	2550	2400	2990	1380	1730	2300	2410	1350	1405	1380	1700	1380	1655
Sound pressure at 3 m [dBA]	48	49	50	51	38	39	53	54	44	45	46	47	53	54
Transported air temperature [°C]	-30...+60		-30...+50		-30...+60		-30...+50		-30...+60		-30...+50		-30...+60	
IP rating	IPX4		IPX4		IPX4		IPX4		IPX4		IPX4		IPX4	
Motor IP rating	IP44		IP44		IP44		IP44		IP44		IP54		IP54	

AXIS-QR 200 2E

Sound power level, A-weighted	Total	Octave frequency bands [Hz]								LpA 3 m	LpA 1 m
		63	125	250	500	1000	2000	4000	8000		
LWA to environment [dBA]	68	28	39	52	58	66	62	57	50	48	58

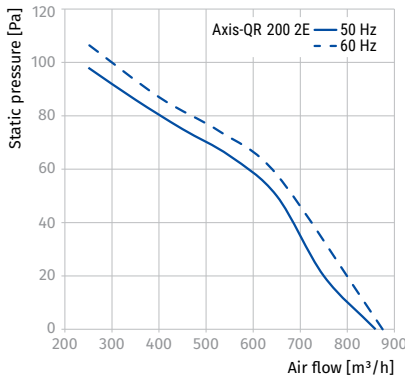

AXIS-QR 250 2E, AXIS-QR 250 4E

Sound power level, A-weighted	Total	Octave frequency bands [Hz]								LpA 3 m	LpA 1 m
		63	125	250	500	1000	2000	4000	8000		
LWA to environment [dBA]	70	29	40	54	60	68	64	59	52	50	60

Axis-QR 250 2E											
LWA to environment [dBA]	70	29	40	54	60	68	64	59	52	50	60

Axis-QR 250 4E											
LWA to environment [dBA]	59	25	39	43	49	54	54	49	43	38	48

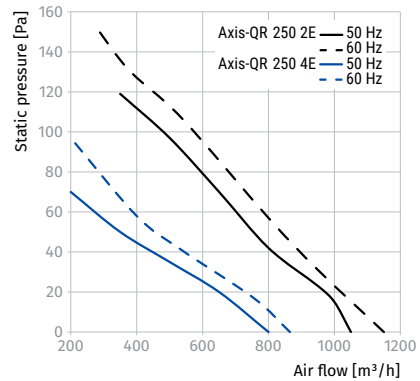

AXIS-QR 300 2E, AXIS-QR 300 4E

Sound power level, A-weighted	Total	Octave frequency bands [Hz]								LpA 3 m	LpA 1 m
		63	125	250	500	1000	2000	4000	8000		
LWA to environment [dBA]	74	40	49	63	63	71	67	60	56	53	63

Axis-QR 300 4E											
LWA to environment [dBA]	64	41	52	47	54	60	60	52	44	44	54

AXIS-QR 300 2E

η [%]	MC	EC	N	VSD	[kW]	[A]	[m³/h]	[Pa]	[RPM]	SR
30.5	A	Static	42.2	No	0.141	0.64	1380	110	2350	1

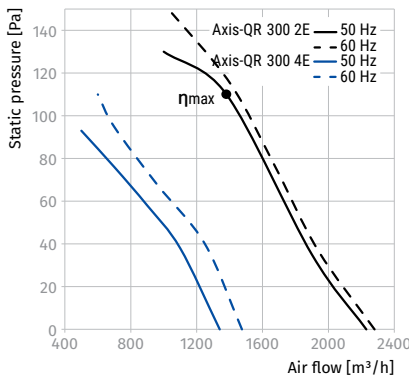

AXIS-QR 350 4E, AXIS-QR 400 4E

Sound power level, A-weighted	Total	Octave frequency bands [Hz]								LpA 3 m	LpA 1 m
		63	125	250	500	1000	2000	4000	8000		
LWA to environment [dBA]	67	26	43	49	60	62	62	53	46	46	56

Axis-QR 400 4E											
LWA to environment [dBA]	73	46	52	58	65	68	68	65	57	53	63

AXIS-QR 350 4E

η [%]	MC	EC	N	VSD	[kW]	[A]	[m³/h]	[Pa]	[RPM]	SR
29.9	A	Static	41.8	No	0.130	0.6	1717	80	1375	1

AXIS-QR 400 4E

η [%]	MC	EC	N	VSD	[kW]	[A]	[m³/h]	[Pa]	[RPM]	SR
33.8	A	Static	44.8	No	0.187	0.86	2787	80	1355	1

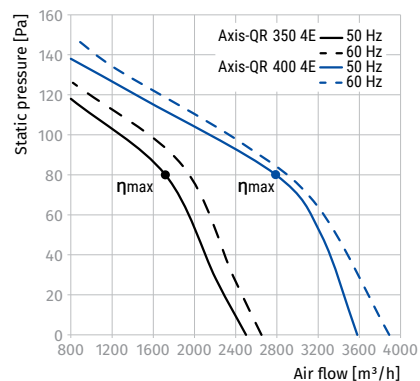

Parameters	Axis-QR 450 4E		Axis-QR 500 4E		Axis-QR 550 4E		Axis-QR 630 4E	
Voltage [V]	1 ~ 230		1 ~ 230		1 ~ 230		1 ~ 230	
Frequency [Hz]	50	60	50	60	50	60	50	60
Power [W]	250	325	420	455	550	654	750	979
Current [A]	1.2	1.46	1.95	2.05	2.55	2.88	3.5	4.26
Maximum air flow [m³/h (l/s)]	4680 (1300)	4790 (1331)	7060 (1961)	7130 (1981)	8800 (2445)	8970 (2492)	11900 (3306)	12100 (3361)
RPM [min⁻¹]	1350	1600	1300	1630	1300	1580	1360	1625
Sound pressure at 3 m [dBA]	56	57	58	59	62	63	67	68
Transported air temperature [°C]	-30...+60		-30...+60		-30...+60		-30...+60	
IP rating	IPX4		IPX4		IPX4		IPX4	
Motor IP rating	IP54		IP54		IP54		IP54	

AXIS-QR 450 4E

Sound power level, A-weighted	Total	Octave frequency bands [Hz]								LpA 3 m	LpA 1 m
		63	125	250	500	1000	2000	4000	8000		
LWA to environment [dBA]	76	46	57	64	70	72	70	66	58	56	66
η [%]	MC	EC	N	VSD	[kW]	[A]	[m³/h]	[Pa]	[RPM]	SR	
32.0	A	Static	41.8	No	0.288	1.31	3610	90	1270	1	

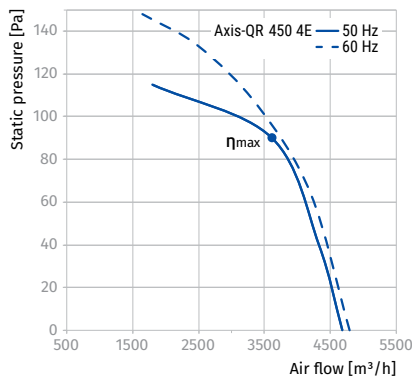

AXIS-QR 500 4E

Sound power level, A-weighted	Total	Octave frequency bands [Hz]								LpA 3 m	LpA 1 m
		63	125	250	500	1000	2000	4000	8000		
LWA to environment [dBA]	79	49	60	67	73	74	73	68	60	58	68
η [%]	MC	EC	N	VSD	[kW]	[A]	[m³/h]	[Pa]	[RPM]	SR	
32.1	A	Static	40.7	No	0.440	2.01	4987	100	1285	1	

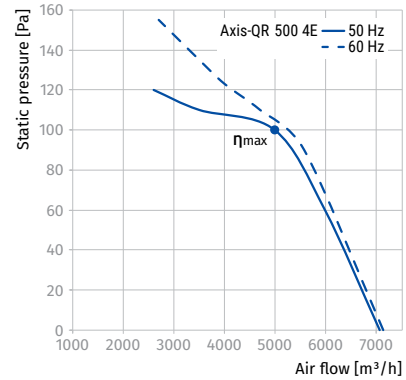

AXIS-QR 550 4E

Sound power level, A-weighted	Total	Octave frequency bands [Hz]								LpA 3 m	LpA 1 m
		63	125	250	500	1000	2000	4000	8000		
LWA to environment [dBA]	83	52	64	71	77	78	77	72	64	62	72
η [%]	MC	EC	N	VSD	[kW]	[A]	[m³/h]	[Pa]	[RPM]	SR	
34.7	A	Static	42.6	No	0.581	2.64	5919	120	1240	1	

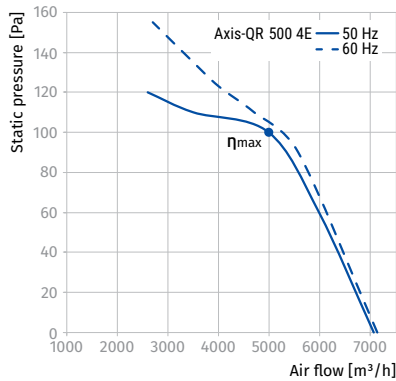

AXIS-QR 630 4E

Sound power level, A-weighted	Total	Octave frequency bands [Hz]								LpA 3 m	LpA 1 m
		63	125	250	500	1000	2000	4000	8000		
LWA to environment [dBA]	88	57	68	76	81	83	82	77	69	67	77
η [%]	MC	EC	N	VSD	[kW]	[A]	[m³/h]	[Pa]	[RPM]	SR	
37.5	A	Static	44.4	No	0.800	3.76	7095	149	1290	1	

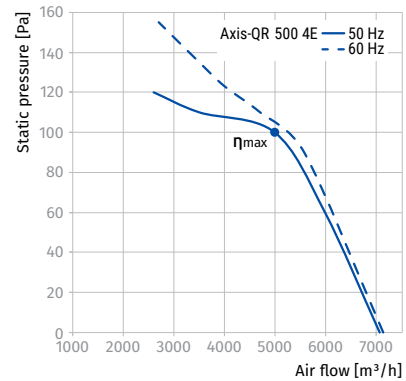

AXIAL FANS

Parameters	Axis-QR 250 2D		Axis-QR 250 4D		Axis-QR 300 2D		Axis-QR 300 4D	
Voltage [V]	3 ~ 400		3 ~ 400		3 ~ 400		3 ~ 400	
Frequency [Hz]	50	60	50	60	50	60	50	60
Power [W]	80	92	60	89	145	165	75	94
Current [A]	0.22	0.24	0.17	0.22	0.25	0.29	0.22	0.25
Maximum air flow [m ³ /h (l/s)]	1060 (294)	1150 (319)	850 (236)	885 (246)	2310 (642)	2390 (664)	1310 (364)	1530 (425)
RPM [min ⁻¹]	2600	3030	1400	1750	2350	2570	1380	1640
Sound pressure at 3 m [dBA]	51	52	38	38	52	52	45	45
Transported air temperature [°C]	-30...+60	-30...+50	-30...+60	-30...+50	-30...+60	-30...+50	-30...+60	-30...+50
IP rating	IPX4		IPX4		IPX4		IPX4	
Motor IP rating	IP44		IP44		IP44		IP44	

AXIS-QR 250 2D, AXIS-QR 250 4D

Sound power level, A-weighted	Total	Octave frequency bands [Hz]								LpA 3 m	LpA 1 m
		63	125	250	500	1000	2000	4000	8000		
Axis-QR 250 2D											
LWA to environment [dBA]	71	29	41	55	61	69	65	60	52	51	61
Axis-QR 250 4D											
LWA to environment [dBA]	59	25	39	43	49	54	54	49	43	38	48

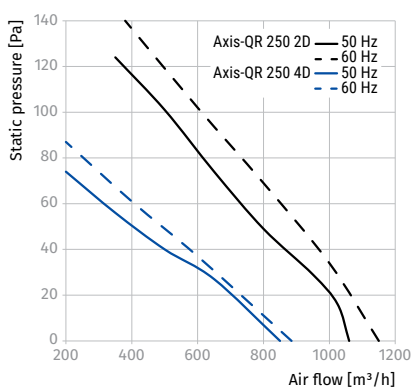
AXIS-QR 300 2D, AXIS-QR 300 4D

Sound power level, A-weighted	Total	Octave frequency bands [Hz]								LpA 3 m	LpA 1 m
		63	125	250	500	1000	2000	4000	8000		
Axis-QR 300 2D											
LWA to environment [dBA]	73	39	48	62	62	70	66	60	55	52	62
Axis-QR 300 4D											
LWA to environment [dBA]	65	42	53	46	55	61	61	53	44	45	55

AXIS-QR 300 2D

η [%]	MC	EC	N	VSD	[kW]	[A]	[m ³ /h]	[Pa]	[RPM]	SR
30.3	A	Static	42	No	0.141	0.25	1367	110	2350	1

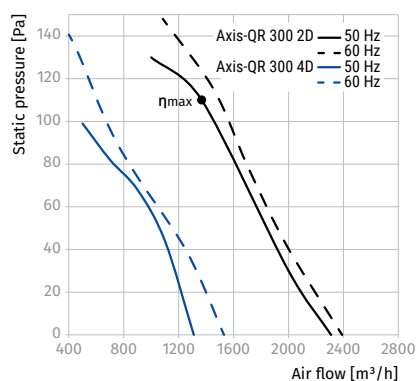

Parameters	Axis-QR 350 4D		Axis-QR 400 4D		Axis-QR 450 4D	
Voltage [V]	3 ~ 400		3 ~ 400		3 ~ 400	
Frequency [Hz]	50	60	50	60	50	60
Power [W]	140	150	180	195	250	275
Current [A]	0.38	0.46	0.47	0.55	0.6	0.65
Maximum air flow [m³/h (l/s)]	2350 (653)	2660 (739)	3740 (1039)	3870 (1075)	5280 (1467)	5350 (1486)
RPM [min⁻¹]	1419	1638	1380	1625	1360	1620
Sound pressure at 3 m [dBA]	46	46	54	54	56	56
Transported air temperature [°C]	-30...+60	-30...+50	-30...+60	-30...+50	-30...+60	-30...+50
IP rating	IPX4		IPX4		IPX4	
Motor IP rating	IP54		IP54		IP54	

AXIS-QR 350 4D, AXIS-QR 400 4D

Sound power level, A-weighted	Total	Octave frequency bands [Hz]								LpA 3 m	LpA 1 m
		63	125	250	500	1000	2000	4000	8000		
Axis-QR 350 4D											
LWA to environment [dBA]	66	26	43	48	59	62	62	53	46	46	56
Axis-QR 400 4D											
LWA to environment [dBA]	74	31	48	58	63	70	70	66	58	54	64

AXIS-QR 350 4D

η [%]	MC	EC	N	VSD	[kW]	[A]	[m³/h]	[Pa]	[RPM]	SR
31.7	A	Static	43.7	No	0.129	0.37	1802	80	1400	1

AXIS-QR 400 4D

η [%]	MC	EC	N	VSD	[kW]	[A]	[m³/h]	[Pa]	[RPM]	SR
34.3	A	Static	44.9	No	0.209	0.47	2807	90	1365	1

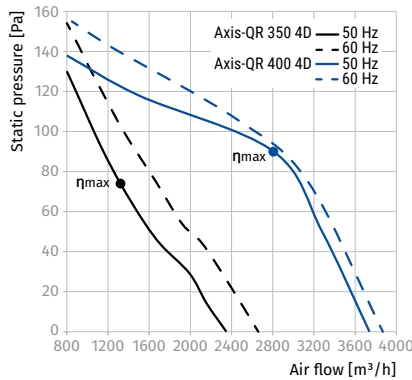

AXIS-QR 450 4D

Sound power level, A-weighted	Total	Octave frequency bands [Hz]								LpA 3 m	LpA 1 m
		63	125	250	500	1000	2000	4000	8000		
LWA to environment [dBA]	77	48	60	67	70	71	72	67	59	56	66
η [%]	MC	EC	N	VSD	[kW]	[A]	[m³/h]	[Pa]	[RPM]	SR	
35.1	A	Static	44.8	No	0.296	0.59	3659	100	1310	1	

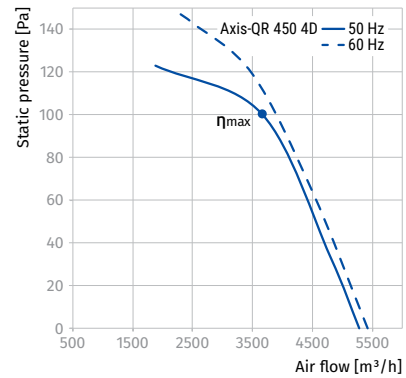

Parameters	Axis-QR 500 4D		Axis-QR 550 4D		Axis-QR 630 4D		Axis-QR 710 6D
Voltage [V]	3 ~ 400		3 ~ 400		3 ~ 400		3 ~ 400
Frequency [Hz]	50	60	50	60	50	60	50
Power [W]	450	370	750	600	800	910	1150
Current [A]	0.9	0.7	1.5	1.1	1.6	1.68	2.0
Maximum air flow [m³/h (l/s)]	6570 (1825)	6230 (1731)	9700 (2695)	7380 (2050)	12200 (3389)	12400 (3445)	15440 (4289)
RPM [min⁻¹]	1300	1605	1350	1605	1320	1585	830
Sound pressure at 3 m [dBA]	60		64		69		63
Transported air temperature [°C]	-30...+60		-30...+60		-30...+60		-30...+60
IP rating	IPX4		IPX4		IPX4		IPX4
Motor IP rating	IP54		IP54		IP54		IP54

AXIS-QR 500 4D

Sound power level, A-weighted	Total	Octave frequency bands [Hz]								LpA 3 m	LpA 1 m
		63	125	250	500	1000	2000	4000	8000		
L _{WA} to environment [dBA]	81	51	63	70	74	75	76	71	62	60	70
η [%]	MC	EC	N	VSD	[kW]	[A]	[m³/h]	[Pa]	[RPM]	SR	
35.5	A	Static	43.9	No	0.478	0.9	4988	120	1305	1	

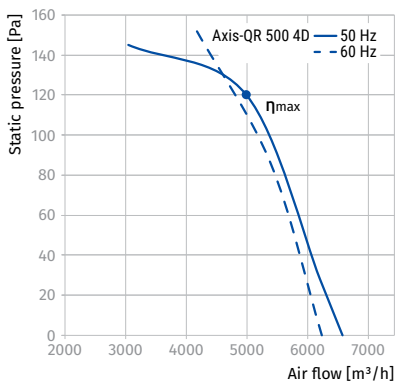

AXIS-QR 550 4D

Sound power level, A-weighted	Total	Octave frequency bands [Hz]								LpA 3 m	LpA 1 m
		63	125	250	500	1000	2000	4000	8000		
L _{WA} to environment [dBA]	85	53	65	72	79	80	79	73	65	64	74
η [%]	MC	EC	N	VSD	[kW]	[A]	[m³/h]	[Pa]	[RPM]	SR	
38.8	A	Static	46.3	No	0.656	1.27	6400	140	1175	1	

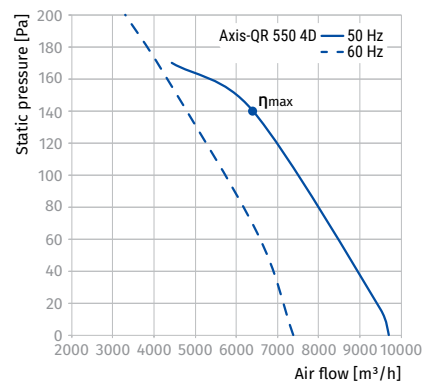

AXIS-QR 630 4D

Sound power level, A-weighted	Total	Octave frequency bands [Hz]								LpA 3 m	LpA 1 m
		63	125	250	500	1000	2000	4000	8000		
L _{WA} to environment [dBA]	90	58	69	78	83	85	84	79	70	69	79
η [%]	MC	EC	N	VSD	[kW]	[A]	[m³/h]	[Pa]	[RPM]	SR	
41.2	A	Static	48.1	No	0.810	1.61	7743	152	1290	1	

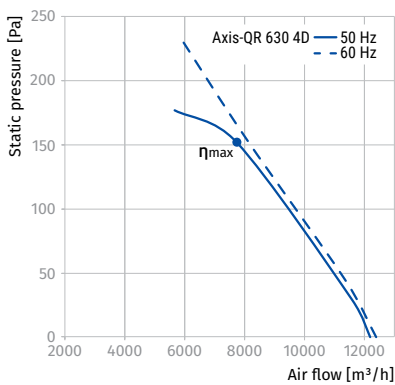

AXIS-QR 710 6D

Sound power level, A-weighted	Total	Octave frequency bands [Hz]								LpA 3 m	LpA 1 m
		63	125	250	500	1000	2000	4000	8000		
L _{WA} to environment [dBA]	83	54	65	72	78	79	77	70	62	63	73
η [%]	MC	EC	N	VSD	[kW]	[A]	[m³/h]	[Pa]	[RPM]	SR	
35.6	A	Static	42	No	0.979	1.91	8777	140	830	1	

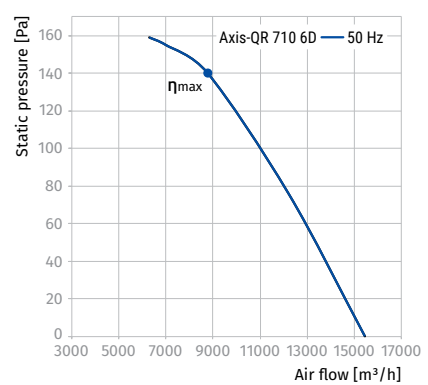

Parameters	Axis-QR 800 6D
Voltage [V]	3 ~ 400
Frequency [Hz]	50
Power [W]	1850
Current [A]	3.7
Maximum air flow [m³/h (l/s)]	25000 (6945)
RPM [min ⁻¹]	915
Sound pressure at 3 m [dBA]	67
Transported air temperature [°C]	-30...+60
IP rating	IPX4
Motor IP rating	IP54

AXIS-QR 800 6D

Sound power level, A-weighted	Total	Octave frequency bands [Hz]								LpA 3 m	LpA 1 m
		63	125	250	500	1000	2000	4000	8000		
L _{WA} to environment [dBA]	88	57	69	77	82	83	81	74	65	67	77

η [%]	MC	EC	N	VSD	[kW]	[A]	[m³/h]	[Pa]	[RPM]	SR
31.6	A	Static	36.6	No	1.650	3.6	17040	108	915	1

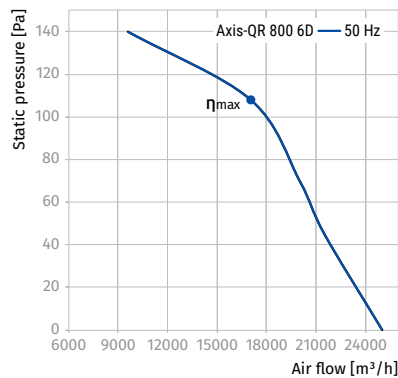

Axis-QA

Axial wall fans

Use

- Supply and extract ventilation systems installed in various premises.
- Mounting in ventilation systems with low static pressure requiring high air capacity.
- Direct air extract.



Air flow:
up to 1700 m³/h
472 l/s



Power:
from 26 W



Noise level:
from 31 dBA



Design

- Compact steel casing covered with special polymer coating.
- Aluminium impeller.
- The casing is equipped with a square mounting plate and flange for easy surface wall mounting.
- The fan is equipped with a power cord and external terminal box for connection to power mains.

Motor

- Single-phase asynchronous motor with an internal rotor and an axial impeller.
- Motor with slide bearings.
- Integrated overheating protection with automatic restart.

Speed control

- Smooth speed control with an external thyristor controller or step speed control with an external auto transformer (both available upon separate order).

Mounting

- Wall surface mounting with a square connecting frame.
- Horizontal installation with respect to air flow direction in the system.
- Power supply through an external terminal box with electric lead-in.

AXIAL FANS

Designation key

Series	Dimension type
Axis-QA	150: branch pipe Ø 162 mm 200: branch pipe Ø 208 mm 250: branch pipe Ø 262 mm 315: branch pipe Ø 312/315 mm

Overall dimensions [mm]

Type	Ø D	Ø d	B	B1	L	Weight [kg]
Axis-QA 150	162	7	250	210	120	2.10
Axis-QA 200	208	7	312	260	120	2.82
Axis-QA 250	262	7	370	320	140	4.88
Axis-QA 315	312	9	430	380	170	5.46

Accessories

Speed controllers



CDT E1.8

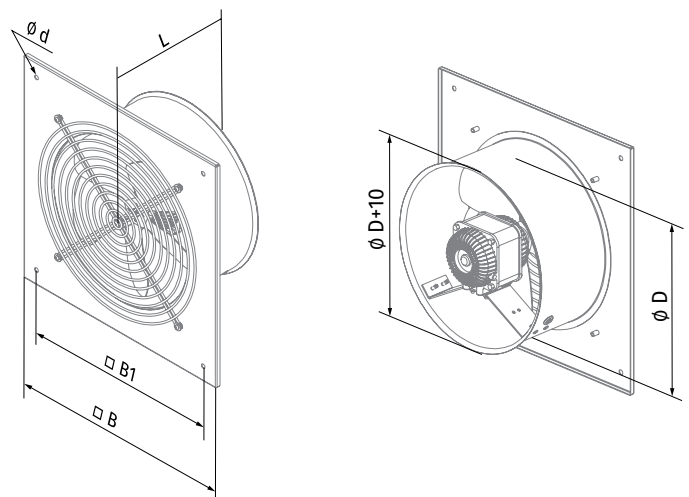

Technical data

Parameters	Axis-QA 150		Axis-QA 200		Axis-QA 250		Axis-QA 315	
Voltage [V]	1~ 220-240		1~ 220-240		1~ 220-240		1~ 220-240	
Frequency [Hz]	50	60	50	60	50	60	50	60
Power [W]	36	26	43	33	68	76	110	104
Current [A]	0.26	0.26	0.28	0.21	0.48	0.51	0.75	0.7
Maximum air flow [m³/h (l/s)]	200 (56)	205 (57)	405 (113)	470 (131)	1070 (297)	1050 (292)	1700 (472)	1650 (458)
RPM [min⁻¹]	1300	1590	1300	1615	1300	1450	1300	1365
Sound pressure at 3 m [dBA]	33	33	33	33	37	37	42	43
Max. transported air temperature [°C]	-30 ... +40		-30 ... +40		-30 ... +40		-30 ... +40	
IP rating	IPX4		IPX4		IPX4		IPX4	
Motor IP rating	IP44		IP44		IP44		IP44	

AXIS-QA 150

Sound power level, A-weighted	Total	Octave frequency bands [Hz]								LpA 3 m	LpA 1 m
		63	125	250	500	1000	2000	4000	8000		
LWA to environment [dBA]	54	22	35	39	45	49	49	45	39	33	43

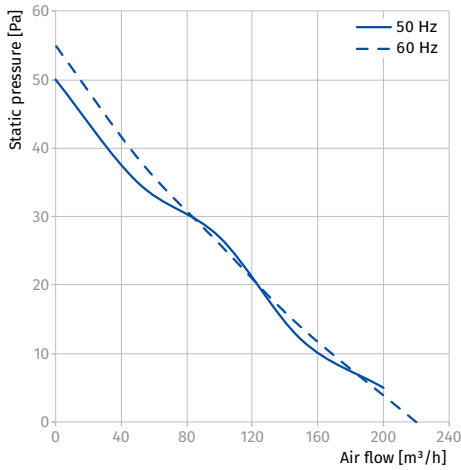

AXIS-QA 200

Sound power level, A-weighted	Total	Octave frequency bands [Hz]								LpA 3 m	LpA 1 m
		63	125	250	500	1000	2000	4000	8000		
LWA to environment [dBA]	53	22	34	38	44	48	48	44	38	32	42

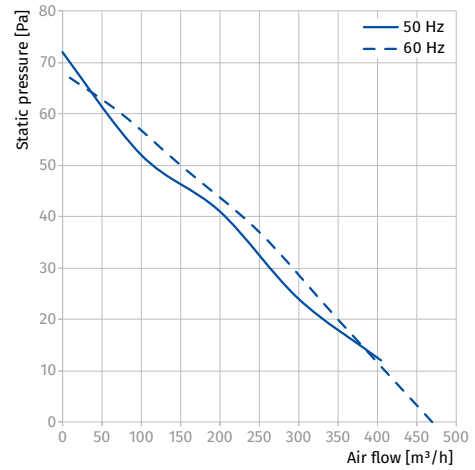

AXIS-QA 250

Sound power level, A-weighted	Total	Octave frequency bands [Hz]								LpA 3 m	LpA 1 m
		63	125	250	500	1000	2000	4000	8000		
LWA to environment [dBA]	58	24	38	42	48	53	53	48	42	37	47

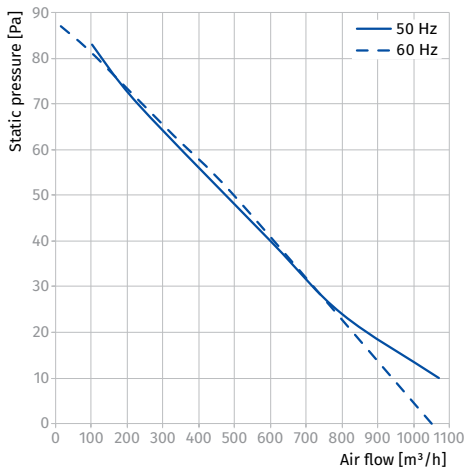

AXIS-QA 315

Sound power level, A-weighted	Total	Octave frequency bands [Hz]								LpA 3 m	LpA 1 m
		63	125	250	500	1000	2000	4000	8000		
LWA to environment [dBA]	62	39	49	44	50	56	49	42	60	42	52

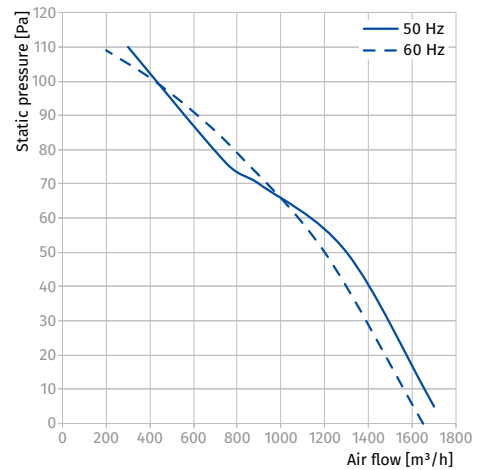

Axis-QRA

Axial wall fans

Use

- Supply and extract ventilation systems installed in various premises.
- Mounting in ventilation systems with low static pressure requiring high air capacity.
- Direct air extract.



Air flow:
up to 1700 m³/h
472 l/s



Power:
from 26 W



Noise level:
from 31 dBA



Design

- Compact steel casing covered with special polymer coating.
- Aluminium impeller.
- The casing is equipped with a round mounting plate and flange for easy surface wall mounting.
- The fan is equipped with a power cord and external terminal box for connection to power mains.

Motor

- Single-phase asynchronous motor with an internal rotor and an axial impeller.
- Motor with slide bearings.
- Integrated overheating protection with automatic restart.

Speed control

- Smooth speed control with an external thyristor controller or step speed control with an external auto transformer (both available upon separate order).

Mounting

- Wall surface mounting with a round connecting frame.
- Horizontal installation with respect to air flow direction in the system.
- Power supply through an external terminal box with electric lead-in.

Designation key

Series	Dimension type
Axis-QRA	150: branch pipe Ø 162 mm
	200: branch pipe Ø 208 mm
	250: branch pipe Ø 262 mm
	315: branch pipe Ø 312/315 mm

Overall dimensions [mm]

Type	Ø D	Ø D1	Ø D2	Ø d	L	Weight [kg]
Axis-QRA 150	162	190	220	7	120	1.91
Axis-QRA 200	208	270	300	7	120	2.50
Axis-QRA 250	262	330	360	7	140	4.10
Axis-QRA 315	312	390	420	9	170	5.24

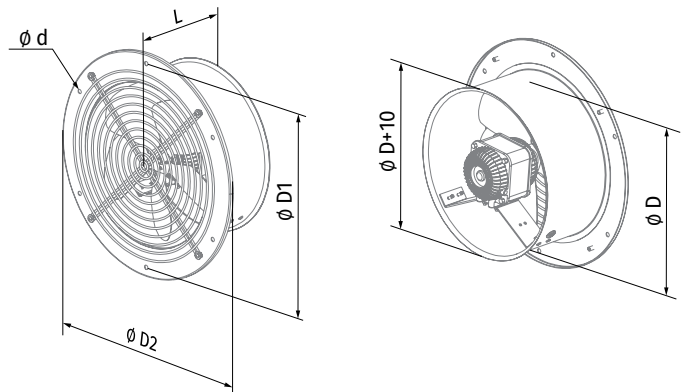

Accessories

Speed controllers



CDT E1.8

Technical data

Parameters	Axis-QRA 150		Axis-QRA 200		Axis-QRA 250		Axis-QRA 315	
Voltage [V]	1~ 220-240		1~ 220-240		1~ 220-240		1~ 220-240	
Frequency [Hz]	50	60	50	60	50	60	50	60
Power [W]	36	26	43	33	68	76	110	104
Current [A]	0.26	0.26	0.28	0.21	0.48	0.51	0.75	0.7
Maximum air flow [m³/h (l/s)]	200 (56)	205 (57)	405 (113)	470 (131)	1070 (297)	1050 (292)	1700 (472)	1650 (458)
RPM [min⁻¹]	1300	1590	1300	1615	1300	1450	1300	1365
Sound pressure at 3 m [dBA]	33	33	33	33	37	37	42	43
Max. transported air temperature [°C]	-30 ... +40		-30 ... +40		-30 ... +40		-30 ... +40	
IP rating	IPX4		IPX4		IPX4		IPX4	
Motor IP rating	IP44		IP44		IP44		IP44	

AXIS-QRA 150

Sound power level, A-weighted	Total	Octave frequency bands [Hz]								LpA 3 m	LpA 1 m
		63	125	250	500	1000	2000	4000	8000		
LWA to environment [dBA]	54	22	35	39	45	49	49	45	39	33	43

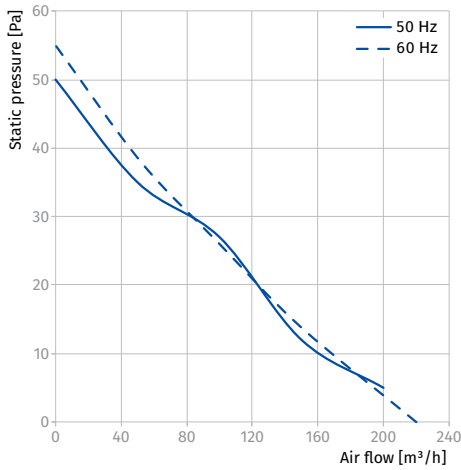

AXIS-QRA 200

Sound power level, A-weighted	Total	Octave frequency bands [Hz]								LpA 3 m	LpA 1 m
		63	125	250	500	1000	2000	4000	8000		
LWA to environment [dBA]	53	22	34	38	44	48	48	44	38	32	42

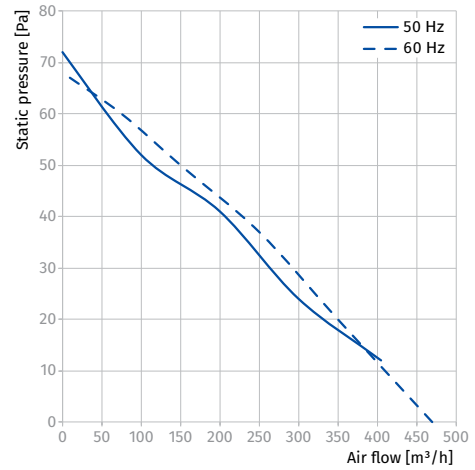

AXIS-QRA 250

Sound power level, A-weighted	Total	Octave frequency bands [Hz]								LpA 3 m	LpA 1 m
		63	125	250	500	1000	2000	4000	8000		
LWA to environment [dBA]	58	24	38	42	48	53	53	48	42	37	47

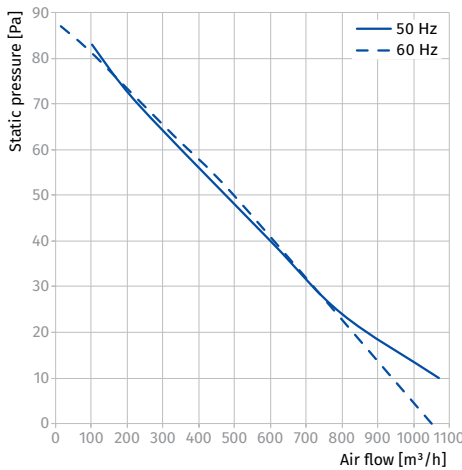

AXIS-QRA 315

Sound power level, A-weighted	Total	Octave frequency bands [Hz]								LpA 3 m	LpA 1 m
		63	125	250	500	1000	2000	4000	8000		
LWA to environment [dBA]	62	39	49	44	50	56	49	42	60	42	52

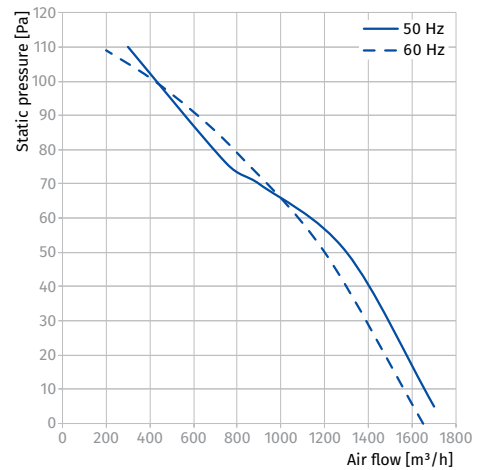

Tower-V

Roof centrifugal fans

Use

- Extract ventilation systems installed in various premises.
- Roof mounting.
- For any types of roofs or vertical ventilation shafts.



Air flow:
up to 17 010 m³/h
4725 l/s



Power:
from 48 W



Noise level:
from 45 dBA

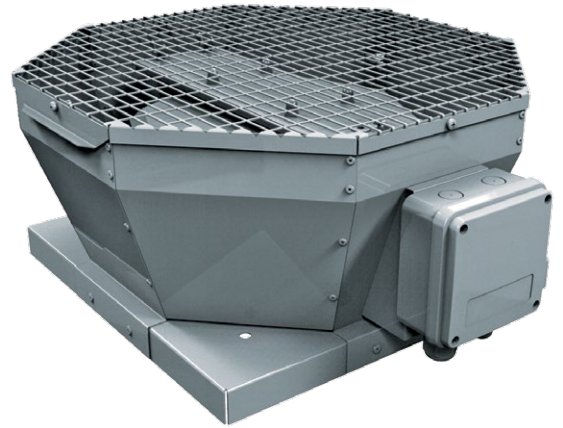

Design

- Steel casing with a special polymer atmospheric resistant coating.
- Vertical air exhaust.
- The fan is equipped with a terminal block for connection to power mains.
- The fan is rated for continuous operation.
- The upper cover is equipped with two eye bolts for easy fan lifting on the roof with hoisting mechanism.
- A connecting plate with an intake opening is designed to facilitate mounting to the roof surface.

Motor

- Two-, four- or six-pole asynchronous motor with external rotor and centrifugal impeller with backward curved blades.
- Single-phase (E) or three-phase (D) motor modifications.
- Dynamically balanced impeller.
- Equipped with ball bearings for longer service life.
- Overheating protection with built-in thermal switches with automatic restart or with leaded outside terminals for connection to external protecting controls.
- The thermal switch terminal leads are designed for connection to respective circuit of the overload relay or respective terminals of the auto-transformer or thyristor speed controller.

Speed control

- Smooth speed control with an external thyristor controller or step speed control with an external auto transformer (both available upon separate order).

Mounting

- Roof mounting directly above a ventilation shaft or air duct.
- The fan is connected to the air duct with the intake flange that is fixed to the fan base.
- The fan base has holes for fixing bolts that attach the fan to a stable level surface or a roof frame.
- Roof frame and intake flange available on separate order.
- Power is supplied through an external terminal box.

Designation key

Series	Impeller standard size	Motor Number of poles	Phase	Casing material
Tower-V	190; 220; 225; 250; 280; 310; 355; 400; 450; 500; 560; 630; 710	2; 4; 6	E: single-phase D: three-phase	_: steel with polymeric coating A: aluminum

Accessories

Flexible connectors for roof fans	Counterflanges	Mounting frames	Silencers	Backdraft air dampers	Air dampers	Speed controllers
 VDL	 FDL	 MRDL / MRIDL	 SD	 VRV	 VK / VKA	 CDT E1.8

Overall dimensions [mm]

Type	∅D	H	L	L1	Weight [kg]
Tower-V 190 2E	213	170	417	355	7
Tower-V 220 2E*	213	190	417	355	7
Tower-V 225 2E*	210	215	417	355	7
Tower-V 225 4E*	210	215	417	355	7
Tower-V 250 2E	285	240	481	425	9
Tower-V 250 4E	285	240	481	425	9
Tower-V 280 4E	291	276	547	425	13
Tower-V 310 2E	285	276	547	425	13
Tower-V 310 4E*	285	300	613	477	20
Tower-V 310 4D*	285	300	613	477	19
Tower-V 355 4E	438	300	738	598	26
Tower-V 355 4D	438	300	738	598	26
Tower-V 400 4E	438	375	738	598	33
Tower-V 400 6E	438	375	738	598	31
Tower-V 400 4D	438	375	738	598	33
Tower-V 450 4E	438	430	738	668	41
Tower-V 450 6E	438	430	738	668	41
Tower-V 450 4D	438	425	738	668	41
Tower-V 500 6E*	445	460	859	668	52
Tower-V 500 4D*	430	460	859	668	52
Tower-V 500 6D*	445	460	859	668	52
Tower-V 560 6E	605	485	859	833	63
Tower-V 560 4D	605	485	859	833	63
Tower-V 560 6D	605	485	859	833	63
Tower-V 630 6D*	600	485	951	939	81
Tower-V 710 6D*	674	485	992	939	114

*The counter flange (not included in the delivery set) should be mounted together with the inlet ring.

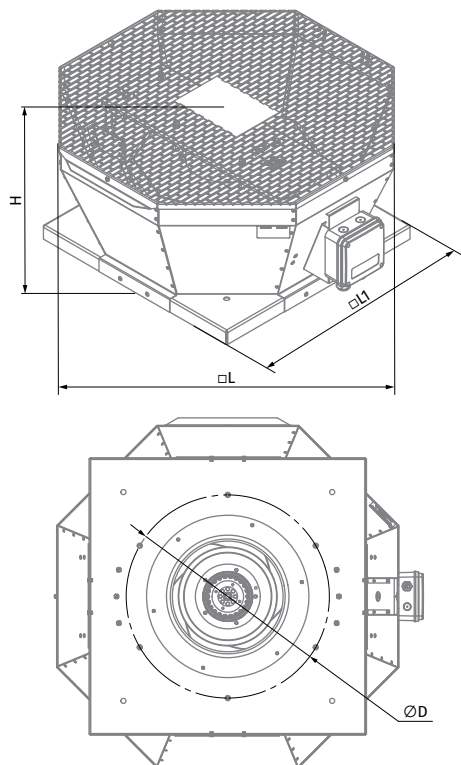

Technical data

Parameters	Tower-V 190 2E		Tower-V 220 2E		Tower-V 225 2E		Tower-V 225 4E	
Voltage [V]	1~230		1~230		1~230		1~230	
Frequency [Hz]	50	60	50	60	50	60	50	
Power [W]	69	89	108	118	123	169	49	
Current [A]	0.30	0.40	0.49	0.54	0.54	0.70	0.22	
Maximum air flow [m³/h (l/s)]	610 (169)	654 (182)	880 (244)	883 (245)	915 (254)	1010 (281)	738 (205)	
RPM [min ⁻¹]	2680	2980	2580	2840	2790	2820	1400	
Sound pressure at 3 m [dBA]	48	49	50	51	51	52	45	
Max. transported air temperature [°C]	-25...+50		-25...+50		-25...+50		-25...+50	
SEC class	C	-	C	-	C	-	C	
IP rating	IPX4		IPX4		IPX4		IPX4	
Motor IP rating	IP44		IP44		IP44		IP44	
ErP	2018	-	2018	-	2018	-	2018	

TOWER-V 190 2E

Sound power level, A-weighted	Total	Octave frequency bands [Hz]								LpA 3 m	LpA 1 m
		63	125	250	500	1000	2000	4000	8000		
LWA to inlet [dBA]	68	39	65	63	54	52	49	49	39	47	57
LWA to environment [dBA]	69	28	50	61	64	63	62	54	41	48	58

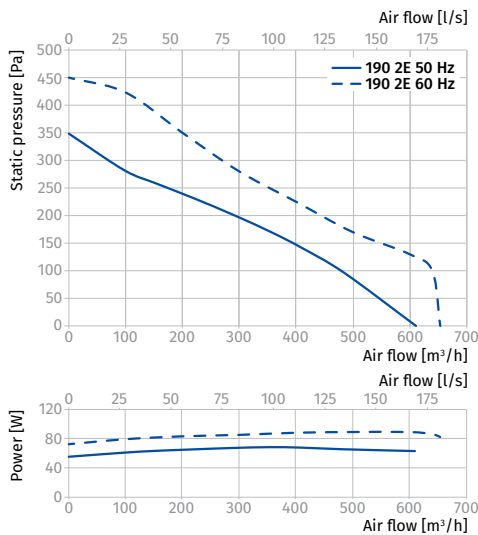
TOWER-V 220 2E

Sound power level, A-weighted	Total	Octave frequency bands [Hz]								LpA 3 m	LpA 1 m
		63	125	250	500	1000	2000	4000	8000		
LWA to inlet [dBA]	70	59	65	65	61	55	55	54	47	49	59
LWA to environment [dBA]	71	46	58	66	65	66	56	51	41	50	60

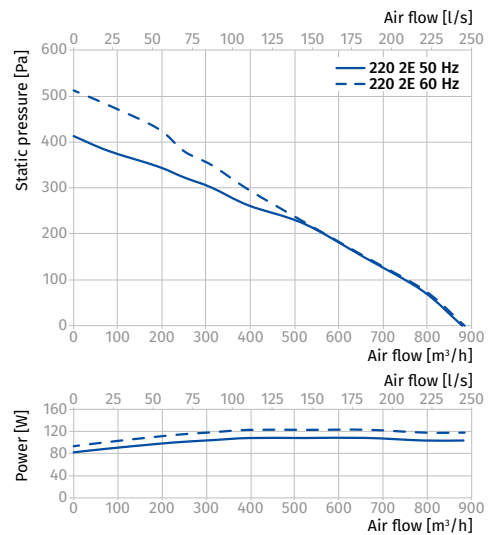
TOWER-V 225 2E

Sound power level, A-weighted	Total	Octave frequency bands [Hz]								LpA 3 m	LpA 1 m
		63	125	250	500	1000	2000	4000	8000		
LWA to inlet [dBA]	71	61	66	66	62	57	57	55	48	51	61
LWA to environment [dBA]	72	47	59	67	66	67	57	52	42	51	61

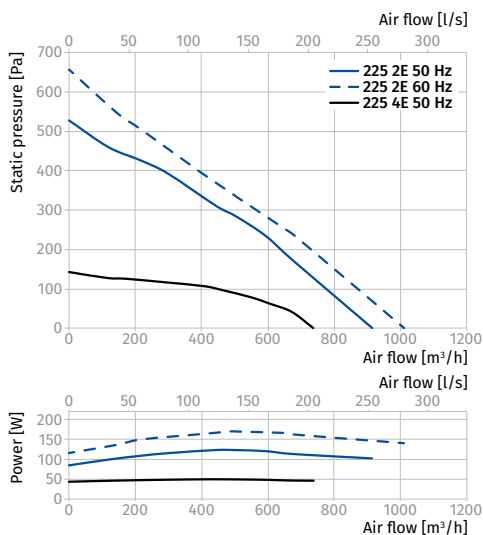

Parameters	Tower-V 250 2E		Tower-V 250 4E	Tower-V 280 4E	
Voltage [V]	1~230		1~230	1~230	
Frequency [Hz]	50	60	50	50	60
Power [W]	184	232	48	125	155
Current [A]	0.81	0.90	0.23	0.61	0.99
Maximum air flow [m³/h (l/s)]	1450 (403)	1320 (367)	820 (228)	1490 (414)	1520 (422)
RPM [min⁻¹]	2480	2320	1440	1446	1710
Sound pressure at 3 m [dBA]	54	53	46	46	46
Max. transported air temperature [°C]	-25...+50		-25...+50	-25...+50	
SEC class	-		-	-	
IP rating	IPX4		IPX4	IPX4	
Motor IP rating	IP44		IP44	IP44	
ErP	2018	-	2018	2018	-

TOWER-V 250 2E, TOWER-V 250 4E

Sound power level, A-weighted	Total	Octave frequency bands [Hz]								LpA 3 m	LpA 1 m
		63	125	250	500	1000	2000	4000	8000		
Tower-V 250 2E											
LWA to inlet [dBA]	75	50	63	70	68	69	66	63	53	54	64
LWA to environment [dBA]	75	51	64	71	67	67	66	62	56	54	64
Tower-V 250 4E											
LWA to inlet [dBA]	68	51	57	60	52	63	62	57	52	47	57
LWA to environment [dBA]	67	29	48	57	60	63	59	51	37	46	56

TOWER-V 280 4E

Sound power level, A-weighted	Total	Octave frequency bands [Hz]								LpA 3 m	LpA 1 m
		63	125	250	500	1000	2000	4000	8000		
LWA to inlet [dBA]	66	46	55	53	59	60	59	55	45	45	55
LWA to environment [dBA]	67	29	48	57	60	63	59	51	37	46	56

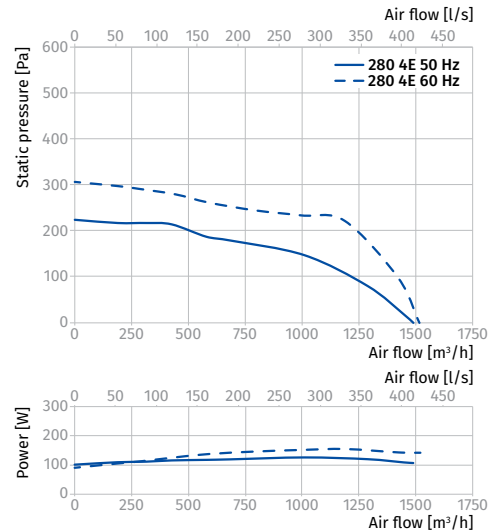
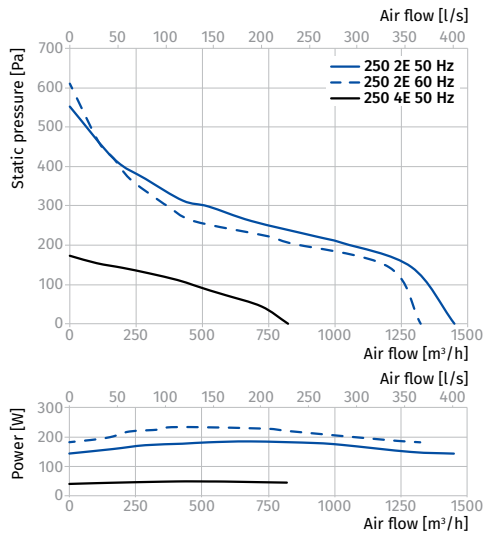

ROOF FANS

Parameters	Tower-V 310 2E	Tower-V 310 4E		Tower-V 310 4D		Tower-V 355 4E		Tower-V 355 4D	
Voltage [V]	1~230	1~230		3~400		1~230		3~400	
Frequency [Hz]	50	50	60	50	60	50	60	50	60
Power [W]	324	141	195	155	202	219	304	264	330
Current [A]	1.42	0.64	0.87	0.29	0.32	0.96	1.33	0.58	0.64
Maximum air flow [m³/h (l/s)]	2150 (597)	2265 (629)	2425 (674)	2300 (639)	2442 (678)	2480 (689)	2976 (827)	3290 (914)	3540 (983)
RPM [min ⁻¹]	2620	1420	1740	1410	1550	1420	1580	1430	1650
Sound pressure at 3 m [dBA]	58	47	49	47	48	51	52	52	53
Max. transported air temperature [°C]	-25...+50	-25...+50		-25...+50		-25...+50		-30...+60	
IP rating	IPX4	IPX4		IPX4		IPX4		IPX4	
Motor IP rating	IP44	IP54		IP54		IP54		IP54	
ErP	2018	2018	-	2018	-	2018	-	2018	-

TOWER-V 310 2E, TOWER-V 310 4E, TOWER-V 310 4D

Sound power level, A-weighted	Total	Octave frequency bands [Hz]								LpA 3 m	LpA 1 m
		63	125	250	500	1000	2000	4000	8000		
Tower-V 310 2E											
LWA to inlet [dBA]	76	47	48	56	69	71	71	69	59	56	66
LWA to environment [dBA]	79	40	48	62	73	74	74	66	49	58	68
Tower-V 310 4E											
LWA to inlet [dBA]	67	47	56	54	61	62	61	57	47	47	57
LWA to environment [dBA]	68	30	49	58	61	65	60	52	38	47	57
Tower-V 310 4D											
LWA to inlet [dBA]	67	46	53	56	62	63	58	55	43	47	57
LWA to environment [dBA]	67	55	59	56	58	63	58	58	39	47	57

TOWER-V 355 4E, TOWER-V 355 4D

Sound power level, A-weighted	Total	Octave frequency bands [Hz]								LpA 3 m	LpA 1 m
		63	125	250	500	1000	2000	4000	8000		
Tower-V 355 4E											
LWA to inlet [dBA]	69	42	43	50	62	64	64	62	53	49	59
LWA to environment [dBA]	72	36	43	56	66	67	67	60	44	51	61
Tower-V 355 4D											
LWA to inlet [dBA]	71	43	44	52	63	66	66	64	54	50	60
LWA to environment [dBA]	73	36	44	57	67	68	68	60	45	52	62

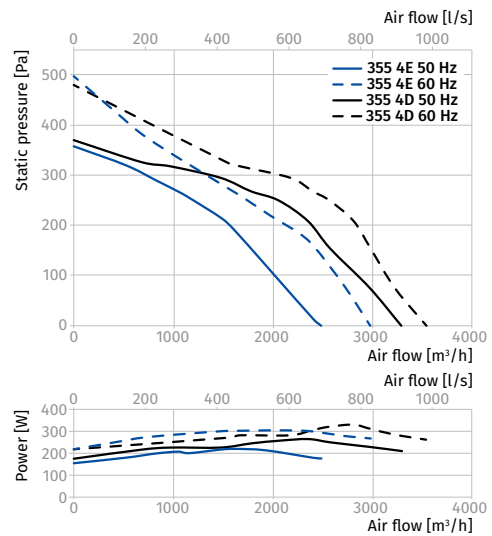
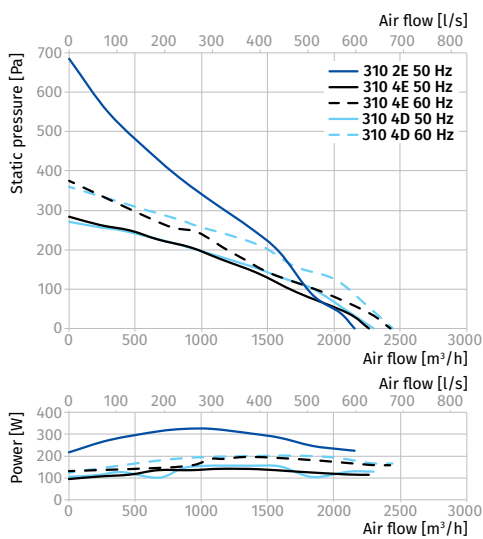

Parameters	Tower-V 400 4E	Tower-V 400 6E		Tower-V 400 4D	Tower-V 450 4E	Tower-V 450 6E	Tower-V 450 4D
Voltage [V]	1~230	1~230		3~400	1~230	1~230	3~400
Frequency [Hz]	50	50	60	50	50	50	50
Power [W]	457	184	249	420	749	268	755
Current [A]	2.00	0.89	1.10	0.99	3.35	1.25	1.50
Maximum air flow [m³/h (l/s)]	3950 (1097)	2740 (761)	3289 (914)	3950 (1097)	6180 (1717)	4380 (1217)	5920 (1644)
RPM [min⁻¹]	1440	945	1071	1440	1400	940	1440
Sound pressure at 3 m [dBA]	55	47	49	55	58	50	57
Max. transported air temperature [°C]	-30...+60	-30...+60		-30...+60	-30...+60	-30...+60	-30...+50
IP rating	IPX4	IPX4		IPX4	IPX4	IPX4	IPX4
Motor IP rating	IP54	IP54		IP54	IP54	IP54	IP54
ErP	2018	2018	-	2018	2018	2018	2018

TOWER-V 400 4E, TOWER-V 400 4D, TOWER-V 400 6E

Sound power level, A-weighted	Total	Octave frequency bands [Hz]								LpA 3 m	LpA 1 m
		63	125	250	500	1000	2000	4000	8000		
Tower-V 400 4E											
LWA to inlet [dBA]	75	46	47	55	67	70	70	68	57	54	64
LWA to environment [dBA]	76	38	46	59	70	71	71	63	47	55	65
Tower-V 400 4D											
LWA to inlet [dBA]	75	44	73	70	60	58	55	54	43	54	64
LWA to environment [dBA]	76	30	56	68	71	70	69	60	46	55	65
Tower-V 400 6E											
LWA to inlet [dBA]	65	44	51	54	60	61	56	52	41	45	55
LWA to environment [dBA]	67	55	59	56	58	63	58	58	39	47	57

TOWER-V 450 4E, TOWER-V 450 4D, TOWER-V 450 6E

Sound power level, A-weighted	Total	Octave frequency bands [Hz]								LpA 3 m	LpA 1 m
		63	125	250	500	1000	2000	4000	8000		
Tower-V 450 4E											
LWA to inlet [dBA]	78	45	75	73	62	60	57	56	45	57	67
LWA to environment [dBA]	78	31	58	70	74	73	71	62	47	58	68
Tower-V 450 4D											
LWA to inlet [dBA]	77	45	74	72	61	60	56	55	45	56	66
LWA to environment [dBA]	77	31	57	69	73	71	70	61	46	57	67
Tower-V 450 6E											
LWA to inlet [dBA]	68	46	54	57	63	64	59	55	43	48	58
LWA to environment [dBA]	70	58	62	59	61	66	60	61	41	50	60

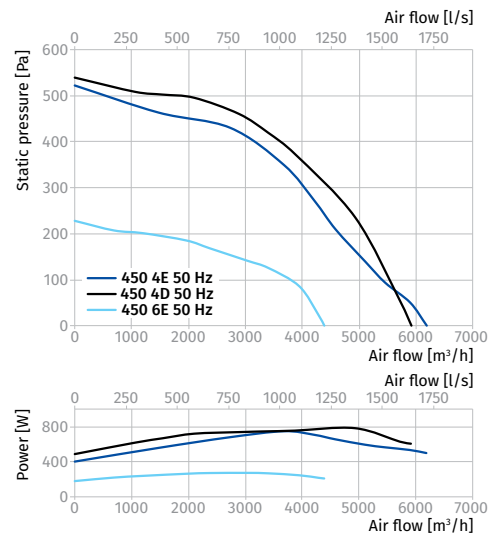
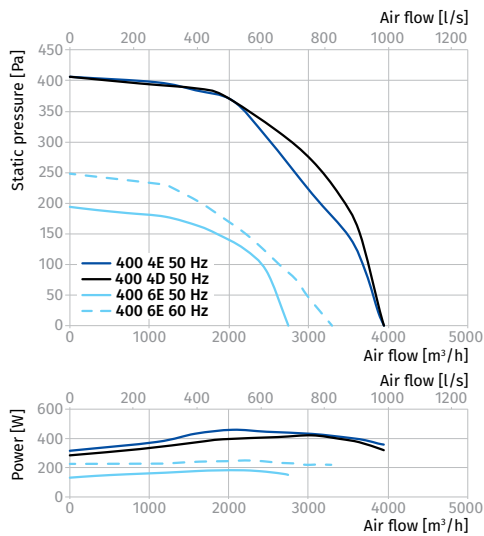

ROOF FANS

Parameters	Tower-V 500 4D	Tower-V 500 6E		Tower-V 500 6D		Tower-V 560 4D	Tower-V 560 6E	Tower-V 560 6D
Voltage [V]	3~400	1~230		3~400		3~400	1~230	3~400
Frequency [Hz]	50	50	60	50	60	50	50	50
Power [W]	1527	407	673	440	599	1970	613	696
Current [A]	2.64	1.81	3.05	1.23	1.32	3.36	2.70	1.44
Maximum air flow [m³/h (l/s)]	8435 (2343)	5680 (1578)	6532 (1814)	6000 (1667)	6122 (1701)	13 560 (3767)	9560 (2656)	9630 (2675)
RPM [min ⁻¹]	1460	970	1120	978	1125	1400	930	970
Sound pressure at 3 m [dBA]	62	52	54	52	54	66	58	58
Max. transported air temperature [°C]	-30...+50	-25...+60		-25...+60		-25...+50	-25...+50	-25...+50
IP rating	IPX4	IPX4		IPX4		IPX4	IPX4	IPX4
Motor IP rating	IP54	IP54		IP54		IP54	IP54	IP54
ErP	2018	2018	-	2018	-	2018	2018	2018

TOWER-V 500 4D, TOWER-V 500 6E, TOWER-V 500 6D

Sound power level, A-weighted	Total	Octave frequency bands [Hz]							LpA 3 m	LpA 1 m	
		63	125	250	500	1000	2000	4000			8000
Tower-V 500 4D											
LWA to inlet [dBA]	82	48	80	77	65	64	60	59	48	61	71
LWA to environment [dBA]	83	33	61	74	78	77	76	65	50	62	72
Tower-V 500 6E											
LWA to inlet [dBA]	70	48	56	59	66	66	61	57	45	50	60
LWA to environment [dBA]	72	60	64	60	63	68	62	63	42	52	62
Tower-V 500 6D											
LWA to inlet [dBA]	70	48	55	58	65	66	61	57	44	49	59
LWA to environment [dBA]	72	60	64	60	63	68	62	63	42	52	62

TOWER-V 560 4D, TOWER-V 560 6E, TOWER-V 560 6D

Sound power level, A-weighted	Total	Octave frequency bands [Hz]							LpA 3 m	LpA 1 m	
		63	125	250	500	1000	2000	4000			8000
Tower-V 560 4D											
LWA to inlet [dBA]	85	50	83	80	68	66	62	61	49	64	74
LWA to environment [dBA]	87	35	65	78	82	81	80	69	53	66	76
Tower-V 560 6E											
LWA to inlet [dBA]	77	64	69	71	70	67	67	66	59	56	66
LWA to environment [dBA]	79	52	65	74	73	74	63	57	46	58	68
Tower-V 560 6D											
LWA to inlet [dBA]	77	65	70	71	71	68	68	67	59	57	67
LWA to environment [dBA]	79	52	65	74	73	74	63	57	46	58	68

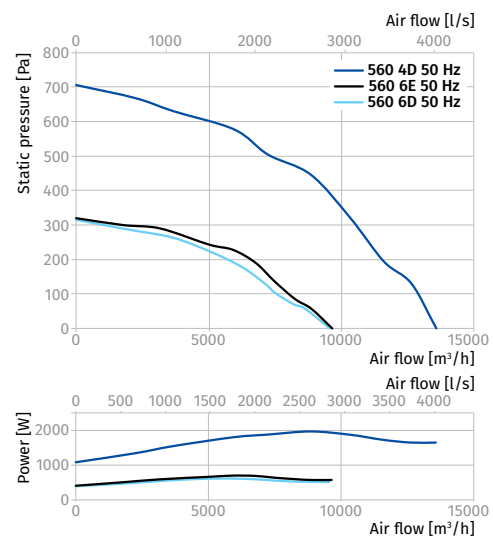
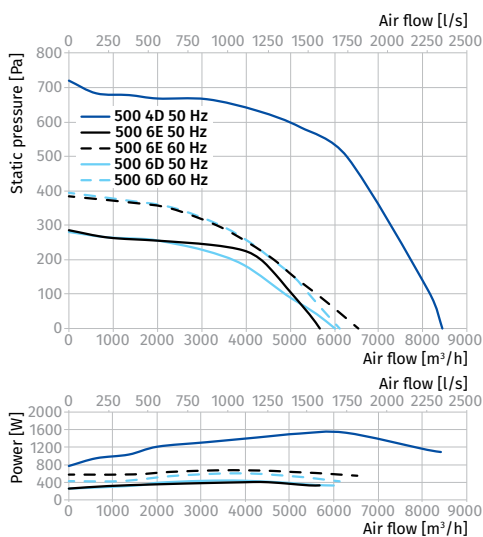

Parameters	Tower-V 630 6D	Tower-V 710 6D
Voltage [V]	3~400	3~400
Frequency [Hz]	50	50
Power [W]	1110	2583
Current [A]	2.42	4.87
Maximum air flow [m³/h (l/s)]	12 640 (3511)	17 010 (4725)
RPM [min ⁻¹]	957	945
Sound pressure at 3 m [dBA]	64	67
Max. transported air temperature [°C]	-25...+50	-25...+70
IP rating	IPX4	IPX4
Motor IP rating	IP54	IP54
ErP	2018	2018

TOWER-V 630 6D

Sound power level, A-weighted	Total	Octave frequency bands [Hz]								LpA 3 m	LpA 1 m
		63	125	250	500	1000	2000	4000	8000		
LWA to inlet [dBA]	82	69	74	76	75	72	72	71	63	61	71
LWA to environment [dBA]	85	56	70	80	79	80	68	62	50	64	74

TOWER-V 710 6D

Sound power level, A-weighted	Total	Octave frequency bands [Hz]								LpA 3 m	LpA 1 m
		63	125	250	500	1000	2000	4000	8000		
LWA to inlet [dBA]	85	72	78	80	79	76	76	75	66	65	75
LWA to environment [dBA]	88	58	73	83	82	83	71	64	52	67	77

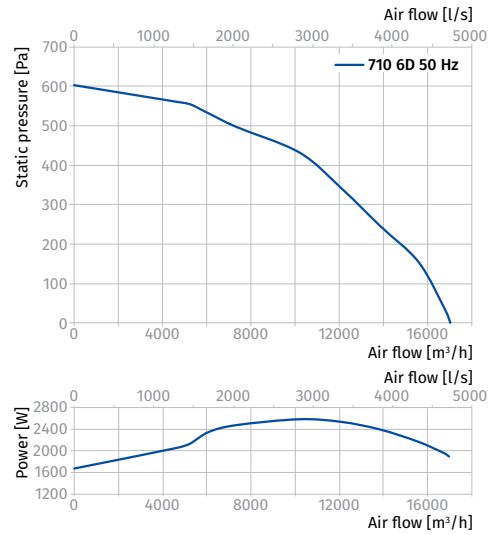
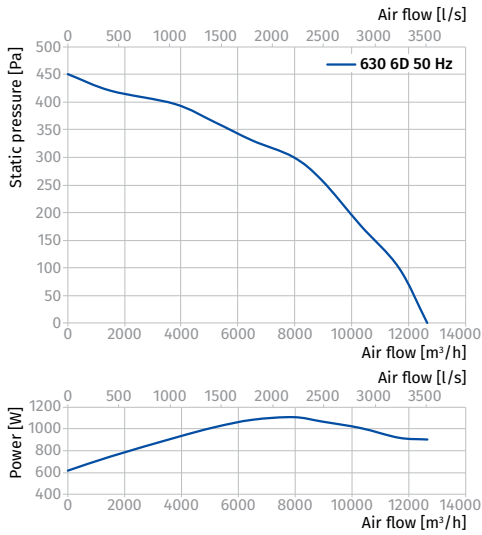

ROOF FANS

Tower-V EC

Roof centrifugal fans with EC motor

Use

- Extract ventilation systems installed in various premises.
- Roof mounting.
- Any roof types or vertical ventilation shafts.
- For arranging energy-saving and controllable ventilation systems.



Air flow:
up to 18270 m³/h
5075 l/s



Power:
from 101 W



Noise level:
from 47 dBA

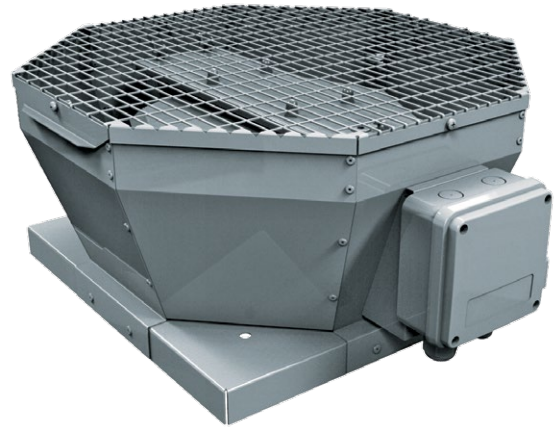

Design

- The casing is made of steel with a polymer atmospheric resistant coating.
- Vertical air exhaust.
- The fan is equipped with a terminal box for connection to power mains.
- The fan is rated for continuous operation always connected to power mains.
- A connecting plate is provided to facilitate mounting to the roof surface or to the mounting frame.

Motor

- High-efficient direct current EC motor with external rotor and backward curved blades.
- EC technology meets the up-to-date requirements to energy-saving and controllable ventilation and provides up to 35 % energy saving as compared to asynchronous motors.
- EC motor ensures totally controllable speed range for the fan and has integrated overheating protection with automatic restart.
- EC motor has no friction and wearing parts as capacitor and brushes. Instead a maintenance-free EC controller electronic circuit board is used.
- The impeller is dynamically balanced.
- The fan is compatible with 50 Hz and 60 Hz power mains and the maximum speed does not depend on power mains frequency.

Operation and speed control

- The fan speed is controlled with a 0–10 V control signal from the following sources:
 - integrated or external speed controller
 - controller with sensors
 - central BMS system.
- The control signal value changes depending on air temperature, pressure, smoke concentration and other parameters.
- During signal value change the fan with EC motor correspondingly changes the rotations speed and delivers required air volume to the ventilation system.
- The computer central building management systems (BMS) enable integration of several EC motors in network and precise individual operation control for each fan.

Mounting

- Roof mounting directly above a ventilation shaft or an air duct.
- The fan is attached to a square air duct or to the **MRDL/MRIDL** mounting frame (see accessories).
- The counterflange **FDL** mounted on the fan bottom (see accessories) is designed for the fan connection to a round air duct.
- The **KDL** backdraft dampers (see Accessories) are designed to prevent air back drafting when the fan is off.
- The **VDL** flexible connectors (see Accessories) are designed to absorb vibration from the fan to the air duct.
- External terminal box for connection to power mains.

Designation key

Series	Motor type	Impeller standard size	Casing material
Tower-V	EC: electronically commutated motor	190; 225; 250; 280; 310; 355; 400; 450; 500; 560; 630	_: steel with polymeric coating A: aluminum

Accessories

Backdraft dampers	Flexible connectors for roof fans	Counterflanges	Mounting frames	Silencers	Backdraft air dampers	Air dampers	Speed controllers
KDL	VDL	FDL	MRDL / MRIDL	SD	VRV	VK / VKA	CDT E/0-10

Overall dimensions [mm]

Type	L	L1	H	L2	Weight [kg]
Tower-V EC 190	417	354	166	53	7
Tower-V EC 225	417	355	210	53	7
Tower-V EC 250	481	425	236	53	11
Tower-V EC 280	547	425	274	53	14
Tower-V EC 310	613	477	296	53	20
Tower-V EC 355	738	598	326	53	23
Tower-V EC 400	738	598	371	53	25
Tower-V EC 450	738	668	425	53	44
Tower-V EC 500	859	668	455	53	52
Tower-V EC 560	859	833	478	53	63
Tower-V EC 630	951	890	530	53	80

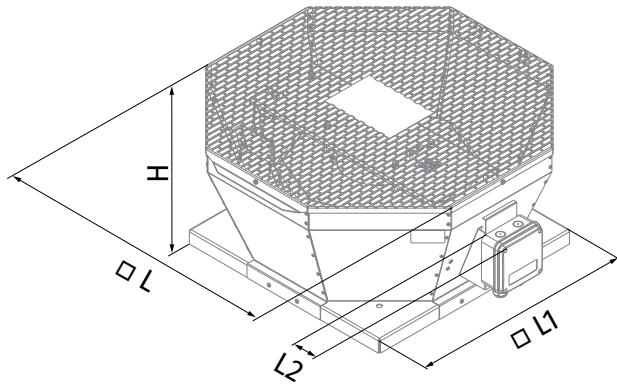

Technical data

Parameters	Tower-V EC 190	Tower-V EC 225
Voltage [V]	1 ~ 230	1 ~ 230
Frequency [Hz]	50/60	50/60
Power [W]	102	101
Current [A]	0.77	0.80
Maximum air flow [m³/h (l/s)]	670 (186)	1290 (358)
RPM [min ⁻¹]	3520	2400
Sound pressure at 3 m [dBA]	52	47
Transported air temperature [°C]	-25...+60	-25...+60
SEC class	B	-
IP rating	IPX4	IPX4
Motor IP rating	IP55	IP55
ErP	2018	2018

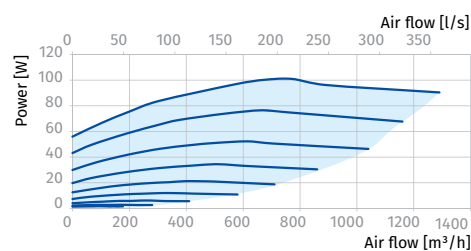
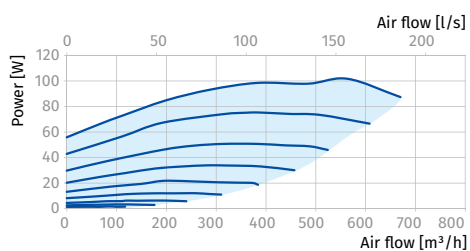
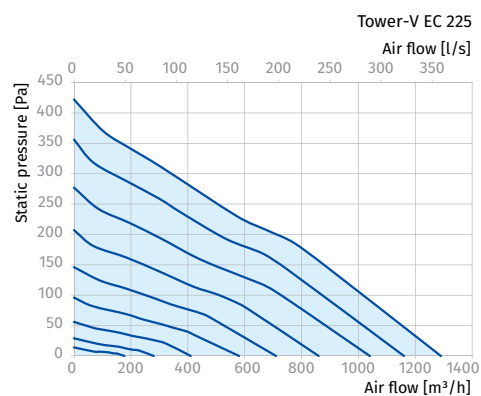
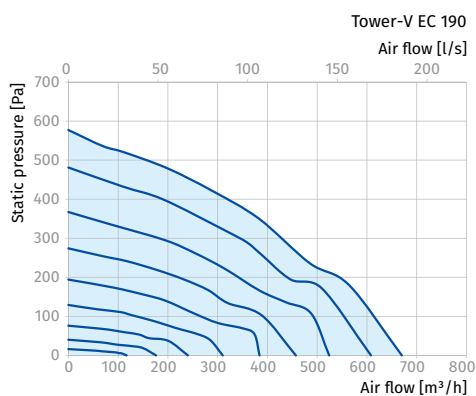

Parameters	Tower-V EC 250	Tower-V EC 280	Tower-V EC 310
Voltage [V]	1 ~ 230	1 ~ 230	1 ~ 230
Frequency [Hz]	50/60	50/60	50/60
Power [W]	161	182	391
Current [A]	1.29	1.34	1.72
Maximum air flow [m³/h (l/s)]	1 470 (408)	2 330 (647)	3 100 (861)
RPM [min ⁻¹]	3300	2610	2600
Sound pressure at 3 m [dBA]	54	48	49
Transported air temperature [°C]	-25...+60	-20...+60	-20...+60
SEC class	-	-	-
IP rating	IPX4	IPX4	IPX4
Motor IP rating	IP55	IP44	IP54
ErP	2018	2018	2018

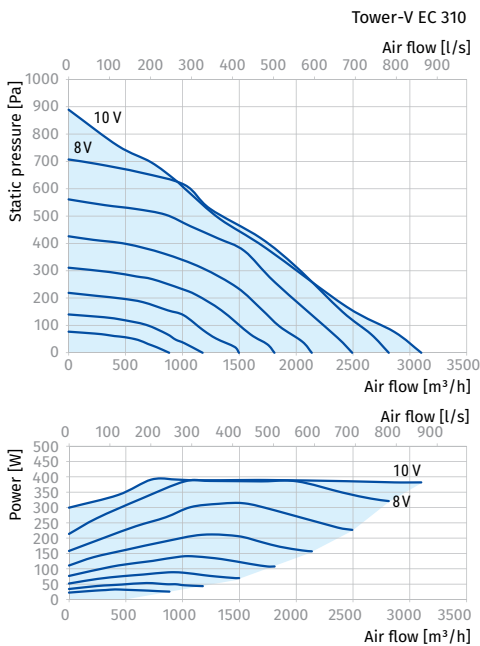
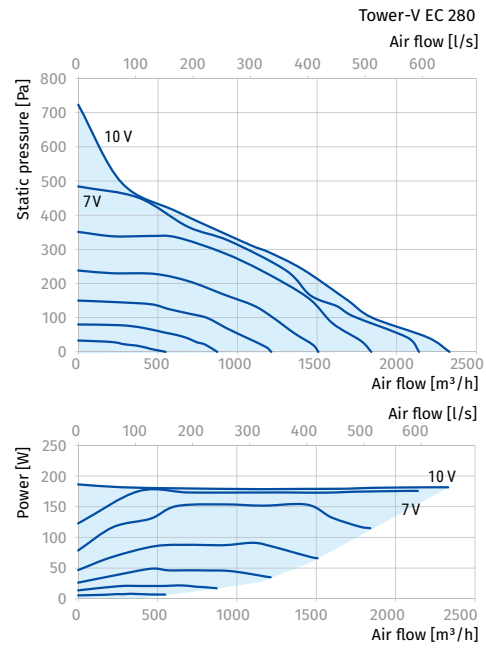
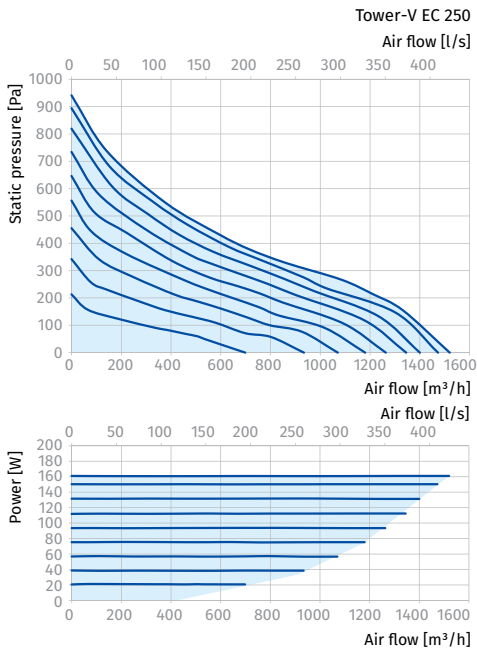

Parameters	Tower-V EC 355	Tower-V EC 400	Tower-V EC 450
Voltage [V]	1 ~ 230	1 ~ 230	3 ~ 400
Frequency [Hz]	50/60	50/60	50/60
Power [W]	669	526	1323
Current [A]	9.36	3.90	3.27
Maximum air flow [m³/h (l/s)]	3 830 (1064)	5 380 (1495)	8 110 (2253)
RPM [min ⁻¹]	1550	1450	1560
Sound pressure at 3 m [dBA]	51	58	63
Transported air temperature [°C]	-25...+50	-25...+50	-20...+60
SEC class	-	-	-
IP rating	IPX4	IPX4	IPX4
Motor IP rating	IP54	IP54	IP54
ErP	2018	2018	2018

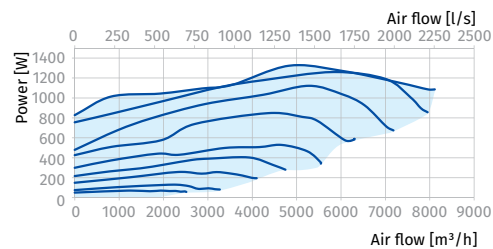
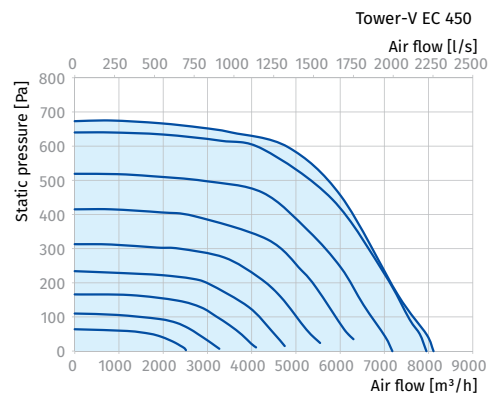
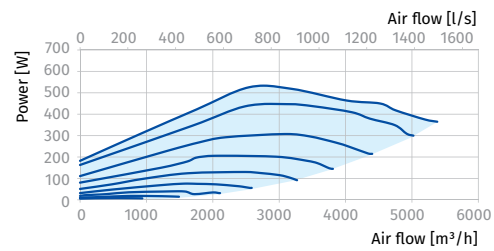
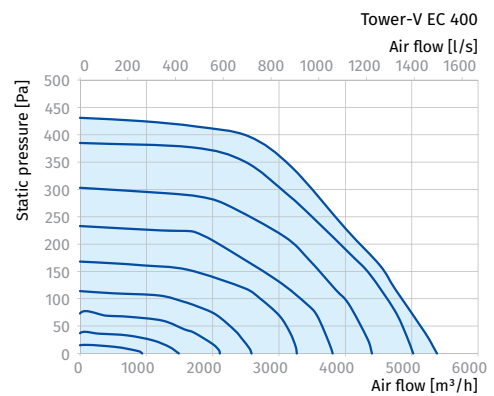
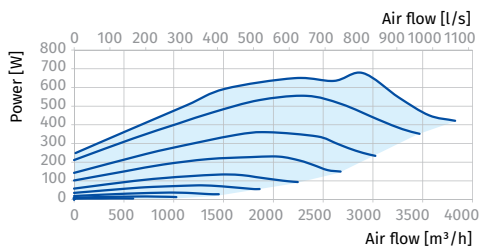
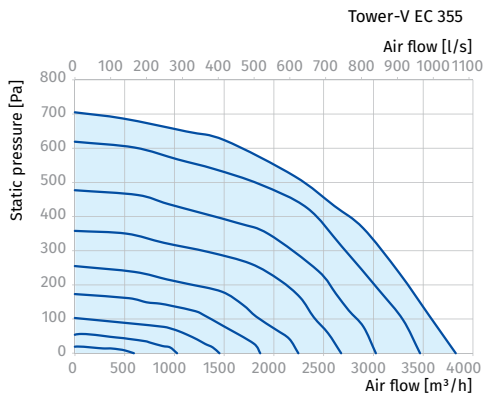

Parameters	Tower-V EC 500	Tower-V EC 560	Tower-V EC 630
Voltage [V]	3 ~ 400	3 ~ 400	3 ~ 400
Frequency [Hz]	50/60	50/60	50/60
Power [W]	1350	2412	2973
Current [A]	2.08	3.83	4.66
Maximum air flow [m³/h (l/s)]	10 900 (3028)	13 640 (3789)	18 270 (5075)
RPM [min ⁻¹]	1480	1540	1450
Sound pressure at 3 m [dBA]	67	69	71
Transported air temperature [°C]	-25...+50	-25...+60	-25...+55
SEC class	-	-	-
IP rating	IPX4	IPX4	IPX4
Motor IP rating	IP54	IP54	IP54
ErP	2018	2018	2018

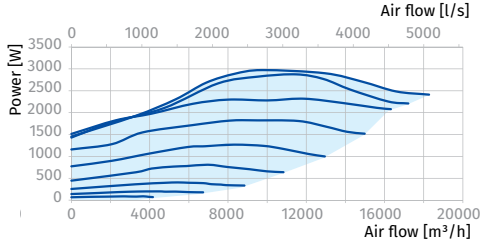
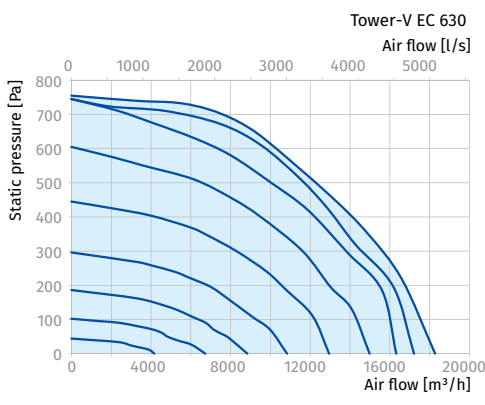
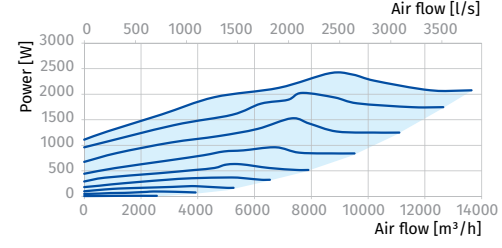
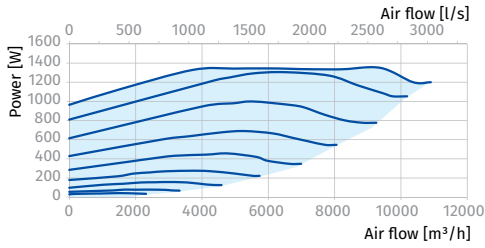
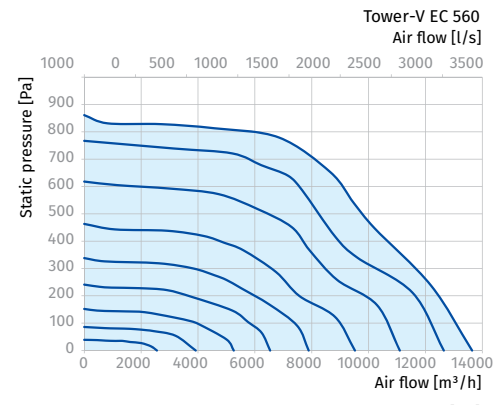
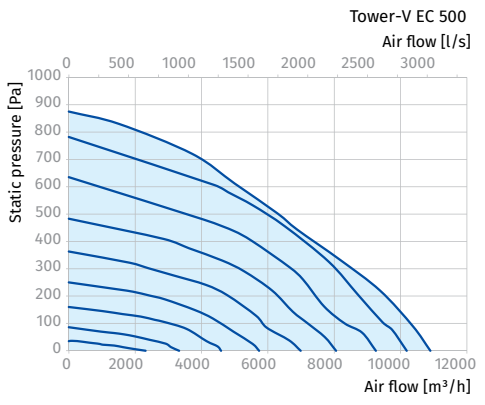

Tower-H

Roof centrifugal fans

Use

- Extract ventilation systems installed in various premises.
- Roof mounting.
- For any types of roofs or vertical ventilation shafts.



Air flow:
up to 17 010 m³/h
4725 l/s



Power:
from 48 W



Noise level:
from 45 dBA



Design

- Steel casing with a special polymer atmospheric resistant coating.
- Horizontal air exhaust.
- The fan is equipped with a terminal block for connection to power mains.
- The fan is rated for continuous operation.
- Impeller with a protecting insect screen.
- The upper cover is equipped with two eye bolts for easy fan lifting on the roof with hoisting mechanism.
- A connecting plate with an intake opening is designed to facilitate mounting to the roof surface.

Motor

- Two-, four- or six-pole asynchronous motor with external rotor and centrifugal impeller with backward curved blades.
- Single-phase (E) or three-phase (D) motor modifications.
- Dynamically balanced impeller.
- Equipped with ball bearings for longer service life.
- Overheating protection by built-in thermal switches with leaded outside terminals for connection to external protecting controls.
- The thermal switch terminal leads are designed for connection to respective circuit of the overload relay or respective terminals of the auto-transformer or thyristor speed controller.

Speed control

- Smooth or step speed control with a thyristor or transformer speed controller (available upon order).

Mounting

- Roof mounting directly above a ventilation shaft or air duct.
- The fan is connected to the air duct with the intake flange that is fixed to the fan base.
- The fan base has holes for fixing bolts that attach the fan to the stable level surface or a roof frame.
- Roof frame and intake flange available on separate order.
- Power is supplied through an external terminal box.

Designation key

Series	Impeller standard size	Motor Number of poles	Phase	Casing material
Tower-H	220; 225; 250; 280; 310; 355; 400; 450; 500	2; 4; 6	E: single-phase D: three-phase	_: steel with polymeric coating A: aluminum

Accessories

Flexible connectors for roof fans	Counterflanges	Mounting frames	Silencers	Backdraft air dampers	Air dampers	Speed controllers
 VDL	 FDL	 MRDL / MRIDL	 SD	 VRV	 VK / VKA	 CDT E1.8

Overall dimensions [mm]

Type	∅D	H	H1	L	L1	Weight [kg]
Tower-H 190 2E	213	189	195	351	350	8.2
Tower-H 220 2E	213	180	186	337	338	7
Tower-H 225 2E	210	210	217	351	350	9.2
Tower-H 225 4E	210	233	240	351	350	8.8
Tower-H 250 2E	285	237	244	451	450	12.7
Tower-H 250 4E	285	237	244	451	450	12.1
Tower-H 280 4E	291	265	272	451	450	13.5
Tower-H 310 2E	291	251	258	451	450	13.2
Tower-H 310 4E	285	287	294	451	450	14.2
Tower-H 310 4D	285	287	294	451	450	14.2
Tower-H 355 4E	438	322	361	625	620	28.3
Tower-H 355 4D	438	347	386	625	620	30.3
Tower-H 400 4E	438	376	415	625	620	35
Tower-H 400 6E	438	376	415	625	620	32.7
Tower-H 400 4D	438	376	415	625	620	35
Tower-H 450 4E	438	420	459	710	700	46.6
Tower-H 450 6E	438	420	459	710	700	45.6
Tower-H 450 4D	438	420	459	710	700	45.5
Tower-H 500 6E	445	461	501	710	700	52.8
Tower-H 500 4D	430	490	530	710	700	46.6
Tower-H 500 6D	445	461	501	710	700	52.7
Tower-H 560 6E	605	489	528	900	895	76.4
Tower-H 560 4D	605	489	528	900	895	81.4
Tower-H 560 6D	605	489	528	900	895	76.4
Tower-H 630 6D	600	520	560	1000	990	96.3
Tower-H 710 6D	674	570	619	1060	1050	134

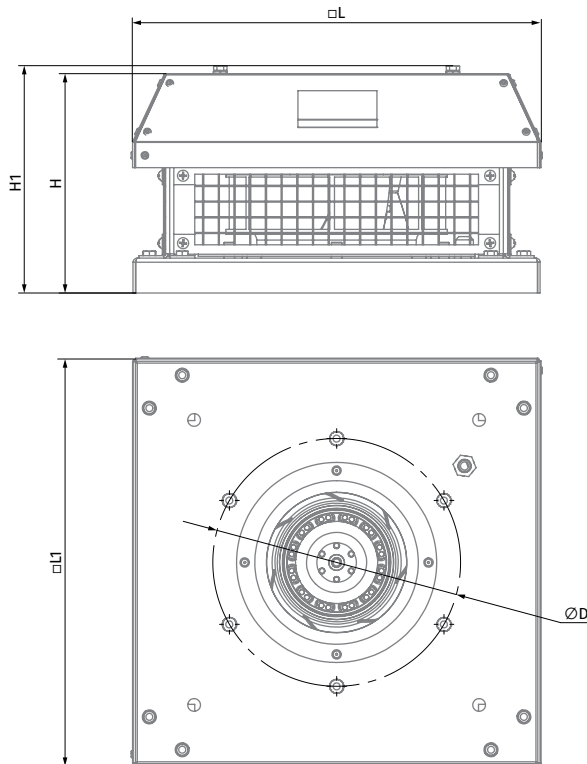

Technical data

Parameters	Tower-H 190 2E		Tower-H 220 2E		Tower-H 225 2E		Tower-H 225 4E	
Voltage [V]	1~230		1~230		1~230		1~230	
Frequency [Hz]	50	60	50	60	50	60	50	
Power [W]	69	89	108	118	123	169	49	
Current [A]	0.30	0.40	0.49	0.54	0.54	0.70	0.22	
Maximum air flow [m ³ /h (l/s)]	610 (169)	654 (182)	880 (244)	883 (245)	915 (254)	1010 (281)	738 (205)	
RPM [min ⁻¹]	2680	2980	2580	2840	2790	2820	1400	
Sound pressure at 3 m [dBA]	48	49	50	51	51	52	45	
Max. transported air temperature [°C]	-25...+50		-25...+50		-25...+50		-25...+50	
SEC class	C	-	C	-	C	-	C	
IP rating	IPX4		IPX4		IPX4		IPX4	
Motor IP rating	IP44		IP44		IP44		IP44	
ErP	2018	-	2018	-	2018	-	2018	

TOWER-H 190 2E

Sound power level, A-weighted	Total	Octave frequency bands [Hz]								LpA 3 m	LpA 1 m
		63	125	250	500	1000	2000	4000	8000		
LWA to inlet [dBA]	68	39	65	63	54	52	49	49	39	47	57
LWA to environment [dBA]	69	28	50	61	64	63	62	54	41	48	58

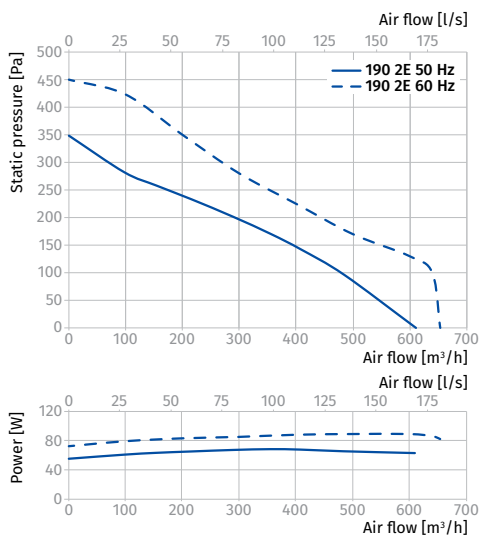
TOWER-H 220 2E

Sound power level, A-weighted	Total	Octave frequency bands [Hz]								LpA 3 m	LpA 1 m
		63	125	250	500	1000	2000	4000	8000		
LWA to inlet [dBA]	70	59	65	65	61	55	55	54	47	49	59
LWA to environment [dBA]	71	46	58	66	65	66	56	51	41	50	60

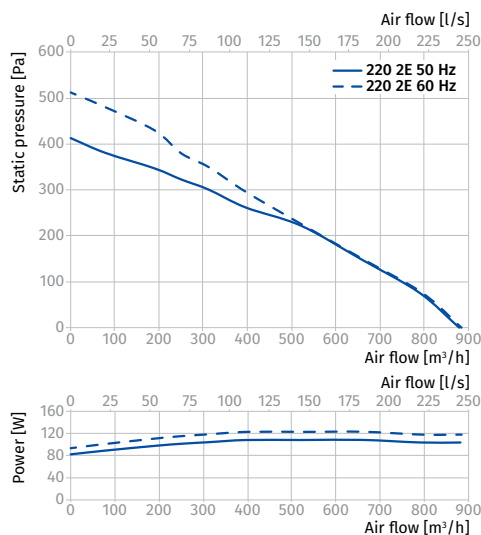
TOWER-H 225 2E

Sound power level, A-weighted	Total	Octave frequency bands [Hz]								LpA 3 m	LpA 1 m
		63	125	250	500	1000	2000	4000	8000		
LWA to inlet [dBA]	71	61	66	66	62	57	57	55	48	51	61
LWA to environment [dBA]	72	47	59	67	66	67	57	52	42	51	61

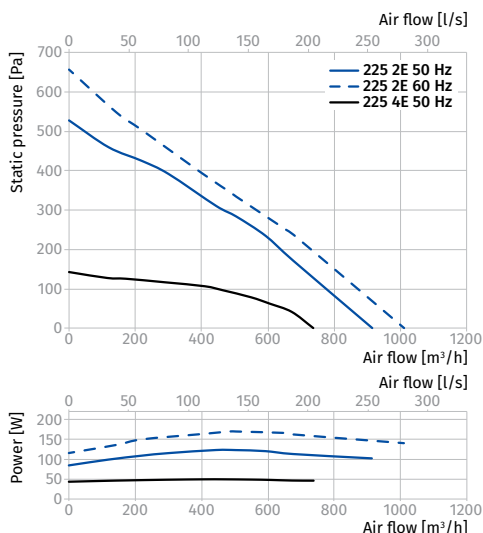

Parameters	Tower-H 250 2E		Tower-H 250 4E	Tower-H 280 4E	
Voltage [V]	1~230		1~230	1~230	
Frequency [Hz]	50	60	50	50	60
Power [W]	184	232	48	125	155
Current [A]	0.81	0.90	0.23	0.61	0.99
Maximum air flow [m³/h (l/s)]	1450 (403)	1320 (367)	820 (228)	1490 (414)	1520 (422)
RPM [min⁻¹]	2480	2320	1440	1446	1710
Sound pressure at 3 m [dBA]	54	53	46	46	46
Max. transported air temperature [°C]	-25...+50		-25...+50	-25...+50	
SEC class	-		-	-	
IP rating	IPX4		IPX4	IPX4	
Motor IP rating	IP44		IP44	IP44	
ErP	2018	-	2018	2018	-

TOWER-H 250 2E, TOWER-H 250 4E

Sound power level, A-weighted	Total	Octave frequency bands [Hz]								LpA 3 m	LpA 1 m
		63	125	250	500	1000	2000	4000	8000		
Tower-H 250 2E											
LWA to inlet [dBA]	75	50	63	70	68	69	66	63	53	54	64
LWA to environment [dBA]	75	51	64	71	67	67	66	62	56	54	64
Tower-H 250 4E											
LWA to inlet [dBA]	68	51	57	60	52	63	62	57	52	47	57
LWA to environment [dBA]	67	29	48	57	60	63	59	51	37	46	56

TOWER-H 280 4E

Sound power level, A-weighted	Total	Octave frequency bands [Hz]								LpA 3 m	LpA 1 m
		63	125	250	500	1000	2000	4000	8000		
LWA to inlet [dBA]	66	46	55	53	59	60	59	55	45	45	55
LWA to environment [dBA]	67	29	48	57	60	63	59	51	37	46	56

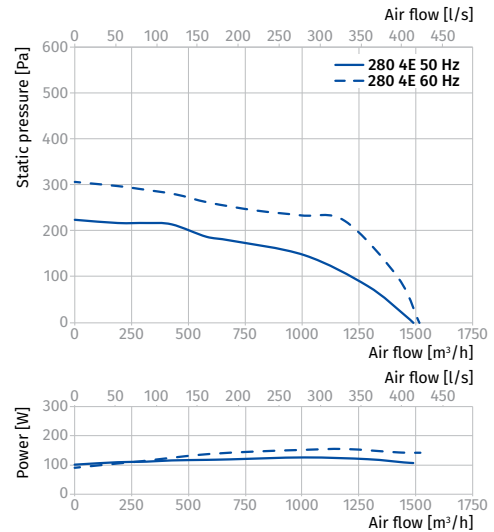
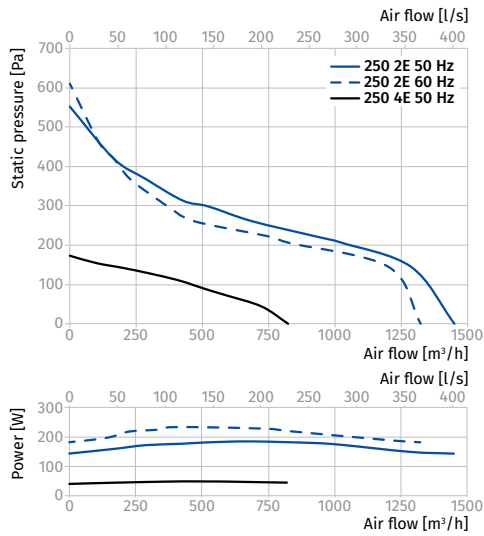

ROOF FANS

Parameters	Tower-H 310 2E	Tower-H 310 4E		Tower-H 310 4D		Tower-H 355 4E		Tower-H 355 4D	
Voltage [V]	1~230	1~230		3~400		1~230		3~400	
Frequency [Hz]	50	50	60	50	60	50	60	50	60
Power [W]	324	141	195	155	202	219	304	264	330
Current [A]	1.42	0.64	0.87	0.29	0.32	0.96	1.33	0.58	0.64
Maximum air flow [m³/h (l/s)]	2150 (597)	2265 (629)	2425 (674)	2300 (639)	2442 (678)	2480 (689)	2976 (827)	3290 (914)	3540 (983)
RPM [min ⁻¹]	2620	1420	1740	1410	1550	1420	1580	1430	1650
Sound pressure at 3 m [dBA]	58	47	49	47	48	51	52	52	53
Max. transported air temperature [°C]	-25...+50	-25...+50		-25...+50		-25...+50		-30...+60	
IP rating	IPX4	IPX4		IPX4		IPX4		IPX4	
Motor IP rating	IP44	IP54		IP54		IP54		IP54	
ErP	2018	2018	-	2018	-	2018	-	2018	-

TOWER-H 310 2E, TOWER-H 310 4E, TOWER-H 310 4D

Sound power level, A-weighted	Total	Octave frequency bands [Hz]								LpA 3 m	LpA 1 m
		63	125	250	500	1000	2000	4000	8000		
Tower-H 310 2E											
LWA to inlet [dBA]	76	47	48	56	69	71	71	69	59	56	66
LWA to environment [dBA]	79	40	48	62	73	74	74	66	49	58	68
Tower-H 310 4E											
LWA to inlet [dBA]	67	47	56	54	61	62	61	57	47	47	57
LWA to environment [dBA]	68	30	49	58	61	65	60	52	38	47	57
Tower-H 310 4D											
LWA to inlet [dBA]	67	46	53	56	62	63	58	55	43	47	57
LWA to environment [dBA]	67	55	59	56	58	63	58	58	39	47	57

TOWER-H 355 4E, TOWER-H 355 4D

Sound power level, A-weighted	Total	Octave frequency bands [Hz]								LpA 3 m	LpA 1 m
		63	125	250	500	1000	2000	4000	8000		
Tower-H 355 4E											
LWA to inlet [dBA]	69	42	43	50	62	64	64	62	53	49	59
LWA to environment [dBA]	72	36	43	56	66	67	67	60	44	51	61
Tower-H 355 4D											
LWA to inlet [dBA]	71	43	44	52	63	66	66	64	54	50	60
LWA to environment [dBA]	73	36	44	57	67	68	68	60	45	52	62

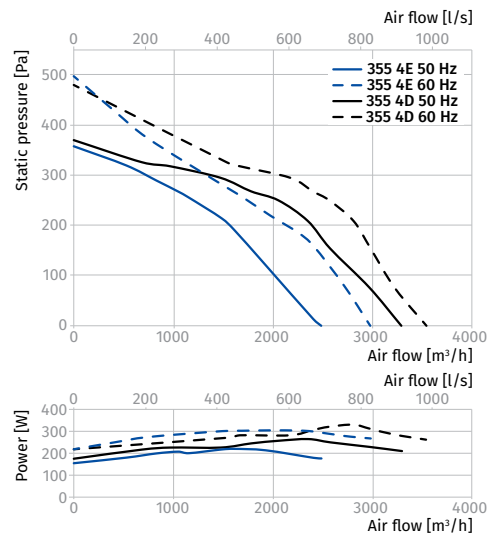
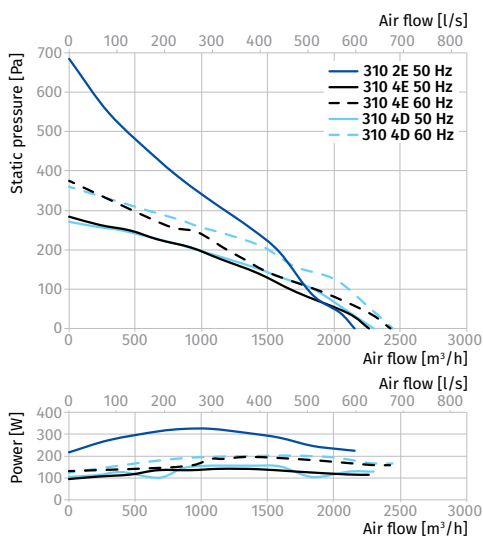

Parameters	Tower-H 400 4E	Tower-H 400 6E		Tower-H 400 4D	Tower-H 450 4E	Tower-H 450 6E	Tower-H 450 4D
Voltage [V]	1~230	1~230		3~400	1~230	1~230	3~400
Frequency [Hz]	50	50	60	50	50	50	50
Power [W]	457	184	249	420	749	268	755
Current [A]	2.00	0.89	1.10	0.99	3.35	1.25	1.50
Maximum air flow [m³/h (l/s)]	3950 (1097)	2740 (761)	3289 (914)	3950 (1097)	6180 (1717)	4380 (1217)	5920 (1644)
RPM [min⁻¹]	1440	945	1071	1440	1400	940	1440
Sound pressure at 3 m [dBA]	55	47	49	55	58	50	57
Max. transported air temperature [°C]	-30...+60	-30...+60		-30...+60	-30...+60	-30...+60	-30...+50
IP rating	IPX4	IPX4		IPX4	IPX4	IPX4	IPX4
Motor IP rating	IP54	IP54		IP54	IP54	IP54	IP54
ErP	2018	2018	-	2018	2018	2018	2018

TOWER-H 400 4E, TOWER-H 400 4D, TOWER-H 400 6E

Sound power level, A-weighted	Total	Octave frequency bands [Hz]								LpA 3 m	LpA 1 m
		63	125	250	500	1000	2000	4000	8000		
Tower-H 400 4E											
LWA to inlet [dBA]	75	46	47	55	67	70	70	68	57	54	64
LWA to environment [dBA]	76	38	46	59	70	71	71	63	47	55	65
Tower-H 400 4D											
LWA to inlet [dBA]	75	44	73	70	60	58	55	54	43	54	64
LWA to environment [dBA]	76	30	56	68	71	70	69	60	46	55	65
Tower-H 400 6E											
LWA to inlet [dBA]	65	44	51	54	60	61	56	52	41	45	55
LWA to environment [dBA]	67	55	59	56	58	63	58	58	39	47	57

TOWER-H 450 4E, TOWER-H 450 4D, TOWER-H 450 6E

Sound power level, A-weighted	Total	Octave frequency bands [Hz]								LpA 3 m	LpA 1 m
		63	125	250	500	1000	2000	4000	8000		
Tower-H 450 4E											
LWA to inlet [dBA]	78	45	75	73	62	60	57	56	45	57	67
LWA to environment [dBA]	78	31	58	70	74	73	71	62	47	58	68
Tower-H 450 4D											
LWA to inlet [dBA]	77	45	74	72	61	60	56	55	45	56	66
LWA to environment [dBA]	77	31	57	69	73	71	70	61	46	57	67
Tower-H 450 6E											
LWA to inlet [dBA]	68	46	54	57	63	64	59	55	43	48	58
LWA to environment [dBA]	70	58	62	59	61	66	60	61	41	50	60

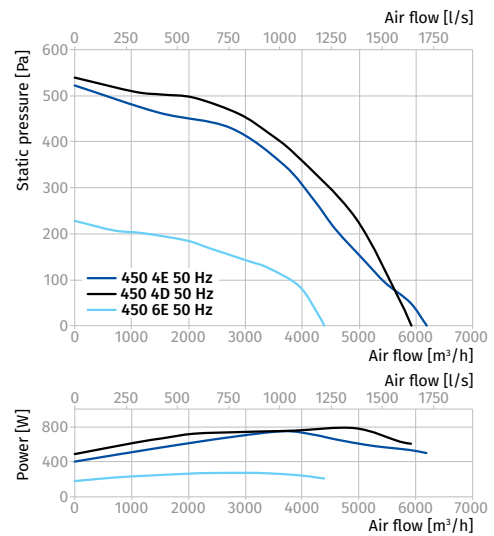
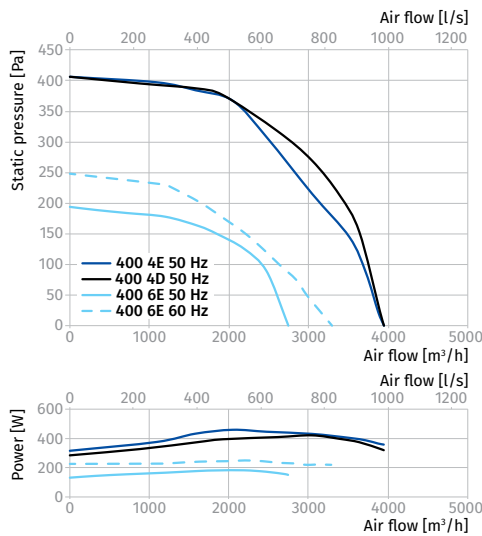

ROOF FANS

Parameters	Tower-H 500 4D	Tower-H 500 6E		Tower-H 500 6D		Tower-H 560 4D	Tower-H 560 6E	Tower-H 560 6D
Voltage [V]	3~400	1~230		3~400		3~400	1~230	3~400
Frequency [Hz]	50	50	60	50	60	50	50	50
Power [W]	1527	407	673	440	599	1970	613	696
Current [A]	2.64	1.81	3.05	1.23	1.32	3.36	2.70	1.44
Maximum air flow [m³/h (l/s)]	8435 (2343)	5680 (1578)	6532 (1814)	6000 (1667)	6122 (1701)	13 560 (3767)	9560 (2656)	9630 (2675)
RPM [min ⁻¹]	1460	970	1120	978	1125	1400	930	970
Sound pressure at 3 m [dBA]	62	52	54	52	54	66	58	58
Max. transported air temperature [°C]	-30...+50	-25...+60		-25...+60		-25...+50	-25...+50	-25...+50
IP rating	IPX4	IPX4		IPX4		IPX4	IPX4	IPX4
Motor IP rating	IP54	IP54		IP54		IP54	IP54	IP54
ErP	2018	2018	-	2018	-	2018	2018	2018

TOWER-H 500 4D, TOWER-H 500 6E, TOWER-H 500 6D

Sound power level, A-weighted	Total	Octave frequency bands [Hz]								LpA 3 m	LpA 1 m
		63	125	250	500	1000	2000	4000	8000		
Tower-H 500 4D											
LWA to inlet [dBA]	82	48	80	77	65	64	60	59	48	61	71
LWA to environment [dBA]	83	33	61	74	78	77	76	65	50	62	72
Tower-H 500 6E											
LWA to inlet [dBA]	70	48	56	59	66	66	61	57	45	50	60
LWA to environment [dBA]	72	60	64	60	63	68	62	63	42	52	62
Tower-H 500 6D											
LWA to inlet [dBA]	70	48	55	58	65	66	61	57	44	49	59
LWA to environment [dBA]	72	60	64	60	63	68	62	63	42	52	62

TOWER-H 560 4D, TOWER-H 560 6E, TOWER-H 560 6D

Sound power level, A-weighted	Total	Octave frequency bands [Hz]								LpA 3 m	LpA 1 m
		63	125	250	500	1000	2000	4000	8000		
Tower-H 560 4D											
LWA to inlet [dBA]	85	50	83	80	68	66	62	61	49	64	74
LWA to environment [dBA]	87	35	65	78	82	81	80	69	53	66	76
Tower-H 560 6E											
LWA to inlet [dBA]	77	64	69	71	70	67	67	66	59	56	66
LWA to environment [dBA]	79	52	65	74	73	74	63	57	46	58	68
Tower-H 560 6D											
LWA to inlet [dBA]	77	65	70	71	71	68	68	67	59	57	67
LWA to environment [dBA]	79	52	65	74	73	74	63	57	46	58	68

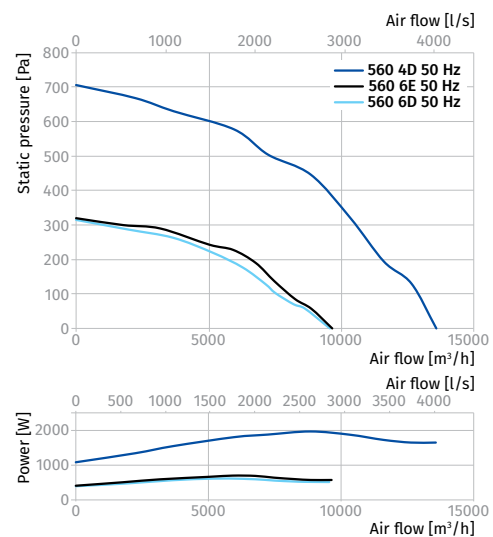
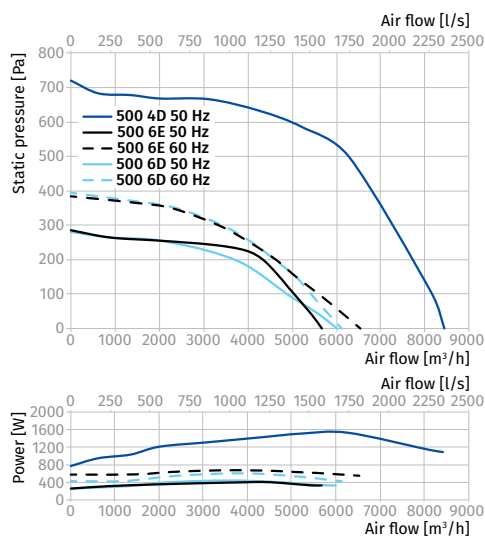

Parameters	Tower-H 630 6D	Tower-H 710 6D
Voltage [V]	3~400	3~400
Frequency [Hz]	50	50
Power [W]	1110	2583
Current [A]	2.42	4.87
Maximum air flow [m³/h (l/s)]	12 640 (3511)	17 010 (4725)
RPM [min ⁻¹]	957	945
Sound pressure at 3 m [dBA]	64	67
Max. transported air temperature [°C]	-25...+50	-25...+70
IP rating	IPX4	IPX4
Motor IP rating	IP54	IP54
ErP	2018	2018

TOWER-H 630 6D

Sound power level, A-weighted	Total	Octave frequency bands [Hz]								LpA 3 m	LpA 1 m
		63	125	250	500	1000	2000	4000	8000		
LWA to inlet [dBA]	82	69	74	76	75	72	72	71	63	61	71
LWA to environment [dBA]	85	56	70	80	79	80	68	62	50	64	74

TOWER-H 710 6D

Sound power level, A-weighted	Total	Octave frequency bands [Hz]								LpA 3 m	LpA 1 m
		63	125	250	500	1000	2000	4000	8000		
LWA to inlet [dBA]	85	72	78	80	79	76	76	75	66	65	75
LWA to environment [dBA]	88	58	73	83	82	83	71	64	52	67	77

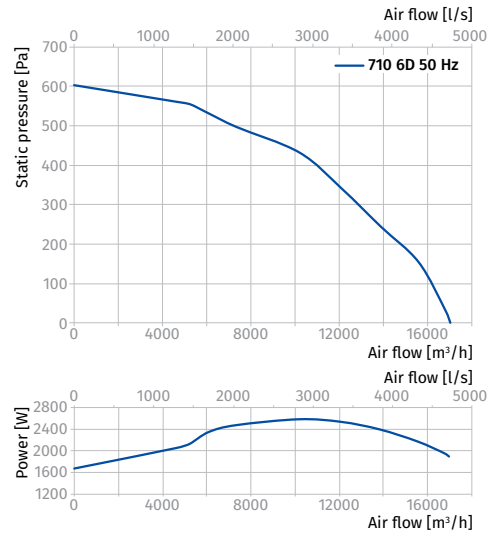
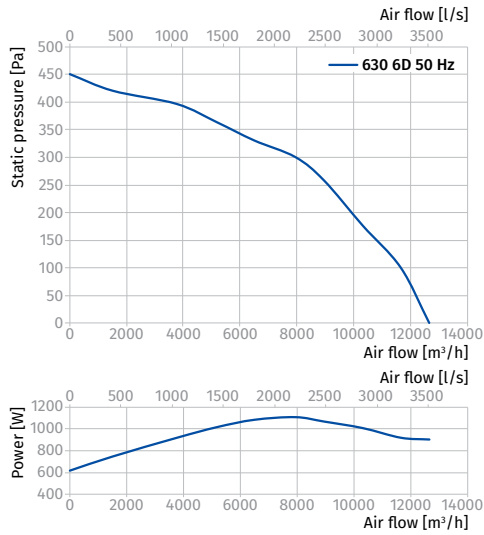

ROOF FANS

Tower-H EC

Roof centrifugal fans with EC motor

Use

- Extract ventilation systems installed in various premises.
- Roof mounting.
- Any roof types or vertical ventilation shafts.
- For arranging energy-saving and controllable ventilation systems.



Air flow:
up to 18270 m³/h
5075 l/s



Power:
from 101 W



Noise level:
from 47 dBA



Design

- The casing is made of steel with a polymer atmospheric resistant coating.
- Horizontal air exhaust.
- The fan is equipped with a terminal box for connection to power mains.
- The fan is rated for continuous operation always connected to power mains.
- The impeller has a protecting grille.
- The upper cover is equipped with two eye bolts for easy fan lifting on the roof with hoisting mechanism.
- A connecting plate is provided to facilitate mounting to the roof surface or to the mounting frame.

Motor

- High-efficient direct current EC motor with external rotor and backward curved blades.
- EC technology meets the up-to-date requirements to energy-saving and controllable ventilation and provides up to 35 % energy saving as compared to asynchronous motors.
- EC motor ensures totally controllable speed range for the fan and has integrated overheating protection with automatic restart.
- EC motor has no friction and wearing parts as capacitor und brushes. Instead a maintenance-free EC controller electronic circuit board is used.
- The impeller is dynamically balanced.
- The fan is compatible with 50 Hz and 60 Hz power mains and the maximum speed does not depend on power mains frequency.

Operation and speed control

- The fan speed is controlled with a 0–10 V control signal from the following sources:
 - integrated or external speed controller
 - controller with sensors
 - central BMS system.
- The control signal value changes depending on air temperature, pressure, smoke concentration and other parameters.
- During signal value change the fan with EC motor correspondingly changes the rotations speed and delivers required air volume to the ventilation system.
- The computer central building management systems (BMS) enable integration of several EC motors in network and precise individual operation control for each fan.

Mounting

- Roof mounting directly above a ventilation shaft or an air duct.
- The fan is attached to a square air duct or to the **MRDL/MRIDL** mounting frame (see accessories).
- The counterflange **FDL** mounted on the fan bottom (see accessories) is designed for the fan connection to a round air duct.
- The **KDL** backdraft dampers (see Accessories) are designed to prevent air back drafting when the fan is off.
- The **VDL** flexible connectors (see Accessories) are designed to absorb vibration from the fan to the air duct.
- External terminal box for connection to power mains.

Designation key

Series	Motor type	Impeller standard size	Casing material
Tower-H	EC: electronically commutated motor	190; 225; 250; 280; 310; 355; 400; 450; 500; 560; 630	_: steel with polymeric coating A: aluminum

Accessories

Backdraft dampers	Flexible connectors for roof fans	Counterflanges	Mounting frames	Silencers	Backdraft air dampers	Air dampers	Speed controllers
KDL	VDL	FDL	MRDL / MRIDL	SD	VRV	VK / VKA	CDT E/0-10

Overall dimensions [mm]

Type	∅ D	∅ d	H	L	L1	L2	Weight [kg]
Tower-H EC 190	213	11	189	350	245	351	8
Tower-H EC 225	213	11	234	350	245	351	8
Tower-H EC 250	285	11	237	450	330	451	13
Tower-H EC 280	285	11	263	450	330	451	13
Tower-H EC 310	285	11	263	450	330	451	16
Tower-H EC 355	438	11	322	620	450	625	27
Tower-H EC 400	438	11	384	620	450	625	27
Tower-H EC 450	438	11	420	700	535	710	46
Tower-H EC 500	445	11	467	700	535	710	51
Tower-H EC 560	605	11	489	895	750	900	71
Tower-H EC 630	600	20	520	990	750	1000	101

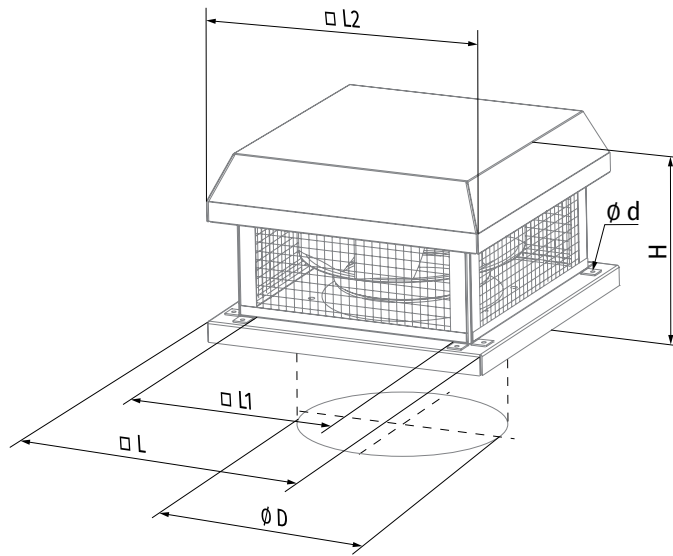

Technical data

Parameters	Tower-H EC 190	Tower-H EC 225
Voltage [V]	1 ~ 230	1 ~ 230
Frequency [Hz]	50/60	50/60
Power [W]	102	101
Current [A]	0.77	0.80
Maximum air flow [m³/h (l/s)]	670 (186)	1290 (358)
RPM [min ⁻¹]	3520	2400
Sound pressure at 3 m [dBA]	52	47
Transported air temperature [°C]	-25...+60	-25...+60
SEC class	B	-
IP rating	IPX4	IPX4
Motor IP rating	IP55	IP55
ErP	2018	2018

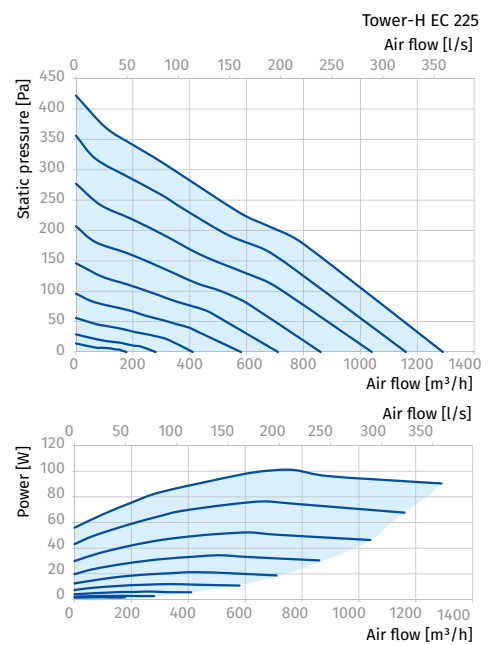
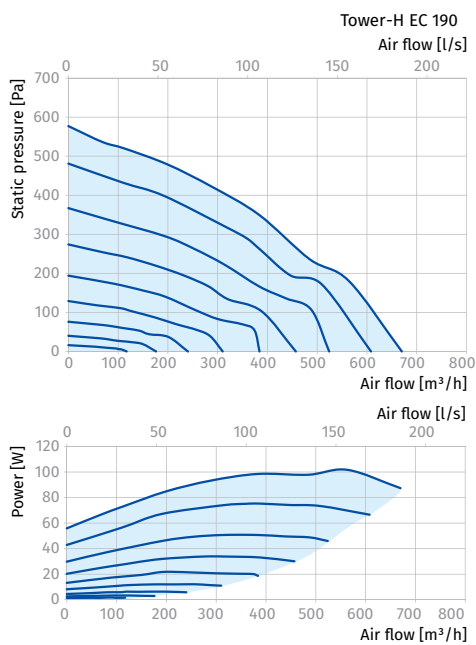

Parameters	Tower-H EC 250	Tower-H EC 280	Tower-H EC 310
Voltage [V]	1 ~ 230	1 ~ 230	1 ~ 230
Frequency [Hz]	50/60	50/60	50/60
Power [W]	161	182	391
Current [A]	1.29	1.34	1.72
Maximum air flow [m³/h (l/s)]	1 470 (408)	2 330 (647)	3 100 (861)
RPM [min ⁻¹]	3300	2610	2600
Sound pressure at 3 m [dBA]	54	48	49
Transported air temperature [°C]	-25...+60	-20...+60	-20...+60
SEC class	-	-	-
IP rating	IPX4	IPX4	IPX4
Motor IP rating	IP55	IP44	IP54
ErP	2018	2018	2018

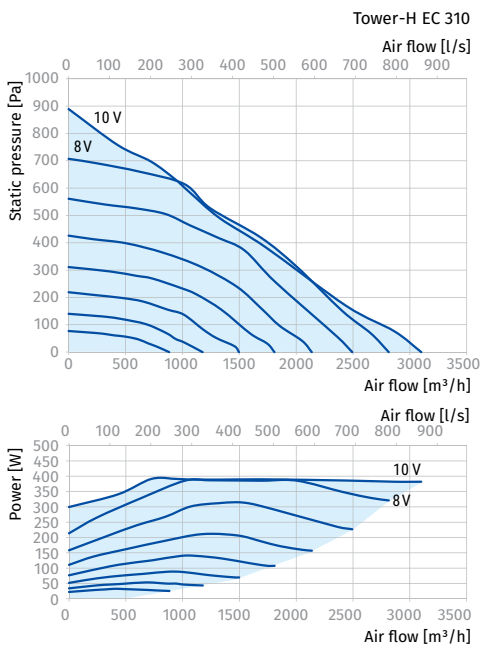
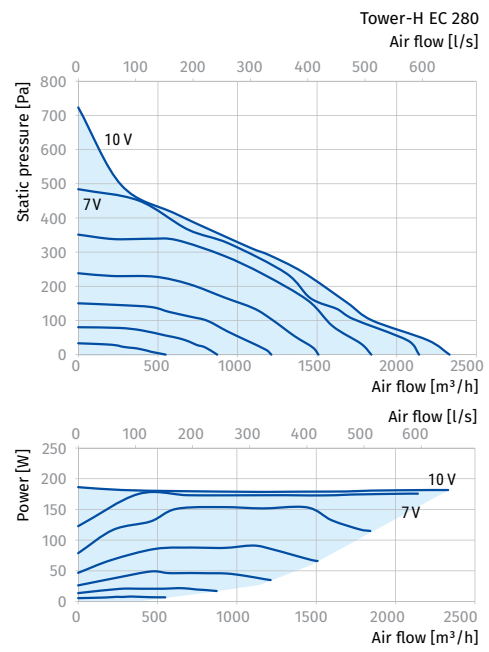
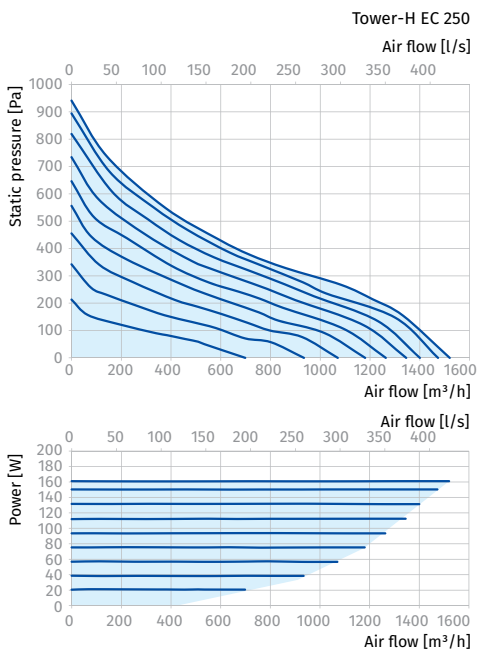

Parameters	Tower-H EC 355	Tower-H EC 400	Tower-H EC 450
Voltage [V]	1 ~ 230	1 ~ 230	3 ~ 400
Frequency [Hz]	50/60	50/60	50/60
Power [W]	669	526	1323
Current [A]	9.36	3.90	3.27
Maximum air flow [m³/h (l/s)]	3 830 (1064)	5 380 (1495)	8 110 (2253)
RPM [min ⁻¹]	1550	1450	1560
Sound pressure at 3 m [dBA]	51	58	63
Transported air temperature [°C]	-25...+50	-25...+50	-20...+60
SEC class	-	-	-
IP rating	IPX4	IPX4	IPX4
Motor IP rating	IP54	IP54	IP54
ErP	2018	2018	2018

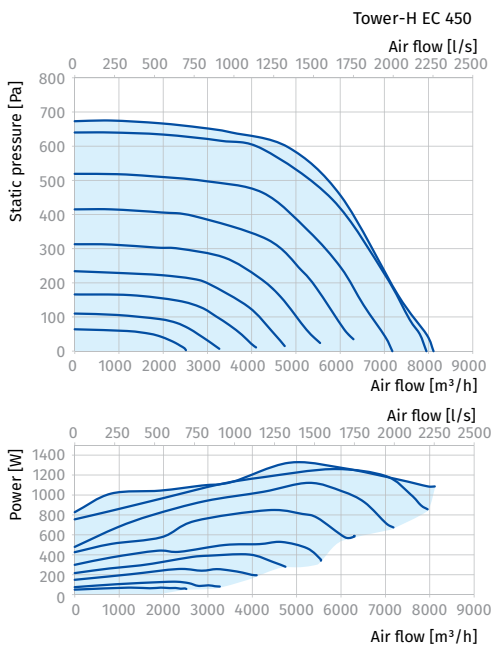
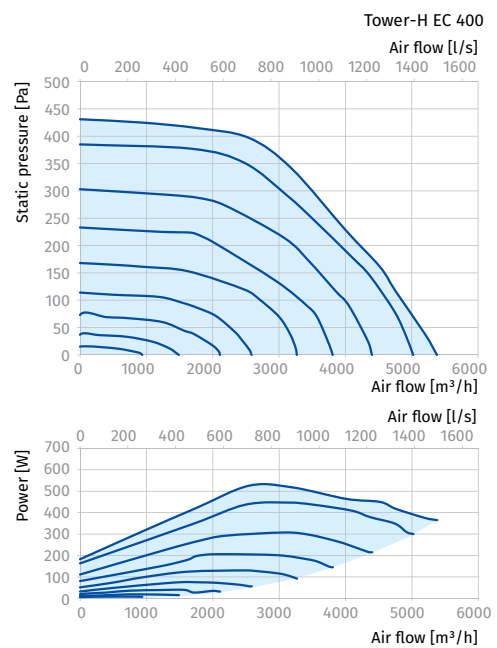
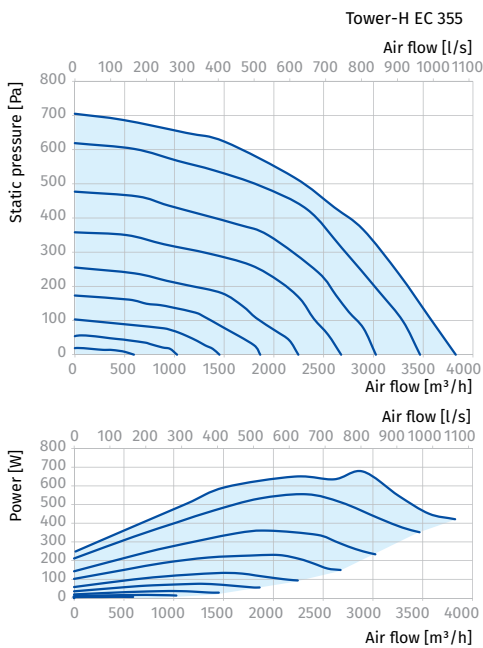

Parameters	Tower-H EC 500	Tower-H EC 560	Tower-H EC 630
Voltage [V]	3 ~ 400	3 ~ 400	3 ~ 400
Frequency [Hz]	50/60	50/60	50/60
Power [W]	1350	2412	2973
Current [A]	2.08	3.83	4.66
Maximum air flow [m³/h (l/s)]	10 900 (3028)	13 640 (3789)	18 270 (5075)
RPM [min ⁻¹]	1480	1540	1450
Sound pressure at 3 m [dBA]	67	69	71
Transported air temperature [°C]	-25...+50	-25...+60	-25...+55
SEC class	-	-	-
IP rating	IPX4	IPX4	IPX4
Motor IP rating	IP54	IP54	IP54
ErP	2018	2018	2018

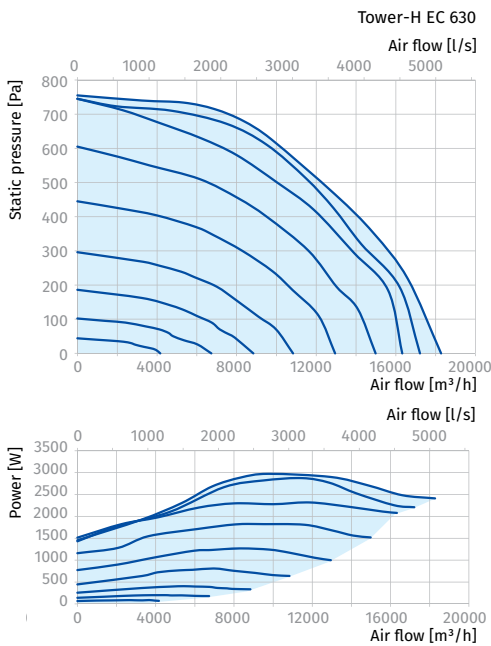
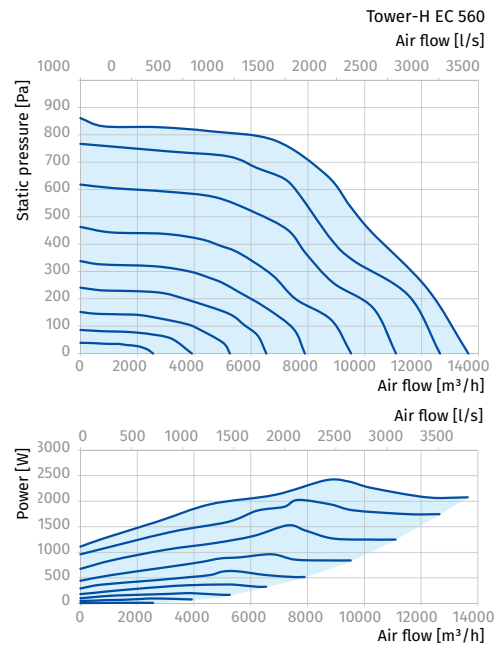
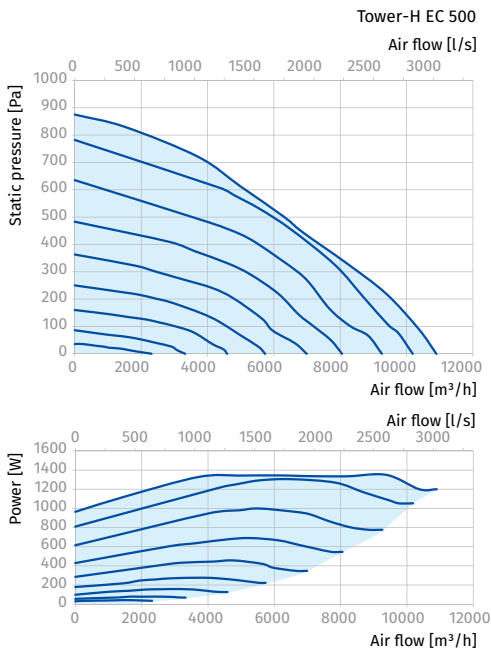

ROOF FANS

Tower-AM

Roof centrifugal fans

Use

- Extract ventilation systems installed in various premises.
- Roof mounting.
- For any types of roofs or vertical ventilation shafts.
- Compatible with \varnothing 150 up to 315 mm round air ducts.



Air flow:
up to 1920 m³/h
533 l/s



Power:
from 98 W



Noise level:
from 47 dBA



Design

- Steel casing with a special polymer atmospheric resistant coating.
- Horizontal air exhaust.
- The fan is rated for continuous operation.
- A connecting plate is designed to facilitate the fan mounting to the roof surface.

Motor

- Single-phase external rotor motor and centrifugal impeller with backward curved blades.
- Dynamically balanced impeller.
- Equipped with ball bearings for longer service life.
- Overheating protection with built-in thermal switches with automatic restart.

Speed control

- Smooth or step speed control with an external thyristor controller or an external auto transformer (both available upon separate order).

Mounting

- Roof mounting directly above a ventilation shaft or air duct.
- The fan is connected to the air duct with the intake flange that is fixed to the fan base.
- The fan base is perforated for fixing bolts that attach the fan to a stable level surface or a roof frame.
- Roof frame, intake flange and fixing bolts are available on separate order.
- Power is supplied through an external terminal box.

Designation key

Series	Spigot diameter [mm]
Tower-AM	150; 200; 250; 315

Overall dimensions [mm]

Type	\varnothing D	\varnothing D1	H	L	L1	Weight [kg]
Tower-AM 150	149	400	230	440	330	7.2
Tower-AM 200	198	400	250	440	330	8.1
Tower-AM 250	248	400	249	590	450	10.1
Tower-AM 315	315	550	339	590	450	12.3

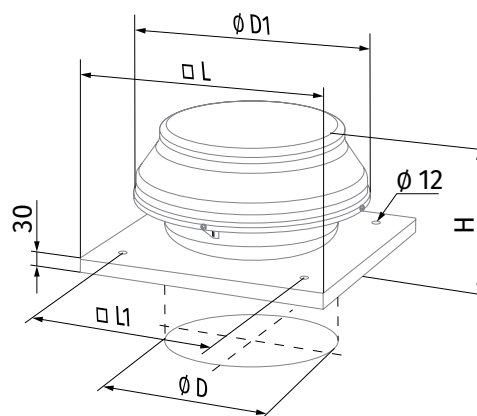

Accessories

Mounting frames	Silencers	Backdraft air dampers	Air dampers	Speed controllers
 MRDL / MRIDL	 SD	 VRV	 VK / VKA	 CDT E1.8

Technical data

Parameters	Tower-AM 150		Tower-AM 200		Tower-AM 250		Tower-AM 315	
Voltage [V]	1 ~ 230		1 ~ 230		1 ~ 230		1 ~ 230	
Frequency [Hz]	50	60	50	60	50	60	50	60
Power [W]	98	119	154	205	194	240	296	413
Current [A]	0.43	0.52	0.67	0.9	0.85	1.05	1.34	1.8
Maximum air flow [m³/h (l/s)]	555 (154)	580 (161)	950 (264)	1000 (278)	1310 (364)	1340 (372)	1880 (522)	1920 (533)
RPM [min⁻¹]	2705	2855	2375	2510	2790	2860	2720	2780
Sound pressure at 3 m [dBA]	47	48	48	50	52	53	54	55
Max. transported air temperature [°C]	-25...+55	-25...+50	-25...+50	-25...+50	-25...+50	-25...+50	-25...+45	-25...+50
SEC class	B		B		-		-	
IP rating	IPX4		IPX4		IPX4		IPX4	
Motor IP rating	IP44		IP44		IP44		IP44	
ErP	2018		2018		2018		2018	

TOWER-AM 150

Sound power level, A-weighted	Total	Octave frequency bands [Hz]							
		63	125	250	500	1000	2000	4000	8000
L _{WA} to inlet [dBA]	71	45	65	64	63	61	60	48	39
L _{WA} to environment [dBA]	64	39	59	55	37	20	17	26	20

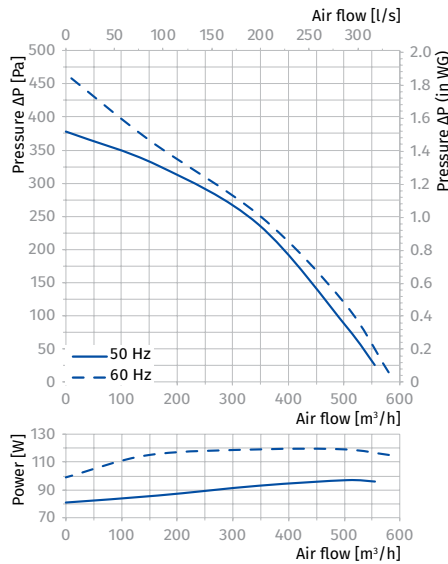

TOWER-AM 200

Sound power level, A-weighted	Total	Octave frequency bands [Hz]							
		63	125	250	500	1000	2000	4000	8000
L _{WA} to inlet [dBA]	77	49	69	67	72	65	61	58	50
L _{WA} to environment [dBA]	64	45	63	61	48	31	25	47	41

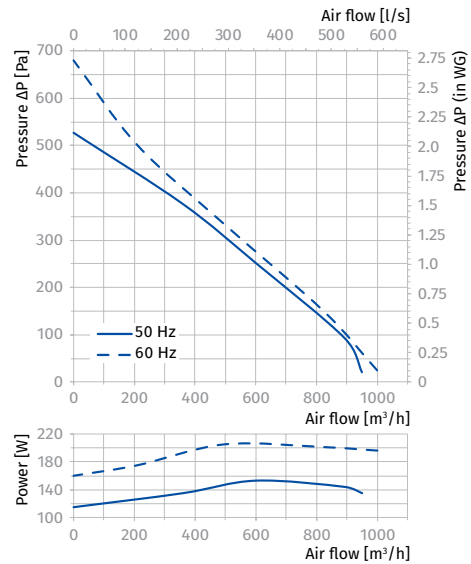

TOWER-AM 250

Sound power level, A-weighted	Total	Octave frequency bands [Hz]							
		63	125	250	500	1000	2000	4000	8000
L _{WA} to inlet [dBA]	72	58	65	66	69	66	62	53	47
L _{WA} to environment [dBA]	65	57	64	60	49	39	39	44	40

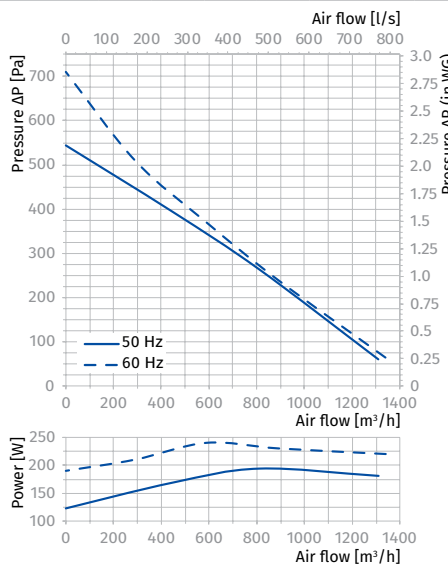

TOWER-AM 315

Sound power level, A-weighted	Total	Octave frequency bands [Hz]							
		63	125	250	500	1000	2000	4000	8000
L _{WA} to inlet [dBA]	77	55	67	68	72	68	66	62	60
L _{WA} to environment [dBA]	68	52	64	63	55	47	52	57	50

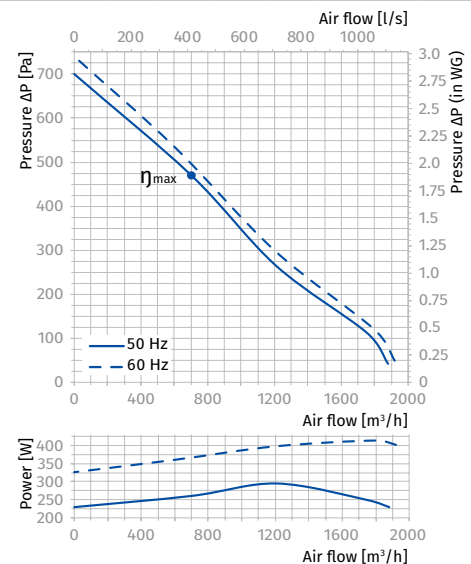

ROOF FANS

Tower-A

Roof axial fans

Use

- Extract ventilation systems installed in various premises.
- Roof mounting.
- For any types of roofs or vertical ventilation shafts.



Air flow:
up to 2650 m³/h
736 l/s



Power:
from 50 W



Noise level:
from 50 dBA



Design

- Steel casing and impeller with a special polymer atmospheric resistant coating.
- Horizontal air exhaust.
- The fan is equipped with a terminal block for connection to power mains.
- The fan is rated for continuous operation.
- A connecting plate with an intake opening is designed to facilitate mounting to the roof surface.

Motor

- Two- or four-pole asynchronous motor with external rotor and axial impeller.
- Single-phase (E) motor modification.
- Equipped with ball bearings for longer service life.
- Overheating protection by built-in thermal switches with automatic restart.

Speed control

- Smooth speed control with an external thyristor controller or step speed control with an external auto transformer (both available upon separate order).

Mounting

- Roof mounting directly above a ventilation shaft or air duct.
- The fan is connected to the air duct with the intake flange that is fixed to the fan base.
- The fan base has holes for fixing bolts that attach the fan to a stable level surface or a roof frame.
- Roof frame and intake flange available on separate order.
- Power is supplied through an external terminal box.

Designation key

Series	Spigot diameter [mm]	Motor Number of poles	Phase	Casing material
Tower-A	200; 250; 300; 350	2; 4	E: single-phase	┘: polymer coated steel A: aluminum

Overall dimensions [mm]

Type	∅ D	∅ D1	H	L	L1	Weight [kg]
Tower-A 200 2E	208	345	280	425	330	5.0
Tower-A 250 2E	262	405	280	425	330	7.0
Tower-A 250 4E	262	405	280	425	330	7.0
Tower-A 300 2E	314	555	340	585	450	10.5
Tower-A 300 4E	314	555	340	585	450	10.5
Tower-A 350 4E	364	555	350	655	535	12.0

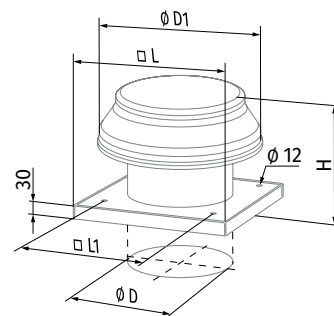

Accessories

Mounting frames	Silencers	Backdraft air dampers	Air dampers	Speed controllers
 MRDL / MRDL	 SD	 VRV	 VK / VKA	 CDT E1.8

Technical data

Parameters	Tower-A 200 2E		Tower-A 250 2E		Tower-A 250 4E		Tower-A 300 2E		Tower-A 300 4E		Tower-A 350 4E	
Voltage [V]	1 ~ 230		1 ~ 230		1 ~ 230		1 ~ 230		1 ~ 230		1 ~ 230	
Frequency [Hz]	50	60	50	60	50	60	50	60	50	60	50	60
Power [W]	55	61	80	91	50	56	145	178	75	92	140	147
Current [A]	0.26	0.28	0.4	0.42	0.22	0.24	0.66	0.79	0.35	0.4	0.65	0.66
Maximum air flow [m³/h (l/s)]	860 (239)	875 (243)	1050 (292)	1150 (319)	800 (222)	865 (240)	2230 (619)	2280 (633)	1340 (372)	1475 (410)	2500 (695)	2650 (736)
RPM [min⁻¹]	2300	2550	2400	2990	1380	1730	2300	2410	1350	1405	1380	1700
Sound pressure at 3 m [dBA]	50	51	60	61	55	56	60	61	58	59	62	63
Transported air temperature [°C]	-30...+60	-30...+50	-30...+60	-30...+50	-30...+60	-30...+50	-30...+60	-30...+50	-30...+60	-30...+50	-30...+60	-30...+50
SEC class	-		-		-		-		B		-	
IP rating	IP24		IP24		IP24		IP24		IP24		IP24	
Motor IP rating	IP44		IP44		IP44		IP44		IP44		IP44	
ErP	-		-		-		2018		2018		2018	

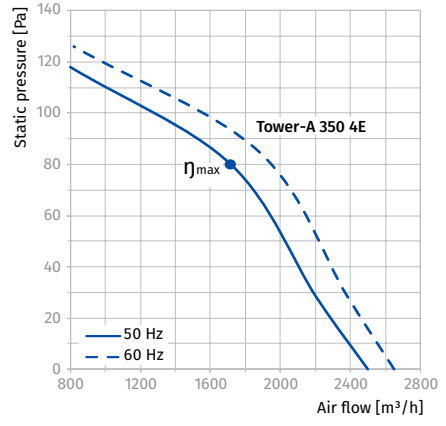
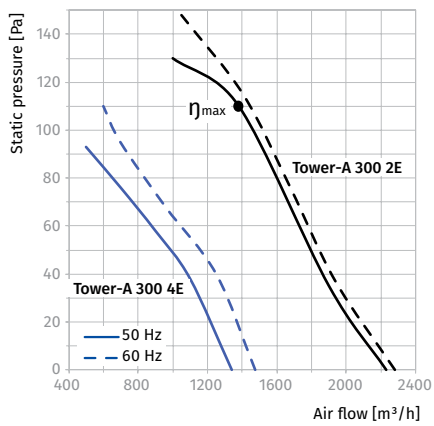
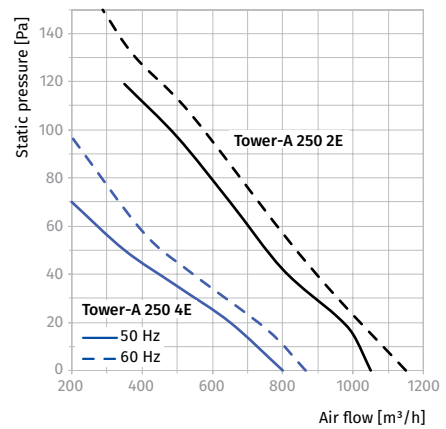
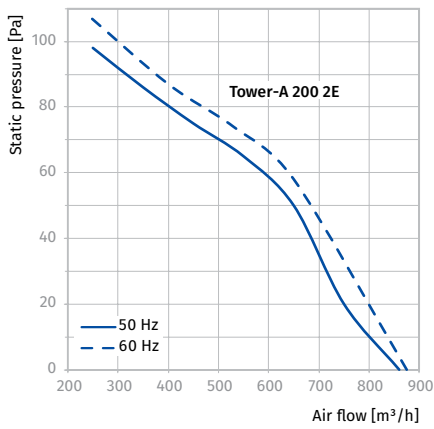

ROOF FANS

Tower-AL

Roof axial fans

Use

- Extract ventilation systems installed in various premises.
- Roof mounting.
- For any types of roofs or vertical ventilation shafts.



Air flow:
up to 1700 m³/h
472 l/s



Power:
from 43 W



Noise level:
from 32 dBA



Design

- Steel casing with a special polymer atmospheric resistant coating.
- Aluminium impeller.
- Horizontal air exhaust.
- The fan is equipped with a terminal block for connection to power mains.
- The fan is rated for continuous operation.
- A connecting plate with an intake opening is designed to facilitate mounting to the roof surface.

Motor

- Single-phase asynchronous external rotor motor with axial impeller.
- Equipped with ball bearings for longer service life.
- Overheating protection by built-in thermal switches with automatic restart.

Speed control

- Smooth speed control with an external thyristor controller or step speed control with an external auto transformer (both available upon separate order).

Mounting

- Roof mounting directly above a ventilation shaft or air duct.
- The fan is connected to the air duct with the intake flange that is fixed to the fan base.
- The fan base has holes for fixing bolts that attach the fan to a stable level surface or a roof frame.
- Roof frame and intake flange available on separate order.
- Power is supplied through an external terminal box.

Designation key

Series	Spigot diameter [mm]
Tower-AL	200; 250; 315

Overall dimensions [mm]

Type	∅ D	∅ D1	H	L	L1	Weight [kg]
Tower-AL 200	208	345	280	425	330	6.1
Tower-AL 250	262	405	300	425	330	7.2
Tower-AL 315	314	555	380	585	450	11.5

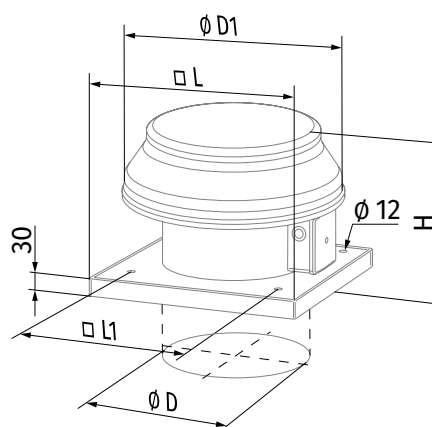

Accessories

Mounting frames	Silencers	Backdraft air dampers	Air dampers	Speed controllers
 MRDL / MRIDL	 SD	 VRV	 VK / VKA	 CDT E1.8

Technical data

Parameters	Tower-AL 200		Tower-AL 250		Tower-AL 315	
Voltage [V]	1 ~ 230		1 ~ 230		1 ~ 230	
Frequency [Hz]	50	60	50	60	50	60
Power [W]	43	33	68	76	110	104
Current [A]	0.28	0.21	0.48	0.51	0.75	0.7
Maximum air flow [m³/h (l/s)]	405 (113)	470 (131)	1070 (297)	1050 (292)	1700 (472)	1650 (458)
RPM [min ⁻¹]	1300	1615	1300	1450	1300	1365
Sound pressure at 3 m [dBA]	32	31	48	48	54	54
Transported air temperature [°C]	40		40		40	
SEC class	-		-		C	
IP rating	IP24		IP24		IP24	
Motor IP rating	IP44		IP44		IP44	
ErP	-		-		-	

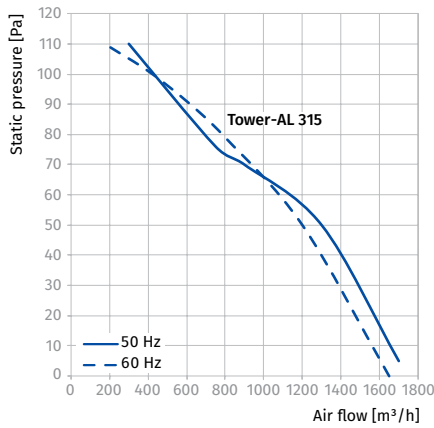
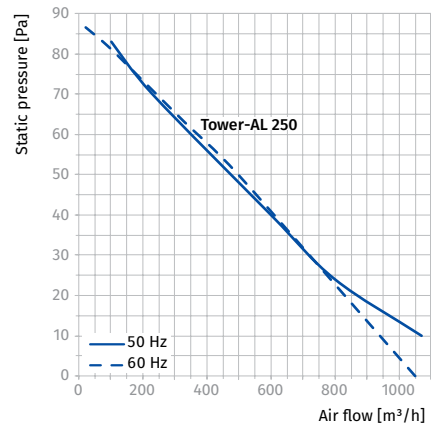
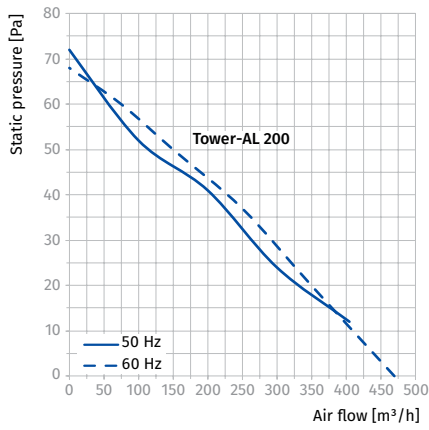

Box

Centrifugal fans for rectangular ducts

Use

- Supply and exhaust ventilation systems installed in various premises.
- Compatible with 400x200 up to 1000x500 mm rectangular air ducts.



Air flow:
up to 15000 m³/h
4167 l/s



Power:
from 136 W



Noise level:
from 50 dBA



Design

- Atmospheric resistant galvanized steel casing.
- The fan is rated for continuous operation.
- Fitted with standard 20 mm connecting flanges for connection to rectangular air ducts.
- Access cover on the casing for inspection and maintenance operations.
- The fan is equipped with a built-in terminal box with a leaded outside sealed electrical lead-in for connection to power mains.

Motor

- Two- or four-pole asynchronous motor with external rotor and centrifugal impeller with backward curved blades.
- Single-phase (**E**) or three-phase (**D**) motor modifications.
- Equipped with ball bearings for longer service life.
- Dynamically balanced impeller.
- Overheating protection by built-in thermal switches with automatic restart or with leaded outside terminals for connection to external protecting controls.
- The thermal switch terminal leads are designed for connection to respective circuit of the contactor, overload relay or respective terminals of the autotransformer or thyristor speed controller.

Speed control

- Smooth speed control with an external thyristor controller or step speed control with an external auto transformer (both available upon separate order).

Mounting

- The fan is designed for mounting inside rectangular air ducts and can be installed in any position.
- The fan flanges are connected to the air ducts through the bolts inserted into the flange holes.
- The fan is suitable for mounting into round duct at intake flange with a round reducer (available upon separate order).
- If vibration-absorbing flexible connectors are used to connect the fan to the air ducts provide their fixation to mounting structures with supports or brackets.
- While mounting provide enough space for accessing the cover for service operations.

INLINE FANS FOR RECTANGULAR DUCTS

Designation key

Series	Flange size (width x height) [cm]	Motor Number of poles	Phase
Box	40x20; 50x25; 50x30; 60x30; 60x35; 100x50	2; 4	E: single-phase D: three-phase

Accessories

Silencers	Filter boxes	Electric heaters	Water heaters	Air dampers	Gravity dampers	Flexible antivibration connectors	Speed controllers
							
SD	KFBK / KFBT	EKH	WKH	SL	VG	EVA	CDTE 1.8

Overall dimensions [mm]

Type	B	B1	H	H1	H2	L	Weight [kg]
Box 40x20 2E	400	440	200	240	240	500	11.25
Box 50x25 2E	500	540	250	290	290	640	17.88
Box 50x30 4E	500	540	300	340	340	680	19.80
Box 50x30 4D	500	540	300	340	340	680	19.80
Box 60x30 4E	600	640	300	340	342	680	27.77
Box 60x30 4D	600	640	300	340	342	680	27.77
Box 60x35 4E	600	640	350	390	390	735	36.38
Box 60x35 4D	600	640	350	390	390	735	36.38
Box 100x50 4D	1000	1040	500	540	720	1150	126.0

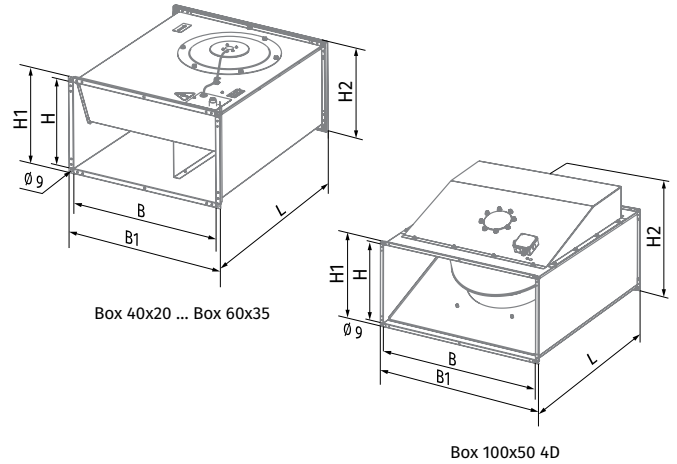

Technical data

Parameters	Box 40x20 2E		Box 50x25 2E	
Voltage [V]	1 ~ 230		1 ~ 230	
Frequency [Hz]	50	60	50	60
Power [W]	138	200	305	380
Current [A]	0.6	0.88	1.32	1.65
Maximum air flow [m³/h (l/s)]	930 (258)	1070 (297)	1720 (478)	1850 (514)
RPM [min⁻¹]	2600	2850	2550	2830
Sound pressure at 3 m [dBA]	50	52	57	58
Transported air temperature [°C]	-25...+45		-25...+45	
IP rating	IPX4		IPX4	
Motor IP rating	IP44		IP44	
ErP	2018		2018	

BOX 40x20 2E

Sound power level, A-weighted	Total	Octave frequency bands [Hz]							LpA 3 m	LpA 1 m	
		63	125	250	500	1000	2000	4000			8000
LWA to inlet [dBA]	78	67	74	74	69	63	63	61	53	58	68
LWA to outlet [dBA]	82	69	74	76	75	72	72	71	63	61	71
LWA to environment [dBA]	71	46	58	66	65	66	56	51	41	50	60

BOX 50x25 2E

Sound power level, A-weighted	Total	Octave frequency bands [Hz]							LpA 3 m	LpA 1 m	
		63	125	250	500	1000	2000	4000			8000
LWA to inlet [dBA]	83	69	77	79	67	70	74	71	66	62	72
LWA to outlet [dBA]	85	69	74	77	76	80	77	77	71	65	75
LWA to environment [dBA]	77	43	60	73	73	70	64	58	48	57	67

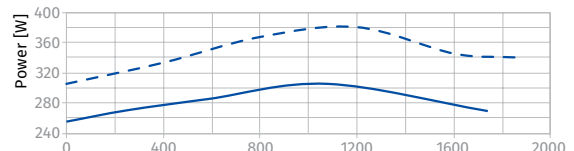
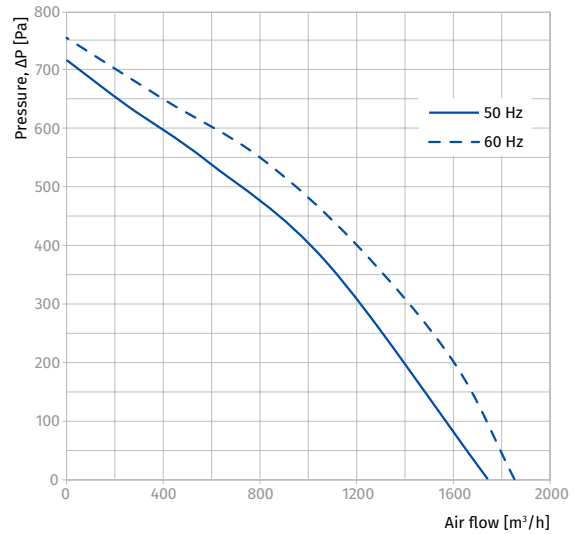
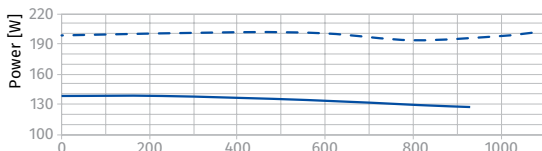
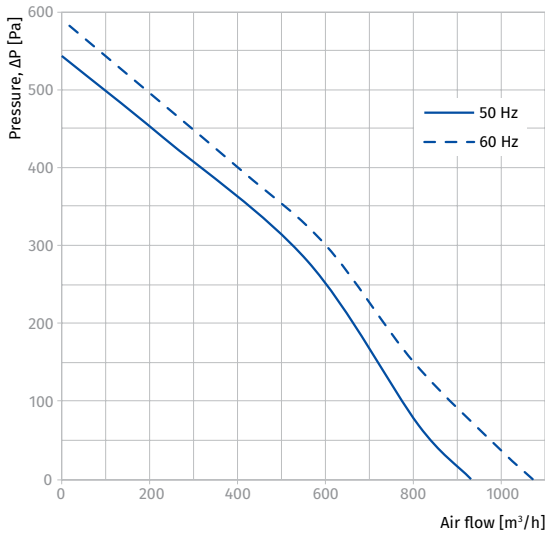

INLINE FANS FOR RECTANGULAR DUCTS

Parameters	Box 50x30 4E		Box 50x30 4D	
Voltage [V]	1 ~ 230		3 ~ 400	
Frequency [Hz]	50	60	50	60
Power [W]	140	175	136	165
Current [A]	0.57	0.73	0.34	0.53
Maximum air flow [m ³ /h (l/s)]	1700 (472)	1855 (515)	1380 (383)	1620 (450)
RPM [min ⁻¹]	1390	1530	1360	1600
Sound pressure at 3 m [dBA]	53	55	52	55
Transported air temperature [°C]	-25...+45	-25...+50	-25...+65	-25...+55
IP rating	IPX4		IPX4	
Motor IP rating	IP44		IP44	
ErP	2018		2018	

BOX 50x30 4E

Sound power level, A-weighted	Total	Octave frequency bands [Hz]								LpA 3 m	LpA 1 m
		63	125	250	500	1000	2000	4000	8000		
LWA to inlet [dBA]	81	62	70	73	64	77	75	70	64	60	70
LWA to outlet [dBA]	85	59	70	75	75	80	79	77	72	65	75
LWA to environment [dBA]	74	50	63	70	66	66	65	61	55	53	63

BOX 50x30 4D

Sound power level, A-weighted	Total	Octave frequency bands [Hz]								LpA 3 m	LpA 1 m
		63	125	250	500	1000	2000	4000	8000		
LWA to inlet [dBA]	80	61	69	72	63	75	74	69	63	59	69
LWA to outlet [dBA]	83	58	69	74	74	78	77	75	71	63	73
LWA to environment [dBA]	73	50	62	69	65	65	64	60	54	52	62

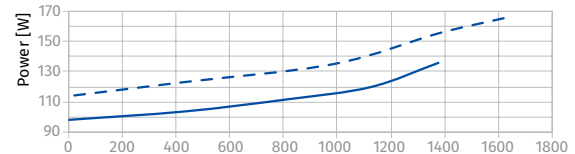
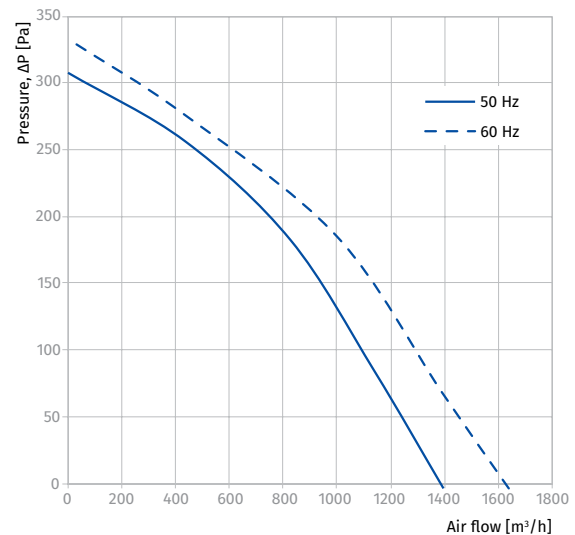
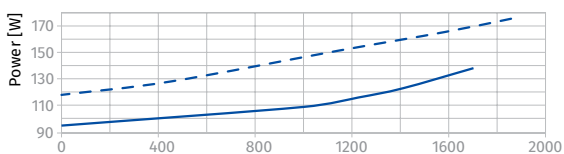
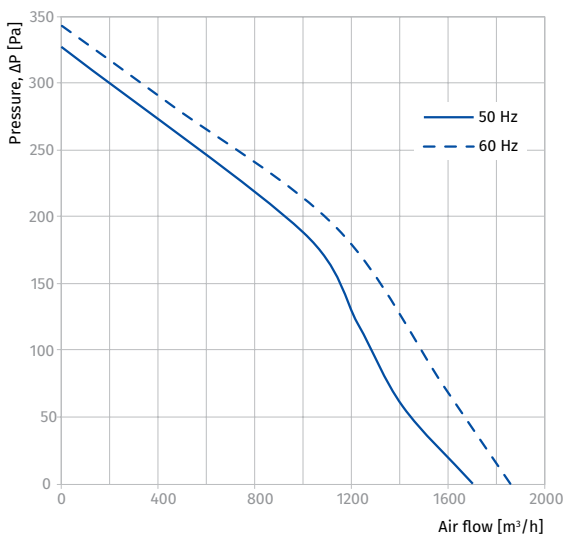

Parameters	Box 60x30 4E		Box 60x30 4D	
Voltage [V]	1 ~ 230		3 ~ 400	
Frequency [Hz]	50	60	50	60
Power [W]	220	310	230	235
Current [A]	0.9	1.38	0.52	0.53
Maximum air flow [m³/h (l/s)]	2470 (686)	2510 (697)	2530 (703)	2630 (731)
RPM [min⁻¹]	1400	1450	1360	1600
Sound pressure at 3 m [dBA]	52	52	51	53
Transported air temperature [°C]	-25...+45	-25...+40	-25...+70	-25...+65
IP rating	IPX4		IPX4	
Motor IP rating	IP44		IP44	
ErP	2018		2018	

BOX 60x30 4E

Sound power level, A-weighted	Total	Octave frequency bands [Hz]								LpA 3 m	LpA 1 m
		63	125	250	500	1000	2000	4000	8000		
LWA to inlet [dBA]	86	74	81	81	76	69	69	67	58	65	75
LWA to outlet [dBA]	89	76	81	84	83	79	79	78	69	69	79
LWA to environment [dBA]	73	47	60	68	67	68	58	53	42	52	62

BOX 60x30 4D

Sound power level, A-weighted	Total	Octave frequency bands [Hz]								LpA 3 m	LpA 1 m
		63	125	250	500	1000	2000	4000	8000		
LWA to inlet [dBA]	84	73	79	79	74	68	68	66	57	63	73
LWA to outlet [dBA]	88	74	79	82	81	77	77	76	68	67	77
LWA to environment [dBA]	72	47	59	67	66	67	57	52	42	51	61

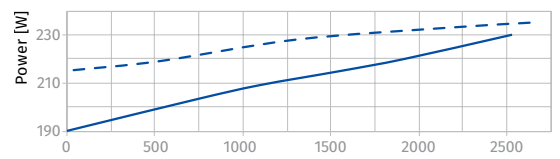
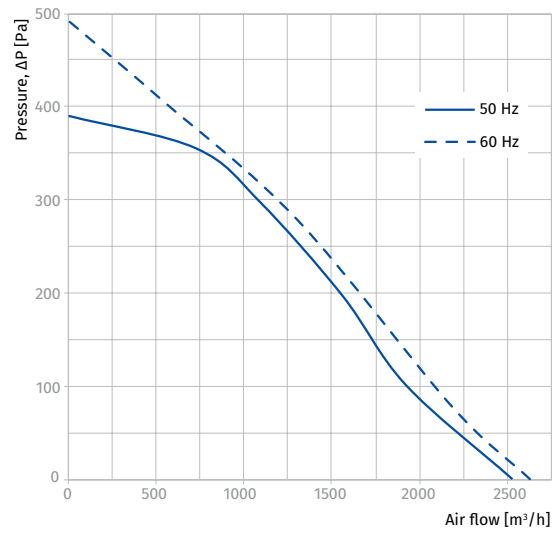
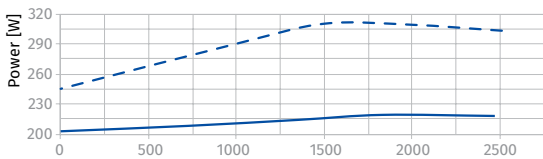
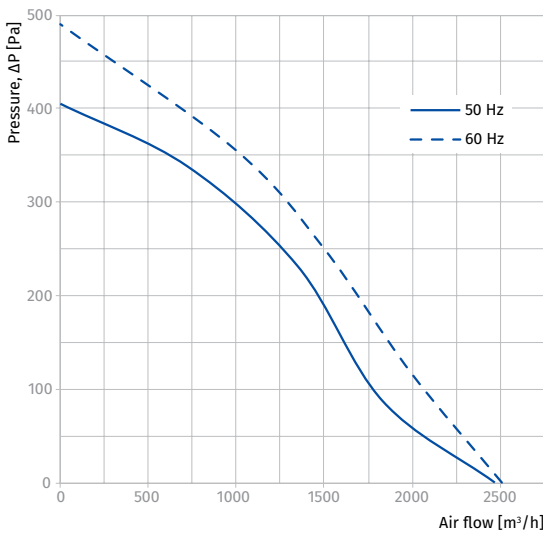

Parameters	Box 60x35 4E		Box 60x35 4D			
Voltage [V]	1 ~ 230		3 ~ 400 Δ		3 ~ 400 Y	
Frequency [Hz]	50	60	50	60	50	60
Power [W]	470	700	510	750	380	515
Current [A]	2.37	3.15	1.41	1.44	0.7	0.93
Maximum air flow [m³/h (l/s)]	2950 (820)	3515 (976)	2970 (825)	3410 (947)	2660 (739)	2730 (758)
RPM [min ⁻¹]	1370	1460	1415	1610	1235	1220
Sound pressure at 3 m [dBA]	52	53	51	53	50	50
Transported air temperature [°C]	-40...+80	-40...+55	-40...+60	-40...+60	-40...+80	-40...+40
IP rating	IPX4		IPX4		IPX4	
Motor IP rating	IP44		IP44		IP44	
ErP	2018		2018		2018	

BOX 60x35 4E

Sound power level, A-weighted	Total	Octave frequency bands [Hz]								LpA 3 m	LpA 1 m
		63	125	250	500	1000	2000	4000	8000		
LWA to inlet [dBA]	87	79	83	79	75	77	75	74	62	67	77
LWA to outlet [dBA]	90	78	78	79	81	85	83	81	68	69	79
LWA to environment [dBA]	72	44	59	65	68	67	61	58	50	52	62

BOX 60x35 4D

Sound power level, A-weighted	Total	Octave frequency bands [Hz]								LpA 3 m	LpA 1 m
		63	125	250	500	1000	2000	4000	8000		
LWA to inlet [dBA]	86	78	82	78	74	76	74	73	61	65	75
LWA to outlet [dBA]	88	77	77	78	79	83	82	79	67	68	78
LWA to environment [dBA]	72	43	58	65	67	66	61	57	50	51	61

INLINE FANS FOR RECTANGULAR DUCTS

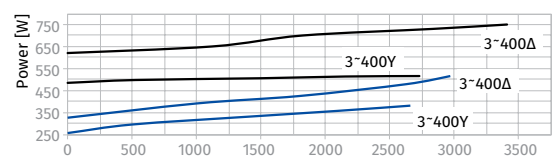
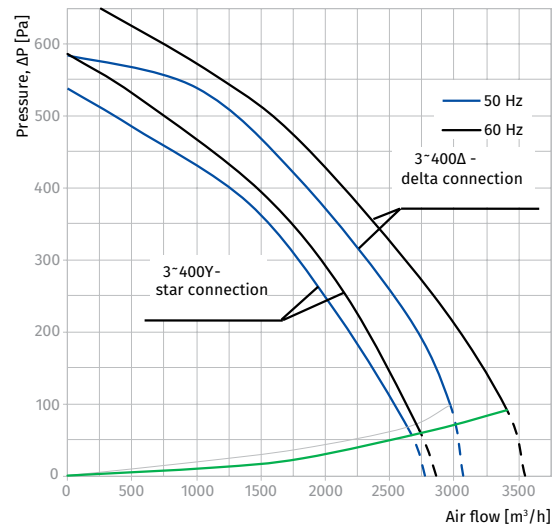
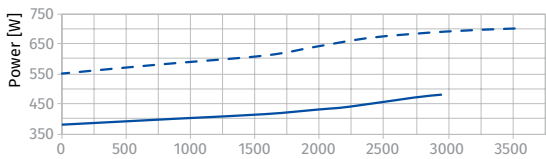
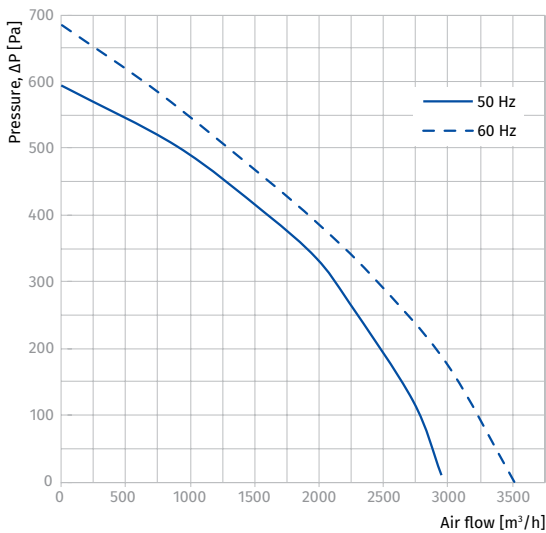

Parameters	Box 100x50 4D
Voltage [V]	3 ~ 400
Frequency [Hz]	50
Power [W]	3800
Current [A]	6.6
Maximum air flow [m³/h (l/s)]	15000 (4167)
RPM [min ⁻¹]	1360
Sound pressure at 3 m [dBA]	70
Transported air temperature [°C]	-20...+40
IP rating	IPX4
Motor IP rating	IP44
ErP	2018

BOX 100X50 4D

Sound power level, A-weighted	Total	Octave frequency bands [Hz]								LpA 3 m	LpA 1 m
		63	125	250	500	1000	2000	4000	8000		
L _{WA} to inlet [dBA]	99	92	96	92	87	89	87	86	72	79	89
L _{WA} to outlet [dBA]	98	86	86	87	89	93	92	89	74	77	87
L _{WA} to environment [dBA]	90	55	75	83	86	85	78	73	64	70	80

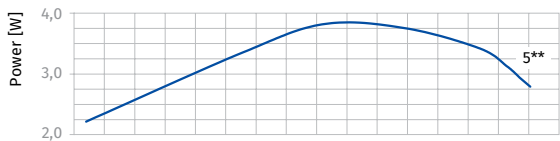
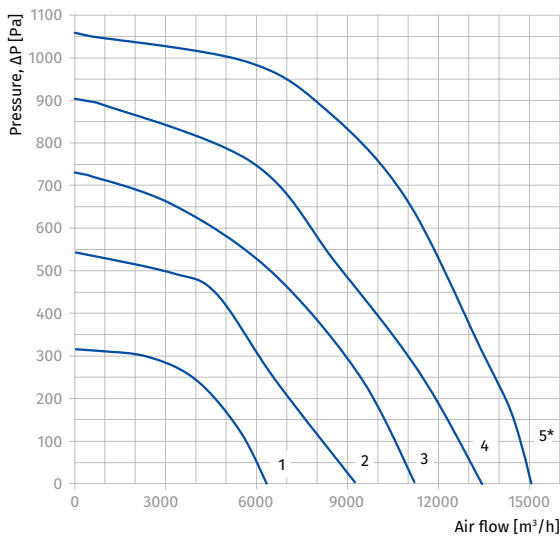

* performance characteristics for speed control with a five-step auto transformer
 ** power consumption curve for maximum air flow

Box EC

Centrifugal fans with EC motor for rectangular ducts

Use

- Supply and extract ventilation systems installed in commercial, office and other public or industrial premises.
- For arranging energy-saving and controllable ventilation systems.
- Compatible with 300x150 up to 1000x500 mm rectangular air ducts.



Air flow:
up to 11190 m³/h
3109 l/s



Power:
from 91 W



Noise level:
from 43 dBA



Design

- Atmospheric resistant galvanized steel casing.
- The fan is rated for continuous operation always connected to power mains.
- Fitted with standard 20 mm connecting flanges for connection to rectangular air ducts.
- Access cover on the casing for inspection and maintenance operations.

Motor

- High-efficient direct current EC motor with external rotor and backward curved blades.
- EC technology meets the up-to-date requirements to energy-saving and controllable ventilation and provides up to 35 % energy saving as compared to asynchronous motors.
- EC motor ensures totally controllable speed range for the fan and has integrated overheating protection with automatic restart.
- EC motor has no friction and wearing parts as capacitor and brushes. Instead a maintenance-free EC controller electronic circuit board is used.
- The impeller is dynamically balanced.
- The fan is compatible with 50 Hz and 60 Hz power mains and the maximum speed does not depend on power mains frequency.

Speed control

- The fan speed is controlled with a 0–10 V control signal from the following sources:
 - integrated or external speed controller
 - controller with sensors
 - central BMS system.
- The control signal value changes depending on air temperature, pressure, smoke concentration and other parameters.
- During signal value change the fan with EC motor correspondingly changes the rotations speed and delivers required air volume to the ventilation system.
- The computer central building management systems (BMS) enable integration of several EC motors in network and precise individual operation control for each fan.

Mounting

- The fan is designed for mounting inside rectangular air ducts and can be installed in any position.
- The fan flanges are connected to the air ducts through the bolts inserted into the flange holes.
- Suitable for mounting into round duct on intake flange with a round flange reducer (available upon separate order).
- If flexible vibration-absorbing connectors are used to connect the fan to the air ducts provide their fixation to mounting structures with supports or brackets.
- While mounting provide enough space for accessing the cover for service operations.

INLINE FANS FOR RECTANGULAR DUCTS

Designation key

Series	Motor type	Flange size (width x height) [cm]	Phase	Motor modifications
Box	EC: electronically commutated motor	30x15; 40x20; 50x25; 50x30; 60x30; 60x35; 70x40; 80x50; 90x50; 100x50	- 1: single-phase 3: three-phase	-: standard type max: high-powered motor

Accessories

Silencers	Filter boxes	Electric heaters	Water heaters	Air dampers	Gravity dampers	Flexible antivibration connectors	Speed controllers
							
SD	KFBK / KFBT	EKH	WKH	SL	VG	EVA	CDT E/0-10

Overall dimensions [mm]

Type	B	B1	B2	H	H1	H2	H3	L	Weight [kg]
Box EC 30x15-1	300	320	340	150	170	190	228	350	5.5
Box EC 30x15-1 max	300	320	340	150	170	190	228	350	6.0
Box EC 40x20-1	400	420	440	200	220	240	278	440	8.3
Box EC 40x20-1 max	400	420	440	200	220	240	278	440	10.0
Box EC 50x25-1	500	520	540	250	270	290	328	530	15.7
Box EC 50x25-1 max	500	520	540	250	270	290	328	530	17.9
Box EC 50x30-1 max	500	520	540	300	320	340	410	530	18.7
Box EC 60x30-1	600	620	640	300	320	340	407	650	24.1
Box EC 60x35-1	600	620	640	350	370	390	457	650	25.2
Box EC 60x35-3 max	600	620	640	350	370	390	512	650	36.0
Box EC 70x40-1	700	720	740	400	420	440	496	750	42.2
Box EC 70x40-3 max	700	720	740	400	420	440	555	750	43.0
Box EC 80x50-3	800	820	840	500	520	540	614	850	62.3
Box EC 80x50-3 max	800	820	840	500	520	540	670	850	54.3
Box EC 90x50-3 max	900	920	940	500	520	540	656	950	72.0
Box EC 100x50-3 max	1000	1020	1040	500	520	540	656	950	77.0

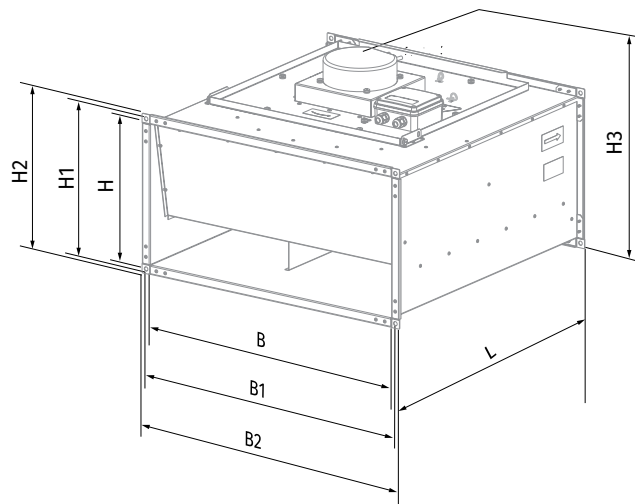

Parameters	Box EC 30x15-1	Box EC 30x15-1 max	Box EC 40x20-1	Box EC 40x20-1 max
Voltage [V / 50 (60) Hz]	1 ~ 230	1 ~ 230	1 ~ 230	1 ~ 230
Power [W]	97	101	91	192
Current [A]	0.73	0.80	0.69	1.43
Maximum air flow [m ³ /h (l/s)]	565 (157)	665 (185)	810 (225)	1190 (331)
RPM [min ⁻¹]	3300	3500	2470	3010
Sound pressure at 3 m [dBA]	44	46	43	47
Transported air temperature [°C]	-25...+50	-25...+50	-25...+50	-25...+50
SEC class	B	B	B	-
IP rating	IPX4	IPX4	IPX4	IPX4
Motor IP rating	IP55	IP54	IP55	IP54
ErP	2018	2018	2018	2018

BOX EC 30x15-1

Sound power level, A-weighted	Total	Octave frequency bands [Hz]								LpA 3 m	LpA 1 m
		63	125	250	500	1000	2000	4000	8000		
LWA to inlet [dBA]	75	53	63	69	72	63	62	63	55	54	64
LWA to outlet [dBA]	78	57	63	70	73	69	71	68	60	57	67
LWA to environment [dBA]	64	35	51	53	62	58	54	48	40	44	54

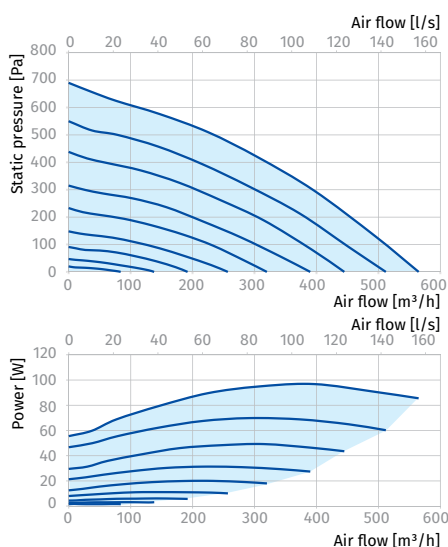
BOX EC 40x20-1

Sound power level, A-weighted	Total	Octave frequency bands [Hz]								LpA 3 m	LpA 1 m
		63	125	250	500	1000	2000	4000	8000		
LWA to inlet [dBA]	76	40	55	72	65	69	67	65	60	55	65
LWA to outlet [dBA]	78	37	52	70	71	69	73	68	61	57	67
LWA to environment [dBA]	63	39	47	61	57	52	51	46	39	43	53

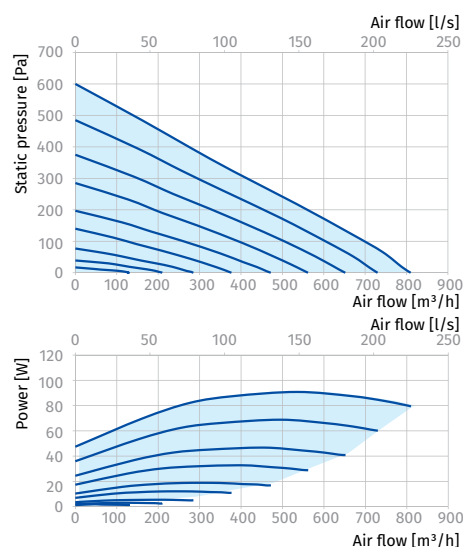
BOX EC 30x15-1 MAX

Sound power level, A-weighted	Total	Octave frequency bands [Hz]								LpA 3 m	LpA 1 m
		63	125	250	500	1000	2000	4000	8000		
LWA to inlet [dBA]	76	54	64	70	73	64	63	64	56	56	66
LWA to outlet [dBA]	80	59	65	73	75	72	74	71	62	60	70
LWA to environment [dBA]	67	37	53	55	64	60	56	50	42	46	56

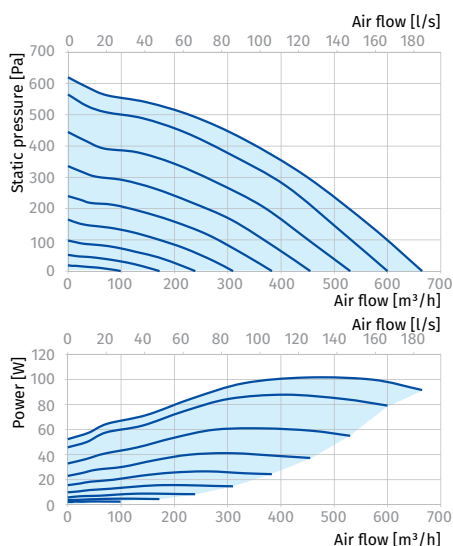
BOX EC 40x20-1 MAX

Sound power level, A-weighted	Total	Octave frequency bands [Hz]								LpA 3 m	LpA 1 m
		63	125	250	500	1000	2000	4000	8000		
LWA to inlet [dBA]	83	50	79	75	76	76	72	66	65	62	72
LWA to outlet [dBA]	82	47	75	74	76	77	69	63	60	61	71
LWA to environment [dBA]	68	48	65	61	58	58	51	44	40	47	57

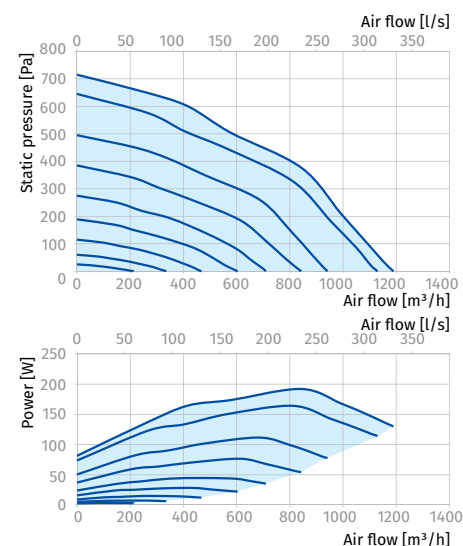

Parameters	Box EC 50x25-1	Box EC 50x25-1 max	Box EC 50x30-1 max	Box EC 60x30-1
Voltage [V/50 (60) Hz]	1 ~ 230	1 ~ 230	1 ~ 230	1 ~ 230
Power [W]	252	555	553	326
Current [A]	1.85	4.10	4.20	2.45
Maximum air flow [m³/h (l/s)]	1590 (442)	2480 (689)	2700 (750)	2545 (707)
RPM [min ⁻¹]	2500	3100	3100	2000
Sound pressure at 3 m [dBA]	45	51	51	48
Transported air temperature [°C]	-25...+50	-25...+50	-25...+50	-25...+50
SEC class	-	-	-	-
IP rating	IPX4	IPX4	IPX4	IPX4
Motor IP rating	IP54	IP54	IP54	IP54
ErP	2018	2018	2018	2018

BOX EC 50x25-1

Sound power level, A-weighted	Total	Octave frequency bands [Hz]								LpA 3 m	LpA 1 m
		63	125	250	500	1000	2000	4000	8000		
L _{WA} to inlet [dBA]	78	41	57	75	67	71	69	67	62	57	67
L _{WA} to outlet [dBA]	80	38	54	72	73	71	75	70	63	59	69
L _{WA} to environment [dBA]	65	40	48	63	59	54	53	47	40	45	55

BOX EC 50x30-1 MAX

Sound power level, A-weighted	Total	Octave frequency bands [Hz]								LpA 3 m	LpA 1 m
		63	125	250	500	1000	2000	4000	8000		
L _{WA} to inlet [dBA]	85	50	80	78	78	78	75	69	67	65	75
L _{WA} to outlet [dBA]	85	48	79	76	78	79	72	66	62	64	74
L _{WA} to environment [dBA]	72	49	70	65	60	60	54	46	40	51	61

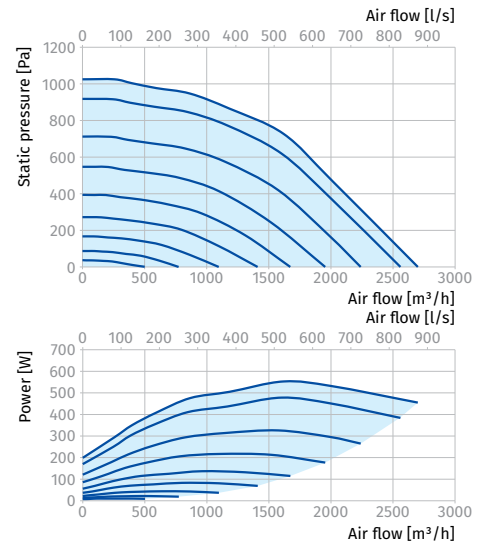
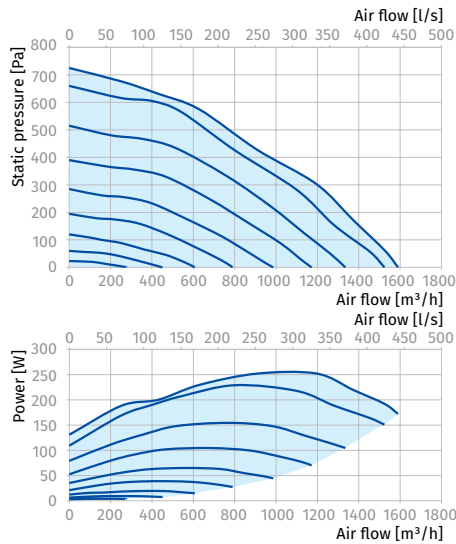

BOX EC 50x25-1 MAX

Sound power level, A-weighted	Total	Octave frequency bands [Hz]								LpA 3 m	LpA 1 m
		63	125	250	500	1000	2000	4000	8000		
L _{WA} to inlet [dBA]	86	53	82	78	79	79	75	69	68	66	76
L _{WA} to outlet [dBA]	85	48	78	77	79	80	72	66	63	64	74
L _{WA} to environment [dBA]	72	50	69	65	62	62	55	46	42	51	61

BOX EC 60x30-1

Sound power level, A-weighted	Total	Octave frequency bands [Hz]								LpA 3 m	LpA 1 m
		63	125	250	500	1000	2000	4000	8000		
L _{WA} to inlet [dBA]	80	42	58	77	69	73	71	69	64	60	70
L _{WA} to outlet [dBA]	83	40	56	76	77	75	79	73	66	63	73
L _{WA} to environment [dBA]	68	42	51	66	62	56	55	50	42	48	58

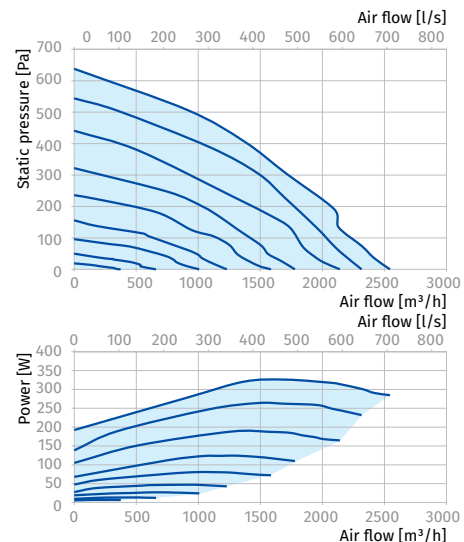
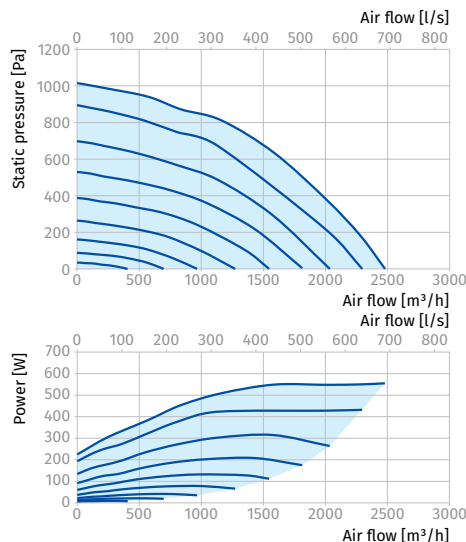

INLINE FANS FOR RECTANGULAR DUCTS

Parameters	Box EC 60x35-1	Box EC 60x35-3 max	Box EC 70x40-1	Box EC 70x40-3 max
Voltage [V/50 (60) Hz]	1 ~ 230	3 ~ 400	1 ~ 230	3 ~ 400
Power [W]	361	1308	795	2748
Current [A]	2.62	2.35	3.48	2.80
Maximum air flow [m ³ /h (l/s)]	2815 (782)	4290 (1192)	5710 (1586)	6810 (1892)
RPM [min ⁻¹]	2000	3160	1400	2530
Sound pressure at 3 m [dBA]	49	55	53	57
Transported air temperature [°C]	-25...+50	-25...+50	-25...+50	-25...+50
SEC class	-	-	-	-
IP rating	IPX4	IPX4	IPX4	IPX4
Motor IP rating	IP54	IP54	IP54	IP54
ErP	2018	2018	2018	2018

BOX EC 60x35-1

Sound power level, A-weighted	Total	Octave frequency bands [Hz]								LpA 3 m	LpA 1 m
		63	125	250	500	1000	2000	4000	8000		
LWA to inlet [dBA]	81	43	59	78	70	75	73	70	65	61	71
LWA to outlet [dBA]	85	41	57	77	78	76	80	75	67	64	74
LWA to environment [dBA]	69	43	52	67	63	57	56	50	43	49	59

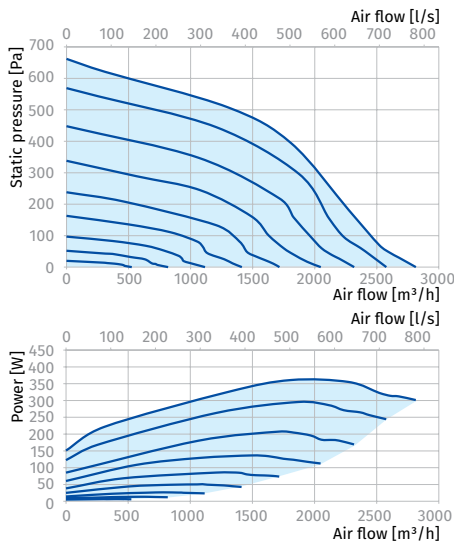
BOX EC 70x40-1

Sound power level, A-weighted	Total	Octave frequency bands [Hz]								LpA 3 m	LpA 1 m
		63	125	250	500	1000	2000	4000	8000		
LWA to inlet [dBA]	85	45	62	82	74	78	76	74	68	64	74
LWA to outlet [dBA]	88	43	60	81	82	79	84	78	70	68	78
LWA to environment [dBA]	74	46	55	72	67	61	60	54	46	53	63

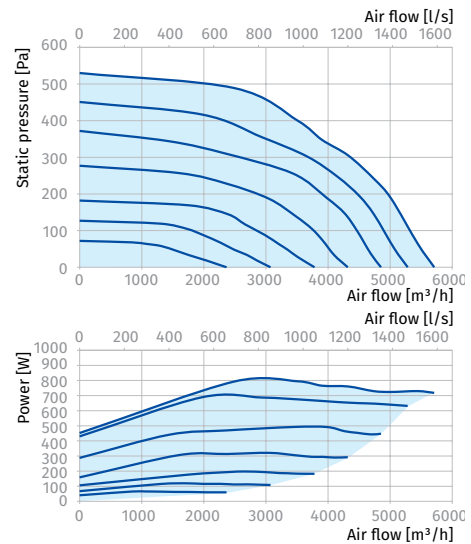
BOX EC 60x35-3 MAX

Sound power level, A-weighted	Total	Octave frequency bands [Hz]								LpA 3 m	LpA 1 m
		63	125	250	500	1000	2000	4000	8000		
LWA to inlet [dBA]	89	53	84	82	82	82	79	72	70	69	79
LWA to outlet [dBA]	88	50	83	80	82	83	76	69	65	68	78
LWA to environment [dBA]	76	52	74	68	63	63	57	49	43	55	65

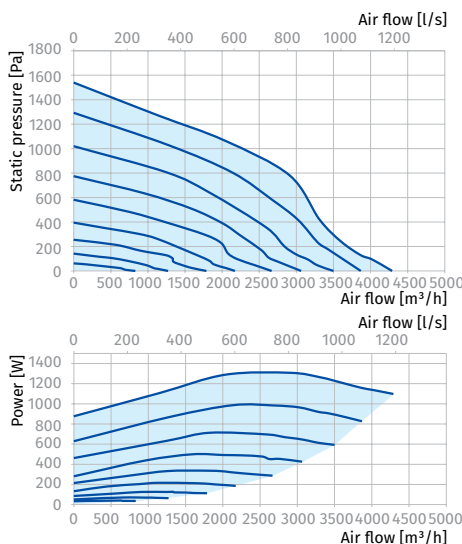
BOX EC 70x40-3 MAX

Sound power level, A-weighted	Total	Octave frequency bands [Hz]								LpA 3 m	LpA 1 m
		63	125	250	500	1000	2000	4000	8000		
LWA to inlet [dBA]	88	57	81	79	82	81	78	74	75	67	77
LWA to outlet [dBA]	92	56	82	85	85	86	81	75	75	71	81
LWA to environment [dBA]	77	55	75	71	67	65	60	55	52	57	67

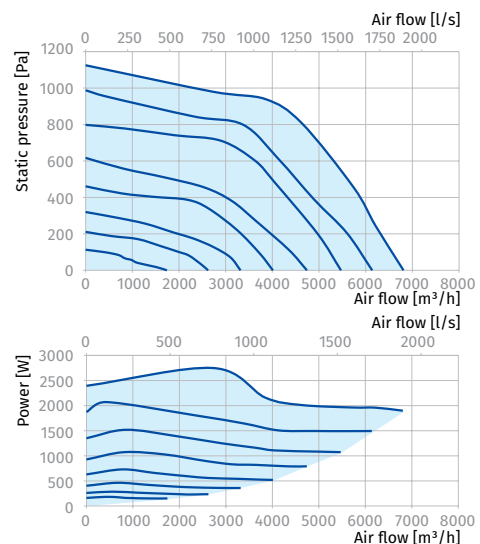

Parameters	Box EC 80x50-3	Box EC 80x50-3 max	Box EC 90x50-3 max	Box EC 100x50-3 max
Voltage [V/50 (60) Hz]	3 ~ 400	3 ~ 400	3 ~ 400	3 ~ 400
Power [W]	2025	2925	3429	3429
Current [A]	2.01	3.05	5.00	5.00
Maximum air flow [m³/h (l/s)]	8395 (2332)	8535 (2371)	11190 (3109)	11190 (3109)
RPM [min⁻¹]	1470	2400	1800	1800
Sound pressure at 3 m [dBA]	60	63	66	66
Transported air temperature [°C]	-25...+50	-25...+50	-25...+50	-25...+50
SEC class	-	-	-	-
IP rating	IPX4	IPX4	IPX4	IPX4
Motor IP rating	IP54	IP54	IP54	IP54
ErP	2018	2018	2018	2018

BOX EC 80x50-3

Sound power level, A-weighted	Total	Octave frequency bands [Hz]								LpA 3 m	LpA 1 m
		63	125	250	500	1000	2000	4000	8000		
L _{WA} to inlet [dBA]	89	47	65	86	77	82	80	77	71	68	78
L _{WA} to outlet [dBA]	92	44	62	84	85	83	88	82	73	71	81
L _{WA} to environment [dBA]	81	50	61	79	74	67	66	59	50	60	70

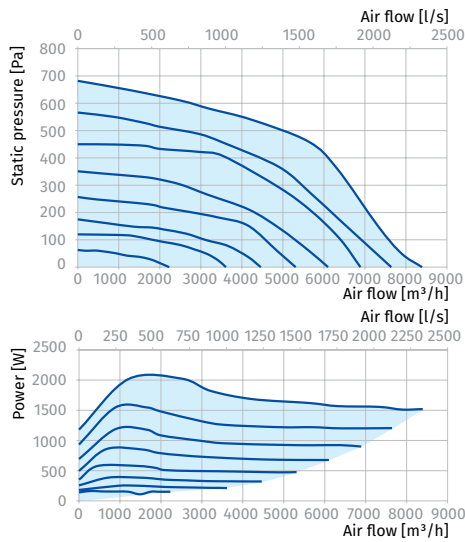

BOX EC 90x50-3 MAX, BOX EC 100x50-3 MAX

Sound power level, A-weighted	Total	Octave frequency bands [Hz]								LpA 3 m	LpA 1 m
		63	125	250	500	1000	2000	4000	8000		
L _{WA} to inlet [dBA]	92	60	85	83	87	85	82	78	79	71	81
L _{WA} to outlet [dBA]	94	58	85	88	88	89	84	77	77	74	84
L _{WA} to environment [dBA]	86	62	84	80	75	73	67	62	58	66	76

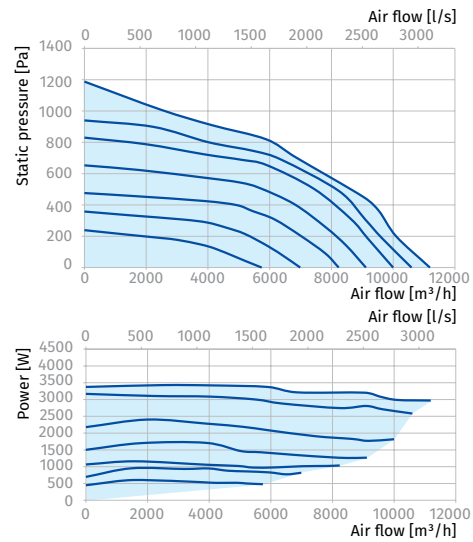

BOX EC 80x50-3 MAX

Sound power level, A-weighted	Total	Octave frequency bands [Hz]								LpA 3 m	LpA 1 m
		63	125	250	500	1000	2000	4000	8000		
L _{WA} to inlet [dBA]	90	59	83	81	85	83	80	76	77	70	80
L _{WA} to outlet [dBA]	93	57	84	87	87	88	83	76	76	73	83
L _{WA} to environment [dBA]	83	59	81	77	72	70	65	59	56	63	73

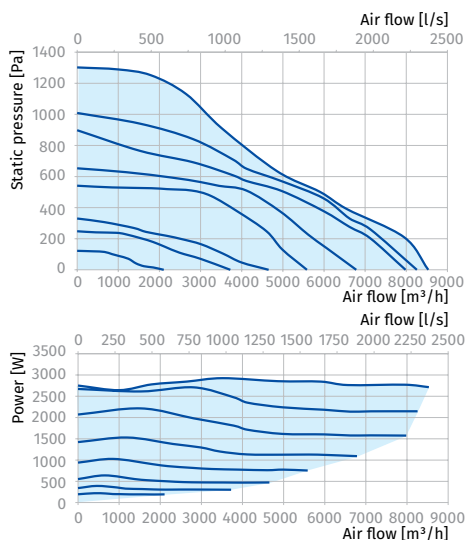

Box-I

Centrifugal fans in sound-insulated casing for rectangular ducts

Use

- Supply and exhaust ventilation systems installed in various premises.
- Compatible with 400x200 up to 600x350 mm rectangular air ducts.



Air flow:
up to 3515 m³/h
976 l/s



Power:
from 136 W



Noise level:
from 45 dBA



Design

- Atmospheric resistant galvanized steel casing and impeller.
- The casing is heat- and sound-insulated with 50 mm mineral wool.
- The fan is rated for continuous operation.
- Fitted with standard 20 mm connecting flanges for connection to rectangular air ducts.
- Access cover on the casing for inspection and maintenance operations.
- The fan is equipped with a built-in terminal box with a leaded outside sealed electrical lead-in for connection to power mains.

Motor

- Two- or four-pole asynchronous motor with external rotor and centrifugal impeller with backward curved blades.
- Single-phase (**E**) or three-phase (**D**) motor modifications.
- Equipped with ball bearings for longer service life.
- Dynamically balanced impeller.
- Overheating protection by built-in thermal switches with automatic restart or with leaded outside terminals for connection to external protecting controls.
- The thermal switch terminal leads are designed for connection to respective circuit of the contactor, overload relay or respective terminals of the autotransformer or thyristor speed controller.

Speed control

- Smooth speed control with an external thyristor controller or step speed control with an external auto transformer (both available upon separate order).

Mounting

- The fan is designed for mounting inside rectangular air ducts and can be installed in any position.
- The fan flanges are connected to the air ducts through the bolts inserted into the flange holes.
- The fan is suitable for mounting into round duct at intake flange with a round reducer (available upon separate order).
- If vibration-absorbing flexible connectors are used to connect the fan to the air ducts provide their fixation to mounting structures with supports or brackets.
- While mounting provide enough space for accessing the cover for service operations.

INLINE FANS FOR RECTANGULAR DUCTS

Designation key

Series	Flange size (width x height) [cm]	Motor Number of poles	Phase
Box-I	40x20; 50x25; 50x30; 60x30; 60x35	2; 4	E: single-phase D: three-phase

Accessories

Silencers	Filter boxes	Electric heaters	Water heaters	Air dampers	Gravity dampers	Flexible antivibration connectors	Speed controllers
							
SD	KFBK / KFBT	EKH	WKH	SL	VG	EVA	CDTE 1.8

Overall dimensions [mm]

Type	B	B1	B2	B3	H	H1	H2	H3	L	Weight [kg]
Box-I 40x20 2E	400	420	440	500	200	220	240	360	500	24.5
Box-I 50x25 2E	500	520	540	600	250	270	290	410	640	27.6
Box-I 50x30 4E	500	520	540	600	300	320	340	460	680	37.2
Box-I 50x30 4D	500	520	540	600	300	320	340	460	680	37.2
Box-I 60x30 4E	600	620	640	700	300	320	340	460	680	43.5
Box-I 60x30 4D	600	620	640	700	300	320	340	460	680	43.5
Box-I 60x35 4E	600	620	640	700	350	370	390	530	735	56.2
Box-I 60x35 4D	600	620	640	700	350	370	390	530	735	56.2

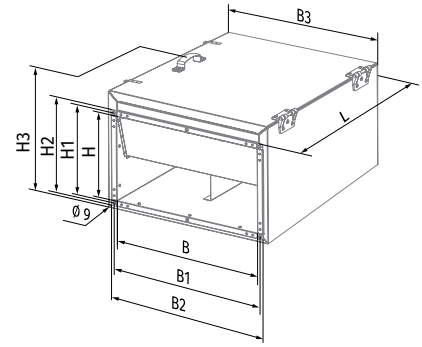

Technical data

Parameters	Box-I 40x20 2E	Box-I 50x25 2E
Voltage [V]	1 ~ 230	1 ~ 230
Frequency [Hz]	50	60
Power [W]	138	305
Current [A]	0.6	1.32
Maximum air flow [m³/h (l/s)]	930 (258)	1720 (478)
RPM [min⁻¹]	2600	2550
Sound pressure at 3 m [dBA]	45	51
Transported air temperature [°C]	-25...+45	-25...+45
IP rating	IPX4	IPX4
Motor IP rating	IP44	IP44
ErP	2018	2018

BOX-I 40x20 2E

Sound power level, A-weighted	Total	Octave frequency bands [Hz]								LpA 3 m	LpA 1 m
		63	125	250	500	1000	2000	4000	8000		
LWA to inlet [dBA]	75	64	70	70	66	61	61	58	51	54	64
LWA to outlet [dBA]	79	66	70	73	72	69	69	68	61	58	68
LWA to environment [dBA]	66	42	54	61	60	61	51	47	37	45	55

BOX-I 50x25 2E

Sound power level, A-weighted	Total	Octave frequency bands [Hz]								LpA 3 m	LpA 1 m
		63	125	250	500	1000	2000	4000	8000		
LWA to inlet [dBA]	75	62	69	71	60	63	67	64	59	55	65
LWA to outlet [dBA]	79	63	68	71	70	74	71	71	65	59	69
LWA to environment [dBA]	72	40	55	67	67	64	59	53	44	51	61

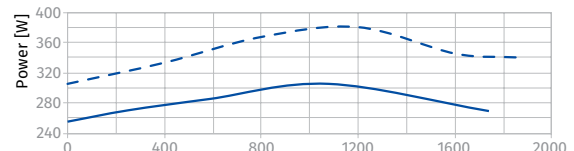
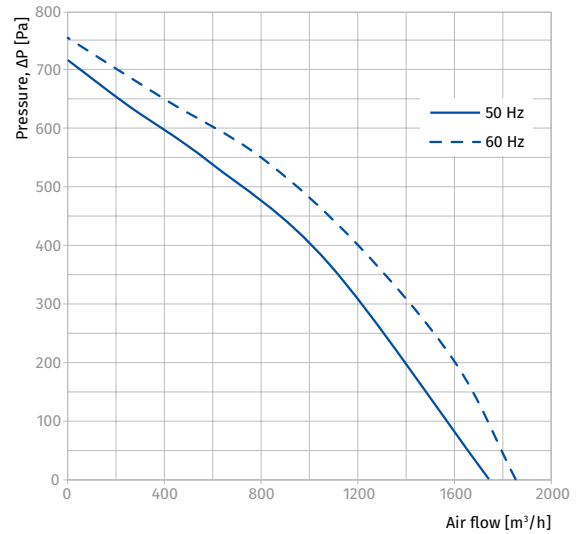
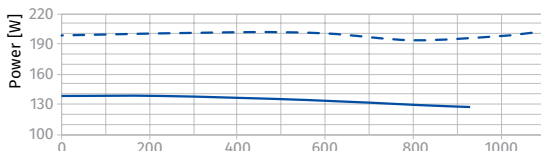
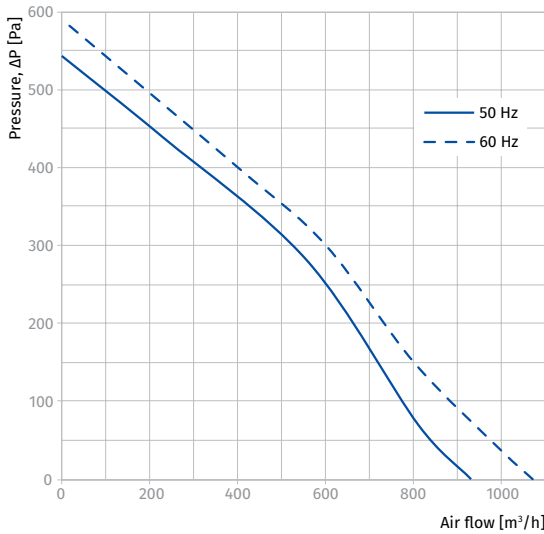

INLINE FANS FOR RECTANGULAR DUCTS

Parameters	Box-I 50x30 4E		Box-I 50x30 4D	
Voltage [V]	1 ~ 230		3 ~ 400	
Frequency [Hz]	50	60	50	60
Power [W]	140	175	136	165
Current [A]	0.57	0.73	0.34	0.53
Maximum air flow [m ³ /h (l/s)]	1700 (472)	1855 (515)	1380 (383)	1620 (450)
RPM [min ⁻¹]	1390	1530	1360	1600
Sound pressure at 3 m [dBA]	48	50	47	50
Transported air temperature [°C]	-25...+45	-25...+50	-25...+65	-25...+55
IP rating	IPX4		IPX4	
Motor IP rating	IP44		IP44	
ErP	2018		2018	

BOX-I 50x30 4E

Sound power level, A-weighted	Total	Octave frequency bands [Hz]								LpA 3 m	LpA 1 m
		63	125	250	500	1000	2000	4000	8000		
L _{WA} to inlet [dBA]	78	60	68	70	62	74	72	68	62	58	68
L _{WA} to outlet [dBA]	83	57	68	72	72	77	77	75	70	62	72
L _{WA} to environment [dBA]	69	46	58	64	61	61	60	56	51	48	58

BOX-I 50x30 4D

Sound power level, A-weighted	Total	Octave frequency bands [Hz]								LpA 3 m	LpA 1 m
		63	125	250	500	1000	2000	4000	8000		
L _{WA} to inlet [dBA]	77	59	67	69	61	73	71	67	61	56	66
L _{WA} to outlet [dBA]	81	56	67	71	71	75	75	74	69	61	71
L _{WA} to environment [dBA]	68	46	57	63	60	60	59	55	50	47	57

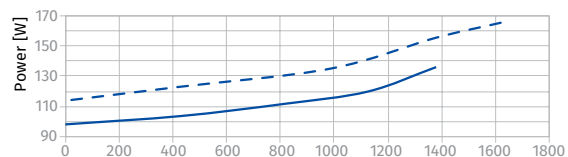
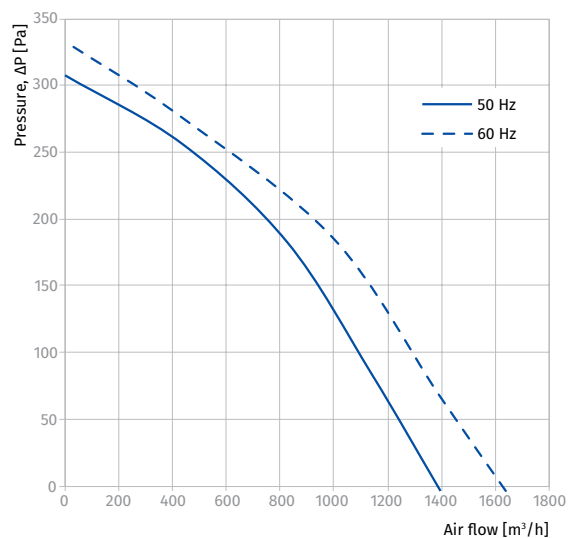
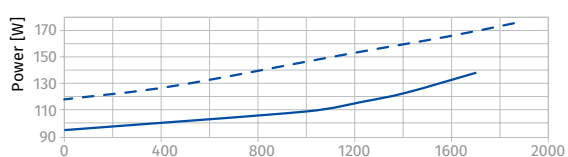
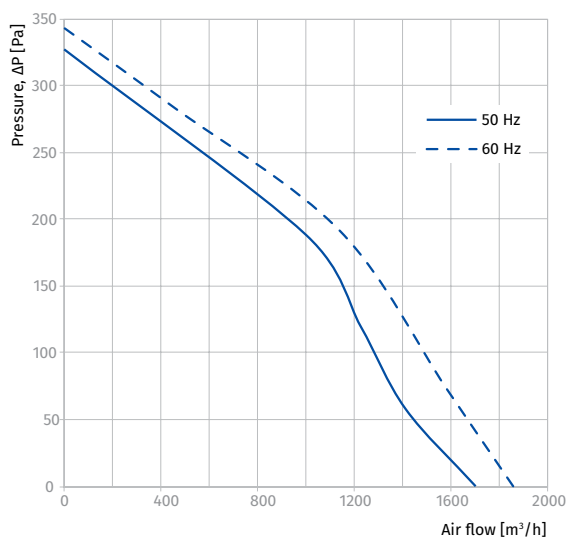

Parameters	Box-I 60x30 4E		Box-I 60x30 4D	
Voltage [V]	1 ~ 230		3 ~ 400	
Frequency [Hz]	50	60	50	60
Power [W]	220	310	230	235
Current [A]	0.9	1.38	0.52	0.53
Maximum air flow [m³/h (l/s)]	2470 (686)	2510 (697)	2530 (703)	2630 (731)
RPM [min ⁻¹]	1400	1450	1360	1600
Sound pressure at 3 m [dBA]	46	46	45	47
Transported air temperature [°C]	-25...+45	-25...+40	-25...+70	-25...+65
IP rating	IPX4		IPX4	
Motor IP rating	IP44		IP44	
ErP	2018		2018	

BOX-I 60x30 4E

Sound power level, A-weighted	Total	Octave frequency bands [Hz]								LpA 3 m	LpA 1 m
		63	125	250	500	1000	2000	4000	8000		
L _{WA} to inlet [dBA]	81	70	77	77	72	66	66	64	55	61	71
L _{WA} to outlet [dBA]	85	72	77	80	79	75	75	74	66	65	75
L _{WA} to environment [dBA]	67	43	55	62	61	62	53	48	38	46	56

BOX-I 60x30 4D

Sound power level, A-weighted	Total	Octave frequency bands [Hz]								LpA 3 m	LpA 1 m
		63	125	250	500	1000	2000	4000	8000		
L _{WA} to inlet [dBA]	80	69	75	75	71	65	65	63	54	59	69
L _{WA} to outlet [dBA]	84	71	75	78	77	74	74	73	65	63	73
L _{WA} to environment [dBA]	66	43	54	61	60	61	52	48	38	45	55

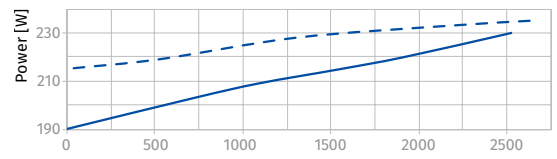
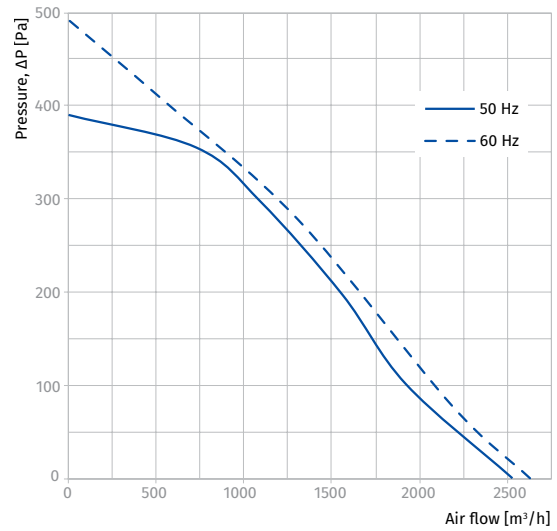
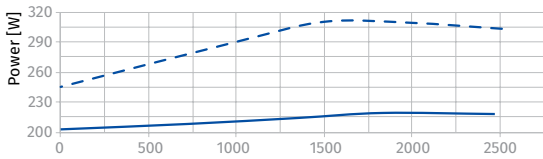
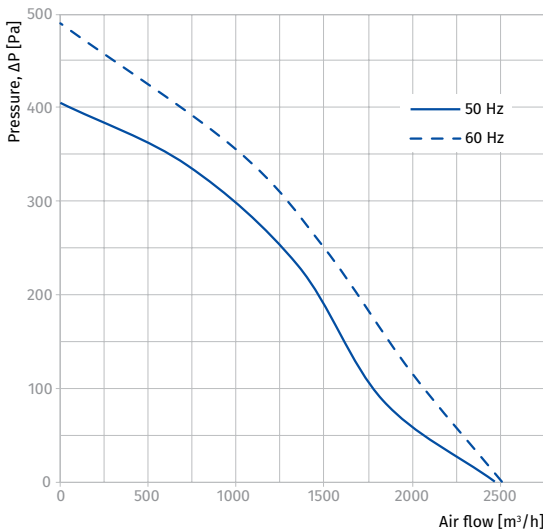

INLINE FANS FOR RECTANGULAR DUCTS

Parameters	Box-I 60x35 4E		Box-I 60x35 4D			
Voltage [V]	1 ~ 230		3 ~ 400 Δ		3 ~ 400 Y	
Frequency [Hz]	50	60	50	60	50	60
Power [W]	470	700	510	750	380	515
Current [A]	2.37	3.15	1.41	1.44	0.7	0.93
Maximum air flow [m³/h (l/s)]	2950 (820)	3515 (976)	2970 (825)	3410 (947)	2660 (739)	2730 (758)
RPM [min⁻¹]	1370	1460	1415	1610	1235	1220
Sound pressure at 3 m [dBA]	47	47	46	46	46	46
Transported air temperature [°C]	-40...+80	-40...+55	-40...+60	-40...+60	-40...+80	-40...+40
IP rating	IPX4		IPX4		IPX4	
Motor IP rating	IP44		IP44		IP44	
ErP	2018		2018		2018	

BOX-I 60x35 4E

Sound power level, A-weighted	Total	Octave frequency bands [Hz]								LpA 3 m	LpA 1 m
		63	125	250	500	1000	2000	4000	8000		
LWA to inlet [dBA]	81	73	77	73	70	71	70	68	58	61	71
LWA to outlet [dBA]	83	72	72	73	74	78	77	74	62	63	73
LWA to environment [dBA]	68	40	55	61	63	62	57	54	46	47	57

BOX-I 60x35 4D

Sound power level, A-weighted	Total	Octave frequency bands [Hz]								LpA 3 m	LpA 1 m
		63	125	250	500	1000	2000	4000	8000		
LWA to inlet [dBA]	80	73	76	73	69	70	69	68	57	60	70
LWA to outlet [dBA]	83	71	71	73	74	77	76	74	62	62	72
LWA to environment [dBA]	67	40	54	60	62	61	56	53	46	46	56

INLINE FANS FOR RECTANGULAR DUCTS

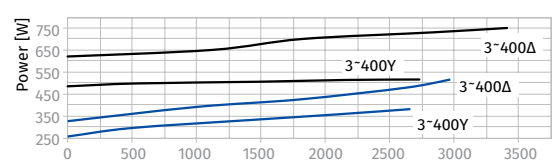
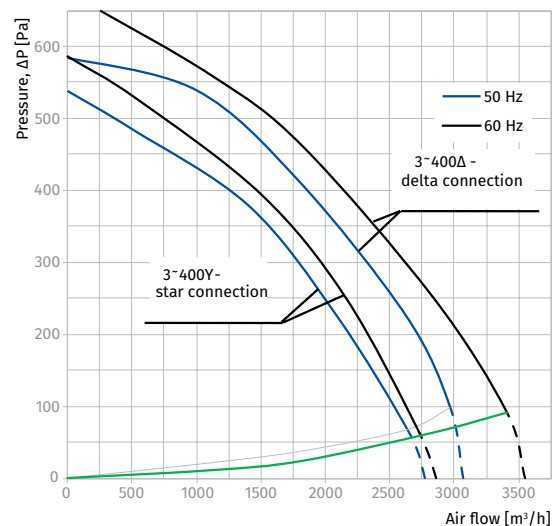
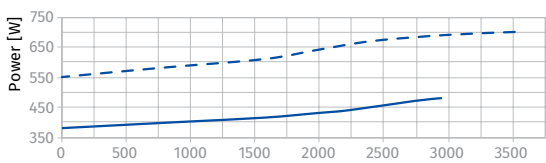
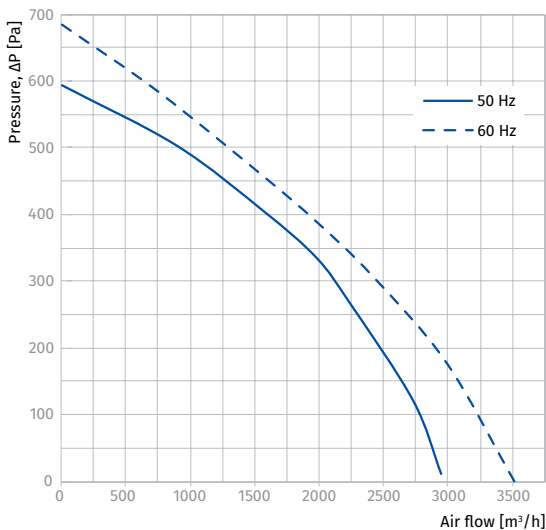

Box-I EC

Centrifugal fans in sound-insulated casing with EC motor

Use

- Supply and extract ventilation systems installed in various premises.
- For arranging energy-saving and controllable ventilation systems.
- Compatible with 300x150 up to 1000x500 mm rectangular air ducts.



Air flow:
up to 11190 m³/h
3109 l/s



Power:
from 91 W



Noise level:
from 29 dBA



Design

- Atmospheric resistant galvanized steel casing.
- The casing is heat- and sound-insulated with the mineral wool.
- The fan is rated for continuous operation always connected to power mains.
- Fitted with standard 20 mm connecting flanges for connection to rectangular air ducts.
- Access cover on the casing for inspection and maintenance operations.

Motor

- High-efficient direct current EC motor with external rotor and backward curved blades.
- EC technology meets the up-to-date requirements to energy-saving and controllable ventilation and provides up to 35 % energy saving as compared to asynchronous motors.
- EC motor ensures totally controllable speed range for the fan and has integrated overheating protection with automatic restart.
- EC motor has no friction and wearing parts as capacitor and brushes. Instead a maintenance-free EC controller electronic circuit board is used.
- The impeller is dynamically balanced.
- The fan is compatible with 50 Hz and 60 Hz power mains and the maximum speed does not depend on power mains frequency.

Speed control

- The fan speed is controlled with a 0-10 V control signal from the following sources:
 - integrated or external speed controller
 - controller with sensors
 - central BMS system.
- The control signal value changes depending on air temperature, pressure, smoke concentration and other parameters.
- During signal value change the fan with EC motor correspondingly changes the rotations speed and delivers required air volume to the ventilation system.
- The computer central building management systems (BMS) enable integration of several EC motors in network and precise individual operation control for each fan.

Mounting

- The fan is designed for mounting inside rectangular air ducts and can be installed in any position.
- The fan flanges are connected to the air ducts through the bolts inserted into the flange holes.
- Suitable for mounting into round duct on intake flange with a round flange reducer (available upon separate order).
- When connecting the fans to the air ducts through the flexible anti-vibration connectors, as well as for sizes 600x300 and above, the fan must be secured to a mounting surface with supports, hanger brackets or brackets.
- While mounting provide enough space for accessing the cover for service operations.

Designation key

Series	Motor type	Flange size (width x height) [cm]	Phase	Motor modifications
Box-I	EC: electronically commutated motor	30x15; 40x20; 50x25; 50x30; 60x30; 60x35; 70x40; 80x50; 90x50; 100x50	- 1: single-phase 3: three-phase	-: medium pressure motor max: high pressure motor

Accessories

Silencers	Filter boxes	Electric heaters	Water heaters	Air dampers	Gravity dampers	Flexible antivibration connectors	Speed controllers
							
SD	KFBK / KFBT	EKH	WKH	SL	VG	EVA	CDT E/0-10

Overall dimensions [mm]

Type	B	B1	H	H1	L	Weight [kg]
Box-I EC 30x15-1	364	300	271	150	370	10.3
Box-I EC 30x15-1 max	364	300	271	150	370	10.8
Box-I EC 40x20-1	464	400	322	200	460	15.1
Box-I EC 40x20-1 max	464	400	322	200	460	16.8
Box-I EC 50x25-1	564	500	373	250	560	25.5
Box-I EC 50x25-1 max	564	500	373	250	560	27.7
Box-I EC 50x30-1 max	564	500	424	300	560	29.0
Box-I EC 60x30-1	783	600	574	300	752	52.9
Box-I EC 60x35-1	783	600	664	350	752	56.6
Box-I EC 60x35-3 max	783	600	664	350	752	59.3
Box-I EC 70x40-1	883	700	714	400	882	82.6
Box-I EC 70x40-3 max	883	700	714	400	882	83.4
Box-I EC 80x50-3	983	800	814	500	937	108.4
Box-I EC 80x50-3 max	983	800	814	500	937	99.8
Box-I EC 90x50-3 max	1083	900	814	500	1052	120.0
Box-I EC 100x50-3 max	1183	1000	814	500	1052	130.0

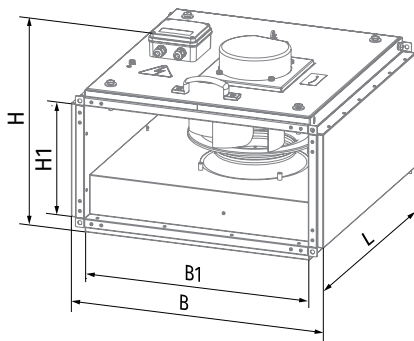

Box-I EC 30x15 - Box-I EC 60x30

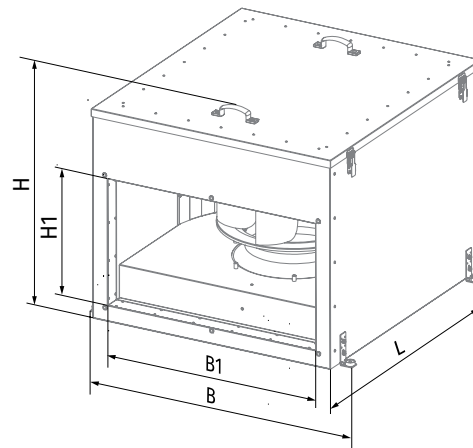

Box-I EC 60x35 - Box-I EC 100x50

Parameters	Box-I EC 30x15-1	Box-I EC 30x15-1 max	Box-I EC 40x20-1	Box-I EC 40x20-1 max
Voltage [V / 50 (60) Hz]	1 ~ 230	1 ~ 230	1 ~ 230	1 ~ 230
Power [W]	97	101	91	192
Current [A]	0.73	0.80	0.69	1.43
Maximum air flow [m³/h (l/s)]	565 (157)	665 (185)	810 (225)	1190 (331)
RPM [min ⁻¹]	3300	3500	2470	3010
Sound pressure at 3 m [dBA]	29	30	33	30
Transported air temperature [°C]	-25...+50	-25...+50	-25...+50	-25...+50
SEC class	B	B	B	-
IP rating	IPX4	IPX4	IPX4	IPX4
Motor IP rating	IP55	IP54	IP55	IP54
ErP	2018	2018	2018	2018

BOX-I EC 30x15-1

Sound power level, A-weighted	Total	Octave frequency bands [Hz]								LpA 3 m	LpA 1 m
		63	125	250	500	1000	2000	4000	8000		
LWA to inlet [dBA]	57	39	46	51	53	46	46	46	41	36	46
LWA to outlet [dBA]	61	44	48	54	56	53	54	52	46	41	51
LWA to environment [dBA]	50	27	38	40	46	43	40	36	30	29	39

BOX-I EC 40x20-1

Sound power level, A-weighted	Total	Octave frequency bands [Hz]								LpA 3 m	LpA 1 m
		63	125	250	500	1000	2000	4000	8000		
LWA to inlet [dBA]	63	33	45	59	54	57	55	54	49	43	53
LWA to outlet [dBA]	65	30	43	57	58	57	60	56	50	44	54
LWA to environment [dBA]	53	32	39	50	47	43	42	38	32	33	43

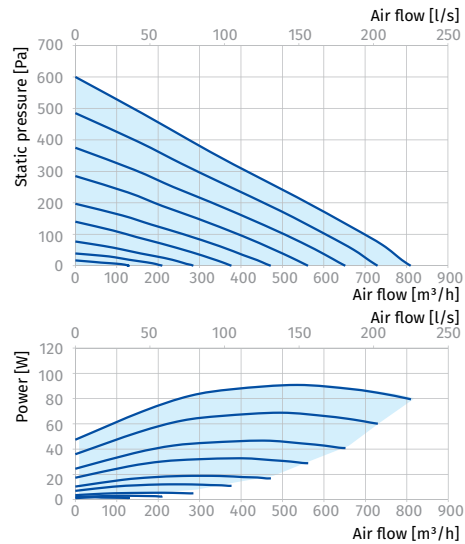
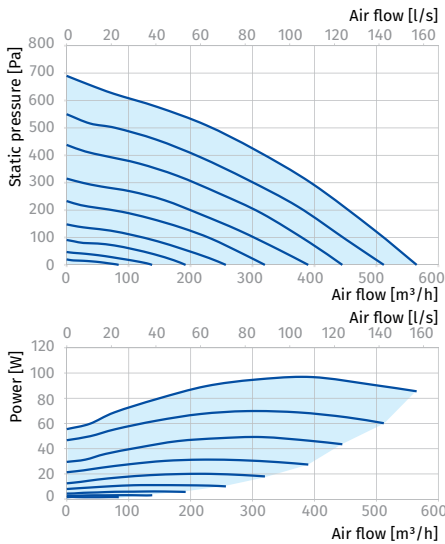

BOX-I EC 30x15-1 MAX

Sound power level, A-weighted	Total	Octave frequency bands [Hz]								LpA 3 m	LpA 1 m
		63	125	250	500	1000	2000	4000	8000		
LWA to inlet [dBA]	57	40	47	51	53	47	46	47	41	37	47
LWA to outlet [dBA]	62	44	49	54	57	54	55	53	46	42	52
LWA to environment [dBA]	51	27	39	40	47	44	41	37	31	30	40

BOX-I EC 40x20-1 MAX

Sound power level, A-weighted	Total	Octave frequency bands [Hz]								LpA 3 m	LpA 1 m
		63	125	250	500	1000	2000	4000	8000		
LWA to inlet [dBA]	62	36	57	54	54	54	52	47	47	41	51
LWA to outlet [dBA]	63	35	56	55	57	57	52	47	45	42	52
LWA to environment [dBA]	51	35	47	44	42	42	37	32	29	30	40

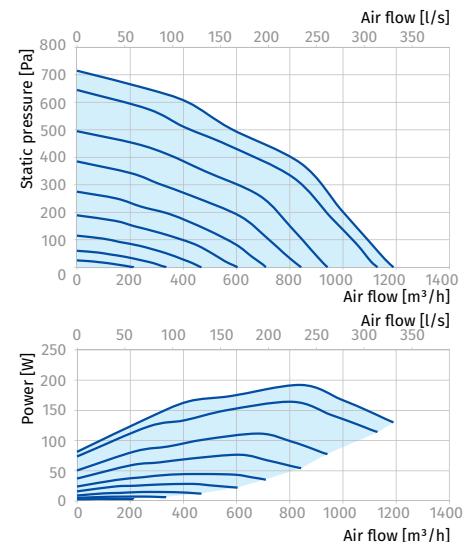
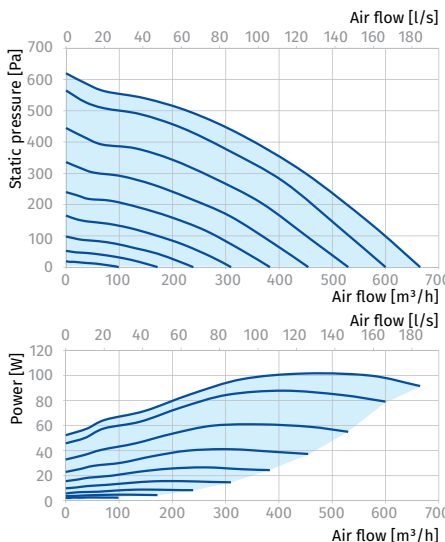

INLINE FANS FOR RECTANGULAR DUCTS

Parameters	Box-I EC 50x25-1	Box-I EC 50x25-1 max	Box-I EC 50x30-1 max	Box-I EC 60x30-1
Voltage [V/50 (60) Hz]	1 ~ 230	1 ~ 230	1 ~ 230	1 ~ 230
Power [W]	252	555	553	326
Current [A]	1.85	4.10	4.20	2.45
Maximum air flow [m³/h (l/s)]	1590 (442)	2480 (689)	2700 (750)	2545 (707)
RPM [min⁻¹]	2500	3100	3100	2000
Sound pressure at 3 m [dBA]	34	51	43	34
Transported air temperature [°C]	-25...+50	-25...+50	-25...+50	-25...+50
SEC class	-	-	-	-
IP rating	IPX4	IPX4	IPX4	IPX4
Motor IP rating	IP54	IP54	IP54	IP54
ErP	2018	2018	2018	2018

BOX-I EC 50x25-1

Sound power level, A-weighted	Total	Octave frequency bands [Hz]								LpA 3 m	LpA 1 m
		63	125	250	500	1000	2000	4000	8000		
L _{WA} to inlet [dBA]	64	38	59	56	57	57	54	49	49	44	54
L _{WA} to outlet [dBA]	64	35	57	56	58	58	52	48	46	43	53
L _{WA} to environment [dBA]	54	37	51	48	45	45	40	34	31	34	44

BOX-I EC 50x30-1 MAX

Sound power level, A-weighted	Total	Octave frequency bands [Hz]								LpA 3 m	LpA 1 m
		63	125	250	500	1000	2000	4000	8000		
L _{WA} to inlet [dBA]	75	45	70	67	68	68	64	59	58	54	64
L _{WA} to outlet [dBA]	75	42	68	67	69	69	62	57	54	54	64
L _{WA} to environment [dBA]	64	44	61	57	55	55	48	40	37	43	53

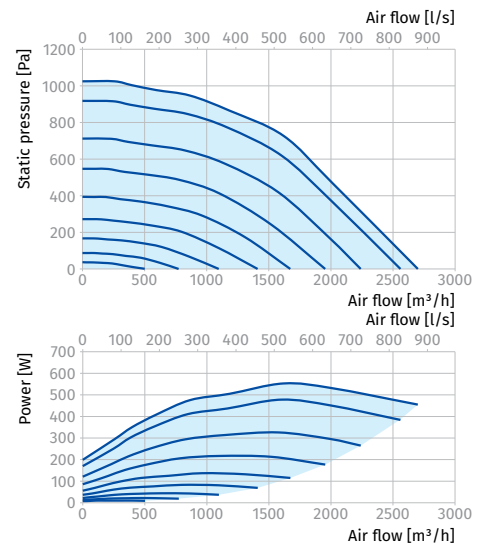
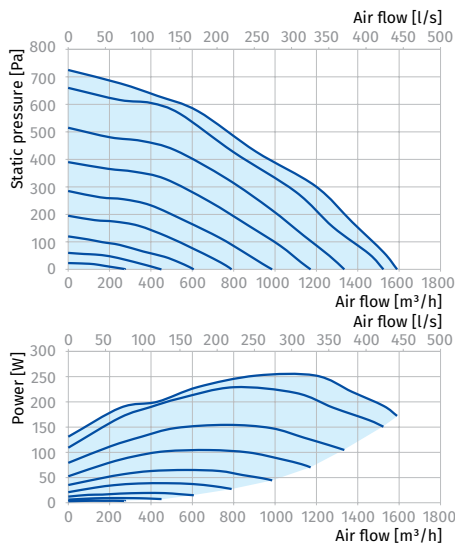

BOX-I EC 50x25-1 MAX

Sound power level, A-weighted	Total	Octave frequency bands [Hz]								LpA 3 m	LpA 1 m
		63	125	250	500	1000	2000	4000	8000		
L _{WA} to inlet [dBA]	74	45	70	66	67	67	64	58	58	54	64
L _{WA} to outlet [dBA]	72	41	65	64	66	67	60	55	53	52	62
L _{WA} to environment [dBA]	62	43	59	55	53	53	47	39	36	41	51

BOX-I EC 60x30-1

Sound power level, A-weighted	Total	Octave frequency bands [Hz]								LpA 3 m	LpA 1 m
		63	125	250	500	1000	2000	4000	8000		
L _{WA} to inlet [dBA]	63	32	45	59	53	57	55	53	49	43	53
L _{WA} to outlet [dBA]	64	30	42	57	58	56	59	55	49	44	54
L _{WA} to environment [dBA]	54	33	40	51	48	44	43	39	33	34	44

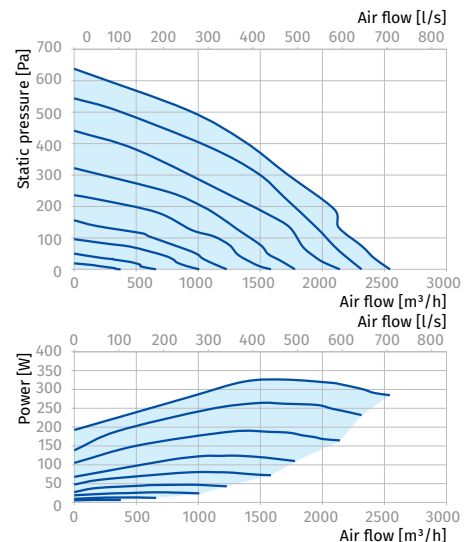
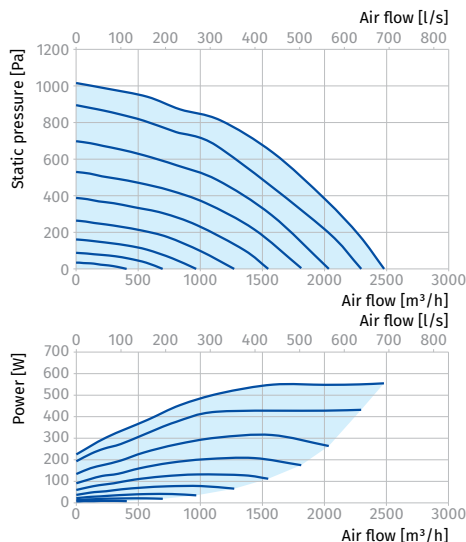

INLINE FANS FOR RECTANGULAR DUCTS

Parameters	Box-I EC 60x35-1	Box-I EC 60x35-3 max	Box-I EC 70x40-1	Box-I EC 70x40-3 max
Voltage [V/50 (60) Hz]	1 ~ 230	3 ~ 400	1 ~ 230	3 ~ 400
Power [W]	361	1308	795	2748
Current [A]	2.62	2.35	3.48	2.80
Maximum air flow [m³/h (l/s)]	2815 (782)	4290 (1192)	5710 (1586)	6810 (1892)
RPM [min ⁻¹]	2000	3160	1400	2530
Sound pressure at 3 m [dBA]	38	40	37	43
Transported air temperature [°C]	-25...+50	-25...+50	-25...+50	-25...+50
SEC class	-	-	-	-
IP rating	IPX4	IPX4	IPX4	IPX4
Motor IP rating	IP54	IP54	IP54	IP54
ErP	2018	2018	2018	2018

BOX-I EC 60x35-1

Sound power level, A-weighted	Total	Octave frequency bands [Hz]								LpA 3 m	LpA 1 m
		63	125	250	500	1000	2000	4000	8000		
LWA to inlet [dBA]	69	36	49	65	58	62	60	58	54	48	58
LWA to outlet [dBA]	76	36	50	68	69	67	71	66	59	55	65
LWA to environment [dBA]	59	36	44	56	53	48	47	42	36	38	48

BOX-I EC 70x40-1

Sound power level, A-weighted	Total	Octave frequency bands [Hz]								LpA 3 m	LpA 1 m
		63	125	250	500	1000	2000	4000	8000		
LWA to inlet [dBA]	66	38	60	59	59	59	57	52	51	46	56
LWA to outlet [dBA]	69	38	63	61	62	63	57	53	49	48	58
LWA to environment [dBA]	57	38	55	50	47	47	42	36	32	37	47

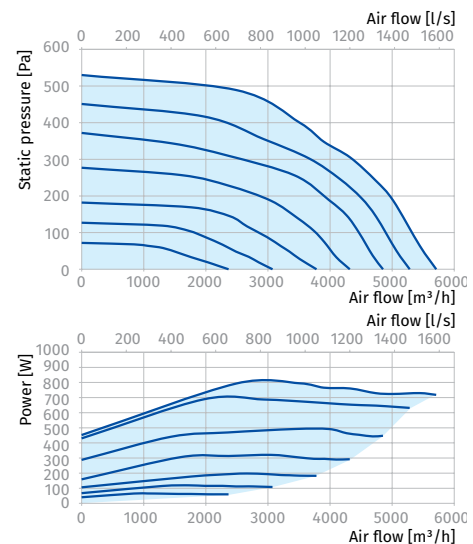
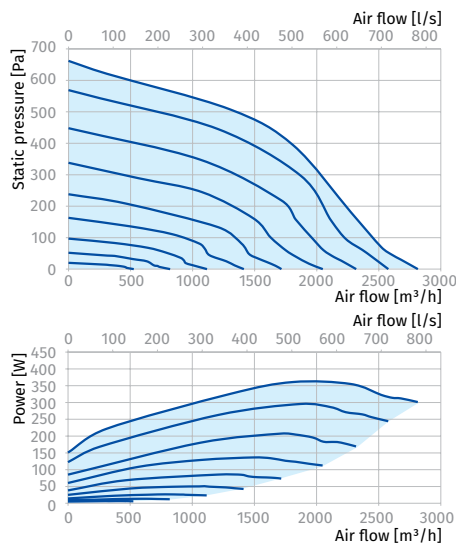

BOX-I EC 60x35-3 MAX

Sound power level, A-weighted	Total	Octave frequency bands [Hz]								LpA 3 m	LpA 1 m
		63	125	250	500	1000	2000	4000	8000		
LWA to inlet [dBA]	72	41	66	64	64	64	62	56	55	51	61
LWA to outlet [dBA]	70	39	64	62	64	64	59	54	51	50	60
LWA to environment [dBA]	60	40	58	53	49	49	45	38	33	40	50

BOX-I EC 70x40-3 MAX

Sound power level, A-weighted	Total	Octave frequency bands [Hz]								LpA 3 m	LpA 1 m
		63	125	250	500	1000	2000	4000	8000		
LWA to inlet [dBA]	72	46	64	63	66	64	62	59	60	51	61
LWA to outlet [dBA]	73	44	64	67	67	67	64	58	58	53	63
LWA to environment [dBA]	63	44	60	57	54	52	48	44	42	43	53

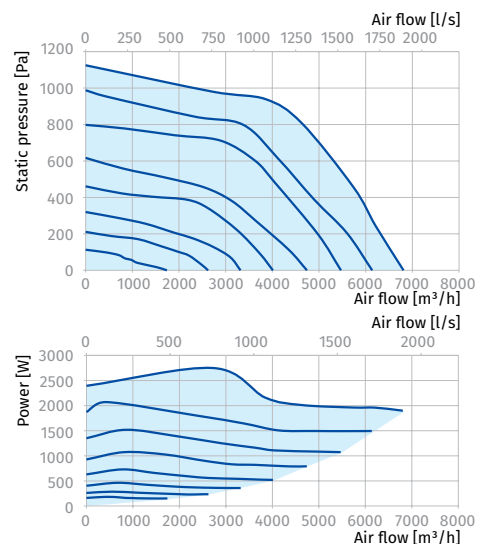
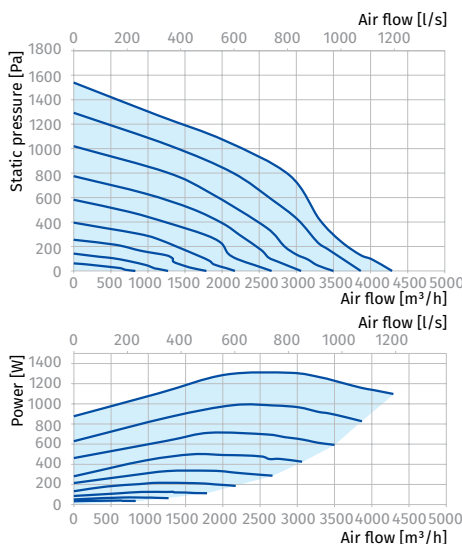

Parameters	Box-I EC 80x50-3	Box-I EC 80x50-3 max	Box-I EC 90x50-3 max	Box-I EC 100x50-3 max
Voltage [V/50 (60) Hz]	3 ~ 400	3 ~ 400	3 ~ 400	3 ~ 400
Power [W]	2025	2925	3429	3429
Current [A]	2.01	3.05	5.00	5.00
Maximum air flow [m³/h (l/s)]	8395 (2332)	8535 (2371)	11190 (3109)	11190 (3109)
RPM [min⁻¹]	1470	2400	1800	1800
Sound pressure at 3 m [dBA]	43	42	47	47
Transported air temperature [°C]	-25...+50	-25...+50	-25...+50	-25...+50
SEC class	-	-	-	-
IP rating	IPX4	IPX4	IPX4	IPX4
Motor IP rating	IP54	IP54	IP54	IP54
ErP	2018	2018	2018	2018

BOX-I EC 80x50-3

Sound power level, A-weighted	Total	Octave frequency bands [Hz]								LpA 3 m	LpA 1 m
		63	125	250	500	1000	2000	4000	8000		
L _{WA} to inlet [dBA]	70	36	50	66	60	63	61	60	55	49	59
L _{WA} to outlet [dBA]	73	35	49	66	66	65	68	64	57	53	63
L _{WA} to environment [dBA]	63	39	47	61	57	52	51	45	39	43	53

BOX-I EC 90x50-3 MAX, BOX-I EC 100x50-3 MAX

Sound power level, A-weighted	Total	Octave frequency bands [Hz]								LpA 3 m	LpA 1 m
		63	125	250	500	1000	2000	4000	8000		
L _{WA} to inlet [dBA]	73	46	65	64	67	65	63	60	60	52	62
L _{WA} to outlet [dBA]	74	44	65	67	67	68	64	59	59	53	63
L _{WA} to environment [dBA]	68	48	65	62	58	56	52	48	45	47	57

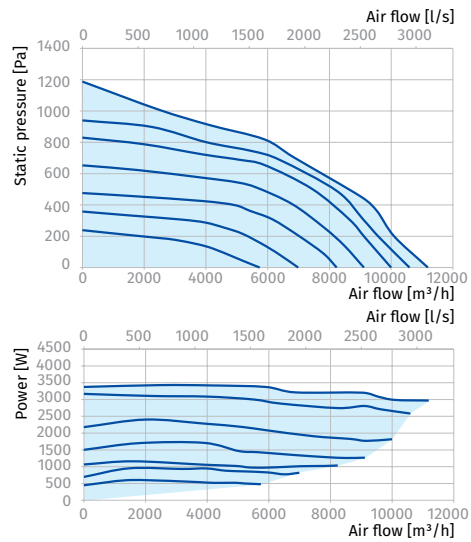
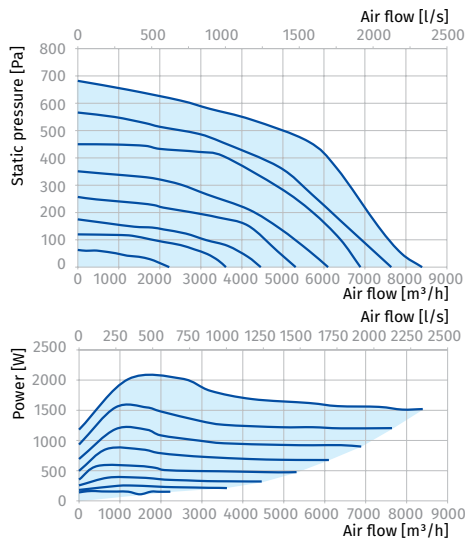

BOX-I EC 80x50-3 MAX

Sound power level, A-weighted	Total	Octave frequency bands [Hz]								LpA 3 m	LpA 1 m
		63	125	250	500	1000	2000	4000	8000		
L _{WA} to inlet [dBA]	69	44	61	60	63	61	59	56	57	48	58
L _{WA} to outlet [dBA]	72	43	63	65	65	66	62	57	57	51	61
L _{WA} to environment [dBA]	62	43	59	56	53	51	47	43	41	42	52

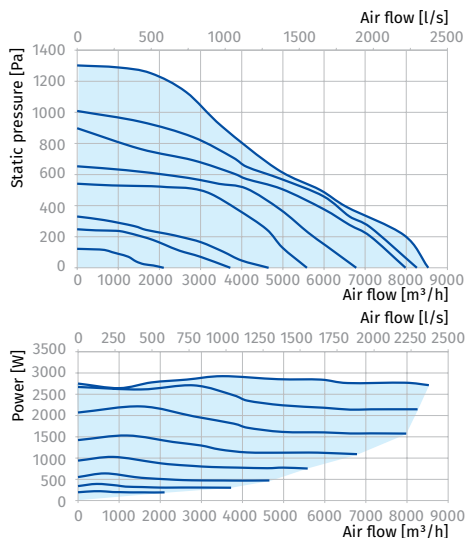

INLINE FANS FOR RECTANGULAR DUCTS

Box-F

Centrifugal fans for rectangular ducts

Use

- Supply and extract ventilation systems installed in various premises.
- Compatible with 400x200 up to 1000x500 mm rectangular air ducts.



Air flow:
up to 9540 m³/h
2650 l/s



Power:
from 244 W



Noise level:
from 45 dBA



Design

- Atmospheric resistant galvanized steel casing and impeller.
- The fan is rated for continuous operation.
- Fitted with standard 20 mm connecting flanges for connection to rectangular air ducts.
- Access cover on the casing for inspection and maintenance operations.
- The fans with standard size from 40x20 up to 60x35 are equipped with a terminal block integrated into the casing with leaded outside sealed electrical lead-in for connection to power mains.
- The fans with standard size from 70x40 up to 100x50 are equipped with an external terminal block for connection to power mains.

Motor

- Four- or six-pole asynchronous motor with external rotor and centrifugal impeller with forward curved blades.
- Due to its impeller design the fan has excellent air dynamic characteristics (high performance and pressure drop).
- Single-phase (E) or three-phase (D) motor modifications.
- Equipped with ball bearings for longer service life.
- Dynamically balanced impeller.
- Overheating protection by built-in thermal switches with leaded outside terminals for connection to external protecting controls.
- The thermal switch terminal leads are designed for connection to respective circuit of the overload relay or respective terminals of the auto-transformer or thyristor speed controller.

Speed control

- Smooth speed control with an external thyristor controller or step speed control with an external auto transformer (both available upon separate order).

Mounting

- The fan is designed for mounting inside rectangular air ducts and can be installed in any position.
- The fan flanges are connected to the air ducts through the bolts inserted into the flange holes.
- Mounting to a round air duct on exhaust flange through a round pipe reducer. Available upon order.
- If flexible vibration-absorbing connectors are used to connect the fan to the air ducts provide their fixation to mounting structures with supports or brackets.
- While mounting provide enough space for accessing the cover for service operations.

INLINE FANS FOR RECTANGULAR DUCTS

Designation key

Series	Flange size (width x height) [cm]	Motor Number of poles	Phase
Box-F	40x20; 50x25; 50x30; 60x30; 60x35; 70x40; 80x50; 90x50; 100x50	4; 6	E: single-phase D: three-phase

Accessories

Silencers	Filter boxes	Electric heaters	Water heaters	Air dampers	Flexible antivibration connectors
 SD	 KFBK / KFBT	 EKH	 WKH	 SL / VG	 EVA

Overall dimensions [mm]

Type	B	B1	B2	H	H1	H2	H3	L	Weight [kg]
Box-F 40x20 4E	400	420	440	200	220	240	255	500	17.5
Box-F 40x20 4D	400	420	440	200	220	240	255	500	17.5
Box-F 50x25 4E	500	520	540	250	270	290	335	640	24.0
Box-F 50x25 4D	500	520	540	250	270	290	335	640	24.0
Box-F 50x30 4E	500	520	540	300	320	340	365	680	33.0
Box-F 50x30 4D	500	520	540	300	320	340	365	680	33.0
Box-F 60x30 4E	600	620	640	300	320	340	375	680	35.0
Box-F 60x30 4D	600	620	640	300	320	340	375	680	35.0
Box-F 60x35 4E	600	620	640	350	370	390	425	735	49.5
Box-F 60x35 4D	600	620	640	350	370	390	425	735	49.5
Box-F 70x40 4D	700	720	740	400	420	440	480	780	60.0
Box-F 80x50 4D	800	820	840	500	520	540	580	820	74.0
Box-F 80x50 6D	800	820	840	500	520	540	580	820	70.0
Box-F 90x50 6D	900	920	940	500	520	540	580	954	90.0
Box-F 100x50 6D	1000	1020	1040	500	520	540	580	954	95.0

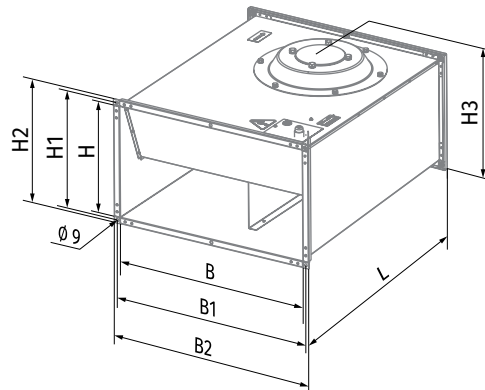

Technical data

Parameters	Box-F 40x20 4E	Box-F 40x20 4D	Box-F 50x25 4E	Box-F 50x25 4D	Box-F 50x30 4E	Box-F 50x30 4D	Box-F 60x30 4E	Box-F 60x30 4D
Voltage [V]	1 ~ 230	3 ~ 400	1 ~ 230	3 ~ 400	1 ~ 230	3 ~ 400	1 ~ 230	3 ~ 400
Frequency [Hz]	50	50	50	50	50	50	50	50
Power [W]	295	282	535	570	710	855	1240	1560
Current [A]	1.32	0.60	2.49	0.94	3.10	1.70	6.45	2.73
Maximum air flow [m³/h (l/s)]	1440 (400)	1470 (408)	1750 (486)	1850 (514)	2350 (653)	2350 (653)	2950 (820)	3740 (1039)
RPM [min ⁻¹]	1350	1300	1250	1270	1230	1300	1210	1310
Sound pressure at 3 m [dBA]	50	49	53	54	57	56	59	57
Transported air temperature [°C]	-25...+40	-25...+45	-20...+40	-20...+40	-25...+70	-20...+50	-25...+50	-25...+65
IP rating	IPX4	IPX4	IPX4	IPX4	IPX4	IPX4	IPX4	IPX4
Motor IP rating	IP44	IP44	IP44	IP44	IP44	IP44	IP44	IP44
ErP	-	-	-	2018	-	-	-	2018

BOX-F 40x20 4E

Sound power level, A-weighted	Total	Octave frequency bands [Hz]								LpA 3 m	LpA 1 m
		63	125	250	500	1000	2000	4000	8000		
LWA to inlet [dBA]	82	68	80	74	70	66	63	63	53	61	71
LWA to outlet [dBA]	83	63	74	79	73	77	74	68	65	63	73
LWA to environment [dBA]	71	41	56	69	63	59	52	48	44	50	60

BOX-F 40x20 4D

Sound power level, A-weighted	Total	Octave frequency bands [Hz]								LpA 3 m	LpA 1 m
		63	125	250	500	1000	2000	4000	8000		
LWA to inlet [dBA]	81	64	79	74	65	66	65	60	55	60	70
LWA to outlet [dBA]	80	62	74	75	70	72	68	70	63	60	70
LWA to environment [dBA]	70	41	53	68	63	61	53	48	40	49	59

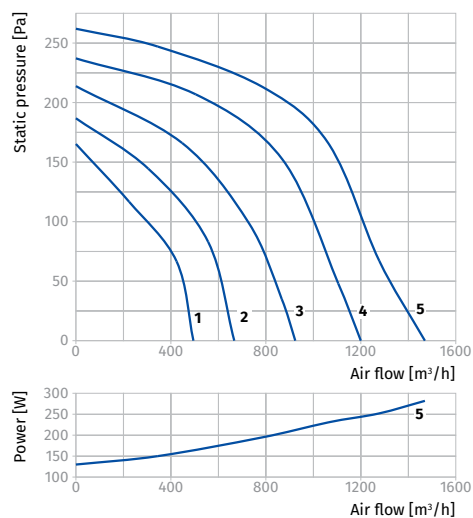
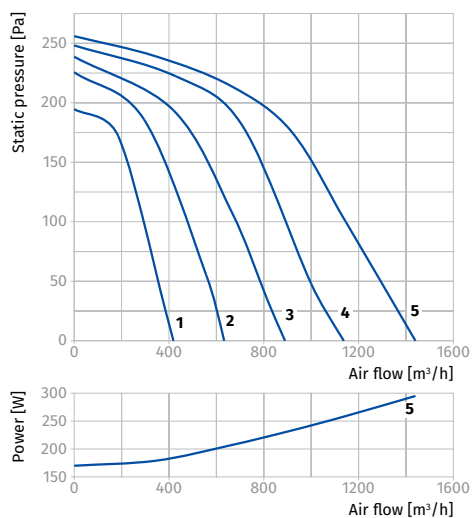
BOX-F 50x25 4E

Sound power level, A-weighted	Total	Octave frequency bands [Hz]								LpA 3 m	LpA 1 m
		63	125	250	500	1000	2000	4000	8000		
LWA to inlet [dBA]	84	69	80	74	68	74	76	74	71	63	73
LWA to outlet [dBA]	86	66	72	71	76	83	79	78	72	66	76
LWA to environment [dBA]	74	50	60	66	65	69	64	63	65	53	63

BOX-F 50x25 4D

Sound power level, A-weighted	Total	Octave frequency bands [Hz]								LpA 3 m	LpA 1 m
		63	125	250	500	1000	2000	4000	8000		
LWA to inlet [dBA]	85	73	81	77	74	77	75	73	70	65	75
LWA to outlet [dBA]	88	68	77	77	80	82	82	81	75	68	78
LWA to environment [dBA]	75	51	60	66	66	70	65	63	66	54	64

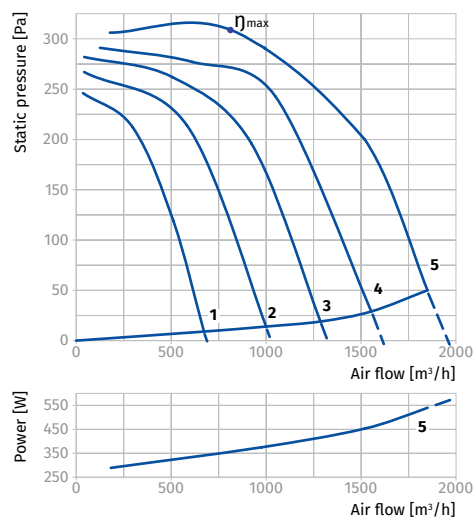
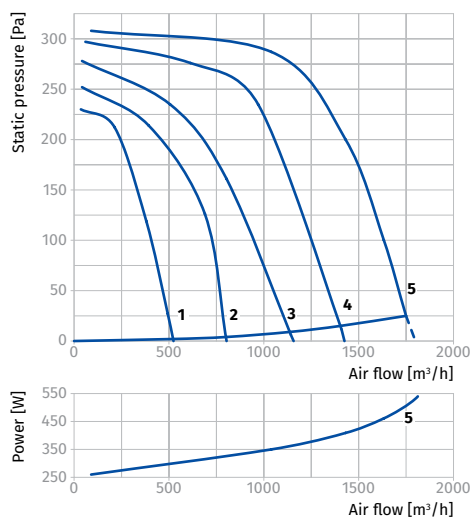

BOX-F 50x30 4E

Sound power level, A-weighted	Total	Octave frequency bands [Hz]								LpA 3 m	LpA 1 m
		63	125	250	500	1000	2000	4000	8000		
LWA to inlet [dBA]	86	75	81	76	74	77	78	76	70	65	75
LWA to outlet [dBA]	88	69	77	74	81	82	81	80	72	67	77
LWA to environment [dBA]	78	57	66	73	67	72	69	61	62	57	67

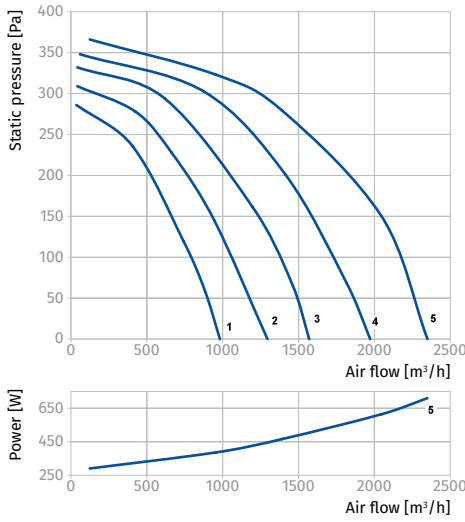

BOX-F 50x30 4D

Sound power level, A-weighted	Total	Octave frequency bands [Hz]								LpA 3 m	LpA 1 m
		63	125	250	500	1000	2000	4000	8000		
LWA to inlet [dBA]	85	76	79	71	72	78	78	76	72	64	74
LWA to outlet [dBA]	86	66	73	75	77	81	80	79	73	66	76
LWA to environment [dBA]	76	56	67	70	68	73	65	58	57	56	66

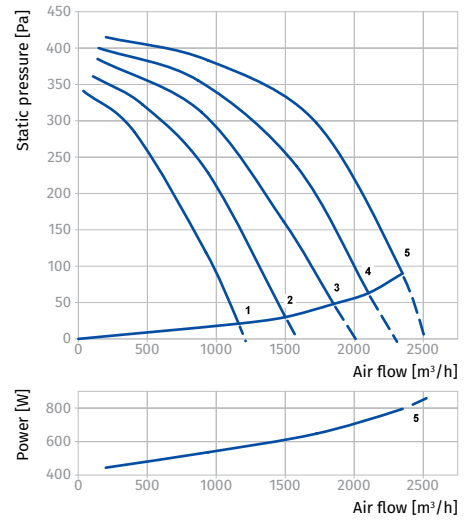

BOX-F 60x30 4E

Sound power level, A-weighted	Total	Octave frequency bands [Hz]								LpA 3 m	LpA 1 m
		63	125	250	500	1000	2000	4000	8000		
LWA to inlet [dBA]	87	72	84	75	72	77	76	77	73	66	76
LWA to outlet [dBA]	89	67	73	77	80	85	82	79	72	68	78
LWA to environment [dBA]	80	48	75	76	70	71	64	61	54	59	69

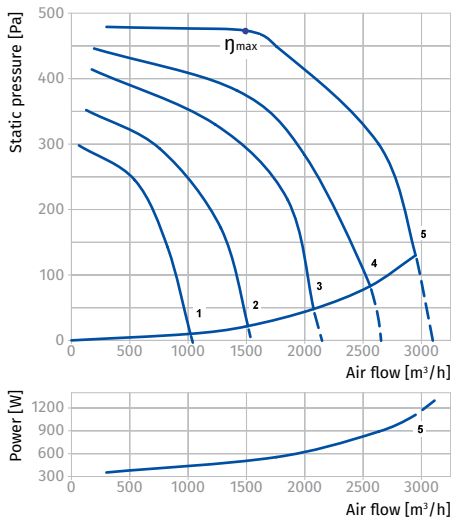

BOX-F 60x30 4D

Sound power level, A-weighted	Total	Octave frequency bands [Hz]								LpA 3 m	LpA 1 m
		63	125	250	500	1000	2000	4000	8000		
LWA to inlet [dBA]	84	69	81	70	71	74	76	71	72	63	73
LWA to outlet [dBA]	86	64	78	73	78	81	77	78	69	66	76
LWA to environment [dBA]	77	49	71	70	72	70	62	55	58	57	67

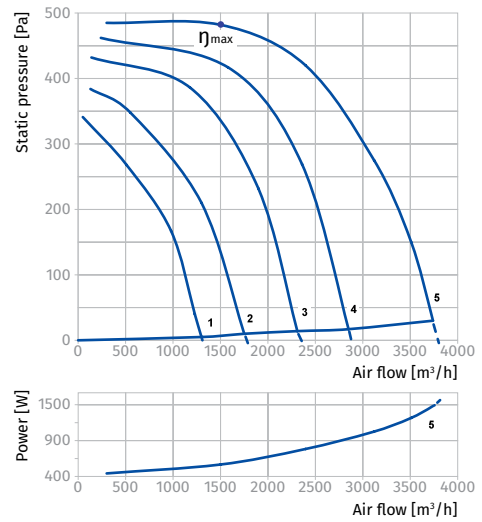

Parameters	Box-F 60x35 4E	Box-F 60x35 4D	Box-F 70x40 4D	Box-F 80x50 4D	Box-F 80x50 6D	Box-F 90x50 6D	Box-F 100x50 6D
Voltage [V]	1 ~ 230	3 ~ 400	3 ~ 400	3 ~ 400	3 ~ 400	3 ~ 400	3 ~ 400
Frequency [Hz]	50	50	50	50	50	50	50
Power [W]	2840	2460	3630	5850	2790	3870	3870
Current [A]	13.90	3.93	6.00	9.35	5.18	7.0	7.0
Maximum air flow [m³/h (l/s)]	4260 (1183)	5020 (1395)	6450 (1792)	8120 (2256)	7610 (2114)	9540 (2650)	9540 (2650)
RPM [min ⁻¹]	1260	1300	1320	1140	830	930	930
Sound pressure at 3 m [dBA]	59	60	65	67	59	61	61
Transported air temperature [°C]	-20...+40	-20...+40	-25...+40	-25...+40	-20...+50	-20...+55	-20...+55
IP rating	IPX4	IPX4	IPX4	IPX4	IPX4	IPX4	IPX4
Motor IP rating	IP44	IP44	IP44	IP44	IP44	IP44	IP44
ErP	-	-	-	-	2018	-	-

BOX-F 60X35 4E

Sound power level, A-weighted	Total	Octave frequency bands [Hz]								LpA 3 m	LpA 1 m
		63	125	250	500	1000	2000	4000	8000		
LWA to inlet [dBA]	85	76	79	70	71	80	77	75	68	65	75
LWA to outlet [dBA]	89	74	78	79	80	83	81	82	73	69	79
LWA to environment [dBA]	80	65	72	76	70	74	66	61	58	59	69

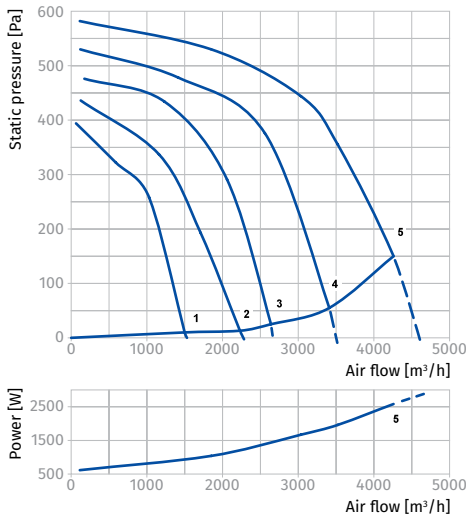

BOX-F 60X35 4D

Sound power level, A-weighted	Total	Octave frequency bands [Hz]								LpA 3 m	LpA 1 m
		63	125	250	500	1000	2000	4000	8000		
LWA to inlet [dBA]	86	73	80	76	77	80	77	76	68	65	75
LWA to outlet [dBA]	90	67	77	78	86	83	78	83	69	70	80
LWA to environment [dBA]	80	69	70	77	69	72	70	59	50	60	70

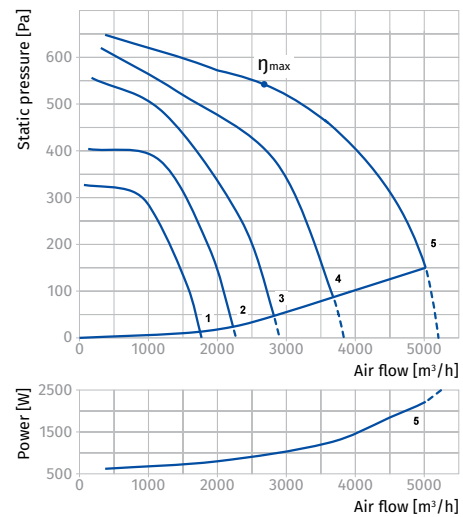

BOX-F 70X40 4D

Sound power level, A-weighted	Total	Octave frequency bands [Hz]								LpA 3 m	LpA 1 m
		63	125	250	500	1000	2000	4000	8000		
LWA to inlet [dBA]	90	86	83	76	77	81	79	77	73	69	79
LWA to outlet [dBA]	92	78	82	79	82	87	85	81	75	71	81
LWA to environment [dBA]	86	64	74	80	78	81	73	72	68	65	75

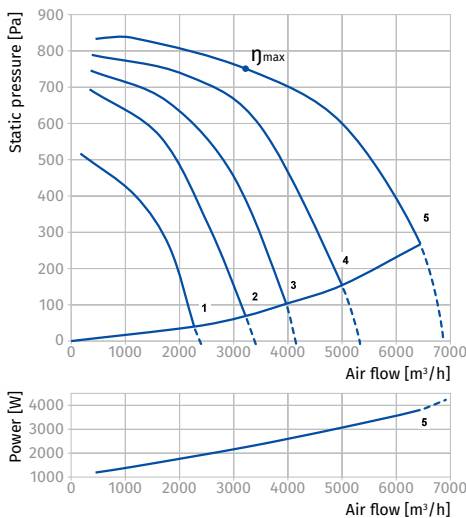

BOX-F 80X50 4D

Sound power level, A-weighted	Total	Octave frequency bands [Hz]								LpA 3 m	LpA 1 m
		63	125	250	500	1000	2000	4000	8000		
LWA to inlet [dBA]	91	80	83	84	78	84	83	78	75	70	80
LWA to outlet [dBA]	96	77	82	81	88	92	91	86	83	76	86
LWA to environment [dBA]	87	72	80	79	77	83	78	72	71	67	77

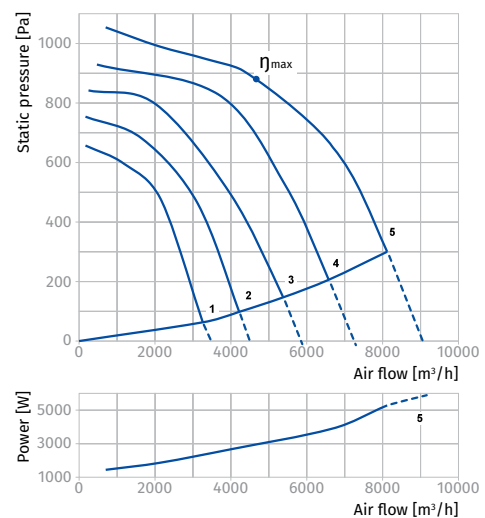

INLINE FANS FOR RECTANGULAR DUCTS

BOX-F 80X50 6D

Sound power level, A-weighted	Total	Octave frequency bands [Hz]								LpA 3 m	LpA 1 m
		63	125	250	500	1000	2000	4000	8000		
LWA to inlet [dBA]	86	75	78	80	74	80	78	74	71	66	76
LWA to outlet [dBA]	90	71	76	75	81	85	84	79	77	69	79
LWA to environment [dBA]	80	65	73	72	70	75	71	65	64	59	69

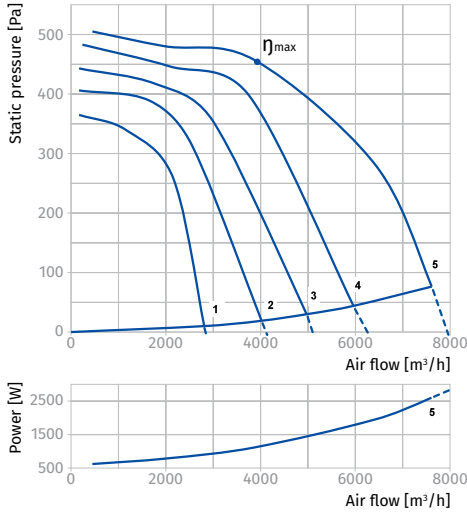

BOX-F 90X50 6D

Sound power level, A-weighted	Total	Octave frequency bands [Hz]								LpA 3 m	LpA 1 m
		63	125	250	500	1000	2000	4000	8000		
LWA to inlet [dBA]	91	80	82	78	84	85	82	78	73	70	80
LWA to outlet [dBA]	99	78	80	86	97	90	89	88	78	79	89
LWA to environment [dBA]	81	64	68	79	74	71	70	66	58	61	71

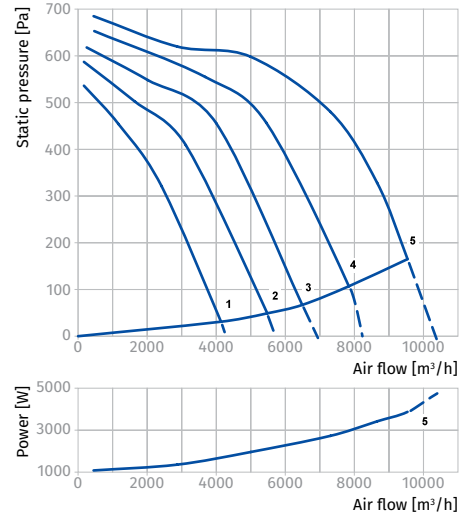

BOX-F 100X50 6D

Sound power level, A-weighted	Total	Octave frequency bands [Hz]								LpA 3 m	LpA 1 m
		63	125	250	500	1000	2000	4000	8000		
LWA to inlet [dBA]	91	80	82	78	84	85	82	78	73	70	80
LWA to outlet [dBA]	99	78	80	86	97	90	89	88	78	79	89
LWA to environment [dBA]	81	64	68	79	74	71	70	66	58	61	71

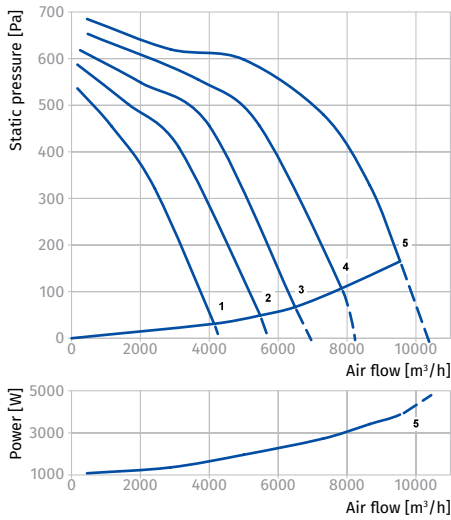

Box-FI

Centrifugal fans in sound-insulated casing for rectangular ducts

Use

- Supply and extract ventilation systems installed in various premises.
- Compatible with 400x200 up to 1000x500 mm rectangular air ducts.



Air flow:
up to 9540 m³/h
2650 l/s



Power:
from 244 W



Noise level:
from 37 dBA



Design

- Atmospheric resistant galvanized steel casing and impeller.
- The casing is heat- and sound-insulated with 50 mm mineral wool.
- The fan is rated for continuous operation.
- Fitted with standard 20 mm connecting flanges for connection to rectangular air ducts.
- Access cover on the casing for inspection and maintenance operations.

Motor

- Four- or six-pole asynchronous motor with external rotor and centrifugal impeller with forward curved blades.
- Due to its impeller design the fan has excellent air dynamic characteristics (high performance and pressure drop).
- Single-phase (**E**) or three-phase (**D**) motor modifications.
- Equipped with ball bearings for longer service life.
- Dynamically balanced impeller.
- Overheating protection by built-in thermal switches with leaded outside terminals for connection to external protecting controls.
- The thermal switch terminal leads are designed for connection to respective circuit of the overload relay or respective terminals of the auto-transformer or thyristor speed controller.

Speed control

- Smooth speed control with an external thyristor controller or step speed control with an external auto transformer (both available upon separate order).

Mounting

- The fan is designed for mounting inside rectangular air ducts and can be installed in any position.
- The fan flanges are connected to the air ducts through the bolts inserted into the flange holes.
- Mounting to a round air duct on exhaust flange through a round pipe reducer. Available upon order.
- If flexible vibration-absorbing connectors are used to connect the fan to the air ducts provide their fixation to mounting structures with supports or brackets.
- While mounting provide enough space for accessing the cover for service operations.

INLINE FANS FOR RECTANGULAR DUCTS

Designation key

Series	Flange size (width x height) [cm]	Motor Number of poles	Phase
Box-FI	40x20; 50x25; 50x30; 60x30; 60x35; 70x40; 80x50; 90x50; 100x50	4; 6	E: single-phase D: three-phase

Accessories

Silencers	Filter boxes	Electric heaters	Water heaters	Air dampers	Flexible antivibration connectors
 SD	 KFBK / KFBT	 EKH	 WKH	 SL / VG	 EVA

Overall dimensions [mm]

Type	B	B1	B2	B3	H	H1	H2	H3	L	Weight [kg]
Box-FI 40x20 4E	400	420	440	470	200	220	240	360	500	29
Box-FI 40x20 4D	400	420	440	470	200	220	240	360	500	29
Box-FI 50x25 4E	500	520	540	570	250	270	290	410	640	40.5
Box-FI 50x25 4D	500	520	540	570	250	270	290	410	640	40.5
Box-FI 50x30 4E	500	520	540	570	300	320	340	460	680	52.5
Box-FI 50x30 4D	500	520	540	570	300	320	340	460	680	52.5
Box-FI 60x30 4E	600	620	640	670	300	320	340	480	680	56
Box-FI 60x30 4D	600	620	640	670	300	320	340	480	680	56
Box-FI 60x35 4E	600	620	640	670	350	370	390	530	735	72
Box-FI 60x35 4D	600	620	640	670	350	370	390	530	735	72
Box-FI 70x40 4D	700	720	-	800	400	420	-	620	880	103
Box-FI 80x50 4D	800	820	-	900	500	520	-	720	935	120
Box-FI 80x50 6D	800	820	-	900	500	520	-	720	935	127
Box-FI 90x50 6D	900	920	-	1000	500	520	-	720	1000	142
Box-FI 100x50 6D	1000	1020	-	1100	500	520	-	720	1000	150

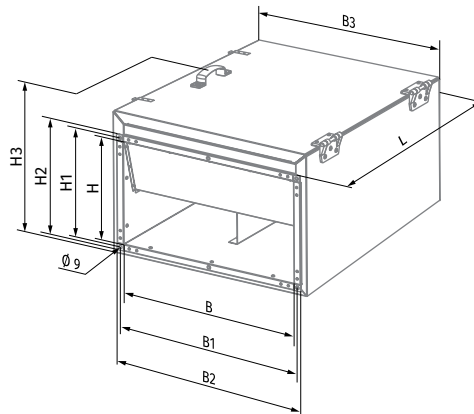

Technical data

Parameters	Box-FI 40x20 4E	Box-FI 40x20 4D	Box-FI 50x25 4E	Box-FI 50x25 4D	Box-FI 50x30 4E	Box-FI 50x30 4D	Box-FI 60x30 4E	Box-FI 60x30 4D
Voltage [V]	1 ~ 230	3 ~ 400	1 ~ 230	3 ~ 400	1 ~ 230	3 ~ 400	1 ~ 230	3 ~ 400
Frequency [Hz]	50	50	50	50	50	50	50	50
Power [W]	295	282	535	570	710	855	1240	1560
Current [A]	1.32	0.60	2.49	0.94	3.10	1.70	6.45	2.73
Maximum air flow [m³/h (l/s)]	1440 (400)	1470 (408)	1750 (486)	1850 (514)	2350 (653)	2350 (653)	2950 (820)	3740 (1039)
RPM [min ⁻¹]	1350	1300	1250	1270	1230	1300	1210	1310
Sound pressure at 3 m [dBA]	50	49	53	54	57	56	59	57
Transported air temperature [°C]	-25...+40	-25...+45	-20...+40	-20...+40	-25...+70	-20...+50	-25...+50	-25...+65
IP rating	IPX4	IPX4	IPX4	IPX4	IPX4	IPX4	IPX4	IPX4
Motor IP rating	IP44	IP44	IP44	IP44	IP44	IP44	IP44	IP44
ErP	-	-	-	2018	-	-	-	2018

BOX-FI 40x20 4E

Sound power level, A-weighted	Total	Octave frequency bands [Hz]								LpA 3 m	LpA 1 m
		63	125	250	500	1000	2000	4000	8000		
LWA to inlet [dBA]	82	68	80	74	70	66	63	63	53	61	71
LWA to outlet [dBA]	83	63	74	79	73	77	74	68	65	63	73
LWA to environment [dBA]	71	41	56	69	63	59	52	48	44	50	60

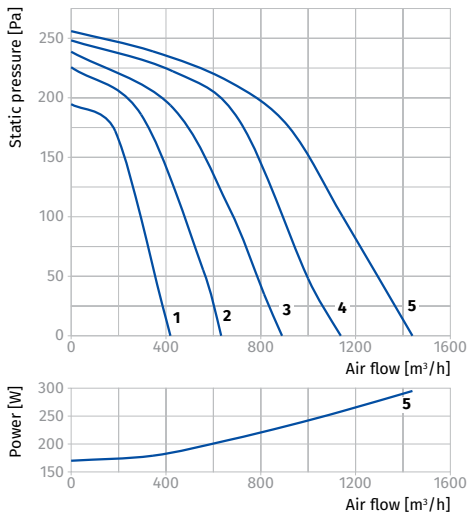

BOX-FI 40x20 4D

Sound power level, A-weighted	Total	Octave frequency bands [Hz]								LpA 3 m	LpA 1 m
		63	125	250	500	1000	2000	4000	8000		
LWA to inlet [dBA]	81	64	79	74	65	66	65	60	55	60	70
LWA to outlet [dBA]	80	62	74	75	70	72	68	70	63	60	70
LWA to environment [dBA]	70	41	53	68	63	61	53	48	40	49	59

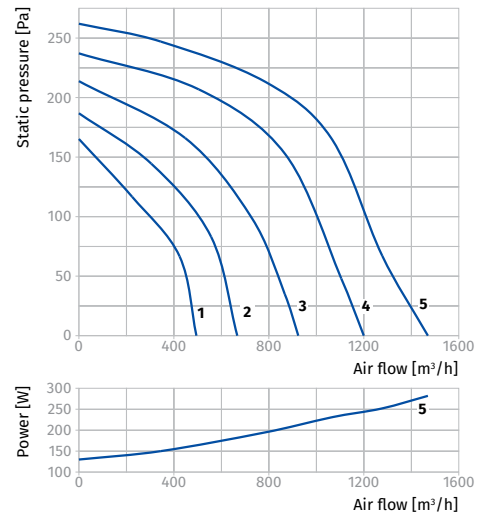

BOX-FI 50x25 4E

Sound power level, A-weighted	Total	Octave frequency bands [Hz]								LpA 3 m	LpA 1 m
		63	125	250	500	1000	2000	4000	8000		
LWA to inlet [dBA]	84	69	80	74	68	74	76	74	71	63	73
LWA to outlet [dBA]	86	66	72	71	76	83	79	78	72	66	76
LWA to environment [dBA]	74	50	60	66	65	69	64	63	65	53	63

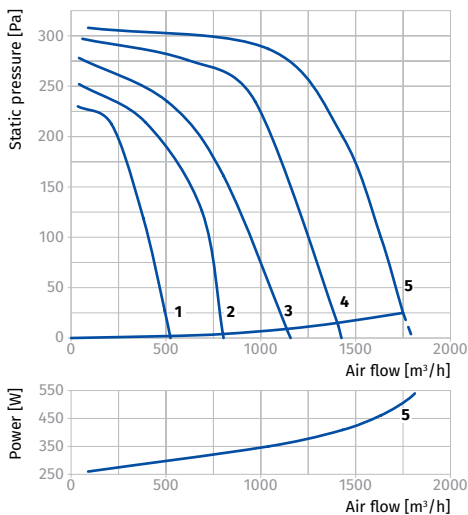

BOX-FI 50x25 4D

Sound power level, A-weighted	Total	Octave frequency bands [Hz]								LpA 3 m	LpA 1 m
		63	125	250	500	1000	2000	4000	8000		
LWA to inlet [dBA]	85	73	81	77	74	77	75	73	70	65	75
LWA to outlet [dBA]	88	68	77	77	80	82	82	81	75	68	78
LWA to environment [dBA]	75	51	60	66	66	70	65	63	66	54	64

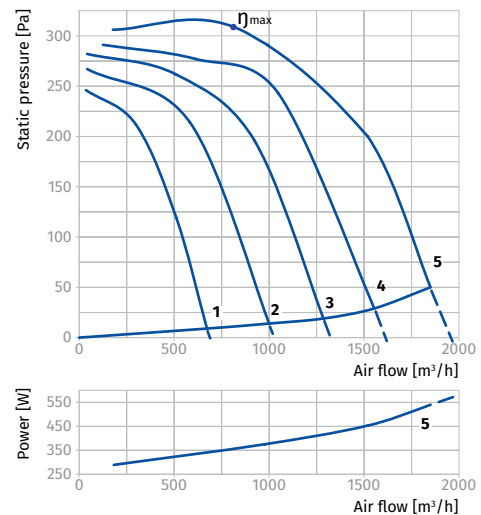

BOX-FI 50x30 4E

Sound power level, A-weighted	Total	Octave frequency bands [Hz]								LpA 3 m	LpA 1 m
		63	125	250	500	1000	2000	4000	8000		
LWA to inlet [dBA]	86	75	81	76	74	77	78	76	70	65	75
LWA to outlet [dBA]	88	69	77	74	81	82	81	80	72	67	77
LWA to environment [dBA]	78	57	66	73	67	72	69	61	62	57	67

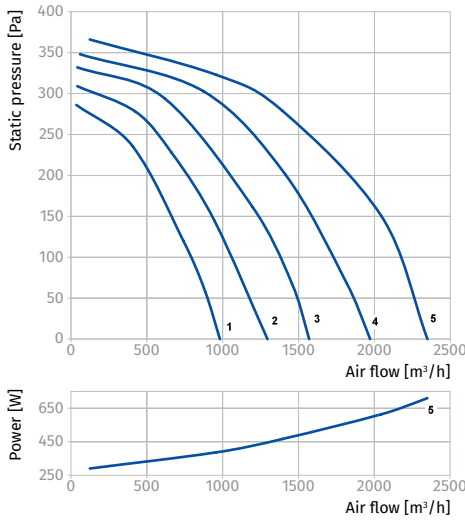

BOX-FI 50x30 4D

Sound power level, A-weighted	Total	Octave frequency bands [Hz]								LpA 3 m	LpA 1 m
		63	125	250	500	1000	2000	4000	8000		
LWA to inlet [dBA]	85	76	79	71	72	78	78	76	72	64	74
LWA to outlet [dBA]	86	66	73	75	77	81	80	79	73	66	76
LWA to environment [dBA]	76	56	67	70	68	73	65	58	57	56	66

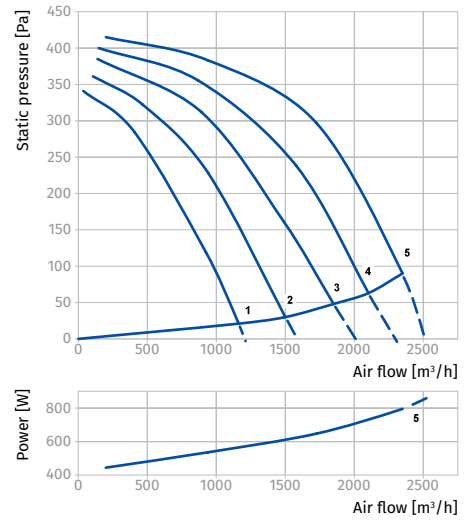

BOX-FI 60x30 4E

Sound power level, A-weighted	Total	Octave frequency bands [Hz]								LpA 3 m	LpA 1 m
		63	125	250	500	1000	2000	4000	8000		
LWA to inlet [dBA]	87	72	84	75	72	77	76	77	73	66	76
LWA to outlet [dBA]	89	67	73	77	80	85	82	79	72	68	78
LWA to environment [dBA]	80	48	75	76	70	71	64	61	54	59	69

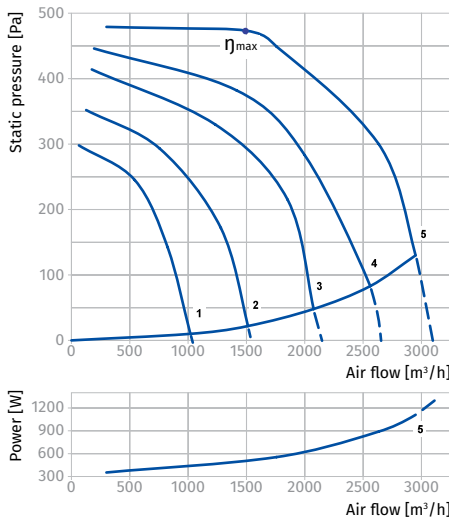

BOX-FI 60x30 4D

Sound power level, A-weighted	Total	Octave frequency bands [Hz]								LpA 3 m	LpA 1 m
		63	125	250	500	1000	2000	4000	8000		
LWA to inlet [dBA]	84	69	81	70	71	74	76	71	72	63	73
LWA to outlet [dBA]	86	64	78	73	78	81	77	78	69	66	76
LWA to environment [dBA]	77	49	71	70	72	70	62	55	58	57	67

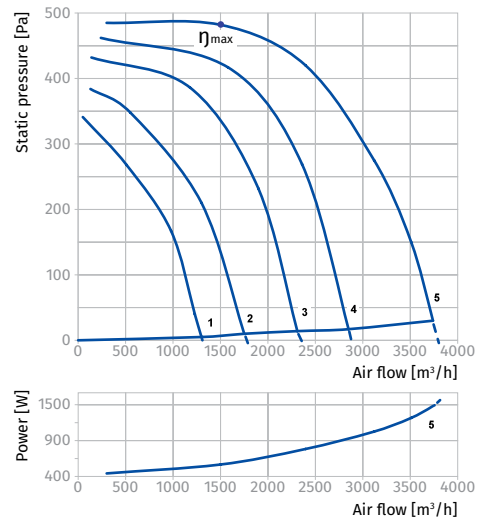

INLINE FANS FOR RECTANGULAR DUCTS

Parameters	Box-FI 60x35 4E	Box-FI 60x35 4D	Box-FI 70x40 4D	Box-FI 80x50 4D	Box-FI 80x50 6D	Box-FI 90x50 6D	Box-FI 100x50 6D
Voltage [V]	1 ~ 230	3 ~ 400	3 ~ 400	3 ~ 400	3 ~ 400	3 ~ 400	3 ~ 400
Frequency [Hz]	50	50	50	50	50	50	50
Power [W]	2840	2460	3630	5850	2790	3870	3870
Current [A]	13.90	3.93	6.00	9.35	5.18	7.0	7.0
Maximum air flow [m ³ /h (l/s)]	4260 (1183)	5020 (1395)	6450 (1792)	8120 (2256)	7610 (2114)	9540 (2650)	9540 (2650)
RPM [min ⁻¹]	1260	1300	1320	1140	830	930	930
Sound pressure at 3 m [dBA]	59	60	65	67	59	61	61
Transported air temperature [°C]	-20...+40	-20...+40	-25...+40	-25...+40	-20...+50	-20...+55	-20...+55
IP rating	IPX4	IPX4	IPX4	IPX4	IPX4	IPX4	IPX4
Motor IP rating	IP44	IP44	IP44	IP44	IP44	IP44	IP44
ErP	-	-	-	-	2018	-	-

BOX-FI 60X35 4E

Sound power level, A-weighted	Total	Octave frequency bands [Hz]								LpA 3 m	LpA 1 m
		63	125	250	500	1000	2000	4000	8000		
LWA to inlet [dBA]	85	76	79	70	71	80	77	75	68	65	75
LWA to outlet [dBA]	89	74	78	79	80	83	81	82	73	69	79
LWA to environment [dBA]	80	65	72	76	70	74	66	61	58	59	69

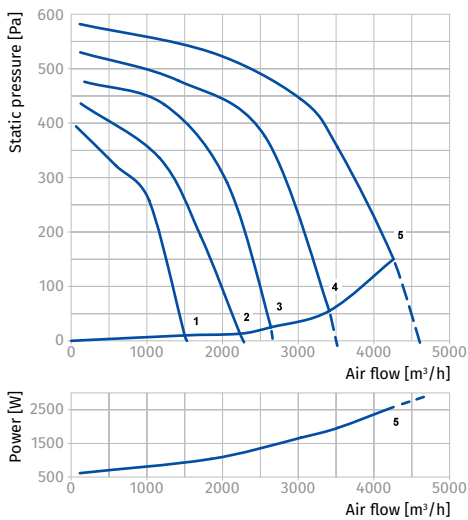
BOX-FI 60X35 4D

Sound power level, A-weighted	Total	Octave frequency bands [Hz]								LpA 3 m	LpA 1 m
		63	125	250	500	1000	2000	4000	8000		
LWA to inlet [dBA]	86	73	80	76	77	80	77	76	68	65	75
LWA to outlet [dBA]	90	67	77	78	86	83	78	83	69	70	80
LWA to environment [dBA]	80	69	70	77	69	72	70	59	50	60	70

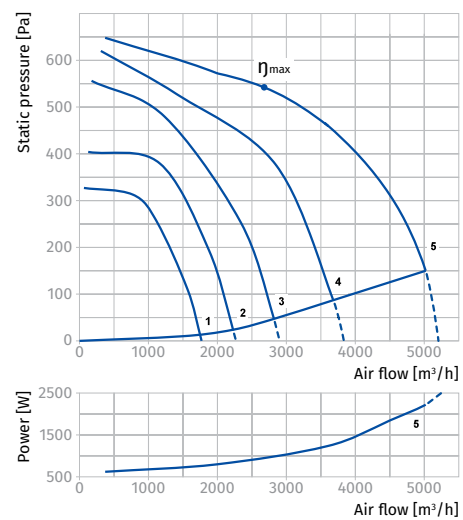
BOX-FI 70X40 4D

Sound power level, A-weighted	Total	Octave frequency bands [Hz]								LpA 3 m	LpA 1 m
		63	125	250	500	1000	2000	4000	8000		
LWA to inlet [dBA]	90	86	83	76	77	81	79	77	73	69	79
LWA to outlet [dBA]	92	78	82	79	82	87	85	81	75	71	81
LWA to environment [dBA]	86	64	74	80	78	81	73	72	68	65	75

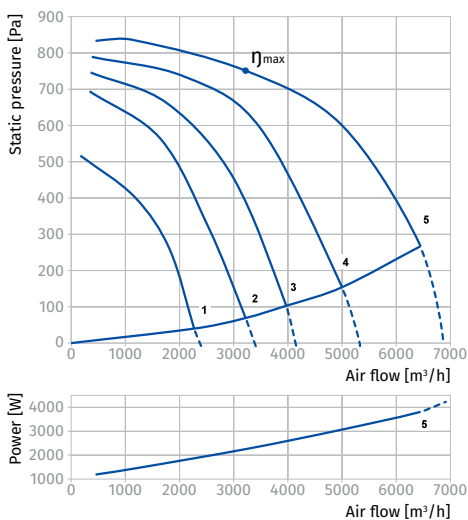

BOX-FI 80X50 4D

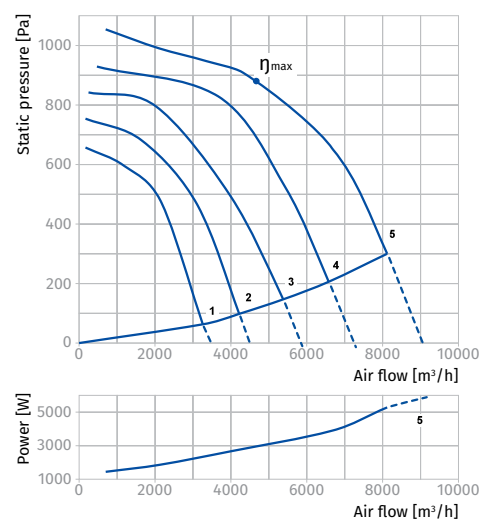
Sound power level, A-weighted	Total	Octave frequency bands [Hz]								LpA 3 m	LpA 1 m
		63	125	250	500	1000	2000	4000	8000		
LWA to inlet [dBA]	91	80	83	84	78	84	83	78	75	70	80
LWA to outlet [dBA]	96	77	82	81	88	92	91	86	83	76	86
LWA to environment [dBA]	87	72	80	79	77	83	78	72	71	67	77

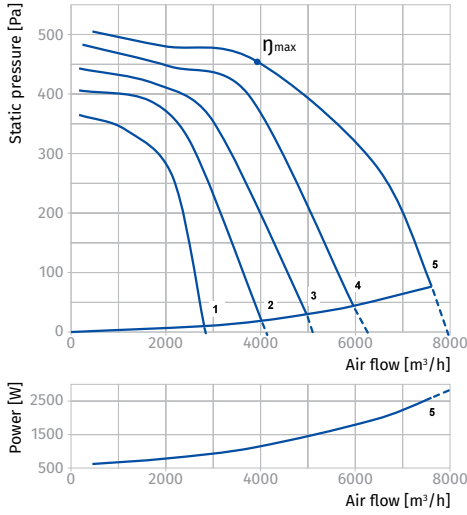

BOX-FI 80X50 6D

Sound power level, A-weighted	Total	Octave frequency bands [Hz]								LpA 3 m	LpA 1 m
		63	125	250	500	1000	2000	4000	8000		
LWA to inlet [dBA]	86	75	78	80	74	80	78	74	71	66	76
LWA to outlet [dBA]	90	71	76	75	81	85	84	79	77	69	79
LWA to environment [dBA]	80	65	73	72	70	75	71	65	64	59	69



BOX-FI 90X50 6D

Sound power level, A-weighted	Total	Octave frequency bands [Hz]								LpA 3 m	LpA 1 m
		63	125	250	500	1000	2000	4000	8000		
LWA to inlet [dBA]	91	80	82	78	84	85	82	78	73	70	80
LWA to outlet [dBA]	99	78	80	86	97	90	89	88	78	79	89
LWA to environment [dBA]	81	64	68	79	74	71	70	66	58	61	71

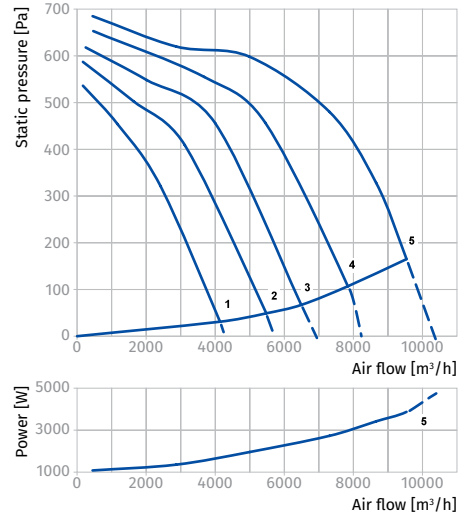

BOX-FI 100X50 6D

Sound power level, A-weighted	Total	Octave frequency bands [Hz]								LpA 3 m	LpA 1 m
		63	125	250	500	1000	2000	4000	8000		
LWA to inlet [dBA]	91	80	82	78	84	85	82	78	73	70	80
LWA to outlet [dBA]	99	78	80	86	97	90	89	88	78	79	89
LWA to environment [dBA]	81	64	68	79	74	71	70	66	58	61	71

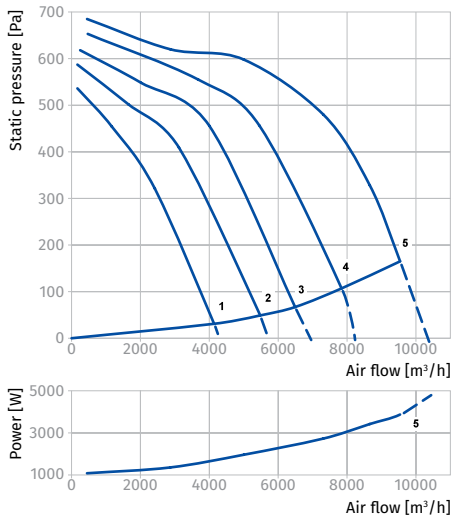

Kamin / Kamin-ER

Chimney centrifugal fans

Use

- For arranging warm air distribution system from chimney room to other rooms.
- For heating of occasionally or seasonally occupied buildings.
- Operating temperature from 0 to 150 °C.
- Compatible with Ø 125 up to 160 mm round air ducts.



Air flow:
up to 613 m³/h
170 l/s



Power:
from 32 W



Noise level:
from 37 dBA



Design

- Atmospheric resistant galvanized steel casing and impeller.
- Thermal and heat-insulation with non-flammable mineral wool.
- The casing is perforated for internal air circulation for cooling the motor down.
- The casing has fixing for connection of extra options (filter, mixing chamber, bypass system).
- Power is supplied to the fan through an external terminal box with sealed electric lead-in.
- Switches on and off at set temperatures. Regulation by built-in temperature regulator.



Motor

- Single-phase asynchronous motor. Centrifugal impeller with forward curved blades.
- The **Kamin-ER** fan is equipped with an external rotor motor.
- The motor is placed off the air flow and is equipped with extra axial impeller for motor cooling and blowing off.
- Motor insulation class **F**.
- Equipped with ball bearings for longer service life.
- Dynamically balanced impeller.
- Overheating protection by built-in thermal switches with automatic restart.

Speed control

- Smooth speed control with an external thyristor controller or step speed control with an external auto transformer (both available upon separate order).

Mounting

- Suitable for installation in any mounting position with respect to air flow direction in the system.
- Warm air distribution from the fan to other premises through the mounted air ducts.

Options

AF: metal filter-box for air purification. Filter class **G3**.

KF: metal mixing chamber for cold air supply. The chamber includes a temperature regulating damper and filter for air purification. The chamber provides cold air supply when the air temperature exceeds 90 °C and hot air removal when the fan is off.

GF: gravity damper to prevent air back draft in the system. Together with the **KF** mixing chamber provides motor overheating protection (BYPASS system). When the motor is not running (e.g. during power cut-off), the gravity damper is closed and warm air is distributed through the mixing chamber and connected air ducts to other rooms. If the transported air temperature is too high (exceeds +120 °C), the BYPASS system stabilizes the temperature by opening the damper of the mixing chamber and by cold air supply.



Designation key

Series	Modification	Duct diameter [mm]	Motor modification	Options
Kamin	_: standard -ER: external rotor motor	125; 150; 160	_: standard max: high-powered motor	US: speed switch AF: metal filter-box KF: metal mixing chamber GF: gravity damper

Accessories

Filter boxes	Filters	Mixing chambers	Gravity dampers	Clamps
 AF	 FP-AF	 KF	 GF	 K

OPERATING LOGIC OF THE FAN KAMIN WITH AF FILTER-BOX

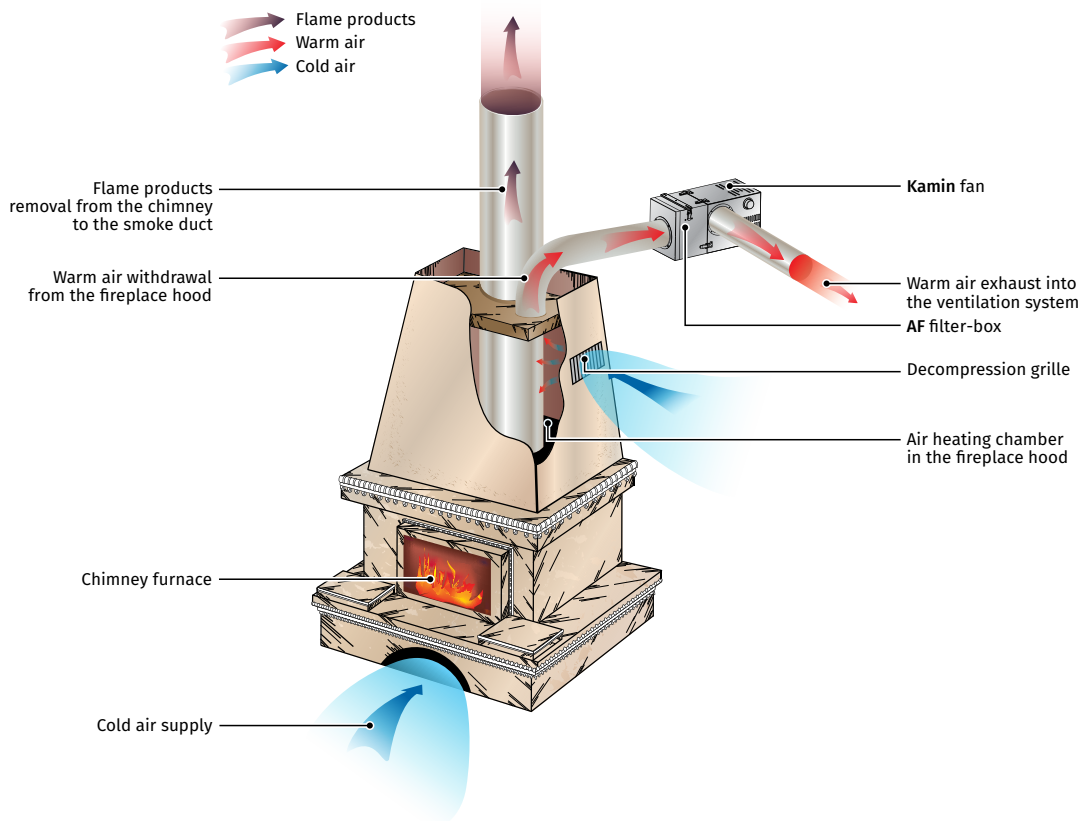

OPERATING LOGIC OF THE FAN KAMIN WITH BYPASS SYSTEM

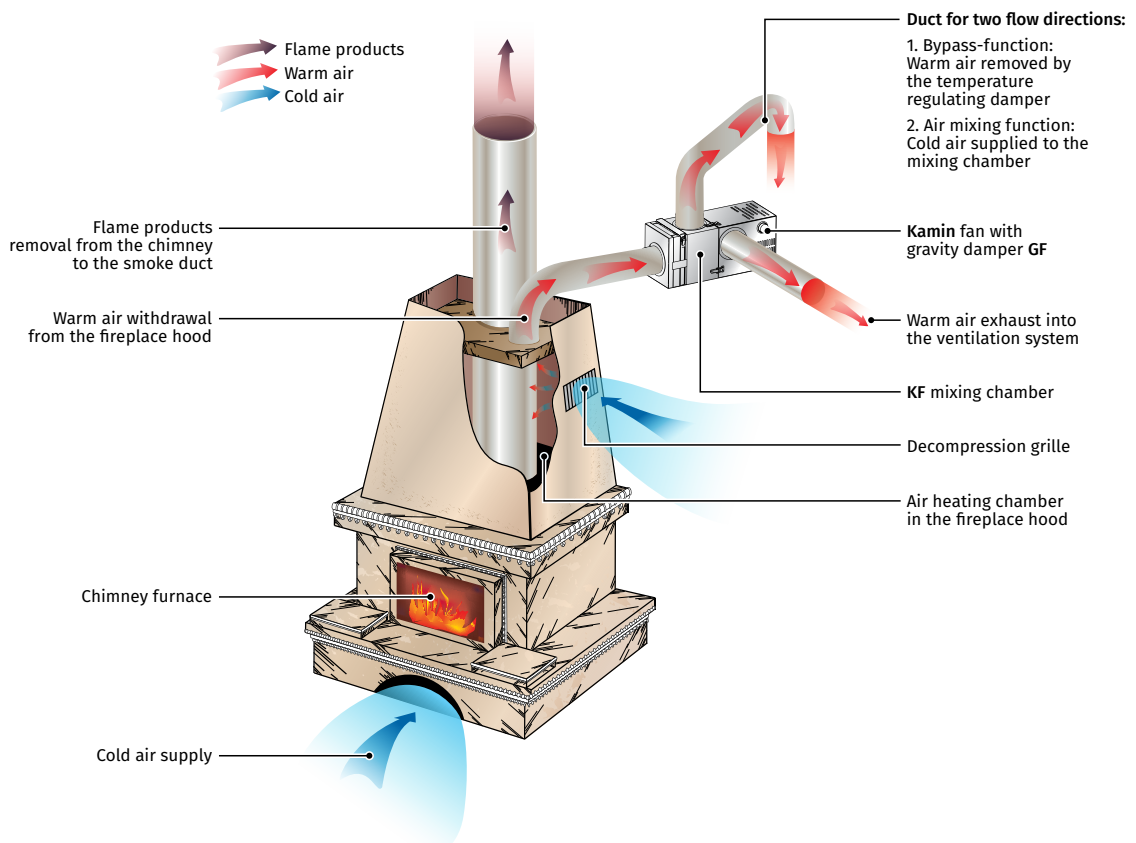

Technical data

Parameters	Kamin 125	Kamin 150	Kamin 160
Voltage [V]	1 ~ 230	1 ~ 230	1 ~ 230
Frequency [Hz]	50	50	50
Power [W]	108	115	116
Current [A]	0.81	0.84	0.86
Maximum air flow [m ³ /h (l/s)]	400 (111)	520 (144)	540 (150)
RPM [min ⁻¹]	1300	1280	1270
Sound pressure at 3 m [dBA]	42	42	42
Max. transported air temperature [°C]	+150	+150	+150
IP rating	IPX2	IPX2	IPX2
Motor IP rating	IP42	IP42	IP42

Parameters	Kamin-ER 125	Kamin-ER 150	Kamin-ER 150 max	Kamin-ER 160
Voltage [V]	1 ~ 230	1 ~ 230	1 ~ 230	1 ~ 230
Frequency [Hz]	50	50	50	50
Power [W]	32	43	115	44
Current [A]	0.14	0.19	0.51	0.19
Maximum air flow [m ³ /h (l/s)]	350 (97)	450 (125)	613 (170)	470 (131)
RPM [min ⁻¹]	1335	1165	1296	1110
Sound pressure at 3 m [dBA]	37	39	45	39
Max. transported air temperature [°C]	+150	+150	+150	+150
IP rating	IPX2	IPX2	IPX2	IPX2
Motor IP rating	IP42	IP42	IP42	IP42

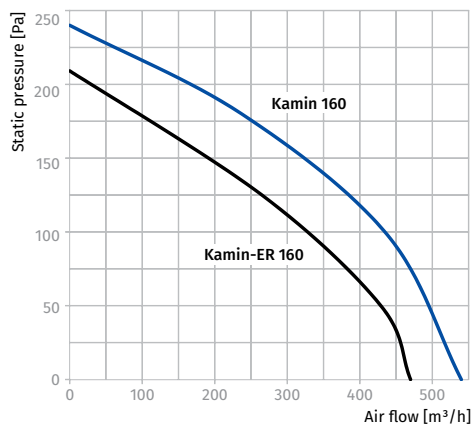
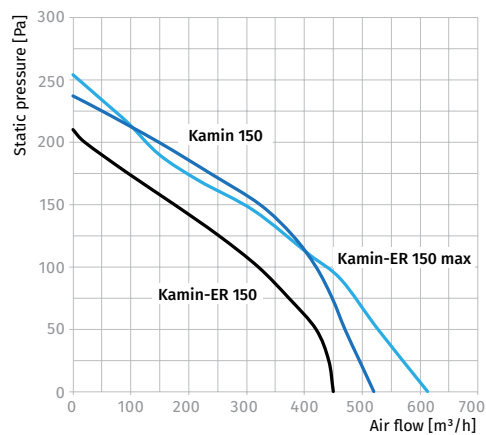
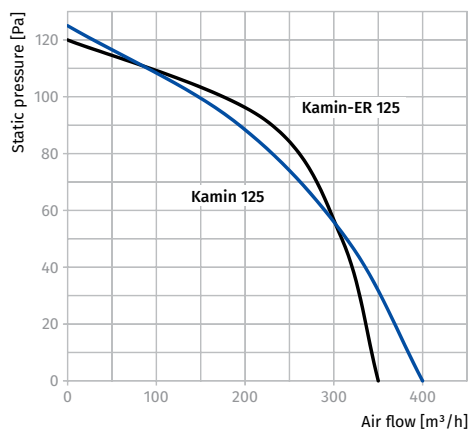

Overall dimensions [mm]

KAMIN / KAMIN-ER SERIES FANS

Type	Ø D	B	H	H1	L	P	Weight [kg]
Kamin 125	124	245	350	300	260	50	4.5
Kamin 150	149	285	350	300	300	50	5.7
Kamin 160	159	285	350	300	300	50	5.7
Kamin-ER 125	124	245	320	270	260	50	5.6
Kamin-ER 150	149	285	320	270	300	50	6.8
Kamin-ER 150 max	149	285	320	270	300	50	6.8
Kamin-ER 160	159	285	320	270	300	50	6.8

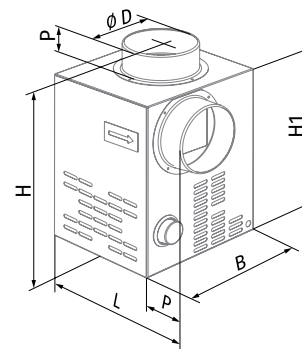

KAMIN / KAMIN-ER SERIES FANS EQUIPPED WITH FILTER BOX AF

Type	Extra option	Ø D	B	H	H1	L	P	Weight [kg]
Kamin 125	AF 125	124	245	530	480	260	50	6.7
Kamin 150	AF 150	149	285	540	490	300	50	8.7
Kamin 160	AF 160	159	285	540	490	300	50	8.7
Kamin-ER 125	AF 125	124	245	500	450	260	50	7.8
Kamin-ER 150	AF 150	149	285	510	460	300	50	9.8
Kamin-ER 150 max	AF 150	149	285	510	460	300	50	9.8
Kamin-ER 160	AF 160	159	285	510	460	300	50	9.8

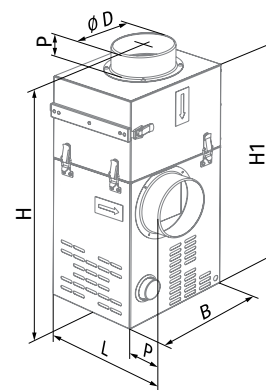

KAMIN / KAMIN-ER SERIES FANS EQUIPPED WITH MIXING CHAMBER KF AND DAMPER GF

Type	Extra option	Ø D	B	H	H1	L	P	Weight [kg]
Kamin 125	KF 125 / KF 125 + GF 125 (BYPASS)	124	245	610	560	260	50	8.3
Kamin 150	KF 150 / KF 150 + GF 150 (BYPASS)	149	285	650	600	300	50	9.7
Kamin 160	KF 160 / KF 160 + GF 160 (BYPASS)	159	285	650	600	300	50	9.7
Kamin-ER 125	KF 125 / KF 125 + GF 125 (BYPASS)	124	245	580	530	260	50	9.4
Kamin-ER 150	KF 150 / KF 150 + GF 150 (BYPASS)	149	285	620	570	300	50	10.8
Kamin-ER 150 max	KF 150 / KF 150 + GF 150 (BYPASS)	149	285	620	570	300	50	10.8
Kamin-ER 160	KF 160 / KF 160 + GF 160 (BYPASS)	159	285	620	570	300	50	10.8

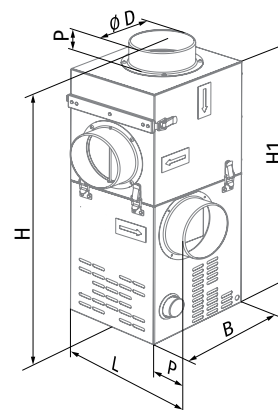

Valeo

Mono-pipe ventilation exhaust centrifugal fans

Use

- Exhaust ventilation systems installed in high-rise buildings and premises.
- For buildings with a mono-pipe ventilation system.
- For mounting in kitchens and bathrooms.
- Installation in a casing for flush or surface mounting.



Air flow:
up to 100 m³/h
28 l/s



Power:
from 15 W



Noise level:
from 27 dBA



Design

- The Valeo ventilation unit is designed for installation in a plastic or fire-proof casing.
- The front panel is made of snow-white UV-resistant plastic.
- Filter with filter class G4 for motor, impeller and ductwork system protection against soiling.
- The filter is easily accessible for service operations.
- The ventilation unit with the motor is fixed inside the casing with special latches.
- Due to modern design and various colour modifications the front panel matches well with any interior.

Motor

- Two-speed motor with a centrifugal impeller. Minimum energy demand.
- The impeller has forward curved blades.
- Automatic maintaining of constant air flow depending on variable air resistance of the duct.
- Balanced impeller ensures low noise operation.
- Best aerodynamic characteristics due to a special scroll casing design.
- Ball bearings provide long service life.

Speed control

- Step speed control with an external speed controller, e.g. a CDP-3/5 model which is available upon order.
- Wide range of system controls with programmable parameters (timer, adjustable timer, internal switch, photo sensor, humidity sensor).





Options

- Timer (Valeo...T)**
Depending on wiring connection the fan is off or runs permanently at low speed. The fan is turned to higher speed with an external switch 50 s after activation. After turning the switch off the fan continues operating within 6 min at higher speed and then reverts to the default operation mode.
- Adjustable timer (Valeo...TR)**
Depending on wiring connection the fan is off or runs permanently at low speed. If the fan is turned on with an external switch, it switches to higher speed 0 to 150 s after switch activation. After turning the fan off it continues running at higher speed within 2 to 30 minutes and then reverts to the previous mode. The fan run-out time and delay time for higher speed are regulated with the internal regulator.
- Interval switch (Valeo...I)**
Depending on wiring connection the fan is off or runs permanently at low speed. In interval mode regulated from 0.5 to 15 hours the fan switches periodically to higher speed for 10 minutes. The switch interval is adjusted with the internal regulator. If the light in the room is turned on, the fan switches to higher speed in 50 s. After light is off the fan reverts to the interval mode operation.
- Humidity sensor (Valeo...H)**
Depending on wiring connection the fan is off or runs permanently at low speed. The fan switches to higher speed as relative humidity in the room increases from 60 % up to 90 % and switches off as humidity drops by 10 % below the set level. If the light in the room is turned on, the fan switches to higher speed in 50 s. The run-out time is set by the internal regulator from 2 to 30 minutes.

Designation key

Series	Air capacity according to speed	Option
Valeo	35/60; 75/100	K: fire damper T: timer TR: regulated timer I: interval switch H: humidity sensor

Accessories

Filters	Speed controllers	Flexible ducts	Clamps
 FP-Valeo	 CDP	 BlauFlex AN	 K

Plastic mounting casing

- BP 80: plastic casing for flush mounting.
- Made of quality ABS plastic and equipped with a gravity backdraft damper.
- Installed in a wall or ceiling during general construction works by mounting brackets supplied as a standard.
- The casing is equipped with oblong slotted joints to facilitate mounting.
- Connection to the main ventilation shaft with flexible air ducts.
- Exhaust spigot diameter 80 mm.
- After installation works cover the unit with a protecting cover to prevent dirt ingress.
- After finishing works install the Valeo unit inside the casing.
- For exhaust ventilation of neighbour rooms additional spigots may be connected to the casing.



Gravity backdraft damper

Mounting example

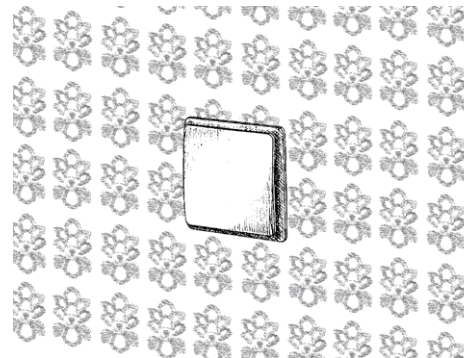
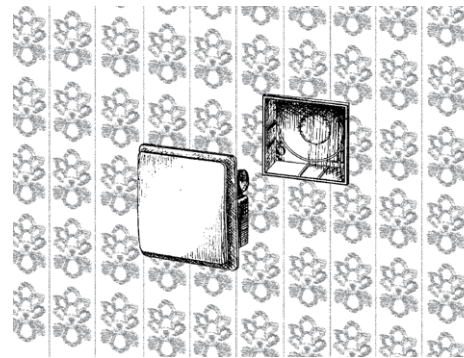
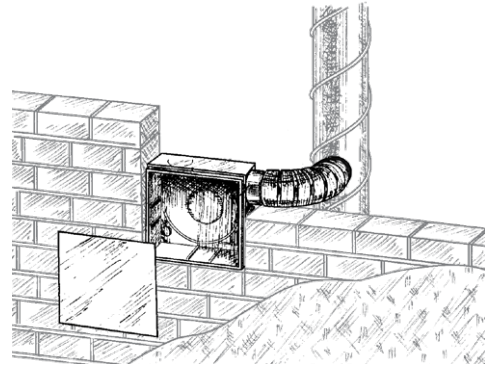

Mounting fireproof casing

- **BF 80**: fireproof casing for flush mounting.
- Made of silicate plates based on calcium silicate and has high thermal insulating properties.
- Equipped with a fire-retarding damper to prevent fire and smoke expanding along air ducts. If temperature in the duct reaches 90°C the thermal fuse closes the damper.
- When the fan is off, the fire-retarding damper serves as a backdraft damper.
- The fan casing is installed in a wall or ceiling during general construction works by mounting brackets supplied as a standard.
- Connection to the main ventilation shaft with flexible air ducts. Exhaust spigot diameter 80 mm.
- Power is supplied to the fan through a sealed electric lead-in on the casing.
- After installation works cover the unit with a protecting cover to prevent dirt ingress.
- After finishing works install the ventilation unit inside the casing and connect it to the wiring system.
- For exhaust ventilation of neighbour rooms extra spigots may be connected to the casing on the left (**BFL** modification), on the right (**BFR** modification), on the bottom (**BFD** modification).



Mounting example

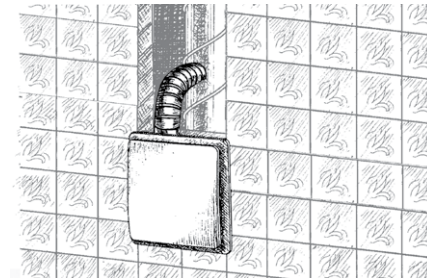
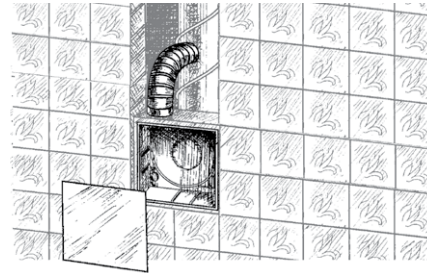
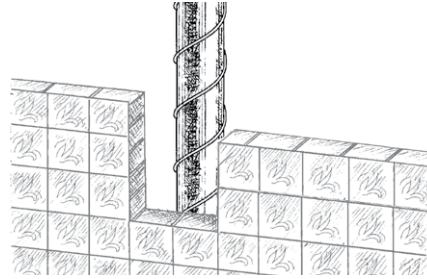

BFL 80



BFR 80



Fire-retarding damper



BFD 80

Overall dimensions [mm]

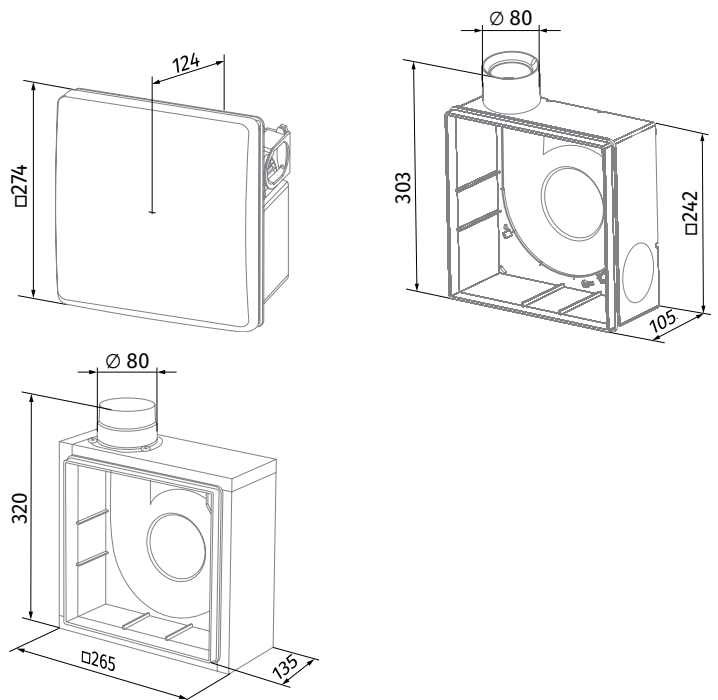

Technical data

Model	Valeo 35/60	Valeo 75/100
Speed	I / II	I / II
Voltage [V/Hz]	220-240/50	220-240/50
Power [W]	15 / 25	24 / 29
Current [A]	0.12 / 0.14	0.11 / 0.13
Cable cross section [mm ²]	3x1.5	3x1.5
Maximum air flow [m ³ /h (l/s)]	35 (10) / 63 (18)	75 (21) / 100 (28)
Sound pressure level [dBA]*	27 / 36	29 / 38
Max. transported air temperature [°C]	+50	+50
IP rating	IP55	IP55

* Sound pressure level measured in free space at a distance of 3 meters from the fan.

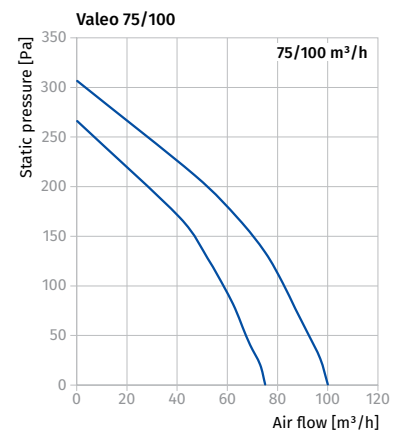
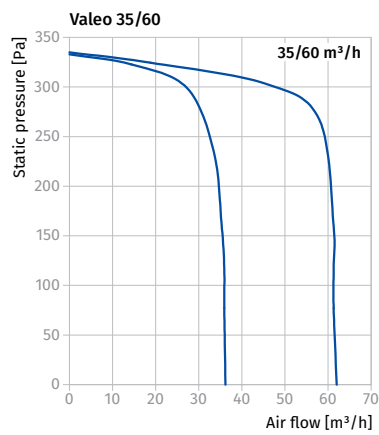

- The abrupt curves show high pressure performance and constant air flow of several **Valeo** fans integrated into a single ventilation shaft.

Calculation of basic ventilation shaft diameter for mono-pipe ventilation systems

- The charts below display dependence of ventilation shaft dimensions as a function of number of storeys in high-rise buildings with a mono-pipe ventilation system.

VENTILATION OF BATHROOMS OR TOILETS AT THE CALCULATED AIR FLOW RATE OF 60 M³/H

- One fan per each floor, rated air flow 60 m³/h for full operation mode of all fans.

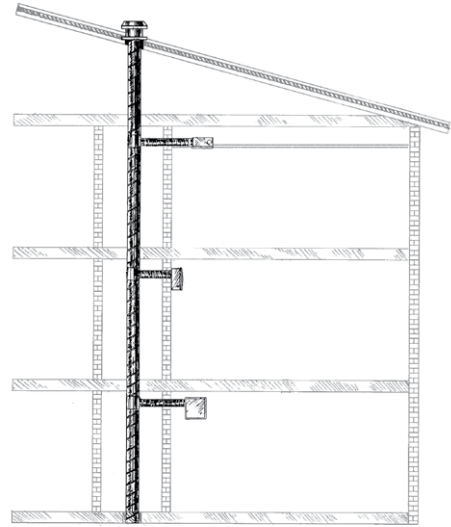
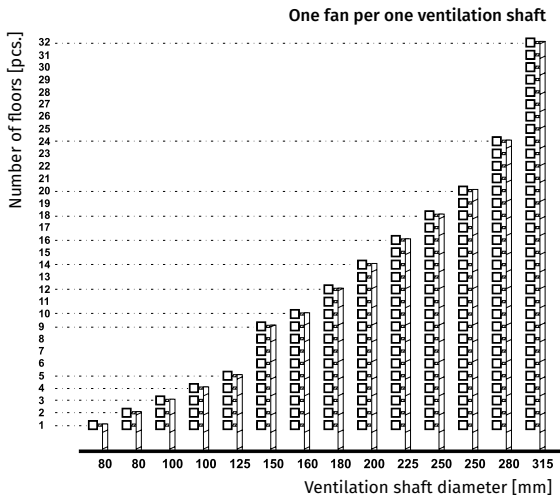

- Two fans per each floor, rated air flow 60 m³/h for full operation mode of all the fans.

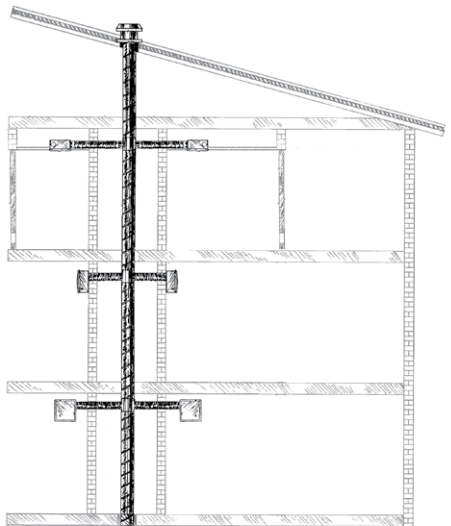
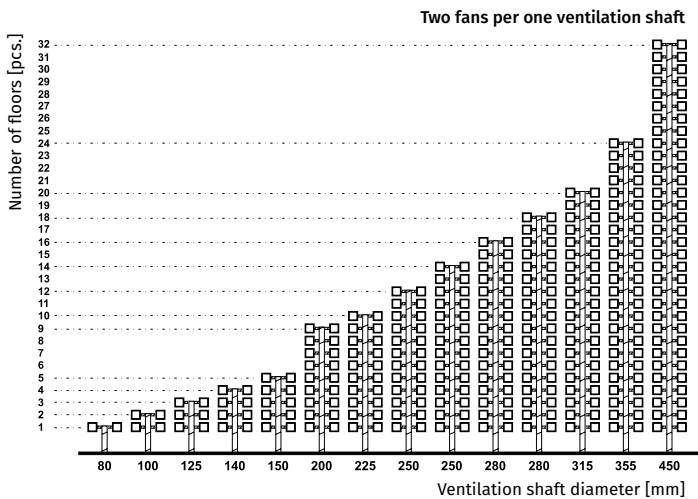

EXHAUST FANS FOR MONO-PIPE VENTILATION

Calculation of basic ventilation shaft diameter for mono-pipe ventilation systems

- The charts below display dependence of ventilation shaft dimensions as a function of number of storeys in high-rise buildings with a mono-pipe ventilation system.

VENTILATION OF KITCHENS OR SIMULTANEOUS VENTILATION OF TWO SPACES AT THE CALCULATED AIR FLOW RATE OF 100 M³/H

- One fan per each floor, rated air flow for kitchen 100 m³/h for full operation mode of all fans.
- For synchronous room-to-room ventilation: 60 m³/h for bathroom and 40 m³/h for WC.

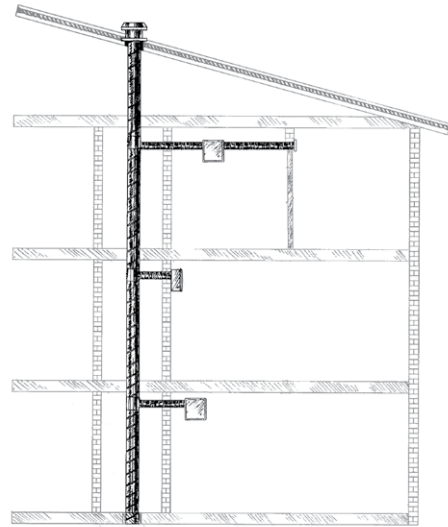
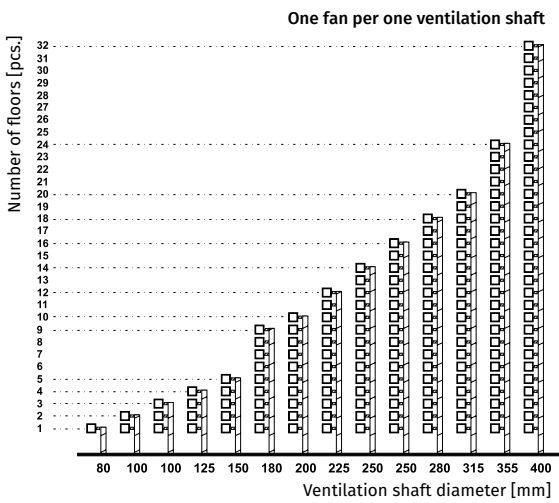

- Two fans per each floor, rated air flow for kitchen 100 m³/h for full operation mode of all the fans.
- For synchronous room-to-room ventilation: 60 m³/h for bathroom and 40 m³/h for WC.

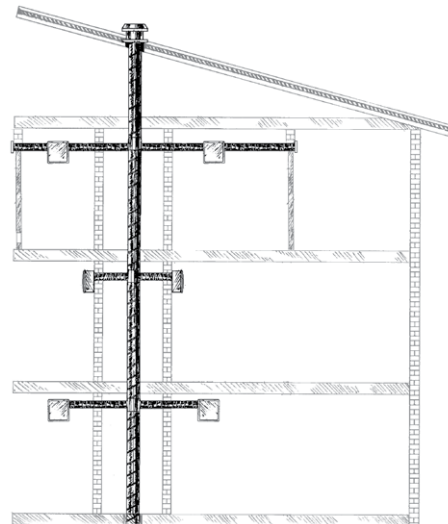
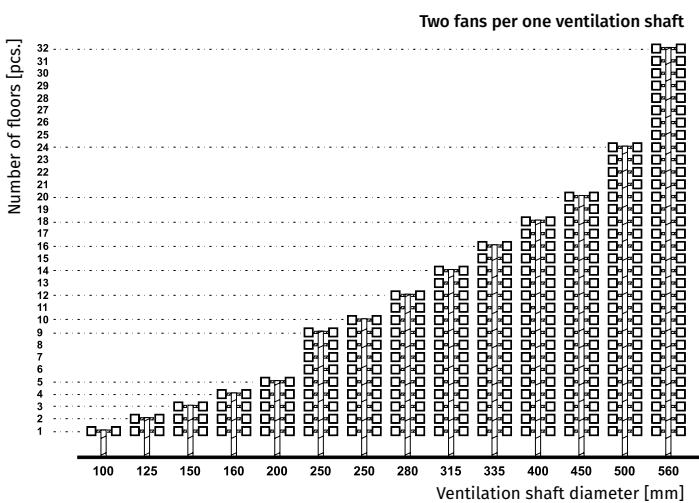

Valeo-BP

Mono-pipe ventilation exhaust centrifugal fans

Use

- Exhaust ventilation systems installed in high-rise buildings and premises.
- Mono-pipe ventilation systems.
- For mounting in kitchens and bathrooms.
- Flush wall or ceiling mounting.



Air flow:
up to 100 m³/h
28 l/s



Power:
from 15 W



Noise level:
from 27 dBA



Design

- The fan consists of the plastic casing **BP** for flush mounting and exhaust ventilation unit **Valeo** with a flat front panel.
- The casing is made of durable ABS plastic and fitted with a gravity back-draft damper to prevent backdraft.



- The front panel is made of snow white UV-resistant plastic.
- G4 purifying durable filter protects the motor, impeller and ductwork system against soiling.
- The filter is easily accessible for service operations.
- Due to modern design and various colour modifications the front panel matches well with any interior.
- The casing is equipped with oblong slotted joints to facilitate mounting of the casing in true vertical position.
- If the casing is installed with some vertical deviations, the special turnable grille conceals possible mounting inaccuracies.
- Power is supplied to the fan through a sealed electric lead-in on the casing and the ventilation unit is equipped with an airtight terminal block for connection to the wiring system.
- For room-to-room ventilation some ventilation unit modifications are equipped with extra spigots: **Valeo-BPL** – on the left; **Valeo-BPR** – on the right; **Valeo-BPD** – on the bottom.
- Ingress protection rating IP55.

Motor

- Two-speed motor with a centrifugal impeller. Minimum energy demand.
- The impeller has forward curved blades.
- Automatic maintaining of constant air flow depending on variable air resistance of the duct.
- Balanced impeller ensures low noise operation.
- Best aerodynamic characteristics due to a special scroll casing design.
- Ball bearings provide long service life.
- The ventilation unit with the motor is fixed inside the casing with special latches.





Speed control

- Step speed control with an external speed controller, e.g. a **CDP-3/5** model which is available upon order.
- Wide range of intellectual controls programmable by set parameters (timer, adjustable timer, internal switch, photo sensor, humidity sensor).

Designation key

Series	Air capacity according to speed	Option
Valeo-BP	35/60; 75/100	K: fire damper T: timer TR: regulated timer I: interval switch H: humidity sensor

Accessories

Filters	Speed controllers	Flexible ducts	Clamps
 FP-Valeo	 CDP	 BlauFlex AN	 K

Options

o Timer (Valeo-BP...T)

Depending on wiring connection the fan is off or runs permanently at low speed. The fan is turned to higher speed with an external switch 50 s after activation. After turning the switch off the fan continues operating within 6 min at higher speed and then reverts to default operation mode.

o Adjustable timer (Valeo-BP...TR)

Depending on wiring connection the fan is off or runs permanently at low speed. If the fan is turned on with an external switch, it switches to higher speed 0 to 150 s after switch activation. After turning the fan off it continues running at higher speed within 2 to 30 minutes and then reverts to the previous mode. The fan run-out time and delay time for higher speed are regulated with the internal regulator.

o Interval switch (Valeo-BP...I)

Depending on wiring connection the fan is off or runs permanently at low speed. In interval mode regulated from 0.5 to 15 hours the fan switches periodically to higher speed for 10 minutes. The switch interval is adjusted with the internal regulator. If the light in the room is turned with the external switch, the fan switches to higher speed in 50 s. After light is off the fan reverts to the interval mode operation.

o Humidity sensor (Valeo-BP...H)

Depending on wiring connection the fan is off or runs permanently at low speed. The fan switches to higher speed as relative humidity in the room increases from 60 % up to 90 % and switches off as humidity drops by 10 % below the set level. If the light in the room is turned on, the fan switches to higher speed in 50 s. The run-out time is set by the internal regulator from 2 to 30 minutes.

Mounting

- o Installed in a wall or ceiling during general construction works by mounting brackets supplied as a standard.
- o Connection to the main ventilation shaft with flexible air ducts.
- o For exhaust ventilation of a neighbour room remove a plug and install an additional spigot. Available upon separate order.
- o Exhaust spigot diameter 80 mm.
- o Power is supplied to the fan through a sealed electric lead-in on the casing.
- o After installation works cover the unit with a protecting cover to prevent dirt ingress.
- o After finishing works install the ventilation unit inside the casing and connect it to the wiring system.

Mounting example

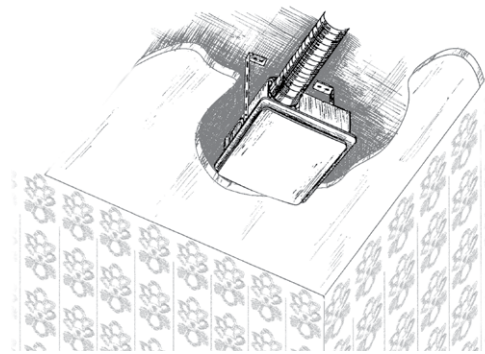

Overall dimensions [mm]

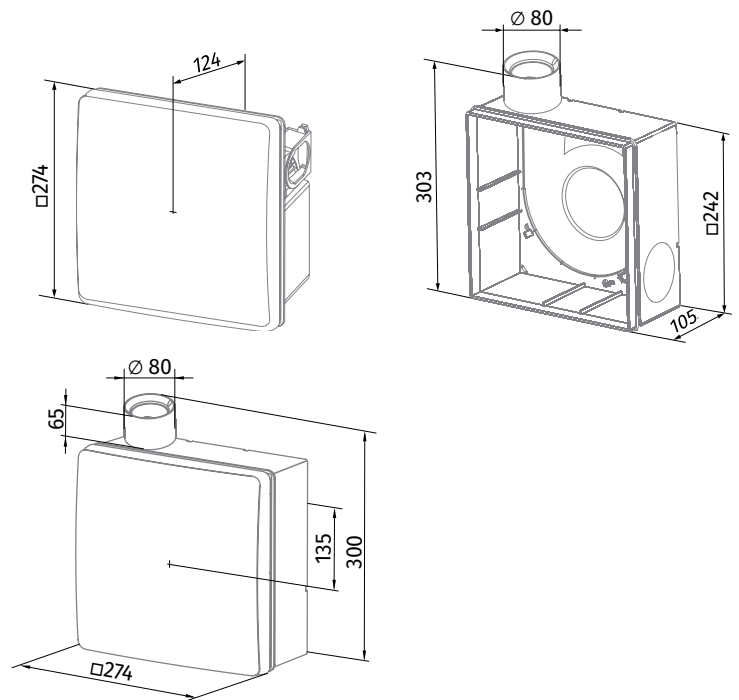

Technical data

Model	Valeo-BP 35/60	Valeo-BP 75/100
Speed	I / II	I / II
Voltage [V/Hz]	220-240/50	220-240/50
Power [W]	15 / 25	24 / 29
Current [A]	0.12 / 0.14	0.11 / 0.13
Cable cross section [mm ²]	3x1.5	3x1.5
Maximum air flow [m ³ /h (l/s)]	35 (10) / 63 (18)	75 (21) / 100 (28)
Sound pressure level [dBA]*	27 / 36	29 / 38
Max. transported air temperature [°C]	+50	+50
IP rating	IP55	IP55

* Sound pressure level measured in free space at a distance of 3 meters from the fan.

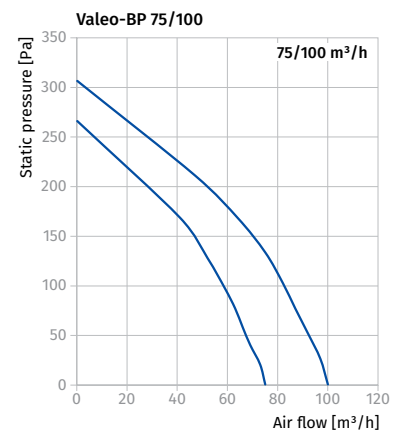
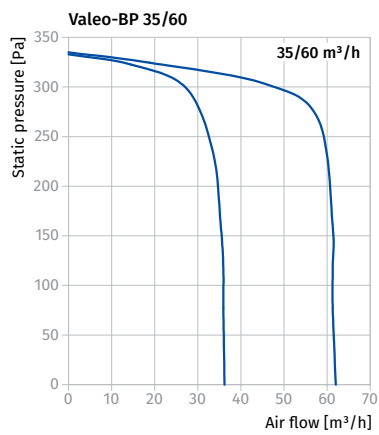

- The abrupt curves show high pressure performance and constant air flow of several **Valeo-BP** fans integrated into a single ventilation shaft.

High-rise mono-pipe ventilation system arrangement example

- The mechanical centralized mono-pipe exhaust ventilation system for kitchens and bathrooms based on Valeo-BP fans is specially designed for high-rise residential premises.
- Fresh air is supplied to bedrooms, children's room or living rooms through windows or wall vents. Vent modifications with air volume regulation are available.

- Stale air is extracted from the room by the extract fans through the inside doors or door grilles in the kitchen, bathroom or WC.
- This ventilation system arrangement ensures non-stop controllable air circulation in the room, comfortable microclimate and high fire safety.

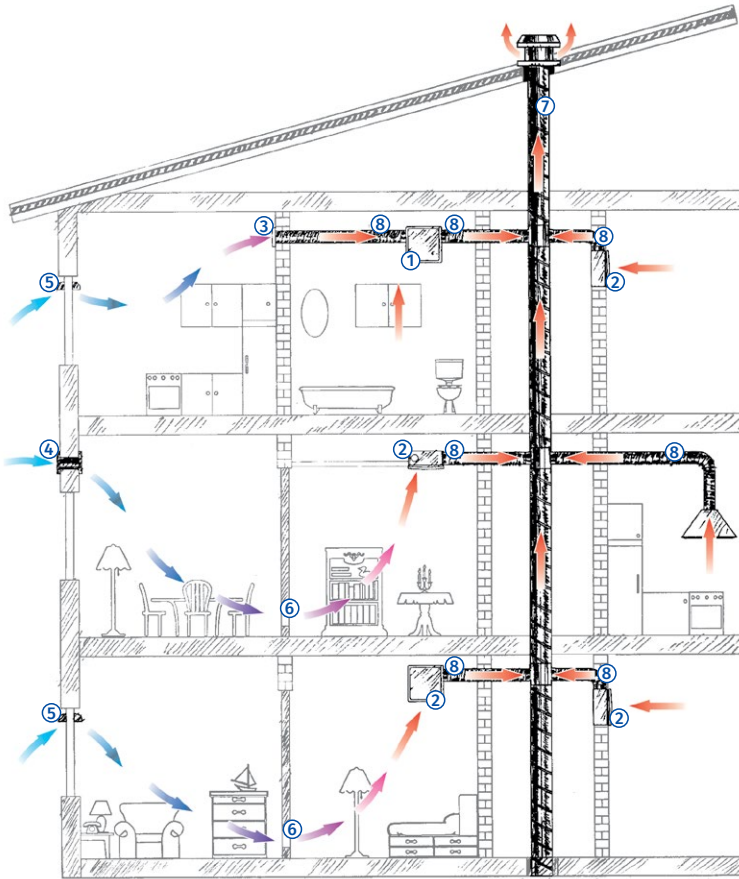

- 1 - Extract fan **Valeo-BPD** with an additional spigot for - room-to-room ventilation.
- 2 - Extract fan **Valeo-BP**.
- 3 - BLAUBERG wall grille, **DECOR** series.
- 4 - BLAUBERG wall vent, **WHM** series.
- 5 - BLAUBERG window vent, **FHM** series.
- 6 - BLAUBERG ventilation door grilles, **DECOR** series.
- 7 - Central ventilation shaft.
- 8 - Flexible air ducts for connection of extract fans to the central ventilation shaft, e.g. BLAUBERG air ducts, **BlauFlex** series.

Valeo-BF

Mono-pipe ventilation exhaust centrifugal fans

Use

- Exhaust ventilation systems installed in high-rise buildings and premises.
- For buildings with a mono-pipe ventilation system.
- For mounting in kitchens and bathrooms.
- Surface wall or ceiling mounting.



Air flow:
up to 100 m³/h
28 l/s



Power:
from 15 W



Noise level:
from 27 dBA



Design

- The fan consists of the fireproof casing BF for flush mounting and exhaust ventilation unit Valeo with a flat front panel.
- The casing is made of silicate plates based on calcium silicate and has high thermal insulating properties.
- Equipped with a fire-retarding damper to prevent fire and smoke expanding along air ducts. If temperature in the duct reaches 90 °C the thermal fuse melts and closes the damper.



- When the fan is off the fire-retarding damper serves as a backdraft damper.
- The front panel is made of snow white UV-resistant plastic.
- Filter with filter class **G4** for motor, impeller and ductwork system protection against soiling.
- The filter is easily accessible for service operations.
- Due to modern design and various colour modifications the front panel matches well with any interior.
- The casing is equipped with oblong slotted joints to facilitate mounting of the casing in true vertical position

- If the casing is installed with some vertical deviations, the special turnable grille conceals possible mounting inaccuracies.
- Power is supplied to the fan through a sealed electric lead-in on the casing and the ventilation unit is equipped with an airtight terminal block for connection to the wiring system.
- For room-to-room ventilation some ventilation unit modifications are equipped with extra spigots: **Valeo-BFL** – on the left; **Valeo-BFR** – on the right; **Valeo-BFD** – on the bottom.
- Ingress protection rating IP55.

Motor

- Two-speed motor with a centrifugal impeller. Minimum energy demand.
- The impeller has forward curved blades.
- Automatic maintaining of constant air flow depending on variable air resistance of the duct.
- Balanced impeller ensures low-noise operation.
- Best aerodynamic characteristics due to a special scroll casing design.
- Ball bearings provide long service life.
- The ventilation unit with the motor is fixed inside the casing with special latches.





Speed control

- Step speed control with an external speed controller, e.g. a **CDP-3/5** model which is available upon order.
- Wide range of intellectual controls programmable by set parameters (timer, adjustable timer, internal switch, humidity sensor).

Designation key

Series	Air capacity according to speed	Option
Valeo-BF	35/60; 75/100	T: timer
Valeo-BFL		TR: regulated timer
Valeo-BFR		I: interval switch
Valeo-BFD		H: humidity sensor

Accessories

Filters	Speed controllers	Flexible ducts	Clamps
 FP-Valeo	 CDP	 BlauFlex AN	 K

Options

o Timer (Valeo-BF...T)

Depending on wiring connection the fan is off or runs permanently at low speed. The fan is turned to higher speed with an external switch 50 s after activation. After turning the switch off the fan continues operating within 6 min at higher speed and then reverts to default operation mode.

o Adjustable timer (Valeo-BF...TR)

Depending on wiring connection the fan is off or runs permanently at low speed. If the fan is turned on with an external switch, it switches to higher speed 0 to 150 s after switch activation. After turning the fan off it continues running at higher speed within 2 to 30 minutes and then reverts to the previous mode. The fan run-out time and delay time for higher speed are regulated with the internal regulator.

o Interval switch (Valeo-BF...I)

Depending on wiring connection the fan is off or runs permanently at low speed. In interval mode regulated from 0.5 to 15 hours the fan switches periodically to higher speed for 10 minutes. The switch interval is adjusted with the internal regulator. If light in the room is turned with the external switch, the fan switches to higher speed in 50 s. After light is off the fan reverts to the interval mode operation.

o Humidity sensor (Valeo-BF...H)

Depending on wiring connection the fan is off or runs permanently at low speed. The fan switches to higher speed as relative humidity in the room increases from 60 % up to 90 % and switches off as humidity drops by 10 % below set level. If light in the room is turned on, the fan switches to higher speed in 50 s. The run-out time is set by the internal regulator from 2 to 30 minutes.

Mounting

- o Installed in a wall or ceiling during general construction works by mounting brackets supplied as a standard.
- o Connection to main ventilation shaft with flexible air ducts.
- o Exhaust spigot diameter 80 mm.
- o Power is supplied to the fan through a sealed electric lead-in on the casing.
- o After installation works cover the unit with a protecting cover to prevent dirt ingress.
- o After finishing works install the ventilation unit inside the casing and connect it to the wiring system.

Mounting example

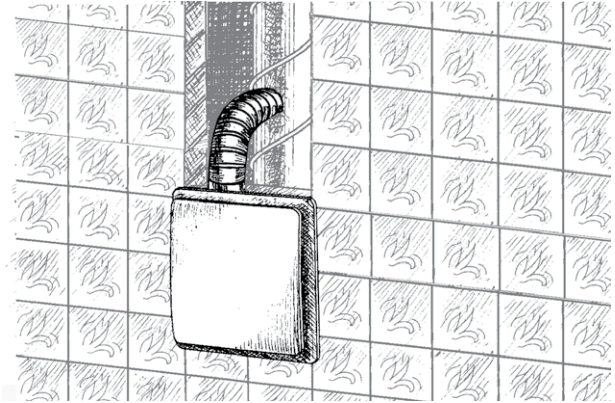

Overall dimensions [mm]

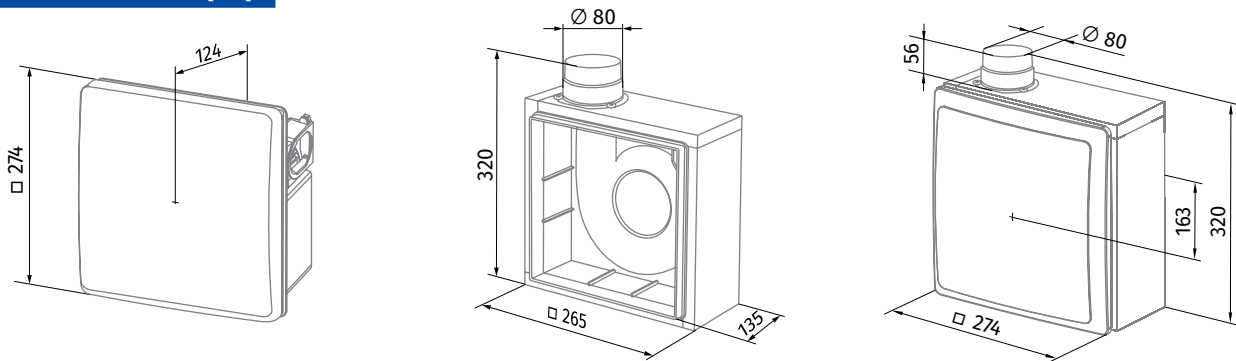

Technical data

Model	Valeo-BF 35/60	Valeo-BF 75/100
Speed	I / II	I / II
Voltage [V/Hz]	220-240/50	220-240/50
Power [W]	15 / 25	24 / 29
Current [A]	0.12 / 0.14	0.11 / 0.13
Cable cross section [mm ²]	3x1.5	3x1.5
Maximum air flow [m ³ /h (l/s)]	35 (10) / 63 (18)	75 (21) / 100 (28)
Sound pressure level [dBA]*	27 / 36	29 / 38
Max. transported air temperature [°C]	+50	+50
IP rating	IP55	IP55

* Sound pressure level measured in free space at a distance of 3 meters from the fan.

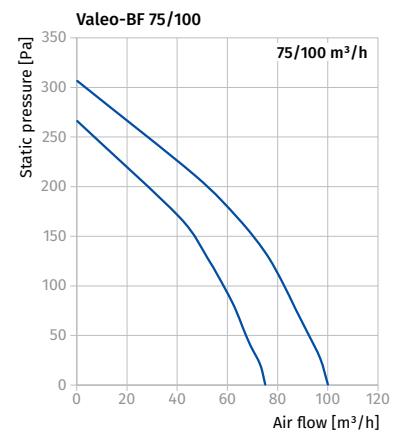
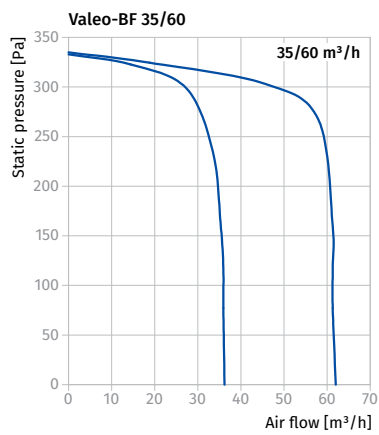

- The abrupt curves show high pressure performance and constant air flow of several **Valeo-BF** fans integrated into a single ventilation shaft.

High-rise mono-pipe ventilation system arrangement example

- The mechanical centralized mono-pipe exhaust ventilation system for kitchens and bathrooms based on **Valeo-BF** fans in fireproof casing with fire-retarding damper is specially designed for high-rise residential premises with high fire safety requirements. The inter-floor fire dampers are installed in the ventilation shaft to prevent fire and smoke extension in case of fire.
- Fresh air is supplied to bedrooms, children's room or living rooms through windows or wall vents. Vent modifications with air volume regulation are available.
- Stale air is extracted from the room by the extract fans through inside the doors or door grilles in the kitchen, bathroom or WC.
- This ventilation system arrangement ensures non-stop controllable air circulation in the room, comfortable microclimate and high fire safety.

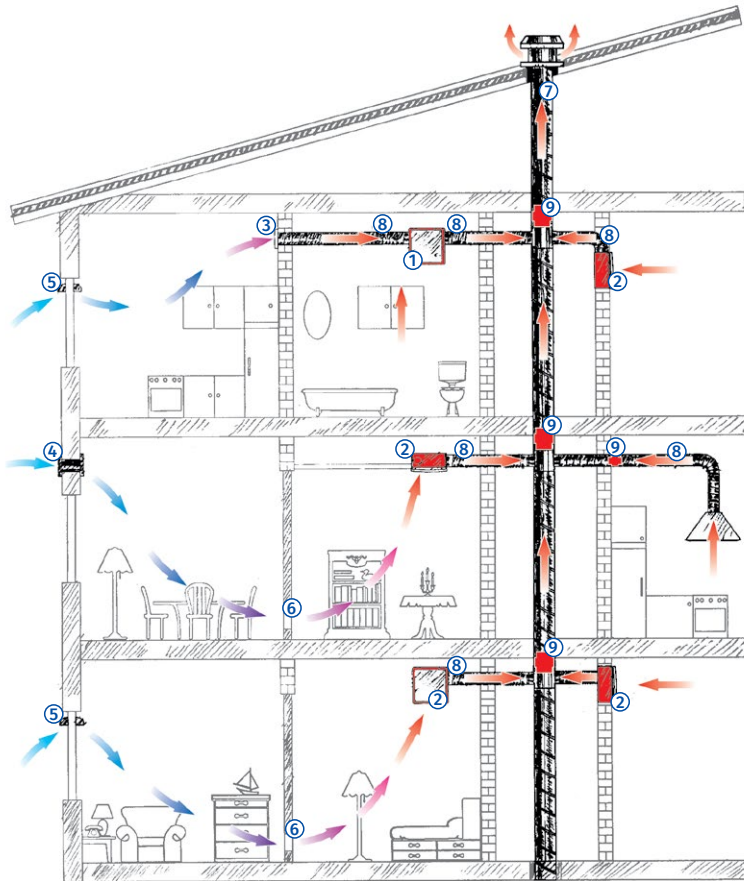

- 1 – Extract fan **Valeo-BFD** with an additional spigot for room-to-room ventilation.
- 2 – Extract fan **Valeo-BF**.
- 3 – BLAUBERG wall grille, **DECOR** series.
- 4 – BLAUBERG wall vent, **WMH** series.
- 5 – BLAUBERG window vent, **FHM** series.
- 6 – BLAUBERG ventilation door grilles, **DECOR** series.
- 7 – Central ventilation shaft.
- 8 – Flexible thermal-resistant air ducts for connection of extract fans to the central ventilation shaft.
- 9 – Inter-floor fire damper.

Valeo-E

Mono-pipe ventilation exhaust centrifugal fans

Use

- Exhaust ventilation systems installed in high-rise buildings and premises.
- For buildings with a mono-pipe ventilation system.
- For mounting in kitchens and bathrooms.
- Surface wall or ceiling mounting.



Air flow:
up to 100 m³/h
28 l/s



Power:
from 15 W



Noise level:
from 27 dBA



Design

- The fan consists of a plastic casing for surface mounting and an exhaust ventilation unit **Valeo** with a flat front panel.
- The casing is made of durable ABS plastic and fitted with a gravity back-draft damper to prevent backdrafting.



- The front panel is made of snow-white UV-resistant plastic.
- Filter with filter class G4 for motor, impeller and ductwork system protection against soiling.
- The filter is easily accessible for service operations.
- Due to modern design and various colour modifications the front panel matches well with any interior.
- The casing is equipped with oblong slotted joints to facilitate mounting of the casing in true vertical position.
- Power is supplied to the fan through a sealed electric lead-in on the casing and the ventilation unit is equipped with an airtight terminal block for connection to the wiring system.
- Exhaust spigot diameter 80 mm.
- Ingress protection rating IP55.

Motor

- Two-speed motor with a centrifugal impeller. Minimum energy demand.
- The impeller has forward curved blades.
- Automatic maintaining of constant air flow depending on variable air resistance of the duct.
- Balanced impeller ensures low noise operation.
- Best aerodynamic characteristics due to a special scroll casing design.
- Ball bearings provide long service life.
- The ventilation unit with a motor is fixed inside the casing with special latches.





Speed control

- Step speed control with an external speed controller, e.g. a **CDP-3/5** model which is available upon order.
- Wide range of intellectual controls programmable by set parameters (timer, adjustable timer, internal switch, photo sensor, humidity sensor).

Designation key

Series	Air capacity according to speed	Option
Valeo-E	35/60; 75/100	K: fire damper T: timer TR: regulated timer I: interval switch H: humidity sensor

Accessories

Filters	Speed controllers	Flexible ducts	Clamps
 FP-Valeo	 CDP	 BlauFlex AN	 K

Options

o Timer (Valeo-E...T)

Depending on wiring connection the fan is off or runs permanently at low speed. The fan is turned to higher speed with an external switch 50 s after activation. After turning the switch off the fan continues operating within 6 min at higher speed and then reverts to default operation mode.

o Adjustable timer (Valeo-E...TR)

Depending on wiring connection the fan is off or runs permanently at low speed. If the fan is turned on with an external switch, it switches to higher speed 0 to 150 s after switch activation. After turning the fan off it continues running at higher speed 2 to 30 minutes and then reverts to the previous mode. The fan run-out time and delay time for higher speed are regulated with the internal regulator.

o Interval switch (Valeo-E...I)

Depending on wiring connection the fan is off or runs permanently at low speed. In interval mode regulated from 0.5 to 15 hours the fan switches periodically to higher speed for 10 minutes. The switch interval is adjusted with the internal regulator. If the light in the room is turned with the external switch, the fan switches to higher speed in 50 s. After light is off the fan reverts to the interval mode operation.

o Humidity sensor (Valeo-E...H)

Depending on wiring connection the fan is off or runs permanently at low speed. The fan switches to higher speed as relative humidity in the room increases from 60 % up to 90 % and switches off as humidity drops by 10 % below the set level. If the light in the room is turned on, the fan switches to higher speed in 50 s. The run-out time is set by the internal regulator from 2 to 30 minutes.

Mounting

- o Flexible air ducts connected to the ductwork system and wiring are routed to the fan through the wall or ceiling.
- o After finishing works a flexible air duct is fixed on the fan spigot with clamps.
- o Power is supplied to the fan through a sealed electric lead-in on the casing.
- o The casing is installed at site with dowels and is adjusted vertically with oblong slotted joints.
- o The ventilation unit connected to the wiring system is installed in the mounted and fixed casing.

Mounting example

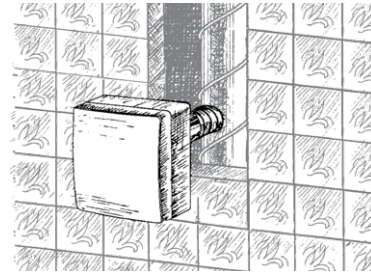

Overall dimensions [mm]

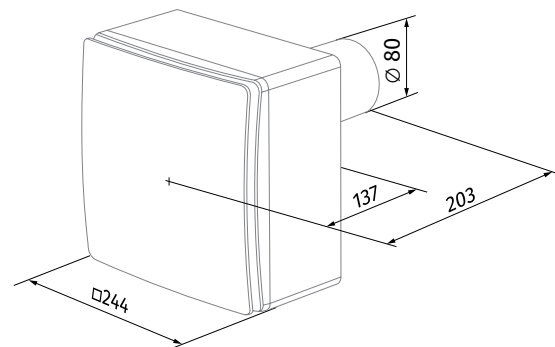

Technical data

Model	Valeo-E 35/60	Valeo-E 75/100
Speed	I / II	I / II
Voltage [V/Hz]	220-240/50	220-240/50
Power [W]	15 / 25	24 / 29
Current [A]	0.12 / 0.14	0.11 / 0.13
Cable cross section [mm ²]	3x1.5	3x1.5
Maximum air flow [m ³ /h (l/s)]	35 (10) / 63 (18)	75 (21) / 100 (28)
Sound pressure level [dBA]*	27 / 36	29 / 38
Max. transported air temperature [°C]	+50	+50
IP rating	IP55	IP55

* Sound pressure level measured in free space at a distance of 3 meters from the fan.

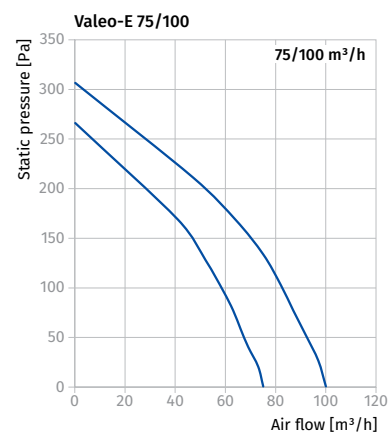
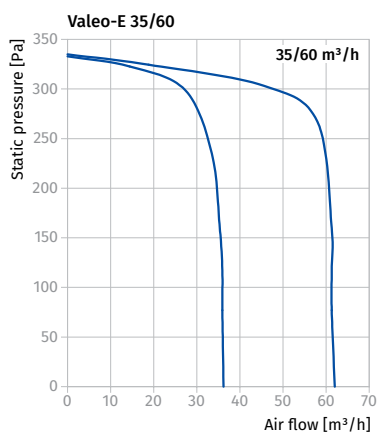

- The abrupt curves show high pressure performance and constant air flow of several **Valeo-E** fans integrated into a single ventilation shaft.

High-rise mono-pipe ventilation system arrangement example

- The mechanical centralized mono-pipe exhaust ventilation system for kitchens and bathrooms based on **Valeo-E** fans is specially designed for high-rise residential premises.
- Fresh air is supplied to bedrooms, children's room or living rooms through windows or wall vents. Vent modifications with air volume regulation are available.
- Stale air is extracted from the room by the extract fans through the inside doors or door grilles in the kitchen, bathroom or WC.
- This ventilation system arrangement ensures non-stop controllable air circulation in the room, comfortable microclimate and high fire safety.

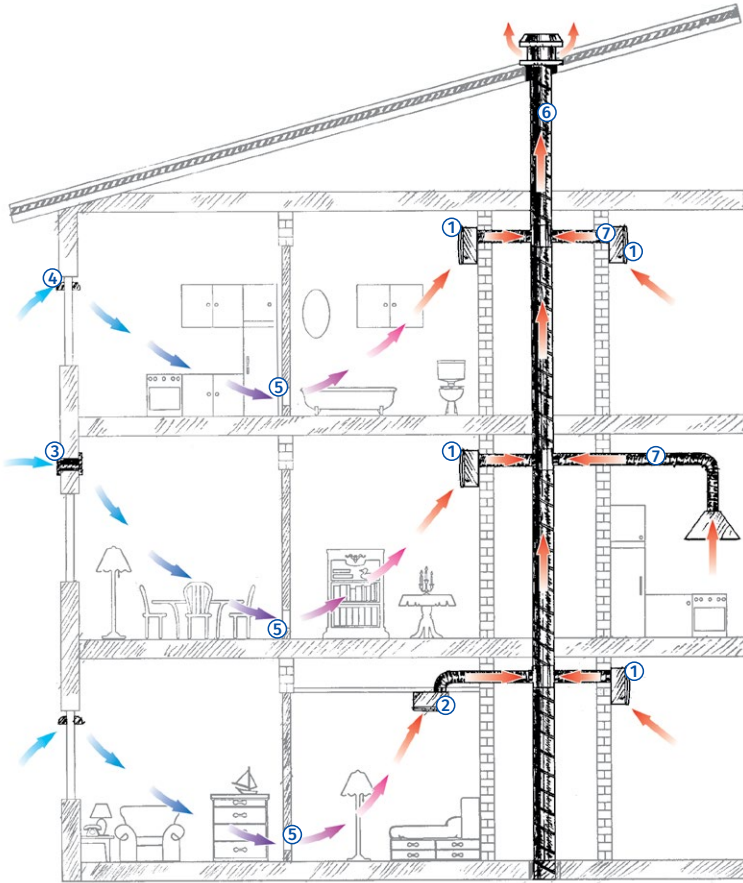

- 1 - Extract fan **Valeo-E** (surface mounting).
- 2 - Extract fan **Valeo-E** (ceiling mounting).
- 3 - BLAUBERG wall vent, **WMH** series.
- 4 - BLAUBERG window vent, **FHM** series.
- 5 - BLAUBERG ventilation grilles, **DECOR** series.
- 6 - Central ventilation shaft.
- 7 - Flexible air ducts for connection of extract fans to the central ventilation shaft, e.g. BLAUBERG air ducts, **Blauflex** series.

MRDL / MRIDL

Mounting frames

Use

- For facilitation of mounting and installation of **Tower-H, Tower-V, Tower-H EC, Tower-V EC, Tower-A, Tower-AL** roof fans on the flat roof.
- Prevents water ingress inside a ventilation shaft or air duct.



Design

- Mounting frames in standard (**MRDL** model) or sound-insulated modifications (**MRIDL** model).
- The casing is made of galvanized steel.
- MRIDL** models are equipped with 20 mm heat- and sound-insulated mineral wool layer.
- Specially designed flanges on the frame bottom enable easy and reliable mounting on the roof.
- The casing has threaded openings for fastening of the fan with bolts.
- Size 630-1100 is equipped with a detachable bolted panel for mounting facilitation.

Mounting

- Fixing on the roof with flanges in the bottom with subsequent extra insulation.
- The fan is attached to the roof frame with bolts.

Overall dimensions [mm]

Type	Standard size of compatible fans	B	B1	H	L	L1	Weight [kg]
MRDL 200-225	190, 220, 225	720	254	300.5	301	245	10.4
MRDL 250-315	250, 280, 310	810	352	300.5	401	330	12.0
MRDL 355-400	355, 400	980	506	300.5	561	450	16.4
MRDL 450-500	450, 500	997	576	300.5	631	535	16.9
MRDL 560	560	1180	770	300.5	817	750	26.7
MRDL 630	630	1212	852	600.0	912	750	65.9
MRDL 710, 800	710, 800	1262	902	600.0	962	840	68.5
MRDL 900	900	1512	1152	650.0	1212	1050	85.7
MRDL 1000, 1100	1000, 1100	1712	1352	730.0	1412	1240	103.7

Type	Standard size of compatible fans	B	B1	H	L	L1	Weight [kg]
MRIDL 200-225	190, 220, 225	720	254	300.5	301	245	13.8
MRIDL 250-315	250, 280, 310	810	352	300.5	401	330	16.9
MRIDL 355-400	355, 400	980	506	300.5	561	450	20.3
MRIDL 450-500	450, 500	997	576	300.5	631	535	21.2
MRIDL 560	560	1180	770	300.5	817	750	35.7
MRIDL 630	630	1212	850	600.0	912	750	85.5
MRIDL 710, 800	710, 800	1262	900	600.0	962	840	89.0
MRIDL 900	900	1512	1150	650.0	1212	1050	113.0
MRIDL 1000, 1100	1000, 1100	1712	1350	730.0	1412	1240	140.6

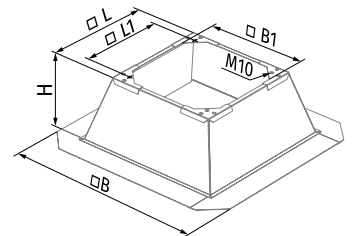

MRDL 200-225 – MRDL 560
MRIDL 200-225 – MRIDL 560

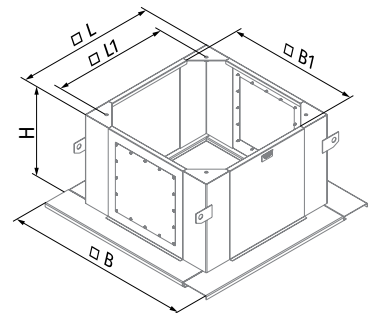

MRDL 630 – MRDL 1000-1100

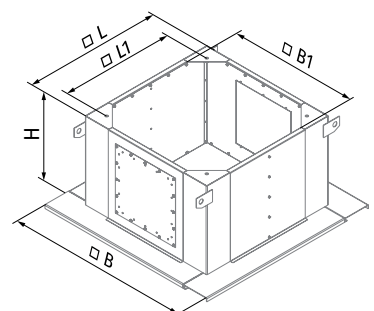

MRIDL 630 – MRIDL 1000-1100

KDL

Backdraft dampers

Use

- For automatic shutoff of air ducts when the fan is off.
- Backdraft prevention when mechanical ventilation is off.
- Compatible with **Tower-H, Tower-V, Tower-H EC, Tower-V EC** roof fans.



Design

- The casing and the rotary blade are made of galvanized steel.
- Gravity actuated damper (the damper rotary blade is opened by air pressure and reset automatically when the fan is off and no air pressure is produced).
- The damper is equipped with the flanges for connection to the roof fan, the **VDL** flexible connector or the **FDL** counterflange.

Overall dimensions [mm]

Type	Standard size of compatible fans	∅ D	∅ D1	∅ D2	∅ d	H	Weight [kg]
KDL 220-225	190, 220, 225	183	213	235	7	115	1.0
KDL 250-315	250, 280, 310	256	285	306	7	156	1.7
KDL 355-500	355, 400, 450, 500	402	438	464	9	220	3.5
KDL 560	560, 630	565	605	638	10	300	7.3
KDL 710	710	635	674	708	10	380	14.1

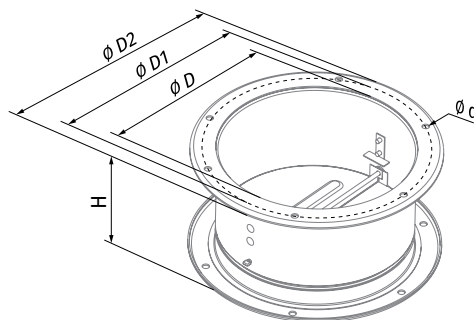

VDL

Flexible connectors for roof fans

Use

- Absorbing vibration from the fan to the air duct.
- Partial thermal distortion compensation in the air ductworks.
- For mounting with the **Tower-H**, **Tower-V**, **Tower-H EC**, **Tower-V EC** roof fans.



Design

- Consists of two flanges interconnected with a vibration-absorbing material.
- The flanges made of galvanized steel.
- The connecting vibration-isolating material is made of nylon reinforced polyethylene fabric.

Mounting

- The end flanges of the flexible connector are fixed to the mating flanges of the air duct or fan (**FDL** counterflange) or to the backdraft damper through galvanized bolts and clamps.

Overall dimensions [mm]

Type	Standard size of compatible fans	∅ D	∅ D1	∅ D2	∅ d	L	Weight [kg]
VDL 220-225	190, 220, 225	183	210	235	7	200	0.8
VDL 250-315	250, 280, 310	256	285	308	7	200	1.2
VDL 355-500	355, 400, 450, 500	402	430	484	9	200	1.75
VDL 560	560, 630	567	605	639	9	200	2.62
VDL 710	710	630	674	705	10	40	7.1

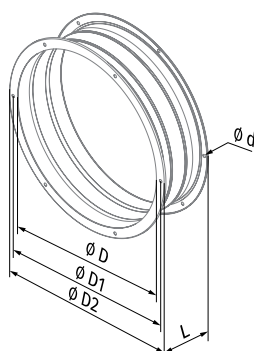

FDL

Counterflanges for roof fans

Use

- o Connection of round air ducts with the **Tower-H, Tower-V, Tower-H EC, Tower-V EC** roof fans.



Design

- o Counterflange made of galvanized steel.

Mounting

- o The end face is connected to the fan or other parts with bolts and the mating part is connected to the air duct.

Overall dimensions [mm]

Type	Standard size of compatible fans	Ø D	Ø D1	Ø D2	Ø d	L	Weight [kg]
FDL 220-225	190, 220, 225	183	210	235	7	40	0.34
FDL 250-315	250, 280, 310	256	285	306	7	40	0.52
FDL 355-500	355, 400, 450, 500	402	430	464	9	40	1.05
FDL 560	560, 630	567	605	639	9	40	1.60
FDL 710	710	634	674	708	9	40	3.15

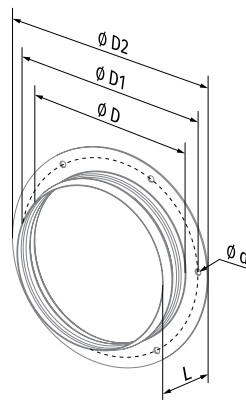

ALBE

Units for air cooling and heating

Use

- Air heating or cooling with water heater and its smooth distribution in a room with a fan and louvre shutters.
- Arranging of energy efficient air heating or cooling in various premises including medium and large-scale buildings.
- Local heating or cooling of job sites or separate areas.



Air flow:
up to 3850 m³/h
1070 l/s



Power:
from 136 W



Noise level:
from 53 dBA



Design

- The unit consists of a high-performance axial fan and a high-efficient copper-aluminium water heater.
- Steel polymer-coated casing equipped with louvre shutters for uniform air distribution.
- The water coils are equipped with internally threaded pipes on the casing side for connection to the heat medium.
- Fixing brackets are designed for wall or ceiling mounting.

Motor

- Asynchronous external rotor motor and axial impeller.
- Single-phase motor.
- Equipped with ball bearings for longer service life.
- Integrated thermal protection with automatic restart.

Speed control

- Smooth speed control with an external thyristor controller or step speed control with an external auto transformer (both available upon separate order).
- Fan speed control provides regulation of the air flow and respectively the thermal transmission for heating or cooling.
- The **SGWH** control unit is used for controlling the operation modes of the air heating (cooling) unit (available upon separate order).

Mounting

- The units may be installed vertically on walls or columns or horizontally on ceiling or beams.

Designation key

Series	Rated power [kW]
ALBE	- 25; 30; 45

Overall dimensions [mm]

Type	B	B1	H	H1	L	L2	K	Number of tube raw	Weight [kg]
ALBE-25	680	785	605	468	360	286	G 3/4"	2	37.0
ALBE-30	680	785	655	518	360	286	G 3/4"	2	40.0
ALBE-45	780	885	710	570	380	300	G 3/4"	2	50.0

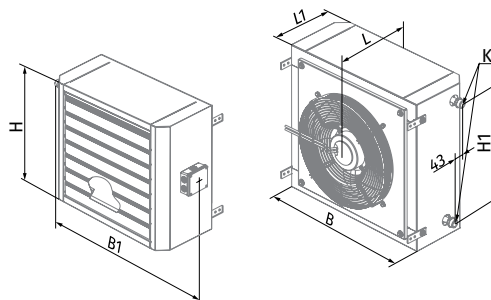

Accessories

Control units



SGWH

Mounting brackets



UM ALBE / UMU ALBE / UMP ALBE

Temperature controllers



MLC E2 / MLC D E2

Technical data

Parameters	ALBE-25	ALBE-30	ALBE-45
Voltage [V]	220-240	220-240	220-240
Frequency [Hz]	50	50	50
Fan power [W]	136	191	255
Fan current [A]	0.6	0.85	1.12
Maximum air flow [m ³ /h (l/s)]	2200 (611)	3000 (833)	3850 (1070)
RPM [min ⁻¹]	1350	1440	1360
Sound pressure at 3 m [dBA]	53	55	58
Maximum heat medium temperature [°C]	100	100	100
Insulation class	F	B	F
IP rating	IP44	IP44	IP44
Motor IP rating	IP44	IP44	IP44

Technical data for heating mode

Air flow [m ³ /h (l/s)]	Water inlet temperature [°C]	Supply air temperature [°C]	ALBE-25 Power [kW]	Outlet temperature [°C]	Water flow rate [l/s]	Water pressure loss [kPa]
2200 (611)	90/70	-15	34.5	26	0.42	7.5
		-10	32	29	0.39	6.6
		-5	30	32	0.36	5.8
		0	28	35	0.33	5.2
		5	26.2	38.5	0.33	4.5
		10	24.2	41.4	0.31	3.9
		15	22.1	44.2	0.28	3.3
	80/60	-15	30.4	21.2	0.36	6.0
		-10	28.3	24.3	0.34	5.3
		-5	26.2	27.4	0.33	4.6
		0	24.1	30.4	0.31	4.0
		5	22.1	33.3	0.28	3.3
		10	20.1	36.1	0.26	2.8
		15	18.1	38.8	0.25	2.3
	70/50	-15	26	16	0.33	4.6
		-10	24	19.2	0.31	4.0
		-5	22	22	0.28	3.4
		0	20	25	0.25	2.8
		5	18	28	0.22	2.3
		10	15.9	30.6	0.19	1.9
		15	13.8	33	0.17	1.4
	60/40	-15	22	11	0.28	3.4
		-10	20	14	0.25	2.8
		-5	18	17	0.22	2.3
0		16	20	0.19	1.8	
5		14	22	0.17	1.4	
10		12	25	0.14	1.0	
15		9.0	27	0.11	0.7	

Technical data for cooling mode

Air flow [m ³ /h (l/s)]	Water inlet temperature [°C]	Supply air temperature [°C]	ALBE-25 Power [kW]	Outlet temperature [°C]	Water flow rate [l/s]	Water pressure loss [kPa]
2200 (611)	7/12	35	9.1	26	0.44	7.5
		30	5.8	22.5	0.28	6.1
		25	3.2	21	0.17	2.1
		20	2.0	18	0.08	0.9

Technical data for heating mode

Air flow [m³/h (l/s)]	Water inlet temperature [°C]	Supply air temperature [°C]	ALBE-30 Power [kW]	Outlet temperature [°C]	Water flow rate [l/s]	Water pressure loss [kPa]
3000 (833)	90/70	-15	48.4	27.2	0.58	7.4
		-10	45.4	30.3	0.56	6.6
		-5	42.4	33.4	0.53	5.9
		0	39.5	36.4	0.47	5.2
		5	36.7	39.4	0.44	4.5
		10	33.8	42.1	0.42	3.9
		15	31	44.9	0.39	3.3
	80/60	-15	42	22	0.53	6.0
		-10	39	25.2	0.47	5.3
		-5	36.7	28.2	0.44	4.6
		0	33.8	31.1	0.42	3.9
		5	30.9	34.0	0.39	3.4
		10	28.1	36.7	0.33	2.8
		15	25.3	40	0.31	2.3
	70/50	-15	36.6	17	0.44	4.7
		-10	33.7	20	0.42	4.0
		-5	30	22.9	0.39	3.4
		0	28	25.7	0.33	2.9
		5	25	28.5	0.31	2.4
		10	22	31.1	0.28	1.9
		15	19.4	33.7	0.25	1.5
	60/40	-15	31	11.7	0.36	3.5
		-10	27.6	14.6	0.33	2.9
		-5	24	17.4	0.31	2.4
0		21	20	0.28	1.9	
5		19	22.7	0.22	1.5	
10		16	25.2	0.19	1.1	
15		13	27.5	0.17	0.7	

Technical data for cooling mode

Air flow [m³/h (l/s)]	Water inlet temperature [°C]	Supply air temperature [°C]	ALBE-30 Power [kW]	Outlet temperature [°C]	Water flow rate [l/s]	Water pressure loss [kPa]
3000 (833)	7/12	35	11.4	27	0.56	11.2
		30	7.3	22.9	0.36	5.0
		25	3.9	21.1	0.19	1.6
		20	2.4	17.7	0.11	0.7

Technical data for heating mode

Air flow [m³/h (l/s)]	Water inlet temperature [°C]	Supply air temperature [°C]	ALBE-45 Power [kW]	Outlet temperature [°C]	Water flow rate [l/s]	Water pressure loss [kPa]
3850 (1070)	90/70	-15	63.0	28.4	0.78	11.9
		-10	59.2	31.5	0.72	10.6
		-5	55.4	34.6	0.67	9.4
		0	51.6	37.5	0.64	8.3
		5	47.9	40.4	0.58	7.3
		10	44.3	43.2	0.56	6.3
		15	40.6	45.9	0.50	5.4
	80/60	-15	55.6	23.3	0.67	9.7
		-10	51.8	26.4	0.64	8.5
		-5	48.0	29.3	0.58	7.4
		0	44.3	32.2	0.56	6.4
		5	40.6	35.0	0.50	5.5
		10	37.0	37.8	0.44	4.6
		15	33.4	40.4	0.42	3.8
	70/50	-15	48.1	18.1	0.58	7.6
		-10	44.3	21.1	0.53	6.6
		-5	40.6	23.9	0.50	5.6
		0	36.9	26.8	0.44	4.7
		5	33.2	29.5	0.42	3.9
		10	29.6	32.2	0.36	3.2
		15	26.0	34.8	0.31	2.5
	60/40	-15	40.4	12.8	0.50	5.7
		-10	36.7	15.7	0.44	4.8
		-5	32.9	18.5	0.39	3.9
0		29.2	21.3	0.36	3.2	
5		25.6	23.9	0.31	2.5	
10		21.9	26.4	0.28	1.9	
15		18.1	28.8	0.22	1.3	

Technical data for cooling mode

Air flow [m³/h (l/s)]	Water inlet temperature [°C]	Supply air temperature [°C]	ALBE-45 Power [kW]	Outlet temperature [°C]	Water flow rate [l/s]	Water pressure loss [kPa]
3850 (1070)	7/12	35	18.0	24.9	0.86	31.8
		30	10.8	21.7	0.53	12.9
		25	7.3	19	0.36	6.3
		20	3.2	17.4	0.14	1.4

EKH

Duct electrical heaters

Use

- For warming up of supply air in heating, ventilation and air conditioning systems installed in various premises.
- Compatible with Ø 100 to 315 mm round air ducts.



Design

- Galvanized steel case and junction box.
- Heating elements made of stainless steel.
- Airtight connection with air ducts due to rubber seals.
- Several power options for each standard size.
- For higher heating capacity several heaters may be installed in series.
- Equipped with overheat protection thermostats:
 - basic protection with automatic restart at +50 °C;
 - emergency protection with manual restart at +90 °C.

Mounting

- Fixing to round ducts with clamps.
- Any mounting position except for the junction box downwards to prevent condensate leakage and short circuit.
- Install a filter upstream to the heater to protect heating elements against dirt ingress.

- Recommended distance between the heater and other system components must be not less than two connecting diameters for air flow stabilization.
- Duct heaters are rated for minimum air flow speed 1.5 m/s and maximum air temperature supplied to the units 40 °C. In case of speed regulation with a speed controller the minimum air speed through the heater must be provided.
- For correct and safe heater operation an automatic control and protection system is recommended including the following functions:
 - regulation of the heating capacity and temperature of the air heated up;
 - filter clogging control by a differential air pressure sensor;
 - power cut-off in case of supply fan shutdown or low air flow speed as well as in case of actuating the overheat protection thermostats;
 - heat removal from the heating elements after ventilation system shutdown.

Designation key

Series	Connected air duct diameter [mm]	Heater power [kW]
EKH	150; 160; 200; 250; 315	- 0.6; 0.8; 1.2; 1.6; 1.8; 2.4; 3; 3.4; 3.6; 5.1; 6; 9

Overall dimensions [mm]

Model	∅ D	B	H	L	L1	L2
EKH 100-0.6	99	94	207	306	226	40
EKH 100-0.8	99	94	207	306	226	40
EKH 100-1.2	99	94	207	306	226	40
EKH 100-1.6	99	94	207	306	226	40
EKH 100-1.8	99	94	207	376	296	40
EKH 125-0.6	124	103	230	306	226	40
EKH 125-0.8	124	103	230	306	226	40
EKH 125-1.2	124	103	230	306	226	40
EKH 125-1.6	124	103	230	306	226	40
EKH 125-2.4	124	103	230	376	296	40
EKH 150-1.2	149	120	255	306	226	40
EKH 150-2.4	149	120	255	306	226	40
EKH 150-3.4	149	120	255	306	226	40
EKH 150-3.6	149	120	255	376	296	40
EKH 150-5.1	149	120	255	376	296	40
EKH 150-6	149	120	255	376	296	40
EKH 160-1.2	159	120	267	306	226	40
EKH 160-2.4	159	120	267	306	226	40
EKH 160-3.4	159	120	267	306	226	40
EKH 160-3.6	159	120	267	376	296	40
EKH 160-5.1	159	120	267	376	296	40
EKH 160-6	159	120	267	376	296	40
EKH 200-1.2	199	150	302	294	214	40
EKH 200-2.4	199	150	302	294	214	40
EKH 200-3.4	199	150	302	294	214	40
EKH 200-3.6	199	150	302	376	296	40
EKH 200-5.1	199	150	302	376	296	40
EKH 200-6	199	150	302	376	296	40
EKH 250-1.2	249	150	356	306	226	40
EKH 250-2.4	249	150	356	306	226	40
EKH 250-3	249	150	356	306	226	40
EKH 250-3.6	249	150	356	376	296	40
EKH 250-6	249	150	356	376	296	40
EKH 250-9	249	150	356	376	296	40
EKH 315-1.2	313	150	425	294	214	40
EKH 315-2.4	313	150	425	294	214	40
EKH 315-3.6	313	150	425	376	296	40
EKH 315-6	313	150	425	376	296	40
EKH 315-9	313	150	425	376	296	40

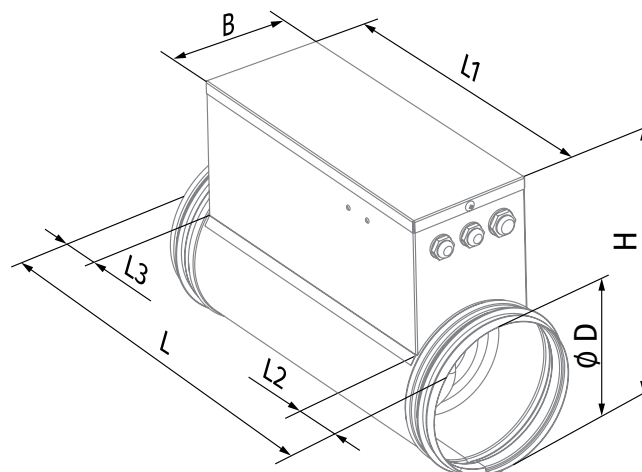

Technical data

Model	Minimum air flow [m³/h (l/s)]	Current [A]	Voltage [V]	Power [kW]	Number of heating coils x capacity [kW]	Phase	Weight [kg]
EKH 100-0.6	60 (17)	2.6	230	0.6	1x0.6	1	2.6
EKH 100-0.8	80 (22)	3.5	230	0.8	1x0.8	1	2.6
EKH 100-1.2	90 (25)	5.2	230	1.2	2x0.6	1	2.9
EKH 100-1.6	120 (33)	7.0	230	1.6	2x0.8	1	2.9
EKH 100-1.8	130 (36)	7.8	230	1.8	3x0.6	1	3.1
EKH 125-0.6	60 (17)	2.6	230	0.6	1x0.6	1	2.4
EKH 125-0.8	80 (22)	3.5	230	0.8	1x0.8	1	2.4
EKH 125-1.2	90 (25)	5.2	230	1.2	2x0.6	1	2.7
EKH 125-1.6	120 (33)	7.0	230	1.6	2x0.8	1	2.7
EKH 125-2.4	150 (42)	7.8	230	2.4	3x0.8	1	3.0
EKH 150-1.2	120 (33)	5.2	230	1.2	1x1.2	1	2.5
EKH 150-2.4	150 (42)	10.4	230	2.4	2x1.2	1	3.1
EKH 150-3.4	220 (61)	14.7	230	3.4	2x1.7	1	3.1
EKH 150-3.6	265 (74)	5.2	400	3.6	3x1.2	3	4.1
EKH 150-5.1	320 (89)	7.4	400	5.1	3x1.7	3	4.1
EKH 150-6	360 (100)	8.7	400	6.0	3x2.0	3	4.1
EKH 160-1.2	150 (42)	5.2	230	1.2	1x1.2	1	2.1
EKH 160-2.4	180 (50)	10.4	230	2.4	2x1.2	1	2.9
EKH 160-3.4	250 (69)	14.8	230	3.4	2x1.7	1	3.2
EKH 160-3.6	265 (74)	5.2	400	3.6	3x1.2	3	3.9
EKH 160-5.1	375 (104)	7.4	400	5.1	3x1.7	3	3.9
EKH 160-6	440 (122)	8.7	400	6.0	3x2.0	3	3.9
EKH 200-1.2	150 (42)	5.2	230	1.2	1x1.2	1	2.4
EKH 200-2.4	180 (50)	10.4	230	2.4	2x1.2	1	3.2
EKH 200-3.4	250 (69)	14.8	230	3.4	2x1.7	1	3.3
EKH 200-3.6	265 (74)	5.2	400	3.6	3x1.2	3	4.1
EKH 200-5.1	375 (104)	7.4	400	5.1	3x1.7	3	4.1
EKH 200-6	440 (122)	8.7	400	6.0	3x2.0	3	4.1
EKH 250-1.2	180 (50)	5.2	230	1.2	1x1.2	1	2.4
EKH 250-2.4	265 (74)	10.4	230	2.4	2x1.2	1	2.6
EKH 250-3	375 (104)	13.0	230	3.0	1x3.0	1	2.4
EKH 250-3.6	375 (104)	5.2	400	3.6	3x1.2	3	2.9
EKH 250-6	440 (122)	8.7	400	6.0	3x2.0	3	2.9
EKH 250-9	660 (183)	13.0	400	9.0	3x3.0	3	2.9
EKH 315-1.2	180 (50)	5.2	230	1.2	1x1.2	1	2.6
EKH 315-2.4	265 (74)	10.4	230	2.4	2x1.2	1	2.8
EKH 315-3.6	375 (104)	5.2	400	3.6	3x1.2	3	3.1
EKH 315-6	440 (122)	8.7	400	6.0	3x2.0	3	3.1
EKH 315-9	660 (183)	13.0	400	9.0	3x3.0	3	3.1

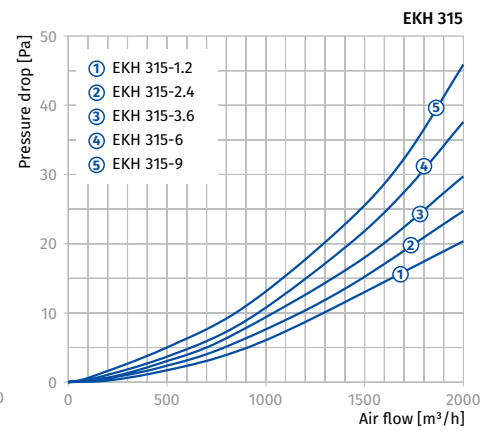
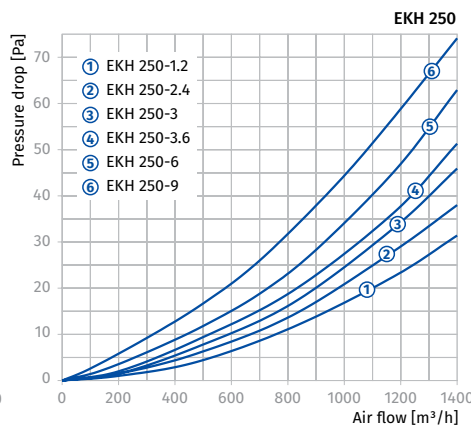
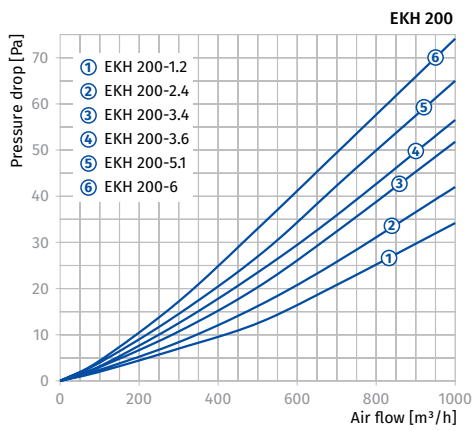
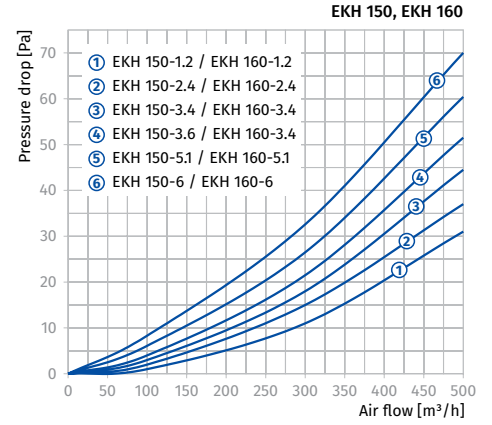
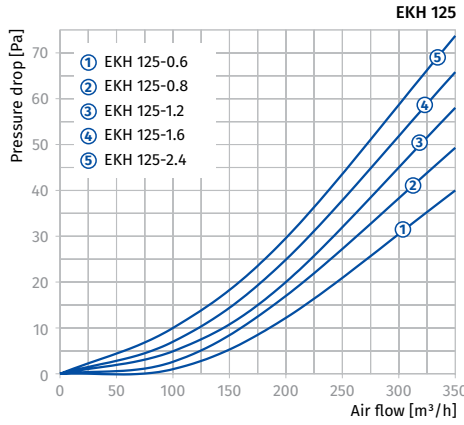
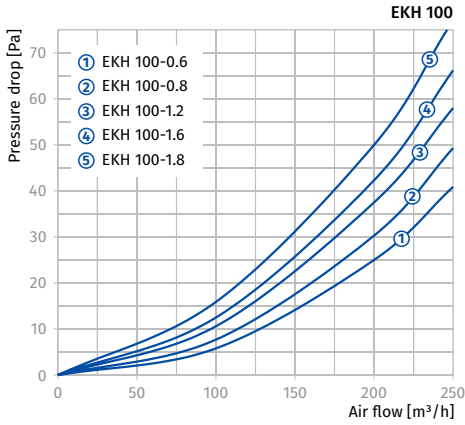

Air temperature increase as a function of air flow

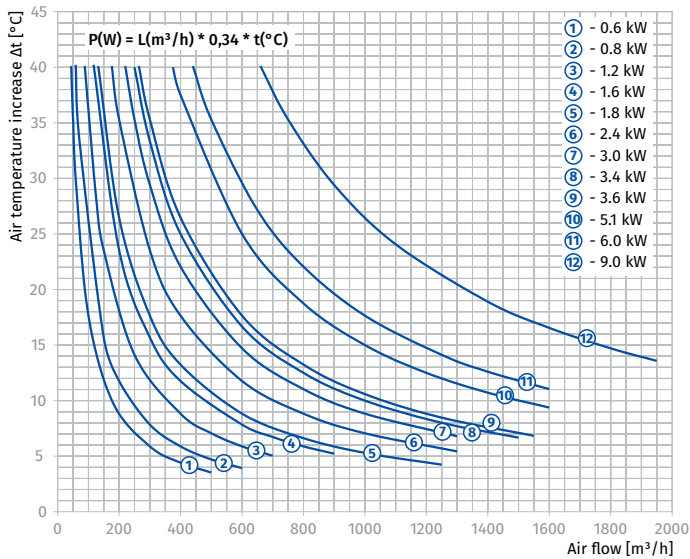

WKH

Duct water heaters for round ducts

Use

- For warming up of supply air in ventilation systems installed in various premises.
- Suitable for installation in supply or air handling units to warm up the supply air flow.
- For indoor use only if water serves as a heat carrier.
- For outdoor use antifreezing mixture (ethylene glycol solution).
- Compatible with Ø 100 to 315 mm round air ducts.



Design

- Galvanized steel case.
- Copper pipe manifold.
- Heat exchange surface made of aluminium plates.
- Airtight connection with air ducts due to rubber seals.
- Equipped with a nipple for the system deaeration.
- Outlet header is equipped with a spigot for installation of an immersion temperature sensor or freezing protection mechanism.
- Available in two- or four-row coil modifications.
- Suitable for operation at maximum operating pressure 1.6 MPa (16 bar) and maximum operating temperature +100 °C.

Mounting

- Fixing to round ducts with clamps.
- Any mounting position that ensures the heater deaeration.
- Install a filter upstream to the heater to protect heating elements against dirt ingress.
- Install the heater in front or behind the fan. In case of mounting behind the fan ensure a distance of not less than two connecting diameters for air flow stabilization and keep the maximum permissible air temperature inside the fan.
- Connect the heater on counter-flow basis, otherwise its capacity drops by 5–15 %. All the nomographic charts are rated for counter-flow connection.
- For correct and safe heater operation an automatic control and protection system is recommended, including the following functions:
 - regulation of the heating capacity and temperature of the air heated up;
 - filter clogging control by a differential air pressure sensor;
 - ventilation system start-up with pre-heated heater;
 - use of air dampers fitted with a spring return actuator;
 - fan turns off in case of freezing danger for the heater.

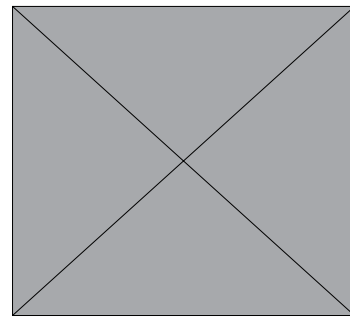

Connection against air flow

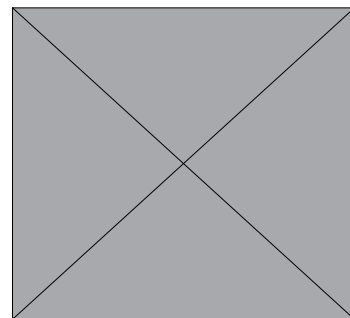

Connection along air flow

Designation key

Series	Connected air duct diameter [mm]	Number of water (glycol) coil rows
WKH	100; 125; 150; 160; 200; 250; 315	- 2; 4

Overall dimensions [mm]

Model	Ø D	B	H	H2	L	L1	L2	L3	K	Number of water coil rows	Weight [kg]
WKH 100-2	99	350	230	150	300	32	43	220	G 3/4"	2	3.9
WKH 100-4	99	350	230	150	300	28	65	220	G 3/4"	4	5.2
WKH 125-2	124	350	230	150	300	32	43	220	G 3/4"	2	4.0
WKH 125-4	124	350	230	150	300	28	65	220	G 3/4"	4	5.3
WKH 150-2	149	400	280	200	300	32	43	220	G 3/4"	2	7.5
WKH 150-4	149	400	280	200	300	28	65	220	G 3/4"	4	8.2
WKH 160-2	159	400	280	200	300	32	43	220	G 3/4"	2	7.5
WKH 160-4	159	400	280	200	300	28	65	220	G 3/4"	4	8.2
WKH 200-2	198	400	280	200	300	32	43	220	G 3/4"	2	7.5
WKH 200-4	198	400	280	200	300	28	65	220	G 3/4"	4	8.2
WKH 250-2	248	470	350	270	350	32	43	270	G 1"	2	10.3
WKH 250-4	248	470	350	270	350	28	65	270	G 1"	4	10.8
WKH 315-2	313	550	430	350	450	57	43	370	G 1"	2	12.6
WKH 315-4	313	550	430	350	450	53	65	370	G 1"	4	13.4

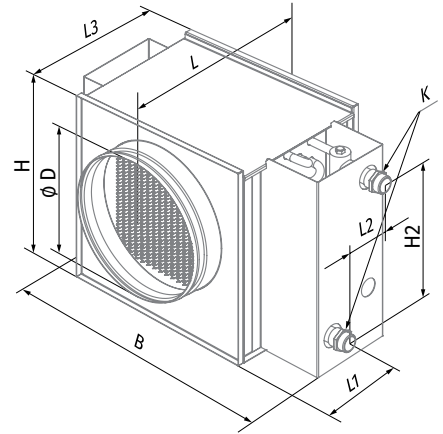

AIR PRESSURE LOSS FOR WATER HEATERS WKH

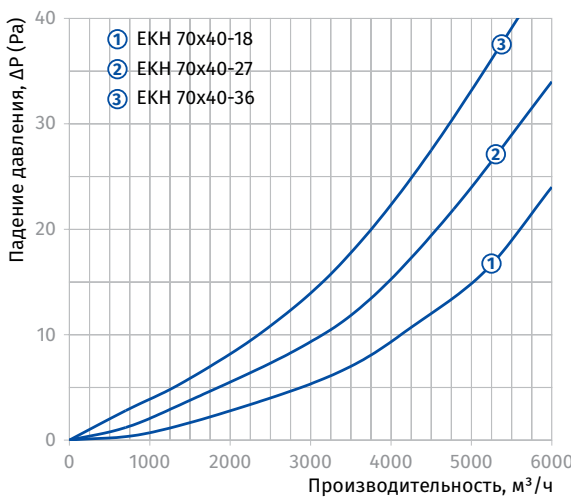

Water heaters calculation diagram

WKH 100-2 / WKH 125-2

Air temperature downstream of the water heating coils [°C]

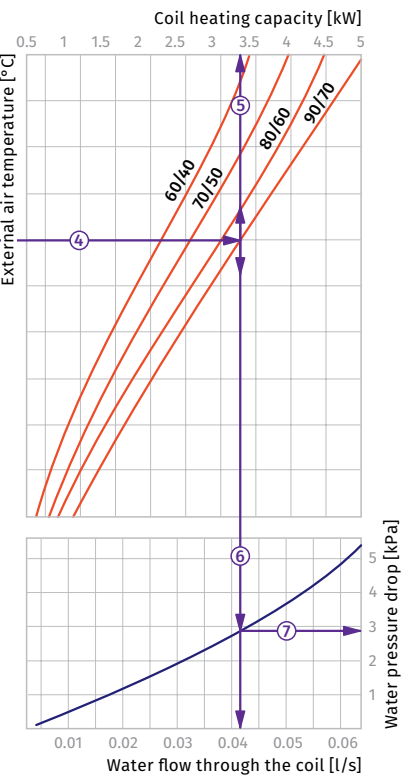
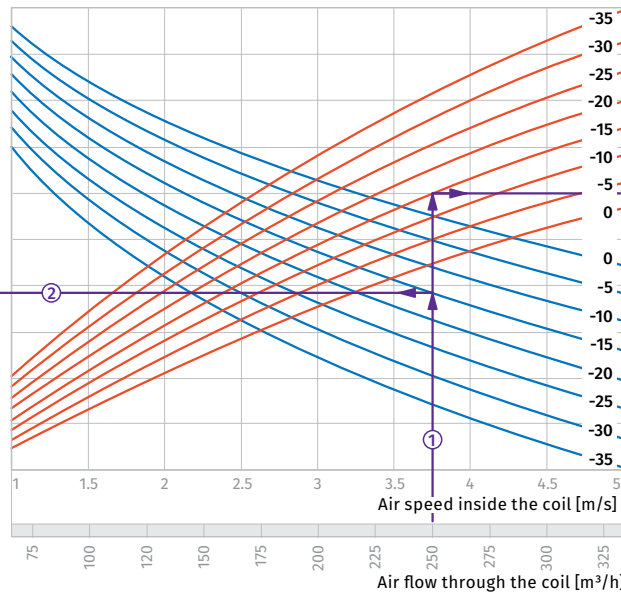
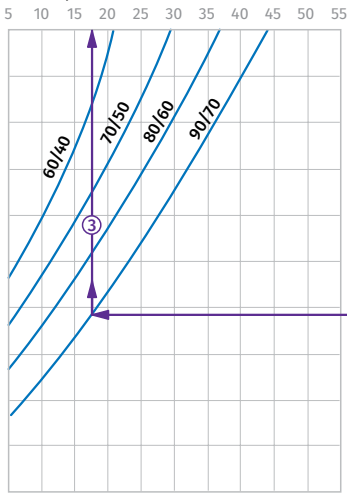

How to use water heater diagrams.

System Parameters: Air flow = 250 m³/h.
Outside air temperature = -15 °C.
Water temperature (in/out) = +90/+70 °C.
The air flow is 250 m³/h and the air speed in the heater is 3.75 m/s ①.

- To calculate the maximum air temperature find the intersection point of the air flow line ① with the rated outer temperature shown in blue line (e.g., -15 °C) and draw the line ② to the left until it crosses the water in/out temperature curve (e.g., +90/+70). From this point draw a vertical line to the supply air temperature downstream of the heater (+17.50 °C) ③.

- To calculate the heater power find the intersection point of the air flow ① with the rated winter temperature shown in red line (e.g., -15 °C) and draw the line ④ to the right until it crosses the water in/out temperature curve (e.g., +90/+70). From this point draw a vertical line to the heater power axis (3.25 kW) ⑤.

- To calculate the required water flow in the heater prolong this line ⑥ downwards to the water flow axis (0.042 l/s).
- To calculate the water pressure drop in the heater find the intersection point of the line ⑥ with the pressure loss curve and prolong the line ⑦ to the right on the water pressure drop axis (2.9 kPa).

WKH 100-4 / WKH 125-4

Air temperature downstream of the water heating coils [°C]

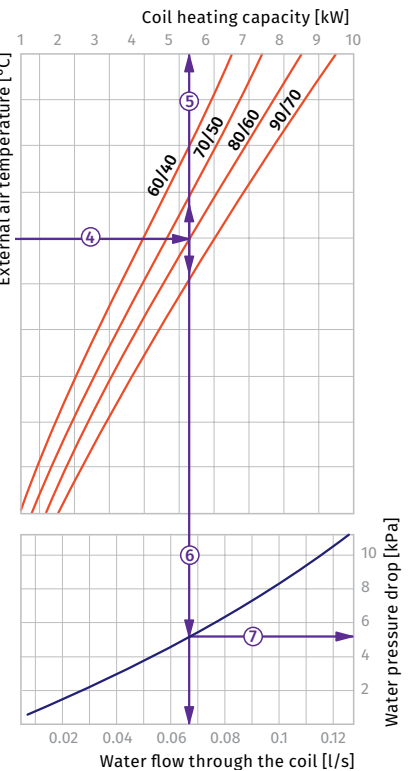
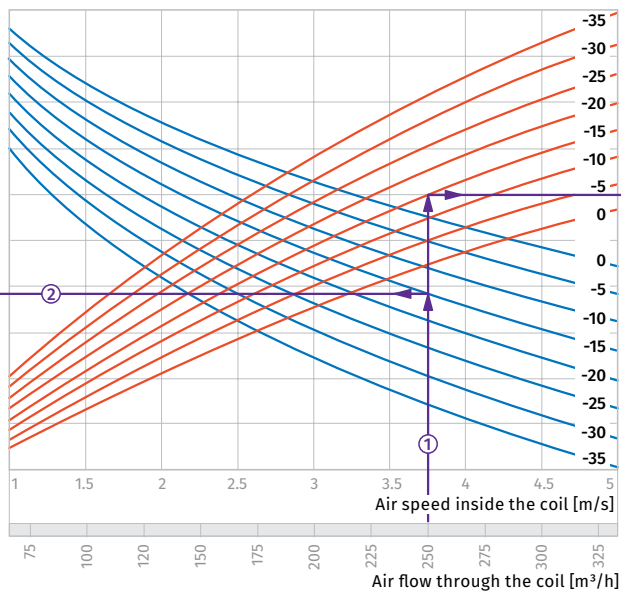
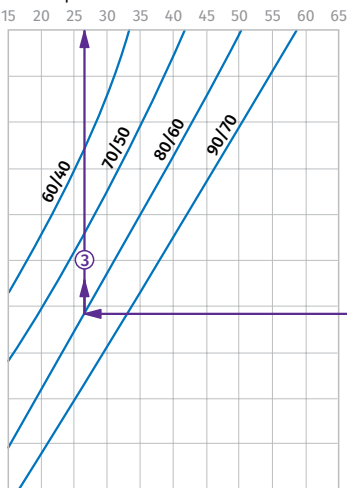

How to use water heater diagrams.

System Parameters: Air flow = 250 m³/h.
Outside air temperature = -15 °C.
Water temperature (in/out) = +80/+60 °C.
The air flow is 250 m³/h and the air speed in the heater is 3.75 m/s ①.

- To calculate the maximum air temperature find the intersection point of the air flow line ① with the rated outer temperature shown in blue line (e.g., -15 °C) and draw the line ② to the left until it crosses the water in/out temperature curve (e.g., +80/+60). From this point draw a vertical line to the supply air temperature downstream of the heater (+27 °C) ③.

- To calculate the heater power find the intersection point of the air flow ① with the rated winter temperature shown in red line (e.g., -15 °C) and draw the line ④ to the right until it crosses the water in/out temperature curve (e.g., +80/+60). From this point draw a vertical line to the heater power axis (5.2 kW) ⑤.

- To calculate the required water flow in the heater prolong this line ⑥ downwards to the water flow axis (0.067 l/s).
- To calculate the water pressure drop in the heater find the intersection point of the line ⑥ with the pressure loss curve and prolong the line ⑦ to the right on the water pressure drop axis (5.2 kPa).

WKH 150-2 / WKH 160-2 / WKH 200-2

Air temperature downstream of the water heating coils [°C]

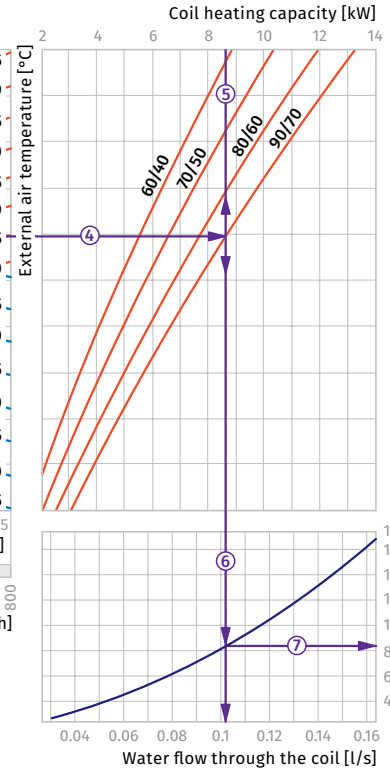
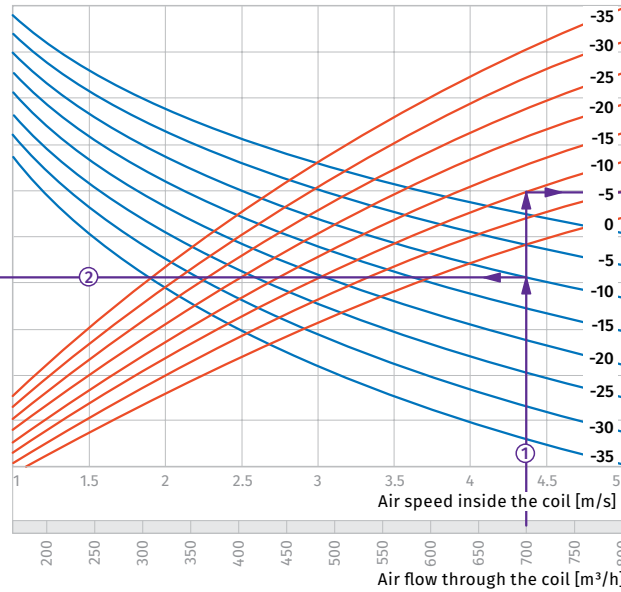
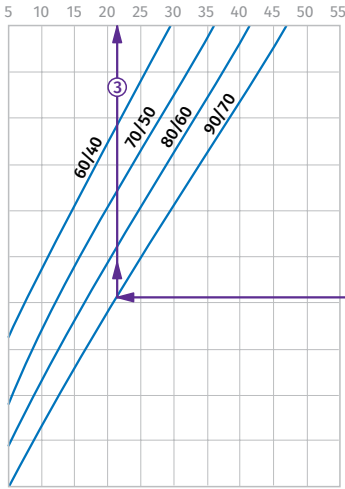

How to use water heater diagrams.

System Parameters: Air flow = 700 m³/h.
 Outside air temperature = -10 °C.
 Water temperature (in/out) = +90/+70 °C.
 The air flow is 700 m³/h and the air speed in the heater is 4.4 m/s ①.

- To calculate the maximum air temperature find the intersection point of the air flow line ① with the rated outer temperature shown in blue line (e.g., -10 °C) and draw the line ② to the left until it crosses the water in/out temperature curve (e.g., +90/+70). From this point draw a vertical line to the supply air temperature downstream of the heater (+21 °C) ③.

- To calculate the heater power find the intersection point of the air flow ① with the rated winter temperature shown in red line (e.g., -10 °C) and draw the line ④ to the right until it crosses the water in/out temperature curve (e.g., +90/+70). From this point draw a vertical line to the heater power axis (8.6 kW) ⑤.

- To calculate the required water flow in the heater prolong this line ⑥ downwards to the water flow axis (0.11 l/s).
- To calculate the water pressure drop in the heater find the intersection point of the line ⑥ with the pressure loss curve and prolong the line ⑦ to the right on the water pressure drop axis (8.2 kPa).

WKH 150-4 / WKH 160-4 / WKH 200-4

Air temperature downstream of the water heating coils [°C]

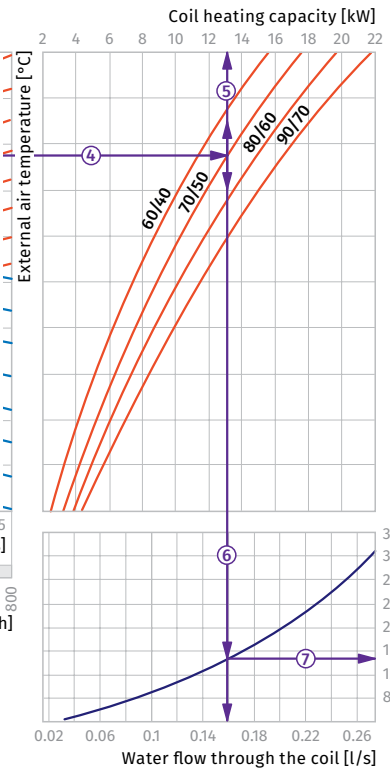
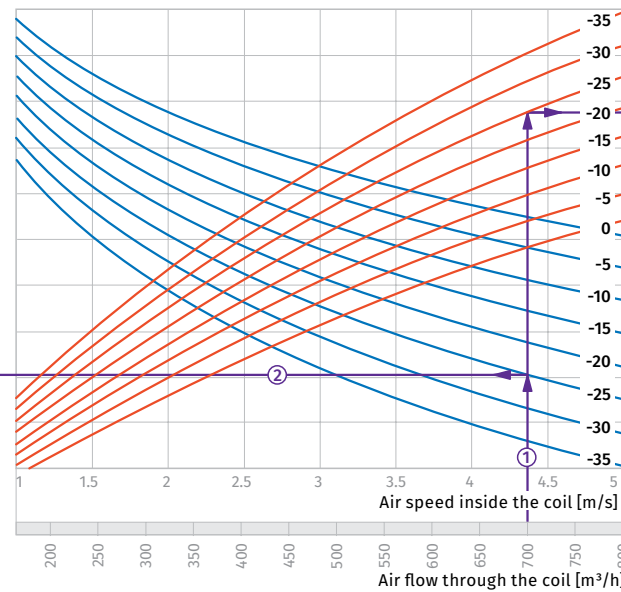
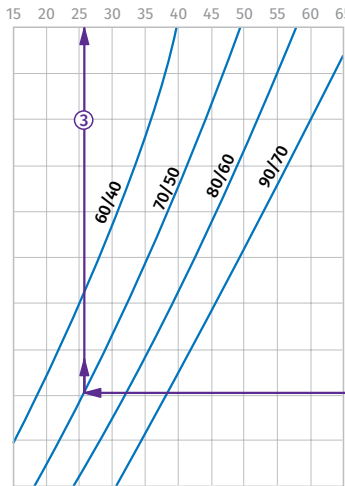

How to use water heater diagrams.

System Parameters: Air flow = 700 m³/h.
 Outside air temperature = -25 °C.
 Water temperature (in/out) = +70/+50 °C.
 The air flow is 700 m³/h and the air speed in the heater is 4.4 m/s ①.

- To calculate the maximum air temperature find the intersection point of the air flow line ① with the rated outer temperature shown in blue line (e.g., -25 °C) and draw the line ② to the left until it crosses the water in/out temperature curve (e.g., +70/+50). From this point draw a vertical line to the supply air temperature downstream of the heater (+26 °C) ③.

- To calculate the heater power find the intersection point of the air flow ① with the rated winter temperature shown in red line (e.g., -25 °C) and draw the line ④ to the right until it crosses the water in/out temperature curve (e.g., +70/+50). From this point draw a vertical line to the heater power axis (13.0 kW) ⑤.

- To calculate the required water flow in the heater prolong this line ⑥ downwards to the water flow axis (0.16 l/s).
- To calculate the water pressure drop in the heater find the intersection point of the line ⑥ with the pressure loss curve and prolong the line ⑦ to the right on the water pressure drop axis (15 kPa).

WKH 250-2

Air temperature downstream of the water heating coils [°C]

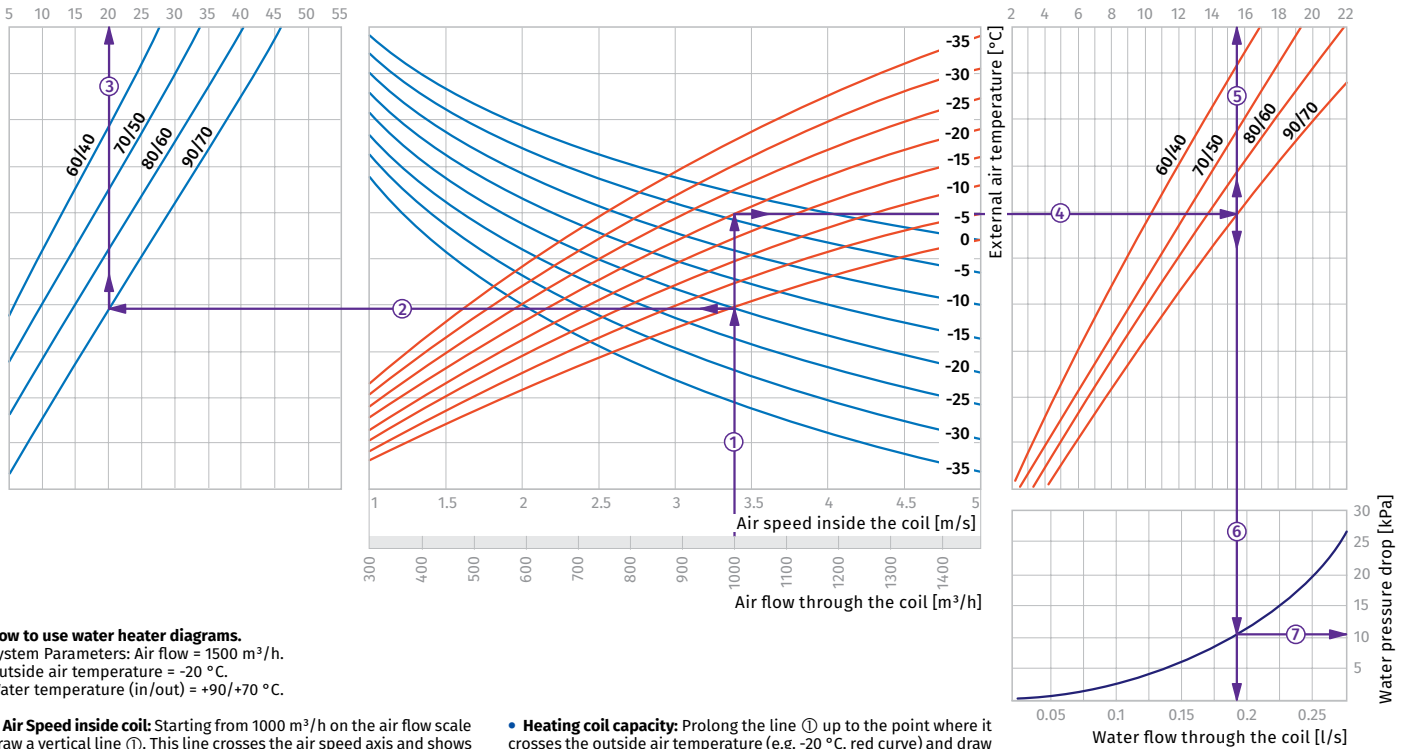

How to use water heater diagrams.
System Parameters: Air flow = 1500 m³/h.
Outside air temperature = -20 °C.
Water temperature (in/out) = +90/+70 °C.

- **Air Speed inside coil:** Starting from 1000 m³/h on the air flow scale draw a vertical line ①. This line crosses the air speed axis and shows a value of about 3.4 m/s.
- **Supply air temperature:** Prolong the line ① up to the point where it crosses the outside air temperature (blue curve, e.g. -20 °C); then draw a horizontal line ② from this point to the left until it crosses the water in/out temperature curve (e.g. +90/+70 °C). From this point draw a vertical line ③ to the supply air temperature axis on top of the graphic (+20 °C)

- **Heating coil capacity:** Prolong the line ① up to the point where it crosses the outside air temperature (e.g. -20 °C, red curve) and draw a horizontal line ④ from this point to the right until it crosses the water in/out temperature curve (e.g., +90/+70 °C). From here draw a vertical line ⑤ up to the scale representing the heating coil capacity (15.5 kW).
- **Water flow:** Prolong the line ⑤ down to the water flow axis ⑥ at the bottom of the graphic (0.19 l/s).
- **Water pressure drop:** Draw the line ⑦ from the point where the line ⑥ crosses the black curve to the pressure drop axis (11 kPa).

WKH 250-4

Air temperature downstream of the water heating coils [°C]

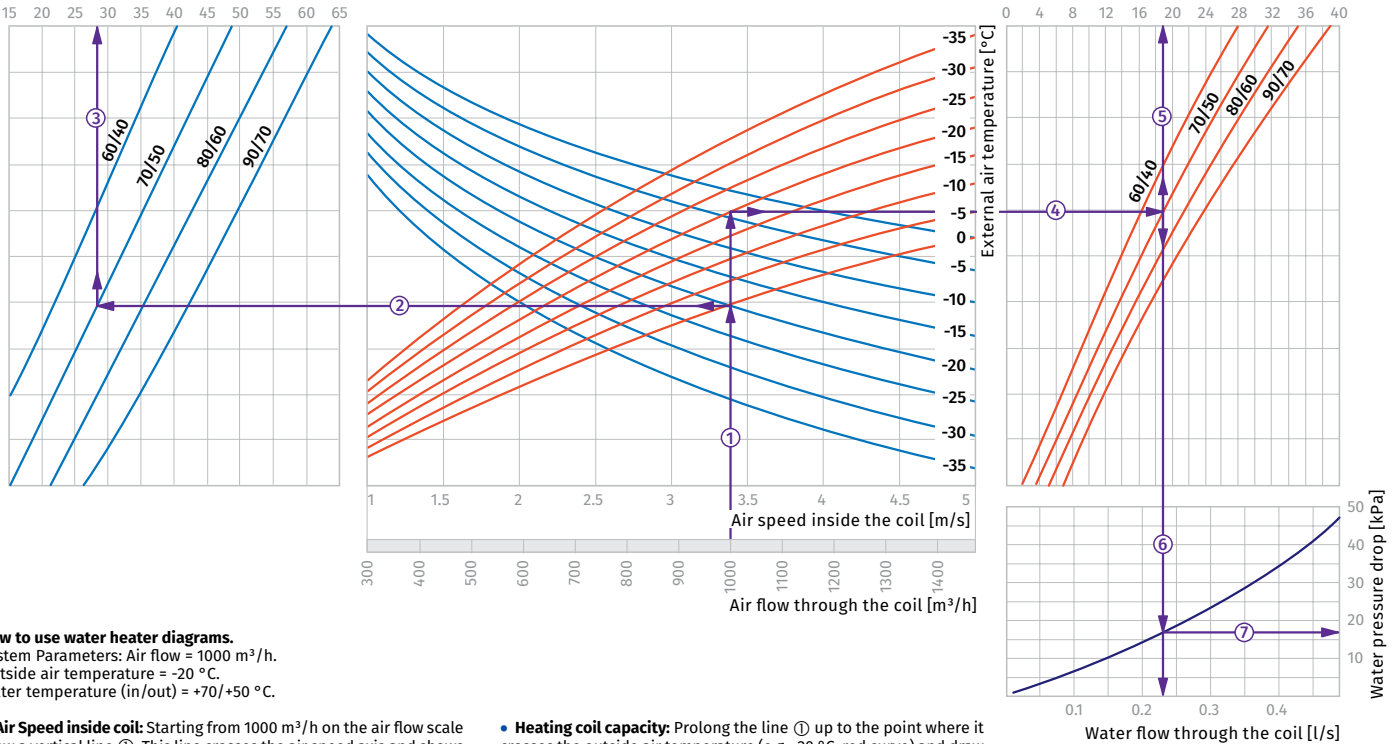

How to use water heater diagrams.
System Parameters: Air flow = 1000 m³/h.
Outside air temperature = -20 °C.
Water temperature (in/out) = +70/+50 °C.

- **Air Speed inside coil:** Starting from 1000 m³/h on the air flow scale draw a vertical line ①. This line crosses the air speed axis and shows a value of about 3.4 m/s.
- **Supply air temperature:** Prolong the line ① up to the point where it crosses the outside air temperature (blue curve, e.g. -20 °C); then draw a horizontal line ② from this point to the left until it crosses the water in/out temperature curve (e.g. +70/+50 °C). From this point draw a vertical line ③ to the supply air temperature axis on top of the graphic (+28 °C).

- **Heating coil capacity:** Prolong the line ① up to the point where it crosses the outside air temperature (e.g. -20 °C, red curve) and draw a horizontal line ④ from this point to the right until it crosses the water in/out temperature curve (e.g., +70/+50 °C). From here draw a vertical line ⑤ up to the scale representing the heating coil capacity (19 kW).
- **Water flow:** Prolong the line ⑤ down to the water flow axis ⑥ at the bottom of the graphic (0.23 l/s).
- **Water pressure drop:** Draw the line ⑦ from the point where the line ⑥ crosses the black curve to the pressure drop axis (17 kPa).

WKH 315-2

Air temperature downstream of the water heating coils [°C]

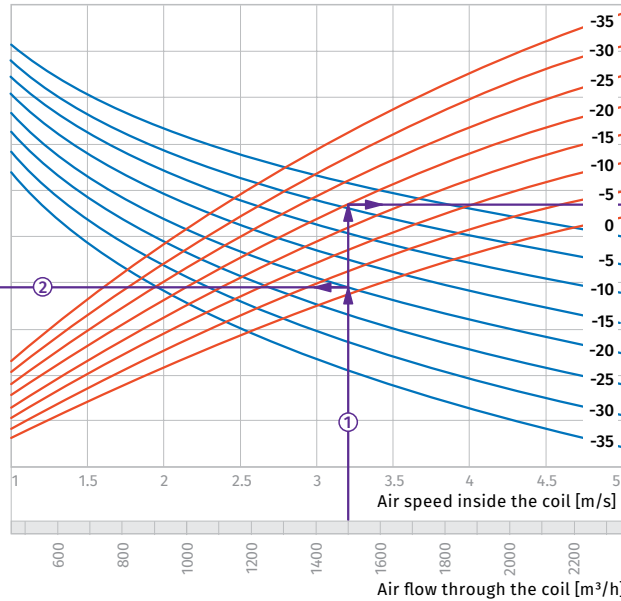
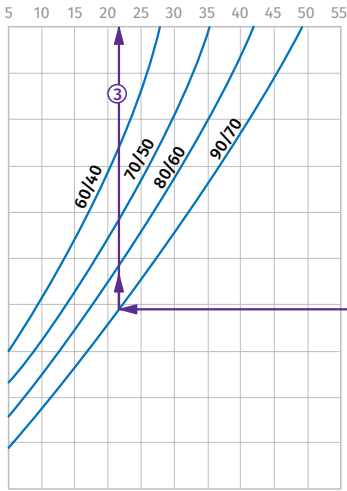

Coil heating capacity [kW]

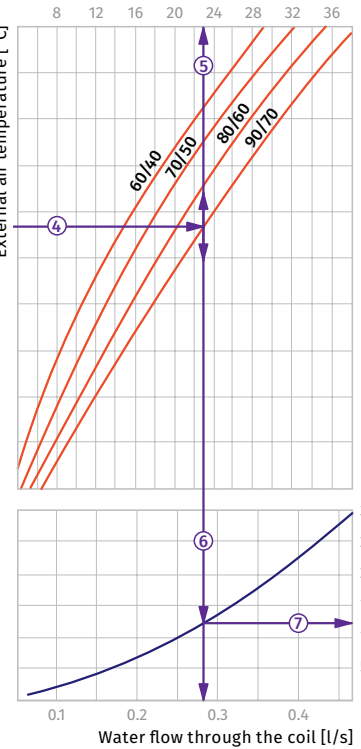

How to use water heater diagrams.
 System Parameters: Air flow = 1500 m³/h.
 Outside air temperature = -20 °C.
 Water temperature (in/out) = +90/+70 °C.

- **Air Speed inside coil:** Starting from 1500 m³/h on the air flow scale draw a vertical line ①. This line crosses the air speed axis and shows a value of about 3.2 m/s
- **Supply air temperature:** Prolong the line ① up to the point where it crosses the outside air temperature (blue curve, e.g. -20 °C); then draw a horizontal line ② from this point to the left until it crosses the water in/out temperature curve (e.g. +90/+70 °C). From this point draw a vertical line ③ to the supply air temperature axis on top of the graphic (+21 °C).

- **Heating coil capacity:** Prolong the line ① up to the point where it crosses the outside air temperature (e.g. -20 °C, red curve) and draw a horizontal line ④ from this point to the right until it crosses the water in/out temperature curve (e.g., +90/+70 °C). From here draw a vertical line ⑤ up to the scale representing the heating coil capacity (23 kW).
- **Water flow:** Prolong the line ⑤ down to the water flow axis ⑥ at the bottom of the graphic (0.28 l/s).
- **Water pressure drop:** Draw the line ⑦ from the point where the line ⑥ crosses the black curve to the pressure drop axis (12.5 kPa).

WKH 315-4

Air temperature downstream of the water heating coils [°C]

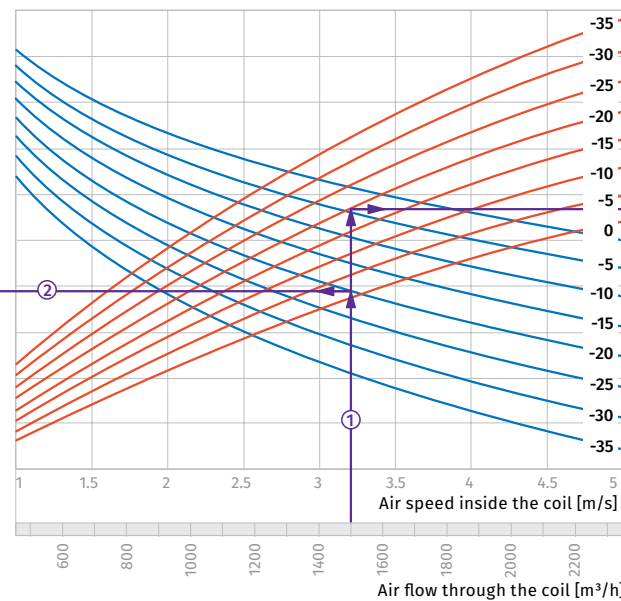
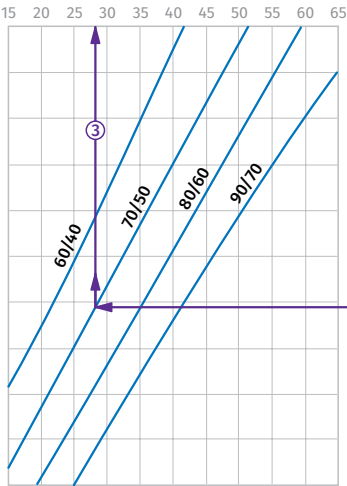

Coil heating capacity [kW]

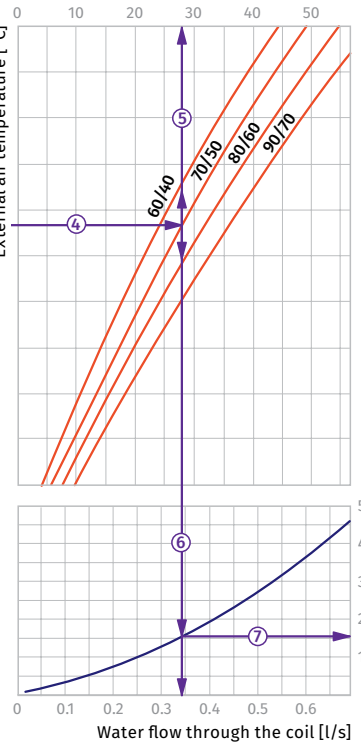

How to use water heater diagrams.
 System Parameters: Air flow = 1500 m³/h.
 Outside air temperature = -20 °C.
 Water temperature (in/out) = +70/+50 °C.

- **Air Speed inside coil:** Starting from 1500 m³/h on the air flow scale draw a vertical line ①. This line crosses the air speed axis and shows a value of about 3.2 m/s
- **Supply air temperature:** Prolong the line ① up to the point where it crosses the outside air temperature (blue curve, e.g. -20 °C); then draw a horizontal line ② from this point to the left until it crosses the water in/out temperature curve (e.g. +70/+50 °C). From this point draw a vertical line ③ to the supply air temperature axis on top of the graphic (+28 °C).

- **Heating coil capacity:** Prolong the line ① up to the point where it crosses the outside air temperature (e.g. -20 °C, red curve) and draw a horizontal line ④ from this point to the right until it crosses the water in/out temperature curve (e.g., +70/+50 °C). From here draw a vertical line ⑤ up to the scale representing the heating coil capacity (28.0 kW).
- **Water flow:** Prolong the line ⑤ down to the water flow axis ⑥ at the bottom of the graphic (0.34 l/s).
- **Water pressure drop:** Draw the line ⑦ from the point where the line ⑥ crosses the black curve to the pressure drop axis (16 kPa).

EKH

Duct electrical heaters for rectangular ducts

Use

- For warming up of supply air in heating, ventilation and air conditioning systems installed in various premises.
- Compatible with 400x200 up to 1000x500 mm rectangular air ducts.

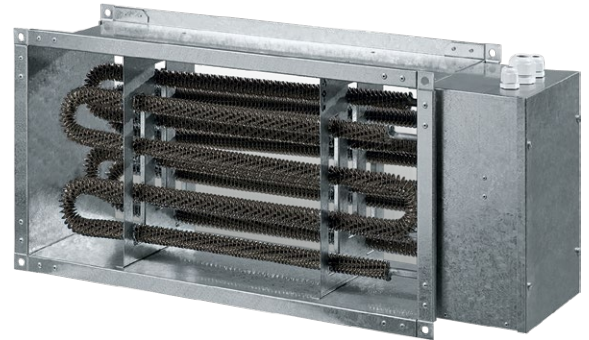

Design

- Galvanized steel case and junction box.
- Heating elements are made of stainless steel and have additional ribbing to increase heat exchange surface.
- Several power options for each standard size.
- For higher heating capacity several heaters may be installed in series.
- Equipped with overheat protection thermostats:
 - basic protection with automatic restart at +50 °C;
 - emergency protection with manual restart at +90 °C.

Mounting

- Fixing to rectangular ducts with flange connection.
- Any mounting position except for the junction box downwards to prevent condensate leakage and short circuit.
- Install a filter upstream to the heater to protect heating elements against dirt ingress.
- Recommended distance between the heater and other system components must be not less than one air heater diagonal for air flow stabilization.

- Duct heaters are rated for minimum air flow speed 1.5 m/s and maximum operating air temperature supplied to the units 40 °C. In case of speed regulation with a speed controller the minimum air speed through the heater must be provided.
- For correct and safe heater operation an automatic control and protection system is recommended, including the following functions:
 - regulation of the heating capacity and temperature of the air heated up;
 - filter clogging control by a differential air pressure sensor;
 - power cut-off in case of the supply fan shutdown or low air flow speed as well as in case of actuating the overheat protection thermostats;
 - heat removal from the heating elements after ventilation system shutdown.

Designation key

Series	Flange size (WxH) [cm]	Heater power [kW]
EKH	40x20; 50x25; 50x30; 60x30; 60x35; 70x40; 80x50; 90x50; 100x50	- 4.5; 6; 7.5; 9; 10.5; 12; 15; 18; 21; 24; 27; 36; 45; 54

Overall dimensions [mm]

Model	B	B1	B2	B3	H	H1	H2	L
EKH 40x20-4.5	400	420	440	540	200	220	240	200
EKH 40x20-6	400	420	440	540	200	220	240	200
EKH 40x20-7.5	400	420	440	540	200	220	240	200
EKH 40x20-9	400	420	440	540	200	220	240	200
EKH 40x20-10.5	400	420	440	540	200	220	240	200
EKH 40x20-12	400	420	440	540	200	220	240	200
EKH 40x20-15	400	420	440	540	200	220	240	200
EKH 50x25-6	500	520	540	640	250	270	290	200
EKH 50x25-7.5	500	520	540	640	250	270	290	200
EKH 50x25-9	500	520	540	640	250	270	290	200
EKH 50x25-10.5	500	520	540	640	250	270	290	200
EKH 50x25-12	500	520	540	640	250	270	290	200
EKH 50x25-15	500	520	540	640	250	270	290	200
EKH 50x25-18	500	520	540	640	250	270	290	200
EKH 50x25-21	500	520	540	640	250	270	290	200
EKH 50x30-6	500	520	540	640	300	320	340	200
EKH 50x30-7.5	500	520	540	640	300	320	340	200
EKH 50x30-9	500	520	540	640	300	320	340	200
EKH 50x30-10.5	500	520	540	640	300	320	340	200
EKH 50x30-12	500	520	540	640	300	320	340	200
EKH 50x30-15	500	520	540	640	300	320	340	200
EKH 50x30-18	500	520	540	640	300	320	340	200
EKH 50x30-21	500	520	540	640	300	320	340	200
EKH 60x30-9	600	620	640	740	300	320	340	200
EKH 60x30-12	600	620	640	740	300	320	340	200
EKH 60x30-15	600	620	640	740	300	320	340	200
EKH 60x30-18	600	620	640	740	300	320	340	200
EKH 60x30-21	600	620	640	740	300	320	340	200
EKH 60x30-24	600	620	640	740	300	320	340	200
EKH 60x35-9	600	620	640	740	350	370	390	200
EKH 60x35-12	600	620	640	740	350	370	390	200
EKH 60x35-15	600	620	640	740	350	370	390	200
EKH 60x35-18	600	620	640	740	350	370	390	200
EKH 60x35-21	600	620	640	740	350	370	390	200
EKH 60x35-24	600	620	640	740	350	370	390	200
EKH 70x40-18	700	720	740	840	400	420	440	390
EKH 70x40-27	700	720	740	840	400	420	440	510
EKH 70x40-36	700	720	740	840	400	420	440	750
EKH 80x50-27	800	820	840	940	500	520	540	390
EKH 80x50-36	800	820	840	940	500	520	540	510
EKH 80x50-54	800	820	840	940	500	520	540	750
EKH 90x50-45	900	920	940	1040	500	520	540	750
EKH 90x50-54	900	920	940	1040	500	520	540	750
EKH 100x50-45	1000	1020	1040	1140	500	520	540	750
EKH 100x50-54	1000	1020	1040	1140	500	520	540	750

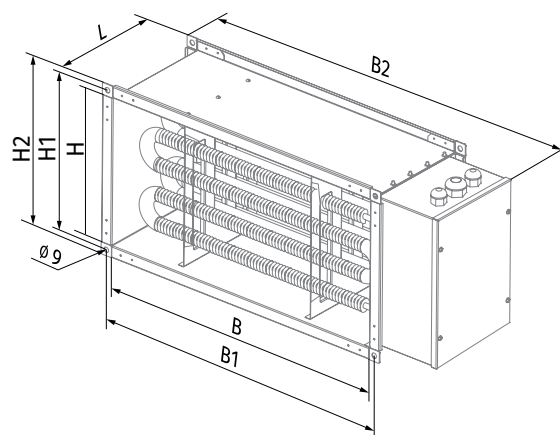

Technical data

Model	Minimum air flow [m ³ /h (l/s)]	Current [A]	Voltage [V]	Power [kW]	Number of heating coils x capacity [kW]	Weight [kg]
EKH 40x20-4.5	330 (92)	6.5	400	4.5	3x1.5	6.5
EKH 40x20-6	440 (122)	8.7	400	6.0	3x2.0	6.5
EKH 40x20-7.5	550 (153)	10.9	400	7.5	3x2.5	6.5
EKH 40x20-9	660 (183)	13.0	400	9.0	3x3.0	6.5
EKH 40x20-10.5	770 (214)	15.2	400	10.5	3x3.5	6.5
EKH 40x20-12	880 (244)	17.4	400	12.0	3x4.0	6.5
EKH 40x20-15	1100 (306)	21.7	400	15.0	3x5.0	6.5
EKH 50x25-6	440 (122)	8.7	400	6.0	3x2.0	7.65
EKH 50x25-7.5	550 (153)	10.9	400	7.5	3x2.5	7.65
EKH 50x25-9	660 (183)	13.0	400	9.0	3x3.0	7.65
EKH 50x25-10.5	770 (214)	15.2	400	10.5	3x3.5	7.65
EKH 50x25-12	880 (244)	17.4	400	12.0	3x4.0	7.65
EKH 50x25-15	1100 (306)	21.7	400	15.0	3x5.0	7.65
EKH 50x25-18	1320 (367)	26.0	400	18.0	3x6.0	7.65
EKH 50x25-21	1540 (428)	30.0	400	21.0	3x7.0	7.65
EKH 50x30-6	440 (122)	8.7	400	6.0	3x2.0	8.2
EKH 50x30-7.5	550 (153)	10.9	400	7.5	3x2.5	8.2
EKH 50x30-9	660 (183)	13.0	400	9.0	3x3.0	8.2
EKH 50x30-10.5	770 (214)	15.2	400	10.5	3x3.5	8.2
EKH 50x30-12	880 (244)	17.4	400	12.0	3x4.0	8.2
EKH 50x30-15	1100 (306)	21.7	400	15.0	3x5.0	8.2
EKH 50x30-18	1320 (367)	26.0	400	18.0	3x6.0	8.2
EKH 50x30-21	1540 (428)	30.0	400	21.0	3x7.0	8.2
EKH 60x30-9	660 (183)	13.0	400	9.0	3x3.0	9.4
EKH 60x30-12	880 (244)	17.4	400	12.0	3x4.0	9.4
EKH 60x30-15	1100 (306)	21.7	400	15.0	3x5.0	9.4
EKH 60x30-18	1320 (367)	26.0	400	18.0	3x6.0	9.4
EKH 60x30-21	1540 (428)	30.0	400	21.0	3x7.0	9.4
EKH 60x30-24	1760 (489)	34.7	400	24.0	3x8.0	9.4
EKH 60x35-9	660 (183)	13.0	400	9.0	3x3.0	9.75
EKH 60x35-12	880 (244)	17.4	400	12.0	3x4.0	9.75
EKH 60x35-15	1100 (306)	21.7	400	15.0	3x5.0	9.75
EKH 60x35-18	1320 (367)	26.0	400	18.0	3x6.0	9.75
EKH 60x35-21	1540 (428)	30.0	400	21.0	3x7.0	9.75
EKH 60x35-24	1760 (489)	34.7	400	24.0	3x8.0	9.75
EKH 70x40-18	1320 (367)	26.0	400	18.0	6x3.0	14.0
EKH 70x40-27	1980 (550)	39.0	400	27.0	9x3.0	18.5
EKH 70x40-36	2640 (733)	52.0	400	36.0	12x3.0	25.0
EKH 80x50-27	1980 (550)	39.0	400	27.0	9x3.0	19.0
EKH 80x50-36	2640 (733)	52.0	400	36.0	12x3.0	23.5
EKH 80x50-54	3960 (1100)	78.0	400	54.0	18x3.0	30.0
EKH 90x50-45	3300 (917)	65.0	400	45.0	15x3.0	31.0
EKH 90x50-54	3960 (1100)	78.0	400	54.0	18x3.0	33.5
EKH 100x50-45	3300 (917)	65.0	400	45.0	15x3.0	33.0
EKH 100x50-54	3960 (1100)	78.0	400	54.0	18x3.0	36.0

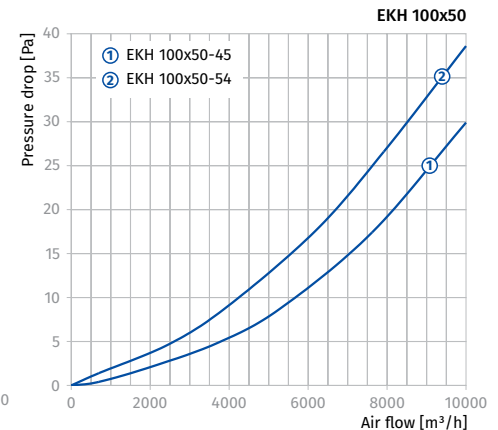
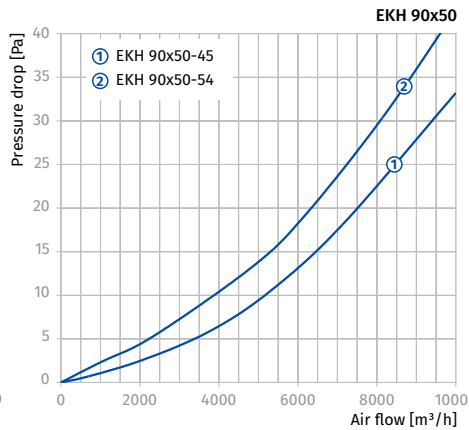
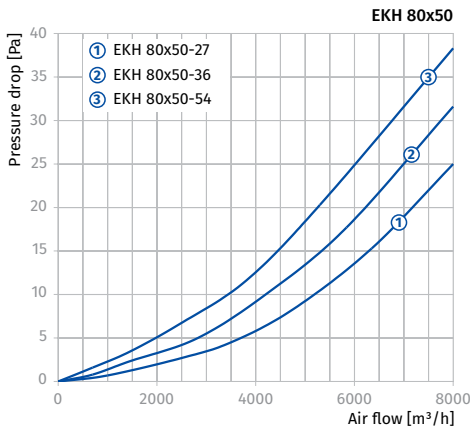
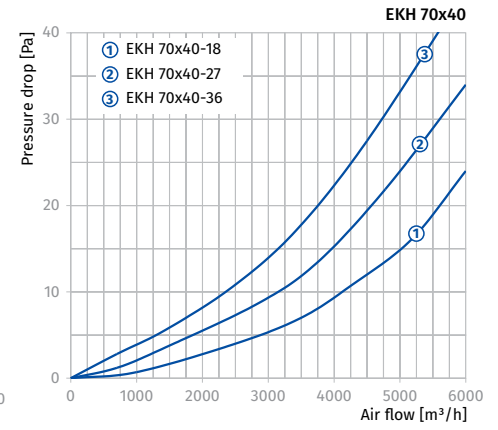
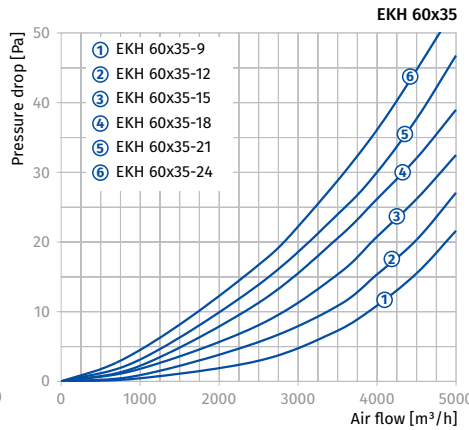
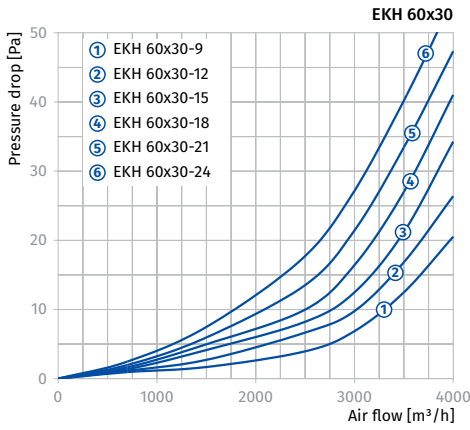
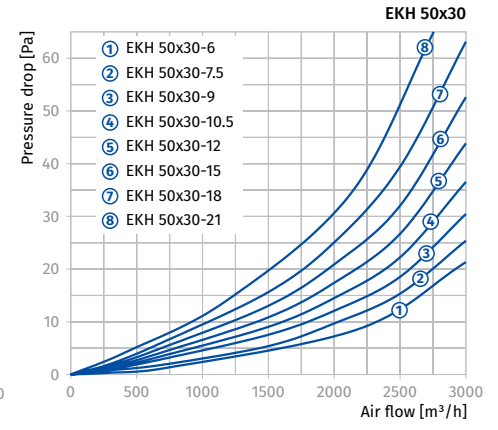
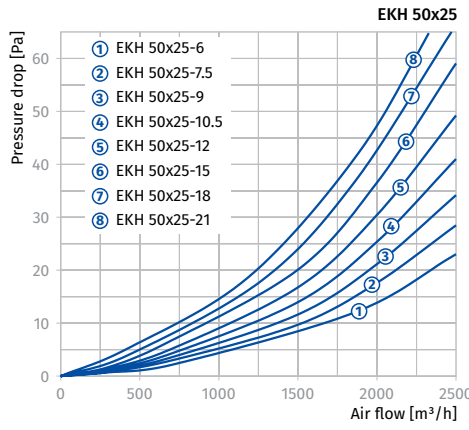
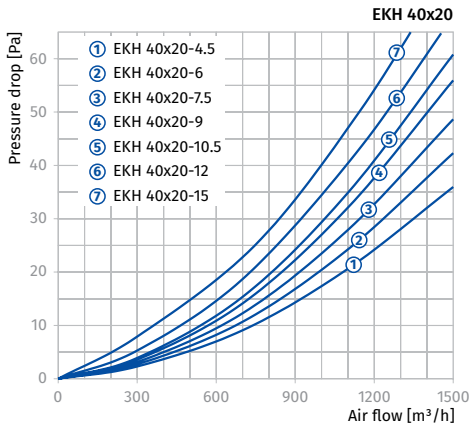

Air temperature increase as a function of air flow

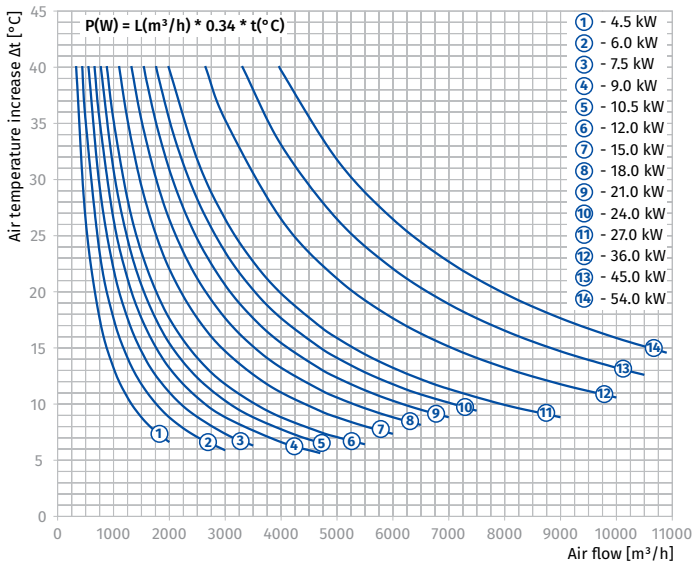

WKH

Duct water heaters for rectangular ducts

Use

- For warming up of supply air in ventilation systems installed in various premises.
- Suitable for installation in supply or air handling units to warm up the supply air flow.
- For indoor use only if water serves as a heat carrier.
- For outdoor use antifreezing mixture (ethylene glycol solution).
- Compatible with 400x200 up to 1000x500 mm rectangular air ducts.

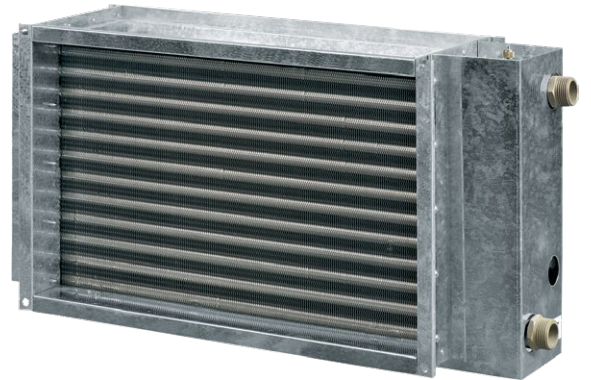

Design

- Galvanized steel case.
- Copper pipe manifold.
- Heat exchange surface made of aluminium plates.
- Equipped with a nipple for the system deaeration.
- Outlet header is equipped with a spigot for installation of an immersion temperature sensor or freezing protection mechanism.
- Available in two, three- or four-row tube modifications.
- Suitable for operation at maximum operating pressure 1.6 MPa (16 bar) and maximum transported air temperature +100 °C.

Mounting

- Fixing to rectangular ducts with flange connection.
- Any mounting position that ensures the heater deaeration.
- Install a filter upstream to the heater to protect heating elements against dirt ingress.
- Install the heater in front or behind the fan. In case of mounting behind the fan ensure the distance no less than 1-1.5 m for air flow stabilization and keep the maximum permissible air temperature inside the fan.
- Connect the heater on counter-flow basis, otherwise its capacity drops by 5-15 %. All the nomographic charts are rated for counter-flow connection.
- For correct and safe heater operation an automatic control and protection system is recommended, including the following functions:
 - regulation of the heating capacity and temperature of the air heated up;
 - filter clogging control by a differential air pressure sensor;
 - ventilation system start-up with pre-heated heater;
 - use of air dampers with a servo actuator with a return spring;
 - fan turning off in case of the heater freezing danger.

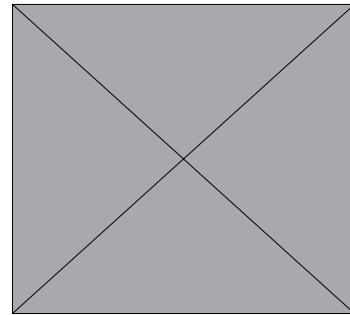

Connection against air flow

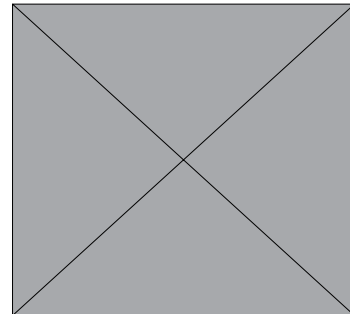

Connection along air flow

Designation key

Series	Flange size (WxH) [cm]	Number of water (glycol) coil rows
WKH	40x20; 50x25; 50x30; 60x30; 60x35; 70x40; 80x50; 90x50; 100x50	- 2; 3; 4

Overall dimensions [mm]

Model	B	B1	B2	B3	H	H1	H2	H3	L	L1	L2	K	Number of water coil rows	Weight [kg]
WKH 40x20-2	400	420	440	565	200	220	240	150	200	43	43	G 3/4"	2	7.6
WKH 40x20-4	400	420	440	565	200	220	240	150	200	38	65	G 3/4"	4	8.1
WKH 50x25-2	500	520	540	665	250	270	290	200	200	43	43	G 3/4"	2	15.8
WKH 50x25-4	500	520	540	665	250	270	290	200	200	38	65	G 3/4"	4	16.3
WKH 50x30-2	500	520	540	665	300	320	340	250	200	43	43	G 1"	2	11.5
WKH 50x30-4	500	520	540	665	300	320	340	250	200	38	65	G 1"	4	12.0
WKH 60x30-2	600	620	640	765	300	320	340	250	200	43	43	G 1"	2	21.8
WKH 60x30-4	600	620	640	765	300	320	340	250	200	38	65	G 1"	4	22.3
WKH 60x35-2	600	620	640	765	350	370	390	300	200	43	43	G 1"	2	22.4
WKH 60x35-4	600	620	640	765	350	370	390	300	200	38	65	G 1"	4	22.9
WKH 70x40-2	700	720	740	865	400	420	440	350	200	36	47	G 1"	2	27.8
WKH 70x40-3	700	720	740	865	400	420	440	350	200	42	58	G 1"	3	28.4
WKH 80x50-2	800	820	840	965	500	520	540	450	200	36	47	G 1"	2	36.5
WKH 80x50-3	800	820	840	965	500	520	540	450	200	42	58	G 1"	3	37.2
WKH 90x50-2	900	920	940	1065	500	520	540	450	200	36	47	G 1"	2	40.4
WKH 90x50-3	900	920	940	1065	500	520	540	450	200	42	58	G 1"	3	41.2
WKH 100x50-2	1000	1020	1040	1165	500	520	540	450	200	36	47	G 1"	2	44.3
WKH 100x50-3	1000	1020	1040	1165	500	520	540	450	200	42	58	G 1"	3	45.2

AIR PRESSURE LOSS FOR WATER HEATERS WKH

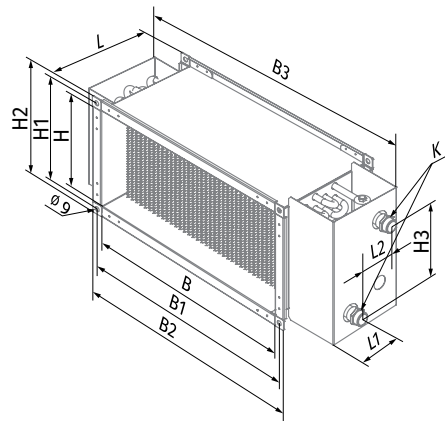
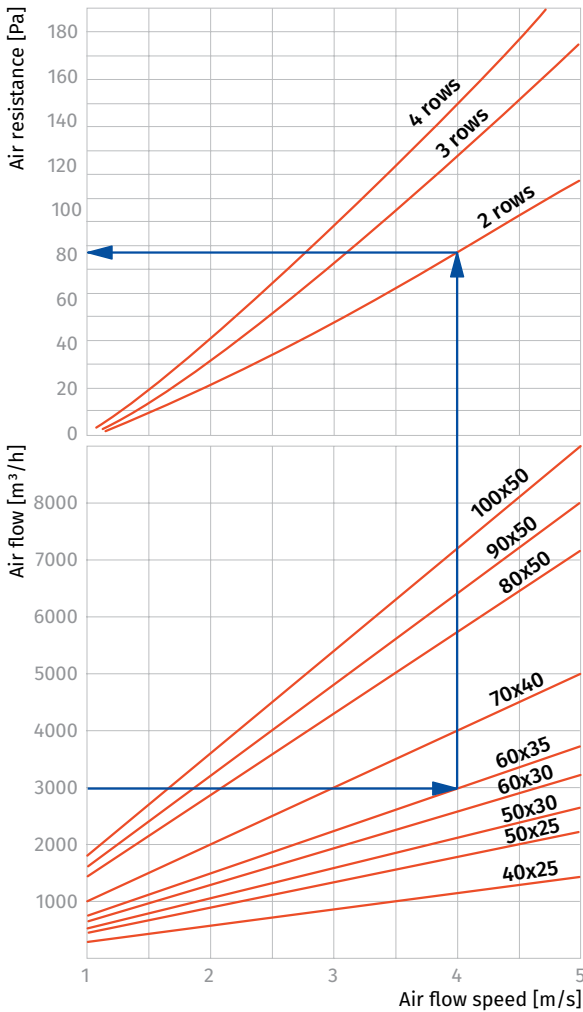

HEATERS

Water heaters calculation diagram

WKH 40x20-2

Air temperature downstream of the water heating coils [°C]

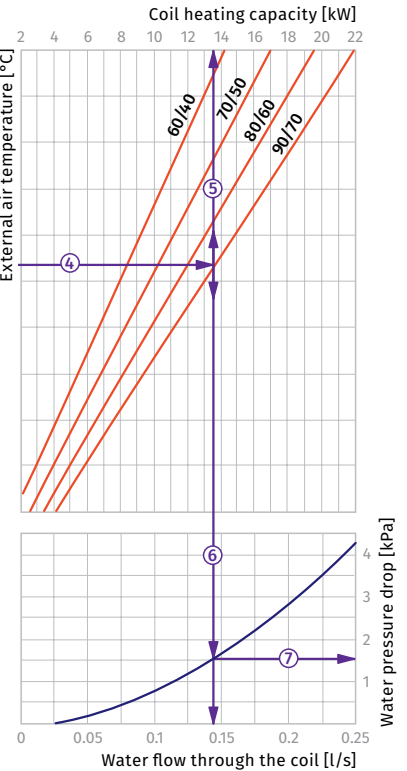
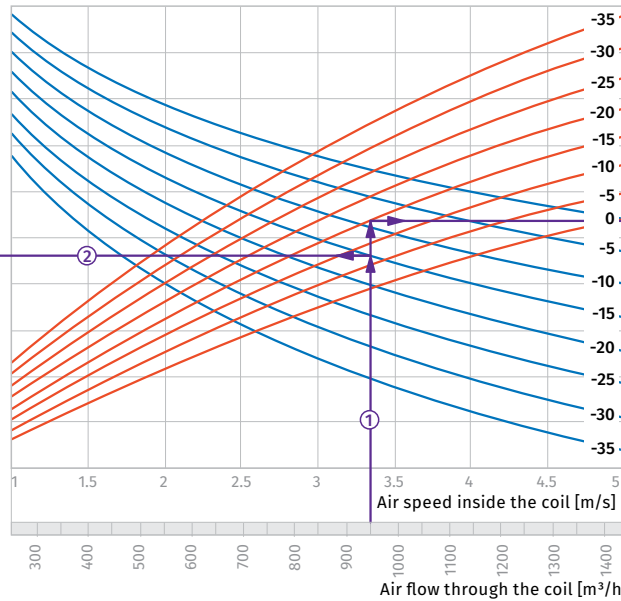
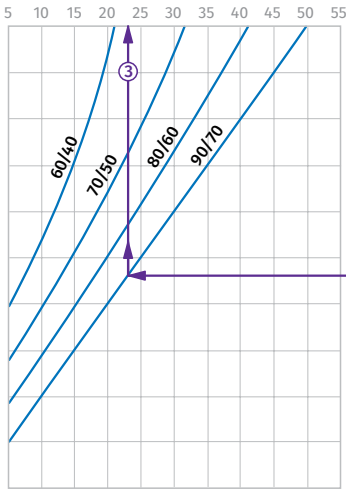

How to use water heater diagrams.

System Parameters: Air flow = 950 m³/h.
Outside air temperature = -15 °C.
Water temperature (in/out) = +90/+70 °C.
The air flow is 950 m³/h and the air speed in the heater is 3.35 m/s ①.

- To calculate the maximum air temperature find the intersection point of the air flow line ① with the rated outer temperature shown in blue line (e.g., -15 °C) and draw the line ② to the left until it crosses the water in/out temperature curve (e.g., +90/+70). From this point draw a vertical line to the supply air temperature downstream of the heater (+23 °C) ③.

- To calculate the heater power find the intersection point of the air flow ① with the rated winter temperature shown in red line (e.g., -15 °C) and draw the line ④ to the right until it crosses the water in/out temperature curve (e.g., +90/+70). From this point draw a vertical line to the heater power axis (13.5 kW) ⑤.

- To calculate the required water flow in the heater prolong this line ⑥ downwards to the water flow axis (0.14 l/s).
- To calculate the water pressure drop in the heater find the intersection point of the line ⑥ with the pressure loss curve and prolong the line ⑦ to the right on the water pressure drop axis (1.5 kPa).

WKH 40x20-4

Air temperature downstream of the water heating coils [°C]

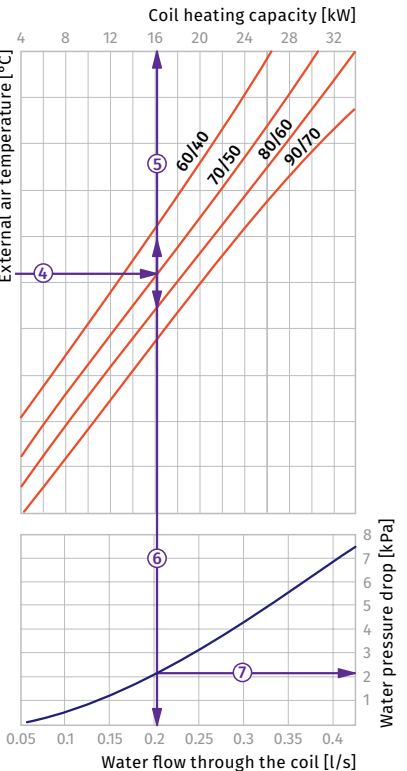
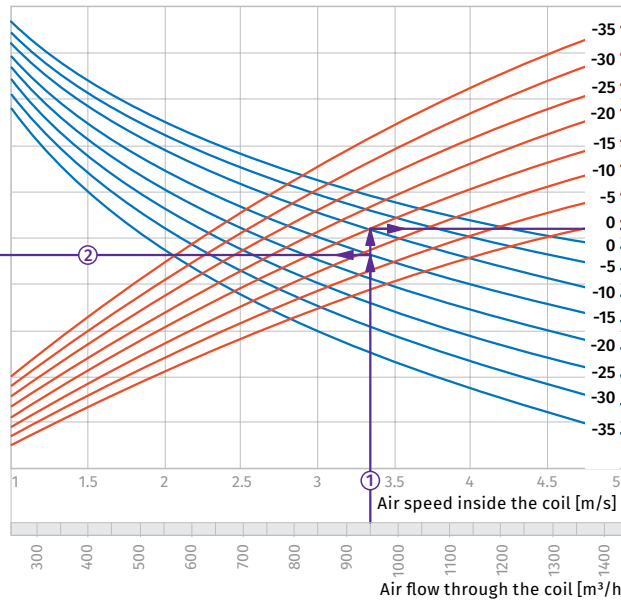
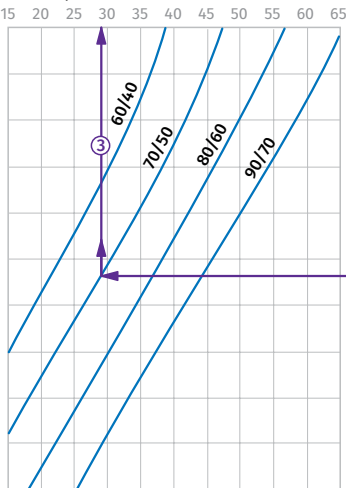

How to use water heater diagrams.

System Parameters: Air flow = 250 m³/h.
Outside air temperature = -15 °C.
Water temperature (in/out) = +70/+50 °C.
The air flow is 250 m³/h and the air speed in the heater is 3.35 m/s ①.

- To calculate the maximum air temperature find the intersection point of the air flow line ① with the rated outer temperature shown in blue line (e.g., -15 °C) and draw the line ② to the left until it crosses the water in/out temperature curve (e.g., +70/+50). From this point draw a vertical line to the supply air temperature downstream of the heater (+29 °C) ③.

- To calculate the heater power find the intersection point of the air flow ① with the rated winter temperature shown in red line (e.g., -15 °C) and draw the line ④ to the right until it crosses the water in/out temperature curve (e.g., +70/+50). From this point draw a vertical line to the heater power axis (16.0 kW) ⑤.

- To calculate the required water flow in the heater prolong this line ⑥ downwards to the water flow axis (0.2 l/s).
- To calculate the water pressure drop in the heater find the intersection point of the line ⑥ with the pressure loss curve and prolong the line ⑦ to the right on the water pressure drop axis (2.1 kPa).

WKH 50x25-2

Air temperature downstream of the water heating coils [°C]

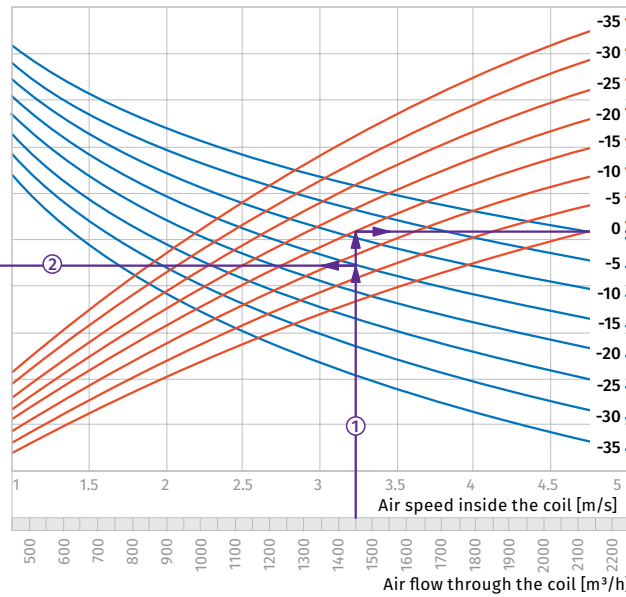
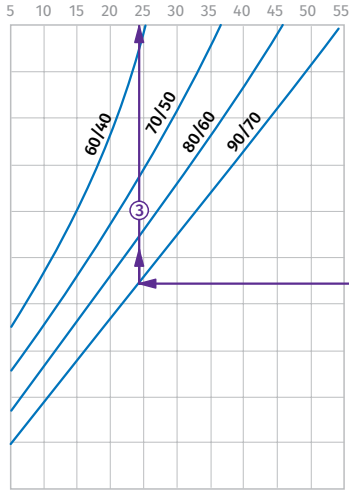

Coil heating capacity [kW]

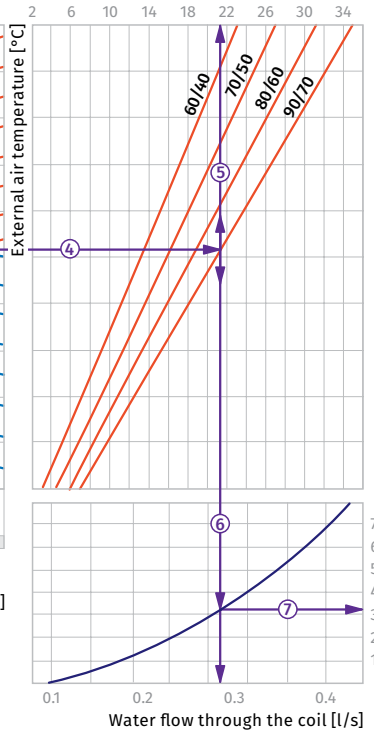

Water pressure drop [kPa]

How to use water heater diagrams.

System Parameters: Air flow = 1450 m³/h.
 Outside air temperature = -15 °C.
 Water temperature (in/out) = +90/+70 °C.
 The air flow is 1450 m³/h and the air speed in the heater is 3.2 m/s ①.

- To calculate the maximum air temperature find the intersection point of the air flow line ① with the rated outer temperature shown in blue line (e.g., -15 °C) and draw the line ② to the left until it crosses the water in/out temperature curve (e.g., +90/+70). From this point draw a vertical line to the supply air temperature downstream of the heater (+24 °C) ③.

- To calculate the heater power find the intersection point of the air flow ① with the rated winter temperature shown in red line (e.g., -15 °C) and draw the line ④ to the right until it crosses the water in/out temperature curve (e.g., +90/+70). From this point draw a vertical line to the heater power axis (21.5 kW) ⑤.

- To calculate the required water flow in the heater prolong this line ⑥ downwards to the water flow axis (0.27 l/s).
- To calculate the water pressure drop in the heater find the intersection point of the line ⑥ with the pressure loss curve and prolong the line ⑦ to the right on the water pressure drop axis (3.2 kPa).

WKH 50x30-4

Air temperature downstream of the water heating coils [°C]

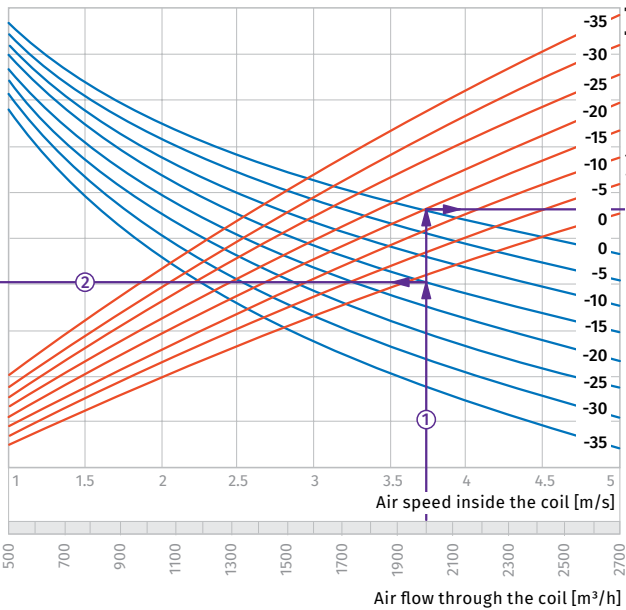
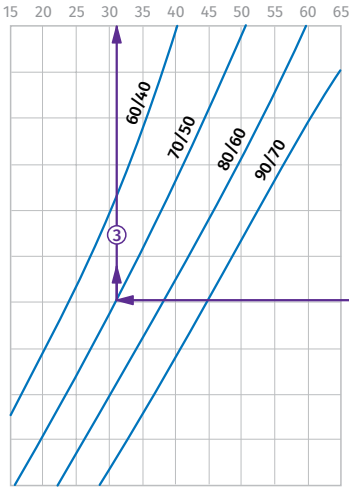

Coil heating capacity [kW]

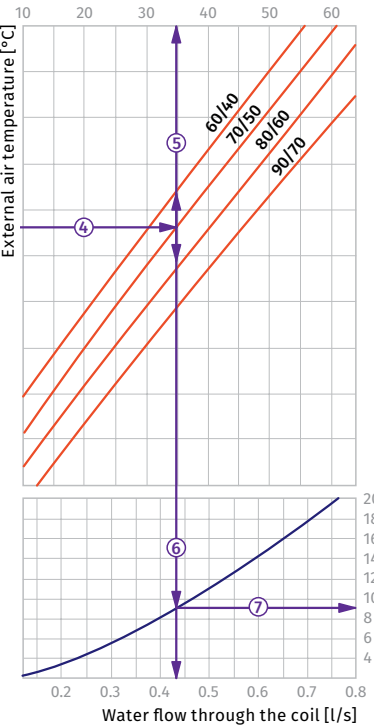

Wasserdruckabfall, kPa

How to use water heater diagrams.

System Parameters: Air flow = 2000 m³/h.
 Outside air temperature = -15 °C.
 Water temperature (in/out) = +70/+50 °C.
 The air flow is 2000 m³/h and the air speed in the heater is 3.75 m/s ①.

- To calculate the maximum air temperature find the intersection point of the air flow line ① with the rated outer temperature shown in blue line (e.g., -15 °C) and draw the line ② to the left until it crosses the water in/out temperature curve (e.g., +70/+50). From this point draw a vertical line to the supply air temperature downstream of the heater (+31 °C) ③.

- To calculate the heater power find the intersection point of the air flow ① with the rated winter temperature shown in red line (e.g., -15 °C) and draw the line ④ to the right until it crosses the water in/out temperature curve (e.g., +70/+50). From this point draw a vertical line to the heater power axis (35.0 kW) ⑤.

- To calculate the required water flow in the heater prolong this line ⑥ downwards to the water flow axis (0.43 l/s).
- To calculate the water pressure drop in the heater find the intersection point of the line ⑥ with the pressure loss curve and prolong the line ⑦ to the right on the water pressure drop axis (9.0 kPa).

WKH 60x30-2

Air temperature downstream of the water heating coils [°C]

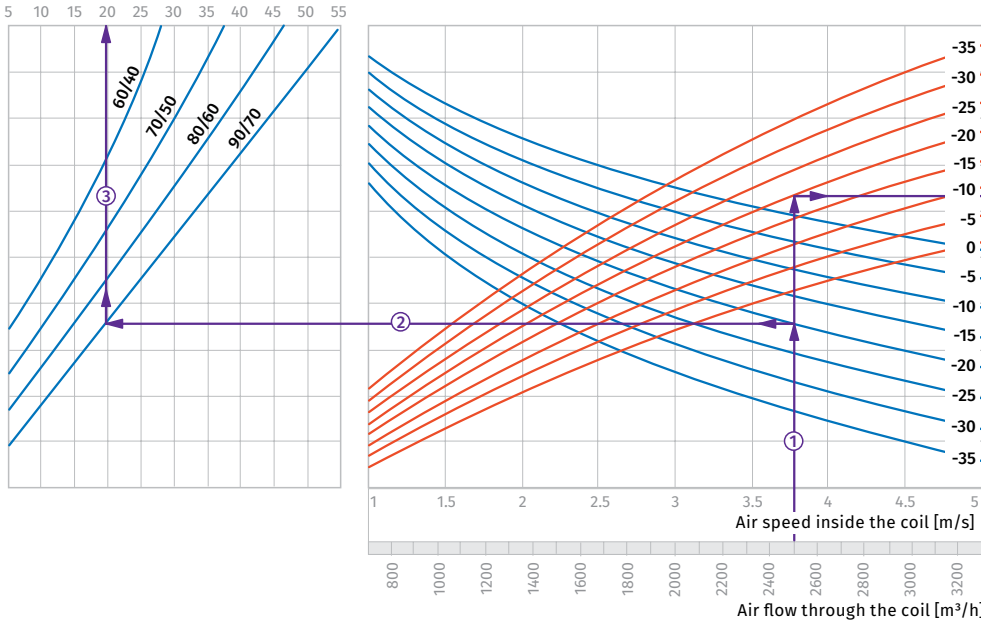

How to use water heater diagrams.

System Parameters: Air flow = 2500 m³/h.
Outside air temperature = -20 °C.
Water temperature (in/out) = +90/+70 °C.
The air flow is 2500 m³/h and the air speed in the heater is 3.75 m/s ①.

- To calculate the maximum air temperature find the intersection point of the air flow line ① with the rated outer temperature shown in blue line (e.g., -20 °C) and draw the line ② to the left until it crosses the water in/out temperature curve (e.g., +90/+70). From this point draw a vertical line to the supply air temperature downstream of the heater (+20 °C) ③.

- To calculate the heater power find the intersection point of the air flow ① with the rated winter temperature shown in red line (e.g., -20 °C) and draw the line ④ to the right until it crosses the water in/out temperature curve (e.g., +90/+70). From this point draw a vertical line to the heater power axis (37.0 kW) ⑤.

- To calculate the required water flow in the heater prolong this line ⑥ downwards to the water flow axis (0.46 l/s).
- To calculate the water pressure drop in the heater find the intersection point of the line ⑥ with the pressure loss curve and prolong the line ⑦ to the right on the water pressure drop axis (6.7 kPa).

WKH 60x30-4

Air temperature downstream of the water heating coils [°C]

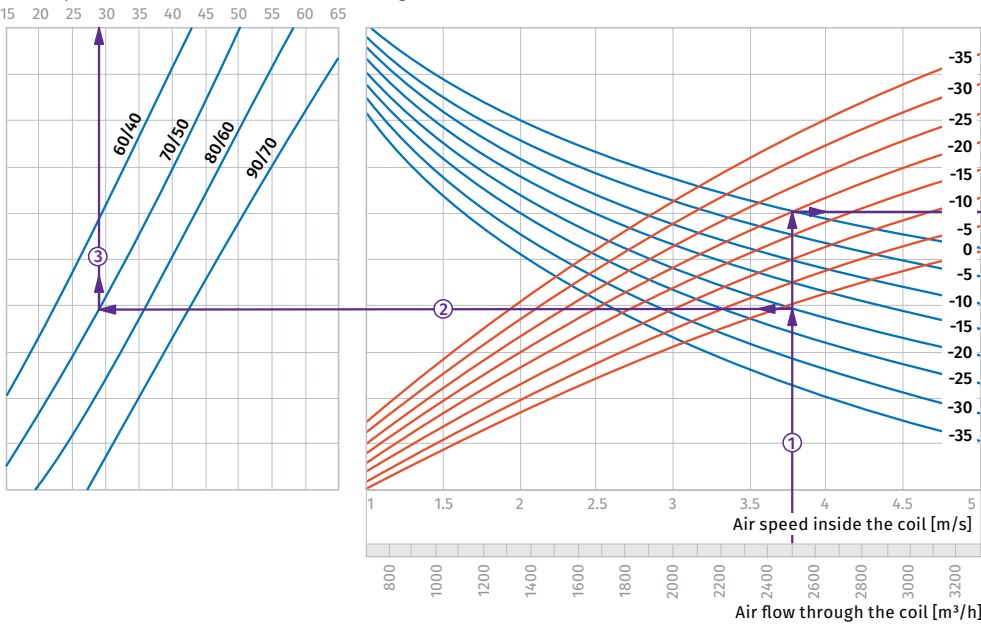

How to use water heater diagrams.

System Parameters: Air flow = 2500 m³/h.
Outside air temperature = -20 °C.
Water temperature (in/out) = +70/+50 °C.
The air flow is 2500 m³/h and the air speed in the heater is 3.75 m/s ①.

- To calculate the maximum air temperature find the intersection point of the air flow line ① with the rated outer temperature shown in blue line (e.g., -20 °C) and draw the line ② to the left until it crosses the water in/out temperature curve (e.g., +70/+50). From this point draw a vertical line to the supply air temperature downstream of the heater (+29 °C) ③.

- To calculate the heater power find the intersection point of the air flow ① with the rated winter temperature shown in red line (e.g., -20 °C) and draw the line ④ to the right until it crosses the water in/out temperature curve (e.g., +70/+50). From this point draw a vertical line to the heater power axis (48.0 kW) ⑤.

- To calculate the required water flow in the heater prolong this line ⑥ downwards to the water flow axis (0.6 l/s).
- To calculate the water pressure drop in the heater find the intersection point of the line ⑥ with the pressure loss curve and prolong the line ⑦ to the right on the water pressure drop axis (14.0 kPa).

WKH 60x35-2

Air temperature downstream of the water heating coils [°C]

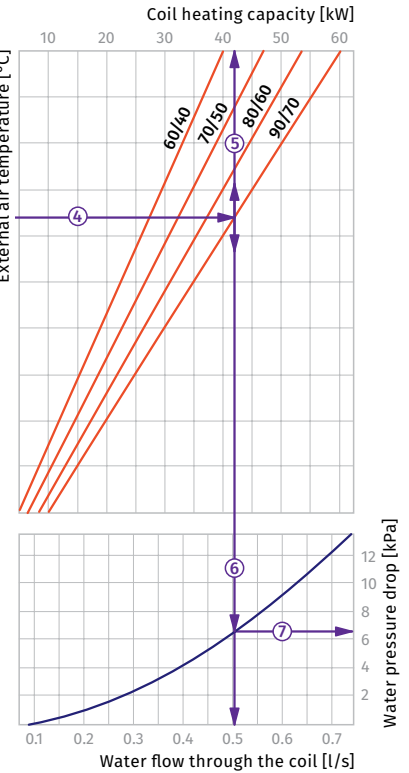
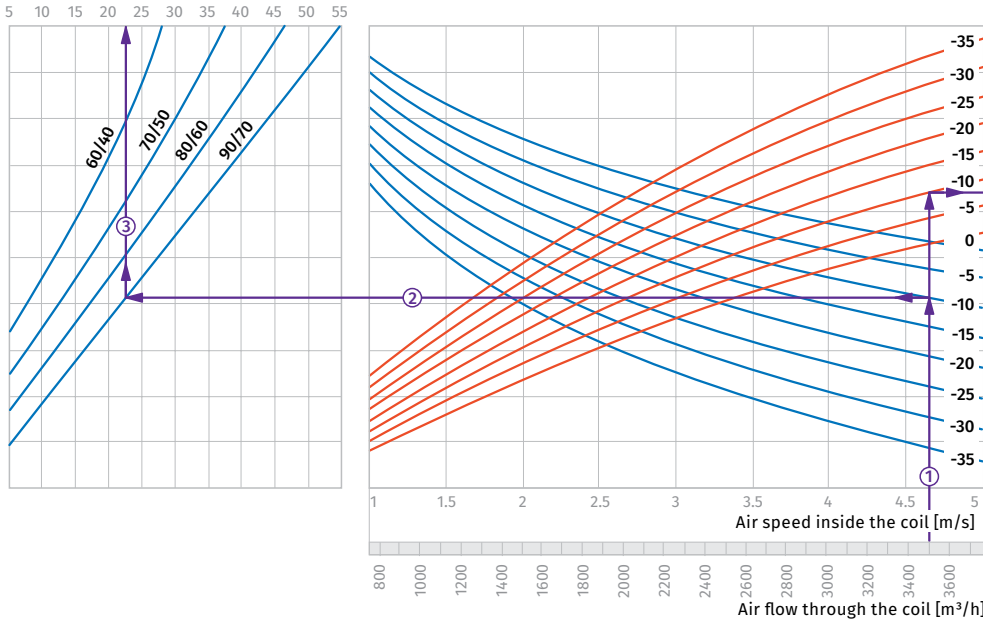

How to use water heater diagrams.

System Parameters: Air flow = 3500 m³/h.
 Outside air temperature = -10 °C.
 Water temperature (in/out) = +90/+70 °C.
 The air flow is 2500 m³/h and the air speed in the heater is 4.65 m/s ①.

- To calculate the maximum air temperature find the intersection point of the air flow line ① with the rated outer temperature shown in blue line (e.g., -10 °C) and draw the line ② to the left until it crosses the water in/out temperature curve (e.g., +90/+70). From this point draw a vertical line to the supply air temperature downstream of the heater (+22.5 °C) ③.

- To calculate the heater power find the intersection point of the air flow ① with the rated winter temperature shown in red line (e.g., -10 °C) and draw the line ④ to the right until it crosses the water in/out temperature curve (e.g., +90/+70). From this point draw a vertical line to the heater power axis (42.0 kW) ⑤.

- To calculate the required water flow in the heater prolong this line ⑥ downwards to the water flow axis (0.5 l/s).
- To calculate the water pressure drop in the heater find the intersection point of the line ⑥ with the pressure loss curve and prolong the line ⑦ to the right on the water pressure drop axis (6.5 kPa).

WKH 60x35-4

Air temperature downstream of the water heating coils [°C]

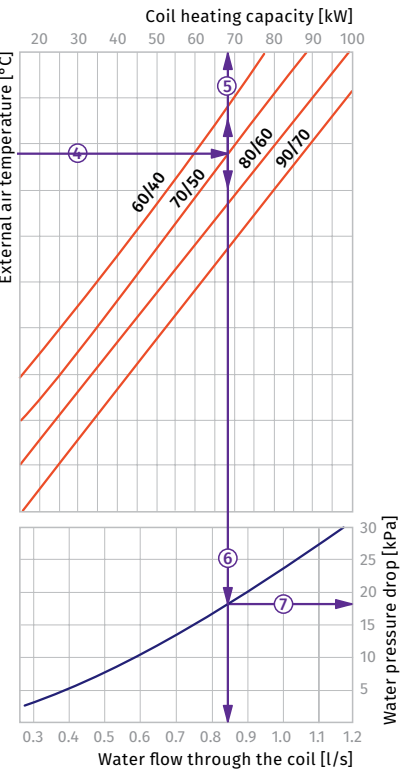
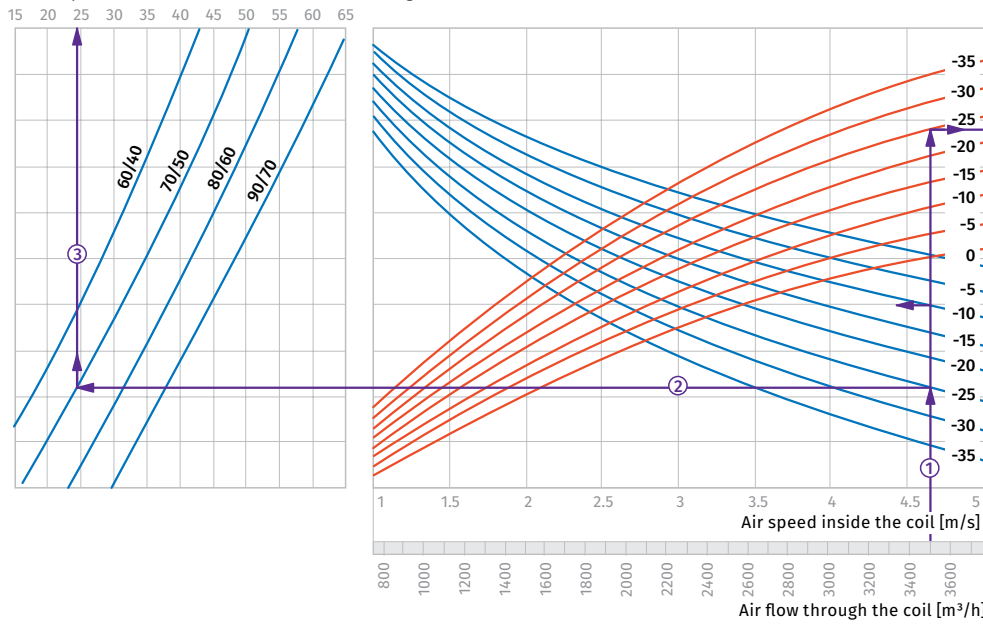

How to use water heater diagrams.

System Parameters: Air flow = 3500 m³/h.
 Outside air temperature = -25 °C.
 Water temperature (in/out) = +70/+50 °C.
 The air flow is 3500 m³/h and the air speed in the heater is 4.65 m/s ①.

- To calculate the maximum air temperature find the intersection point of the air flow line ① with the rated outer temperature shown in blue line (e.g., -25 °C) and draw the line ② to the left until it crosses the water in/out temperature curve (e.g., +70/+50). From this point draw a vertical line to the supply air temperature downstream of the heater (+24 °C) ③.

- To calculate the heater power find the intersection point of the air flow ① with the rated winter temperature shown in red line (e.g., -25 °C) and draw the line ④ to the right until it crosses the water in/out temperature curve (e.g., +70/+50). From this point draw a vertical line to the heater power axis (68.0 kW) ⑤.

- To calculate the required water flow in the heater prolong this line ⑥ downwards to the water flow axis (0.84 l/s).
- To calculate the water pressure drop in the heater find the intersection point of the line ⑥ with the pressure loss curve and prolong the line ⑦ to the right on the water pressure drop axis (18.0 kPa).

WKH 70x40-2

Air temperature downstream of the water heating coils [°C]

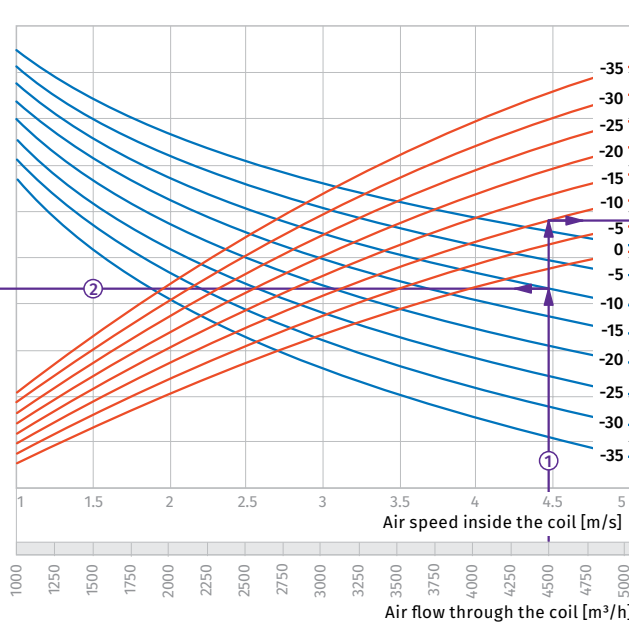
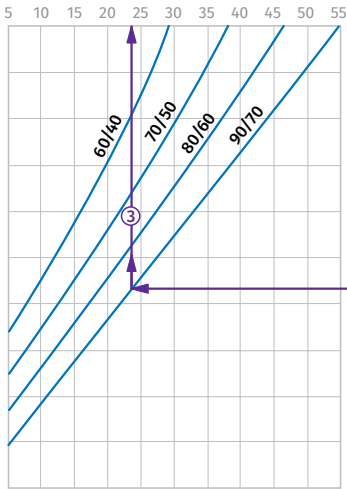

Coil heating capacity [kW]

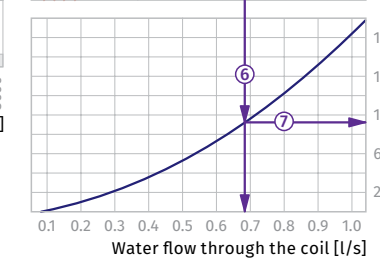
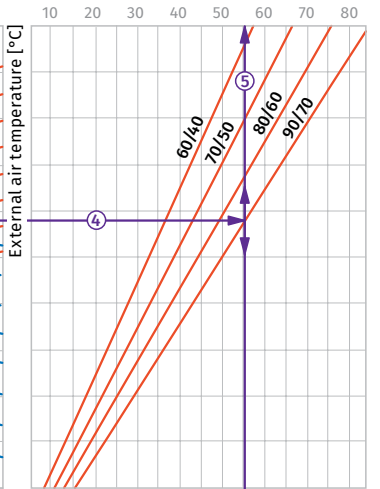

How to use water heater diagrams.

System Parameters: Air flow = 4500 m³/h.
Outside air temperature = -10 °C.
Water temperature (in/out) = +90/+70 °C.
The air flow is 2500 m³/h and the air speed in the heater is 4.45 m/s ①.

- To calculate the maximum air temperature find the intersection point of the air flow line ① with the rated outer temperature shown in blue line (e.g., -10 °C) and draw the line ② to the left until it crosses the water in/out temperature curve (e.g., +90/+70). From this point draw a vertical line to the supply air temperature downstream of the heater (+24 °C) ③.

- To calculate the heater power find the intersection point of the air flow ① with the rated winter temperature shown in red line (e.g., -10 °C) and draw the line ④ to the right until it crosses the water in/out temperature curve (e.g., +90/+70). From this point draw a vertical line to the heater power axis (55.0 kW) ⑤.

- To calculate the required water flow in the heater prolong this line ⑥ downwards to the water flow axis (0.68 l/s).
- To calculate the water pressure drop in the heater find the intersection point of the line ⑥ with the pressure loss curve and prolong the line ⑦ to the right on the water pressure drop axis (9.2 kPa).

WKH 70x40-3

Air temperature downstream of the water heating coils [°C]

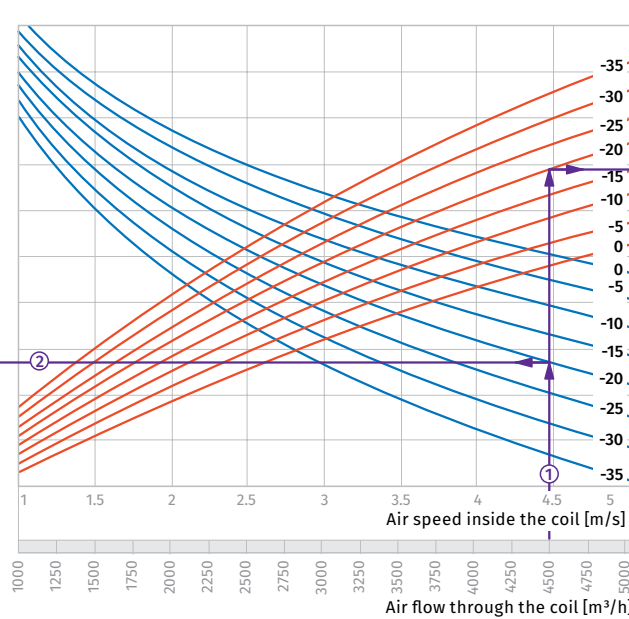
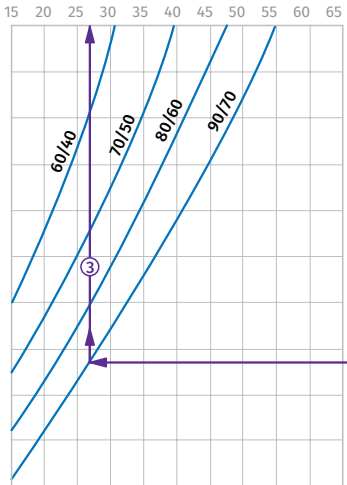

Coil heating capacity [kW]

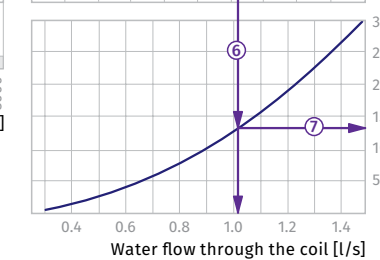
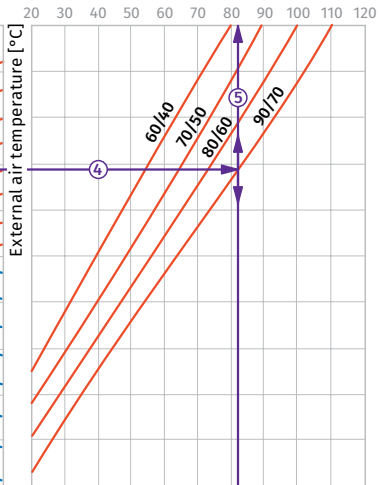

How to use water heater diagrams.

System Parameters: Air flow = 4500 m³/h.
Outside air temperature = -20 °C.
Water temperature (in/out) = +90/+70 °C.
The air flow is 2500 m³/h and the air speed in the heater is 4.45 m/s ①.

- To calculate the maximum air temperature find the intersection point of the air flow line ① with the rated outer temperature shown in blue line (e.g., -20 °C) and draw the line ② to the left until it crosses the water in/out temperature curve (e.g., +90/+70). From this point draw a vertical line to the supply air temperature downstream of the heater (+27 °C) ③.

- To calculate the heater power find the intersection point of the air flow ① with the rated winter temperature shown in red line (e.g., -20 °C) and draw the line ④ to the right until it crosses the water in/out temperature curve (e.g., +90/+70). From this point draw a vertical line to the heater power axis (82.0 kW) ⑤.

- To calculate the required water flow in the heater prolong this line ⑥ downwards to the water flow axis (1.02 l/s).
- To calculate the water pressure drop in the heater find the intersection point of the line ⑥ with the pressure loss curve and prolong the line ⑦ to the right on the water pressure drop axis (13.0 kPa).

WKH 80x50-2

Air temperature downstream of the water heating coils [°C]

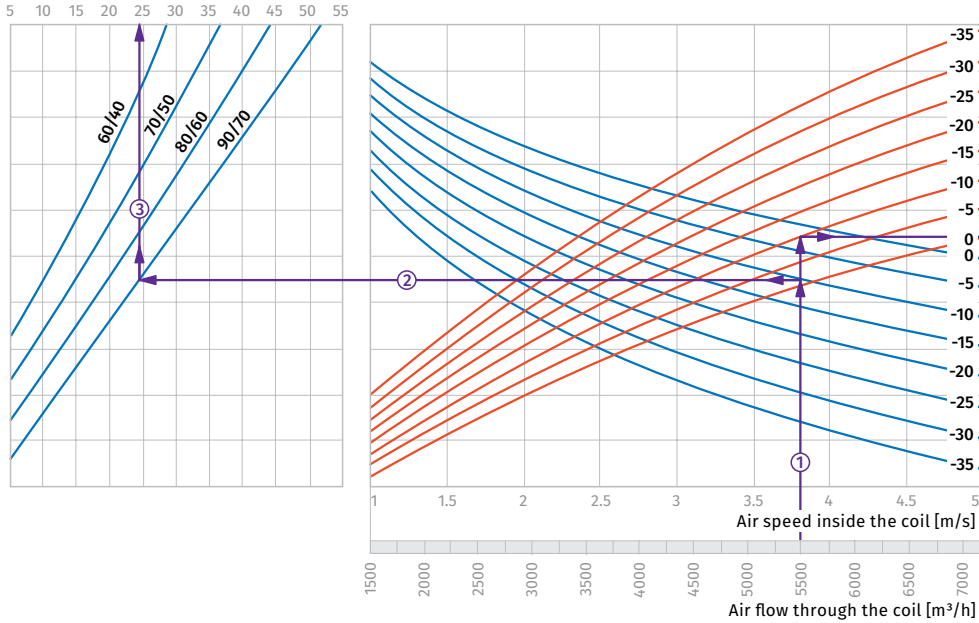

Coil heating capacity [kW]

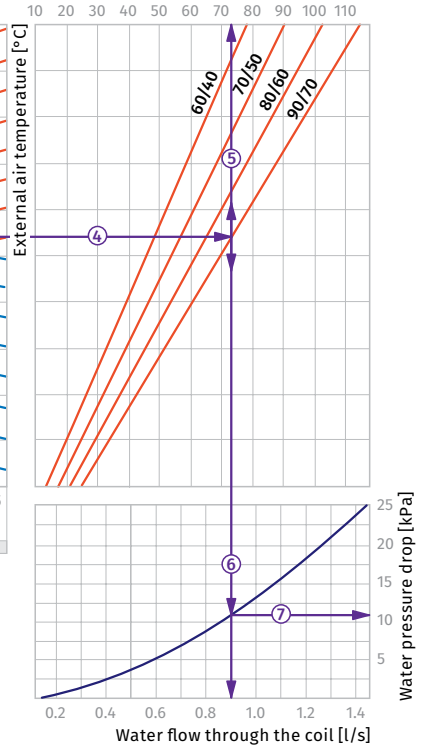

How to use water heater diagrams.

System Parameters: Air flow = 5500 m³/h.
 Outside air temperature = -10 °C.
 Water temperature (in/out) = +90/+70 °C.
 The air flow is 5500 m³/h and the air speed in the heater is 3.8 m/s ①.

- To calculate the maximum air temperature find the intersection point of the air flow line ① with the rated outer temperature shown in blue line (e.g., -10 °C) and draw the line ② to the left until it crosses the water in/out temperature curve (e.g., +90/+70). From this point draw a vertical line to the supply air temperature downstream of the heater (+24.5 °C) ③.

- To calculate the heater power find the intersection point of the air flow ① with the rated winter temperature shown in red line (e.g., -10 °C) and draw the line ④ to the right until it crosses the water in/out temperature curve (e.g., +90/+70). From this point draw a vertical line to the heater power axis (73.0 kW) ⑤.

- To calculate the required water flow in the heater prolong this line ⑥ downwards to the water flow axis (0.9 l/s).
- To calculate the water pressure drop in the heater find the intersection point of the line ⑥ with the pressure loss curve and prolong the line ⑦ to the right on the water pressure drop axis (11.0 kPa).

WKH 80x50-3

Air temperature downstream of the water heating coils [°C]

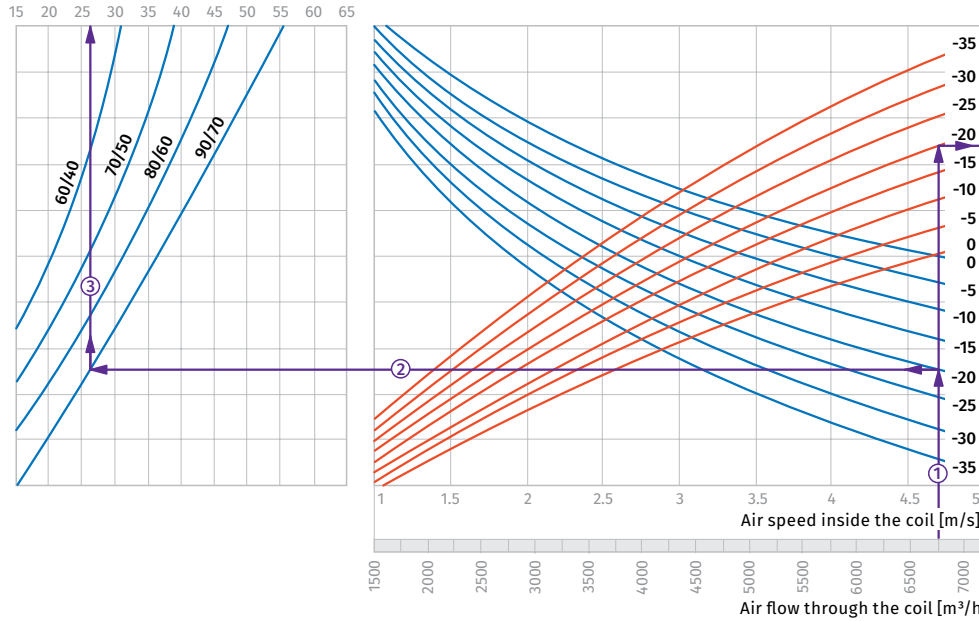

Coil heating capacity [kW]

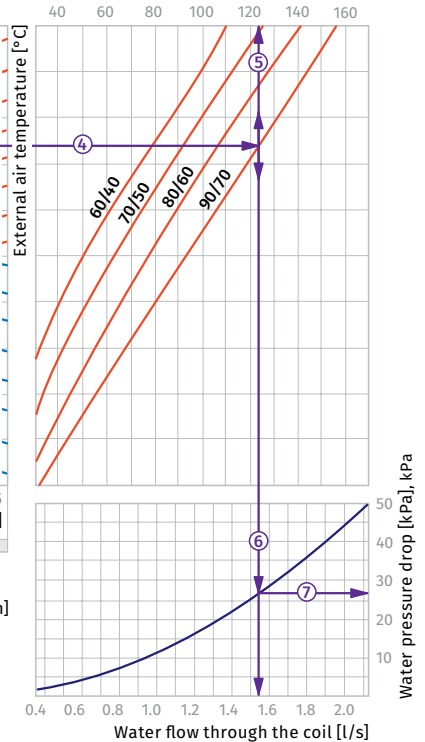

How to use water heater diagrams.

System Parameters: Air flow = 6750 m³/h.
 Outside air temperature = -20 °C.
 Water temperature (in/out) = +90/+70 °C.
 The air flow is 6750 m³/h and the air speed in the heater is 4.7 m/s ①.

- To calculate the maximum air temperature find the intersection point of the air flow line ① with the rated outer temperature shown in blue line (e.g., -20 °C) and draw the line ② to the left until it crosses the water in/out temperature curve (e.g., +90/+70). From this point draw a vertical line to the supply air temperature downstream of the heater (+26 °C) ③.

- To calculate the heater power find the intersection point of the air flow ① with the rated winter temperature shown in red line (e.g., -20 °C) and draw the line ④ to the right until it crosses the water in/out temperature curve (e.g., +90/+70). From this point draw a vertical line to the heater power axis (123.0 kW) ⑤.

- To calculate the required water flow in the heater prolong this line ⑥ downwards to the water flow axis (1.54 l/s).
- To calculate the water pressure drop in the heater find the intersection point of the line ⑥ with the pressure loss curve and prolong the line ⑦ to the right on the water pressure drop axis (27.0 kPa).

WKH 90x50-2

Air temperature downstream of the water heating coils [°C]

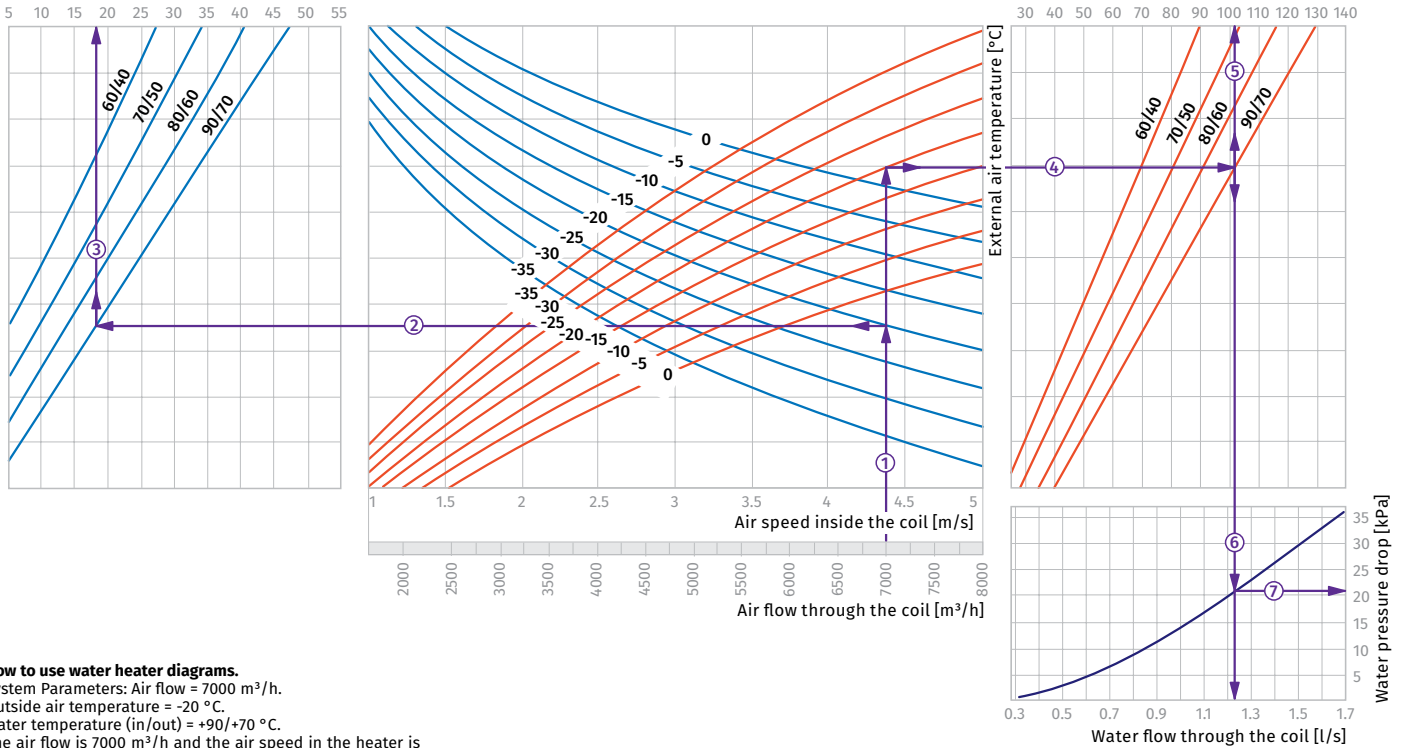

How to use water heater diagrams.

System Parameters: Air flow = 7000 m³/h.
Outside air temperature = -20 °C.
Water temperature (in/out) = +90/+70 °C.
The air flow is 7000 m³/h and the air speed in the heater is 4.4 m/s ①.

- To calculate the maximum air temperature find the intersection point of the air flow line ① with the rated outer temperature shown in blue line (e.g., -20 °C) and draw the line ② to the left until it crosses the water in/out temperature curve (e.g., +90/+70). From this point draw a vertical line to the supply air temperature downstream of the heater (+18 °C) ③.

- To calculate the heater power find the intersection point of the air flow ① with the rated winter temperature shown in red line (e.g., -20 °C) and draw the line ④ to the right until it crosses the water in/out temperature curve (e.g., +90/+70). From this point draw a vertical line to the heater power axis (102.0 kW) ⑤.

- To calculate the required water flow in the heater prolong this line ⑥ downwards to the water flow axis (1.23 l/s).
- To calculate the water pressure drop in the heater find the intersection point of the line ⑥ with the pressure loss curve and prolong the line ⑦ to the right on the water pressure drop axis (21.0 kPa).

WKH 90x50-3

Air temperature after heater passage [°C]

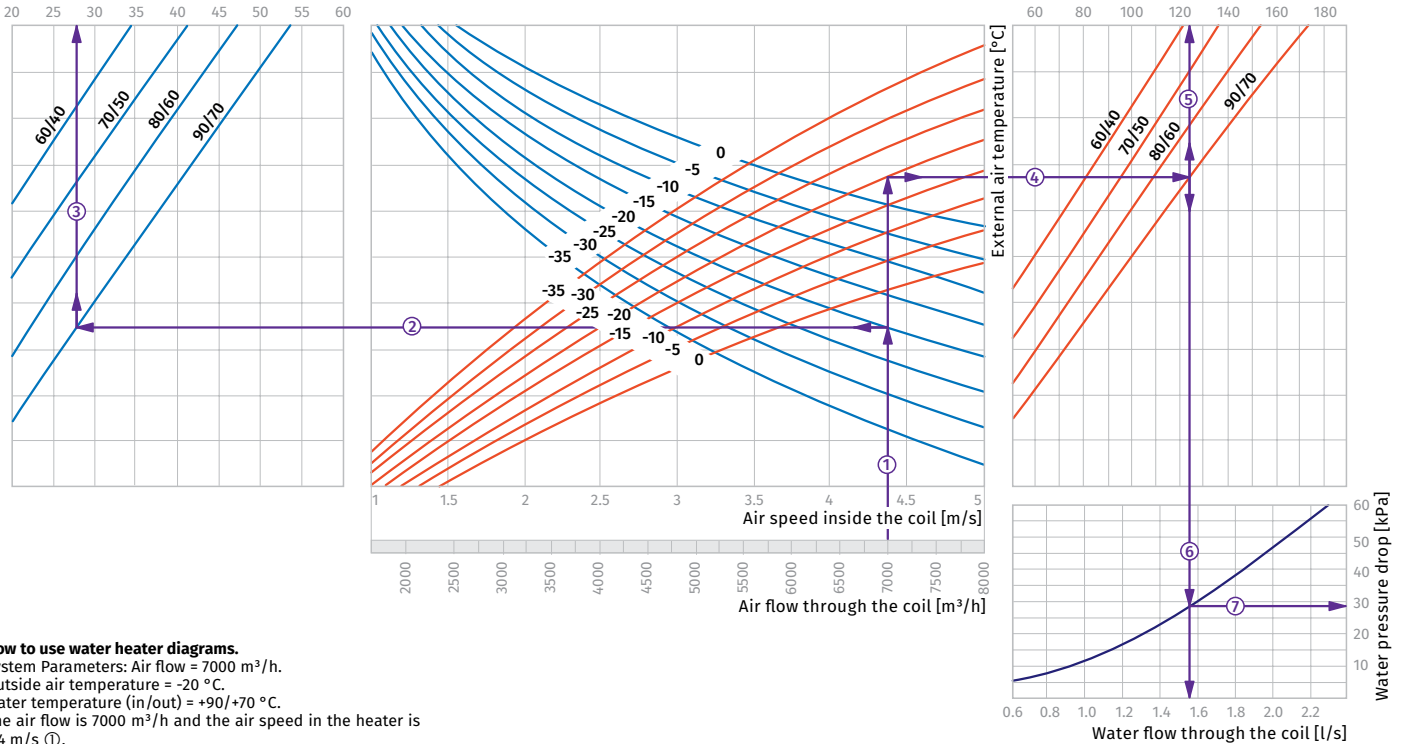

How to use water heater diagrams.

System Parameters: Air flow = 7000 m³/h.
Outside air temperature = -20 °C.
Water temperature (in/out) = +90/+70 °C.
The air flow is 7000 m³/h and the air speed in the heater is 4.4 m/s ①.

- To calculate the maximum air temperature find the intersection point of the air flow line ① with the rated outer temperature shown in blue line (e.g., -20 °C) and draw the line ② to the left until it crosses the water in/out temperature curve (e.g., +90/+70). From this point draw a vertical line to the supply air temperature downstream of the heater (+28 °C) ③.

- To calculate the heater power find the intersection point of the air flow ① with the rated winter temperature shown in red line (e.g., -20 °C) and draw the line ④ to the right until it crosses the water in/out temperature curve (e.g., +90/+70). From this point draw a vertical line to the heater power axis (124.0 kW) ⑤.

- To calculate the required water flow in the heater prolong this line ⑥ downwards to the water flow axis (1.55 l/s).
- To calculate the water pressure drop in the heater find the intersection point of the line ⑥ with the pressure loss curve and prolong the line ⑦ to the right on the water pressure drop axis (28.0 kPa).

WKH 100x50-2

Air temperature downstream of the water heating coils [°C]

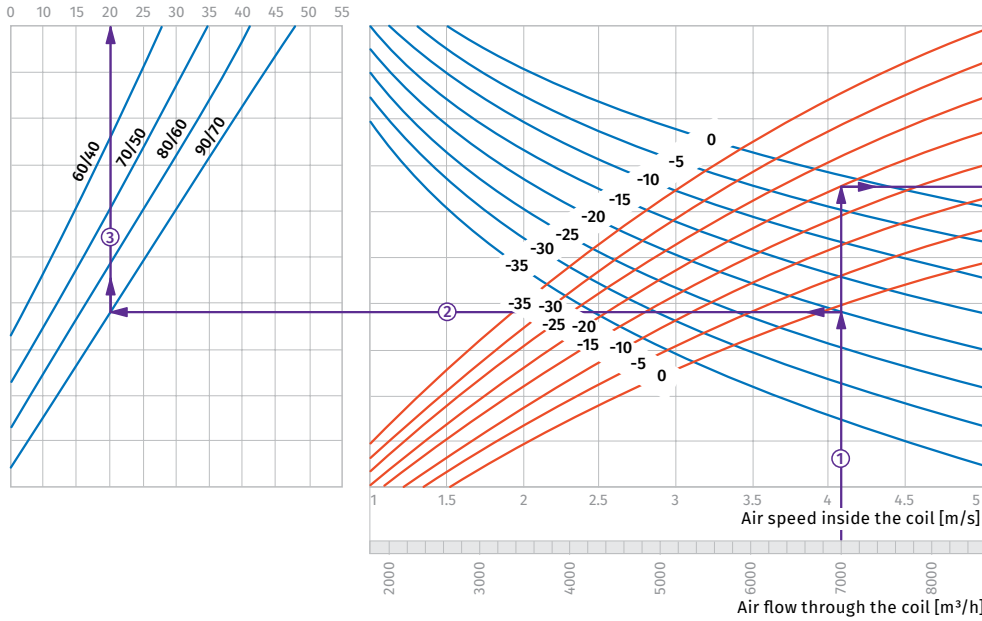

Coil heating capacity [kW]

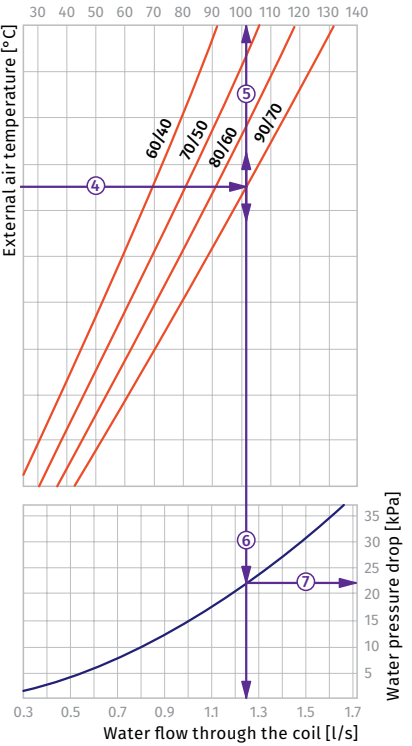

How to use water heater diagrams.

System Parameters: Air flow = 7000 m³/h.
 Outside air temperature = -20 °C.
 Water temperature (in/out) = +90/+70 °C.
 The air flow is 7000 m³/h and the air speed in the heater is 4.1 m/s ①.

- To calculate the maximum air temperature find the intersection point of the air flow line ① with the rated outer temperature shown in blue line (e.g., -20 °C) and draw the line ② to the left until it crosses the water in/out temperature curve (e.g., +90/+70). From this point draw a vertical line to the supply air temperature downstream of the heater (+20 °C) ③.

- To calculate the heater power find the intersection point of the air flow ① with the rated winter temperature shown in red line (e.g., -20 °C) and draw the line ④ to the right until it crosses the water in/out temperature curve (e.g., +90/+70). From this point draw a vertical line to the heater power axis (101.0 kW) ⑤.

- To calculate the required water flow in the heater prolong this line ⑥ downwards to the water flow axis (1.25 l/s).
- To calculate the water pressure drop in the heater find the intersection point of the line ⑥ with the pressure loss curve and prolong the line ⑦ to the right on the water pressure drop axis (22.0 kPa).

WKH 100x50-3

Air temperature downstream of the water heating coils [°C]

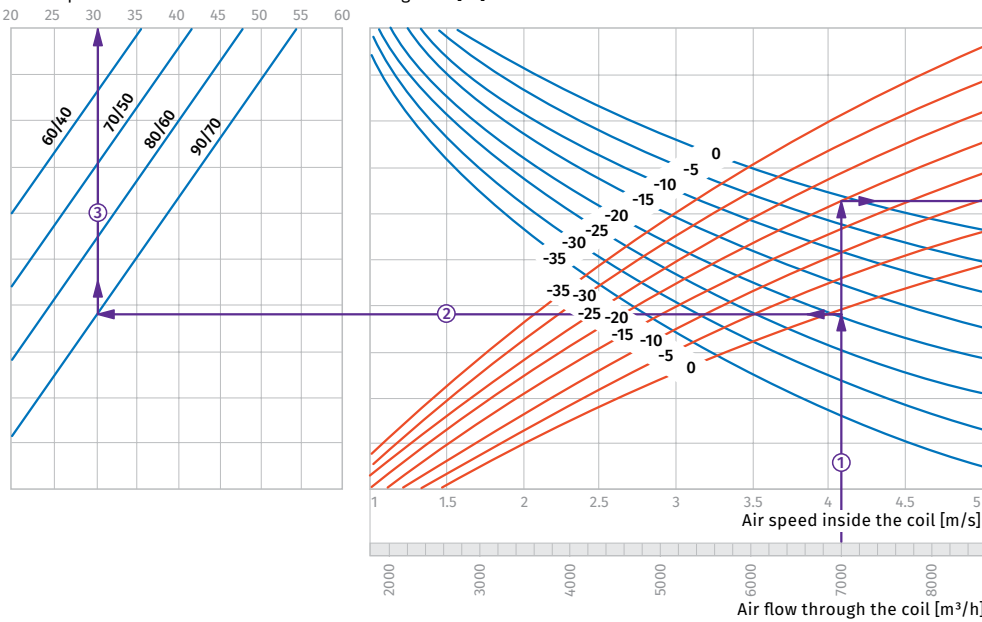

Coil heating capacity [kW]

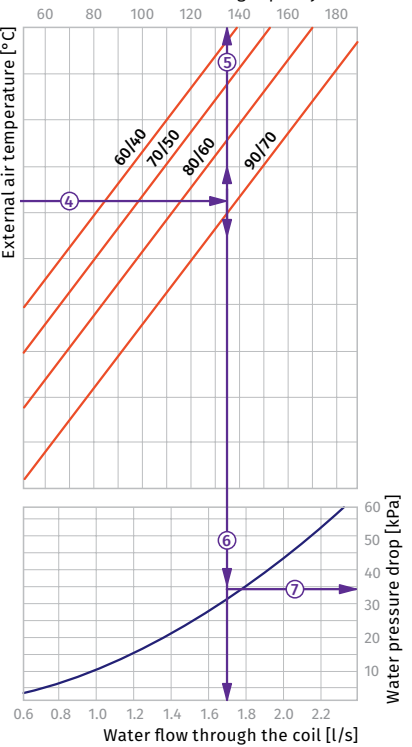

How to use water heater diagrams.

System Parameters: Air flow = 7000 m³/h.
 Outside air temperature = -20 °C.
 Water temperature (in/out) = +90/+70 °C.
 The air flow is 7000 m³/h and the air speed in the heater is 4.1 m/s ①.

- To calculate the maximum air temperature find the intersection point of the air flow line ① with the rated outer temperature shown in blue line (e.g., -20 °C) and draw the line ② to the left until it crosses the water in/out temperature curve (e.g., +90/+70). From this point draw a vertical line to the supply air temperature downstream of the heater (+30 °C) ③.

- To calculate the heater power find the intersection point of the air flow ① with the rated winter temperature shown in red line (e.g., -20 °C) and draw the line ④ to the right until it crosses the water in/out temperature curve (e.g., +90/+70). From this point draw a vertical line to the heater power axis (135.0 kW) ⑤.

- To calculate the required water flow in the heater prolong this line ⑥ downwards to the water flow axis (1.7 l/s).
- To calculate the water pressure drop in the heater find the intersection point of the line ⑥ with the pressure loss curve and prolong the line ⑦ to the right on the water pressure drop axis (34.0 kPa).

KWT

Plate heat exchangers for rectangular ducts

Use

- **KWT** plate heat exchanger with X-shaped air passage designed for exhaust air heat recovery in conditioning and ventilating systems.
- The heat exchangers are connected directly to the rectangular ducts both with parallel and perpendicular or diagonal ducting at 45°.
- Various connection modification are possible due to bend fittings which shall be ordered in the required quantity.
- The transported air shall not contain solid, fibrous, aggressive and explosive impurities.



Design

- The heat exchanger casing is made of galvanized steel. The surface of the heat exchanger consists of thin aluminium plates for efficient heat exchange.
- Some condensate quantity which can be generated at exhaust surface can be removed at the bottom removable panel.
- **KWT** heat exchangers equipment list includes connecting pipe on the bottom panel for condensate removing.

Accessory

BH BEND

- Designed for easy mounting of the heat exchanger in any modifications of the air duct.



SB C4 SUMMER BLOCK

- For the summer period the heat exchanger can be replaced with the summer block **SB C4** which performs no heat recovery but reduces pressure loss by 10 %. It is applied in systems without by-pass at the inlet and in systems with no cooling.

Overall dimensions [mm]

Model	B	B1	B2	H	H1	H2	H3	L	Weight [kg]
KWT 40x20	400	420	440	200	220	240	275	530	17.1
KWT 50x25	500	520	540	250	270	290	325	630	22.6
KWT 50x30	500	520	540	300	320	340	375	630	24.2
KWT 60x30	600	620	640	300	320	340	375	730	31.0
KWT 60x35	600	620	640	350	370	390	425	730	33.4
KWT 70x40	700	720	740	400	420	440	475	830	47.8
KWT 80x50	800	820	840	500	520	540	575	930	61.1
KWT 90x50	900	920	940	500	520	540	575	1130	78.8
KWT 100x50	1000	1020	1040	500	520	540	575	1130	78.3

Model	B	B1	B2	H	H1	H2	Weight [kg]
BH 40x20	400	420	440	200	220	240	2.2
BH 50x25	500	520	540	250	270	290	3.3
BH 50x30	500	520	540	300	320	340	3.5
BH 60x30	600	620	640	300	320	340	4.5
BH 60x35	600	620	640	350	370	390	4.7
BH 70x40	700	720	740	400	420	440	5.9
BH 80x50	800	820	840	500	520	540	7.5
BH 90x50	900	920	940	500	520	540	8.7
BH 100x50	1000	1020	1040	500	520	540	10.3

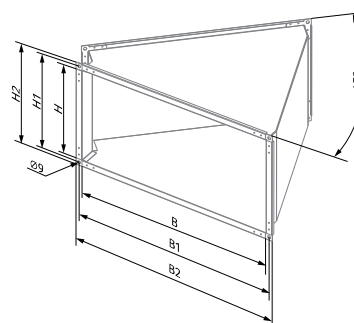
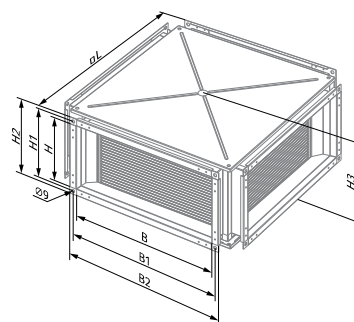

Technical data

- Heat recovery efficiency and air resistance in the air duct are the basic factors that determine the heat exchanger performance.

The thermal efficiency is calculated as following:

$$\eta = \frac{t_s - t_i}{t_e - t_i}$$

- t_s – supply air temperature after heat recuperation
- t_i – intake air temperature before heat recuperation
- t_e – extract air temperature before heat recuperation

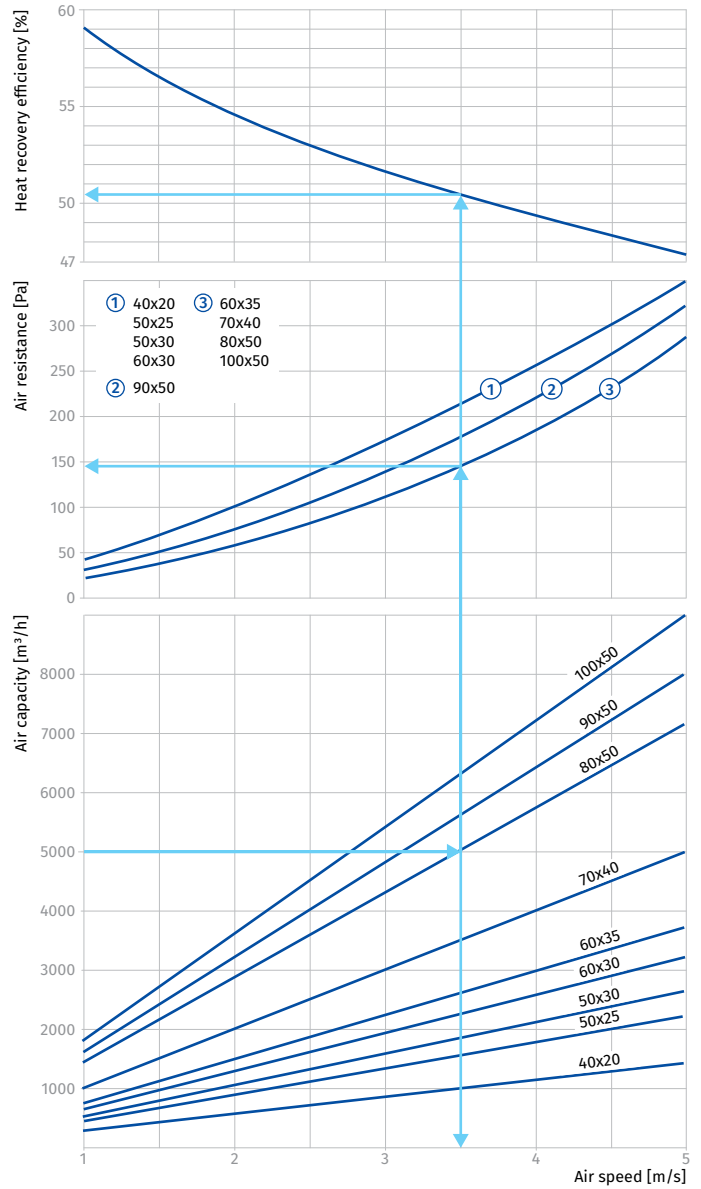

HEAT EXCHANGERS

Possible layout arrangements of KWT heat exchanger and BH bends:

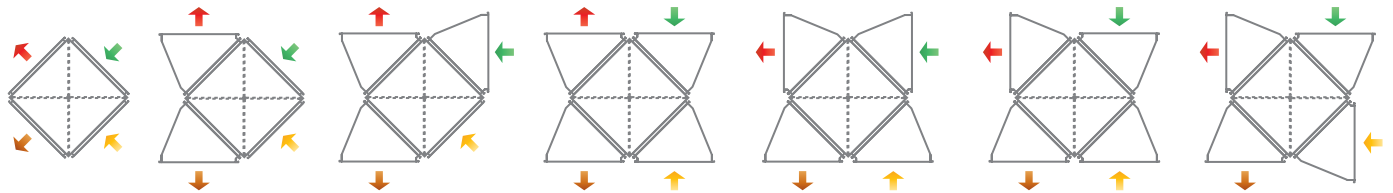

KWK

Duct water cooling units for rectangular air ducts

Use

- Supply air cooling for ventilation systems in various premises.
- Suitable for installation into supply ventilation or into air handling units to provide air cooling.



Design

- Galvanized steel casing.
- The cooling elements are made of copper tubes and aluminum plates.
- Available in three-coil modifications and rated for maximum operating pressure 1.5 MPa (15 bar).
- Polypropylene droplet separator and drain pan for condensate drainage and removal included.
- Droplet separator is efficient at an air flow not exceeding 4 m/s.

Mounting

- Only horizontal mounting by means of flanged connection. Air evacuation and condensate drainage must be provided.
- Air filter installation upstream of the cooling unit to prevent the unit soiling.
- Installation position must ensure uniform air flow distribution in the section.
- Mounting upstream or downstream of the supply fan. The minimum air duct length downstream of the fan must be 1–1.5 m to ensure air flow stabilization.
- The maximum cooling capacity is attained if the cooling unit is connected on counter-flow basis. The attached charts are valid for counter-flow connection.
- If water is used as a cooling agent, the cooling unit is suitable for indoor use only with the ambient temperature not below 0 °C.
- If antifreezing solution, for example, ethylene glycol solution, is used as a cooling agent, the cooling unit is suitable for outdoor use as well.
- While mounting the cooling unit provide condensate drainage through the U-trap. The U-trap height must be selected with respect to the total fan pressure, refer to the table and diagram below.

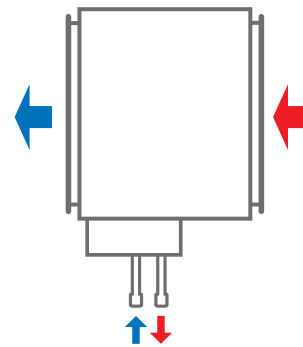

Counter air flow connection

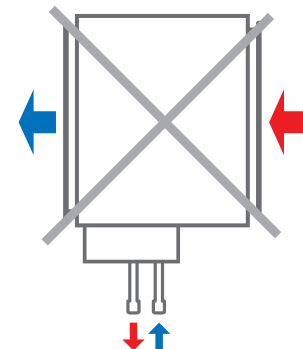

Air flow streamwise connection

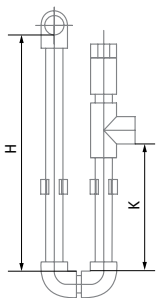

H [mm]	K [mm]	P [Pa]
100	55	600
200	105	1100
260	140	1400

H: U-trap height
K: drain height
P: Total fan pressure

- For a proper and safe operation of the cooling unit it should be connected to a control system for integral control and automatic cooling capacity regulation.

Designation key

Series	Flange size (WxH) [cm]	Number of water (glycol) coil rows
KWK	40x20; 50x25; 50x30; 60x30; 60x35; 70x40; 80x50; 90x50; 100x50	- 3

Overall dimensions [mm]

Model	B	B1	B2	H	H1	H2	L	K
KWK 40x20-3	400	440	470	200	295	124	56	G 3/4"
KWK 50x25-3	500	540	570	250	345	188	45	G 3/4"
KWK 50x30-3	500	540	570	300	395	252	56	G 3/4"
KWK 60x30-3	600	640	670	300	395	252	56	G 3/4"
KWK 60x35-3	600	640	670	350	445	268	56	G 3/4"
KWK 70x40-3	700	740	770	400	495	314	56	G 3/4"
KWK 80x50-3	800	840	870	500	595	442	56	G 3/4"
KWK 90x50-3	900	940	970	500	595	442	56	G 3/4"
KWK 100x50-3	1000	1040	1070	500	595	442	56	G 1"

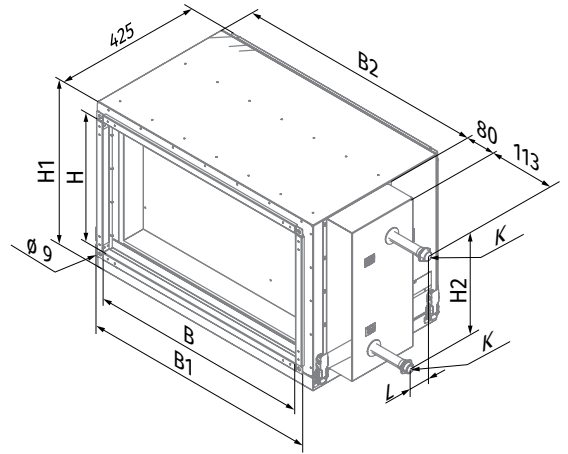

PRESSURE LOSSES IN WATER COOLING COILS

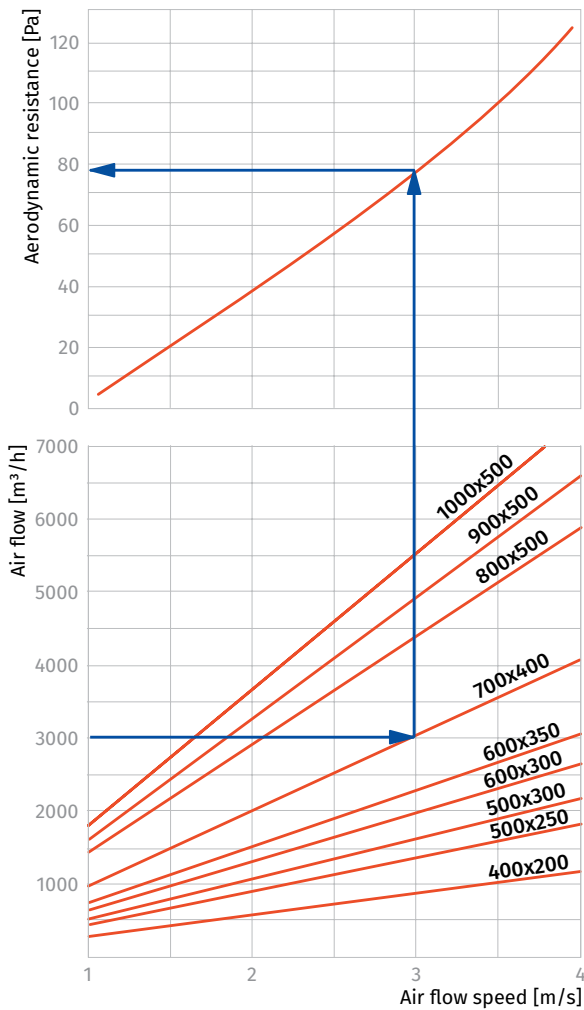

DX cooling unit calculation diagram

KWK 40x20-3

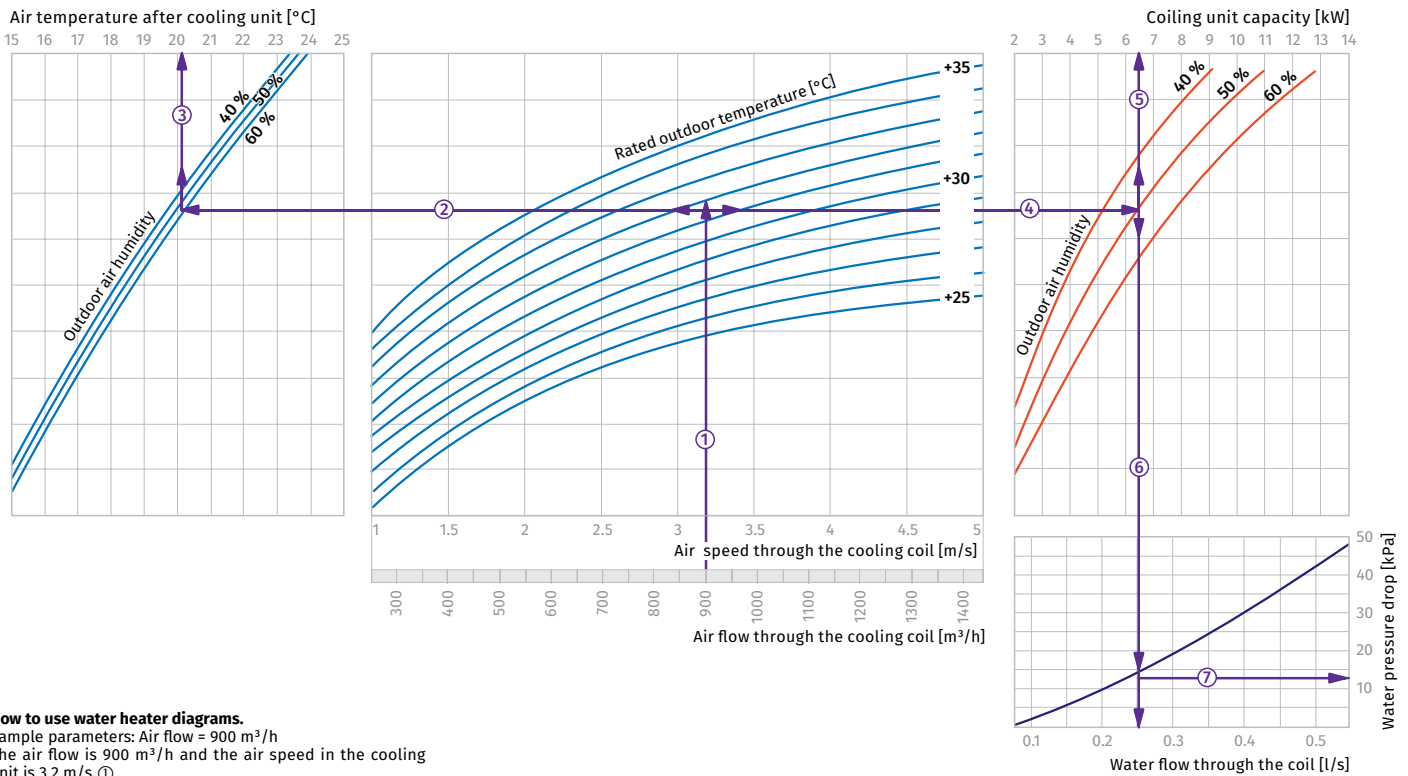

How to use water heater diagrams.

Sample parameters: Air flow = 900 m³/h

The air flow is 900 m³/h and the air speed in the cooling unit is 3.2 m/s ①.

- To calculate the coldest air temperature find the intersection point of the air flow line ① with the rated outdoor summer temperature shown in blue line (e.g., +32 °C) and draw the line ② to the left until it crosses the outdoor air humidity curve (e.g. 50 %). From this point draw a vertical line to the supply air temperature downstream of the cooling unit (+20.1 °C) ③.

- To calculate the power of the cooling unit find the intersection point of the air flow ① with the rated summer temperature (e.g., +32 °C) and draw the line ④ to the right until it crosses the air humidity curve (e.g., 50 %). From this point draw a vertical line to the cooling unit power axis (6.5 kW) ⑤.

- To calculate the required water flow in the cooling unit prolong this line ⑥ downwards to the water flow axis (0.26 l/s).
- To calculate the water pressure drop in the cooling unit find the intersection point of the line ⑥ with the pressure loss curve and prolong the line ⑦ to the right on the water pressure axis (15.0 kPa).

KWK 50x25-3

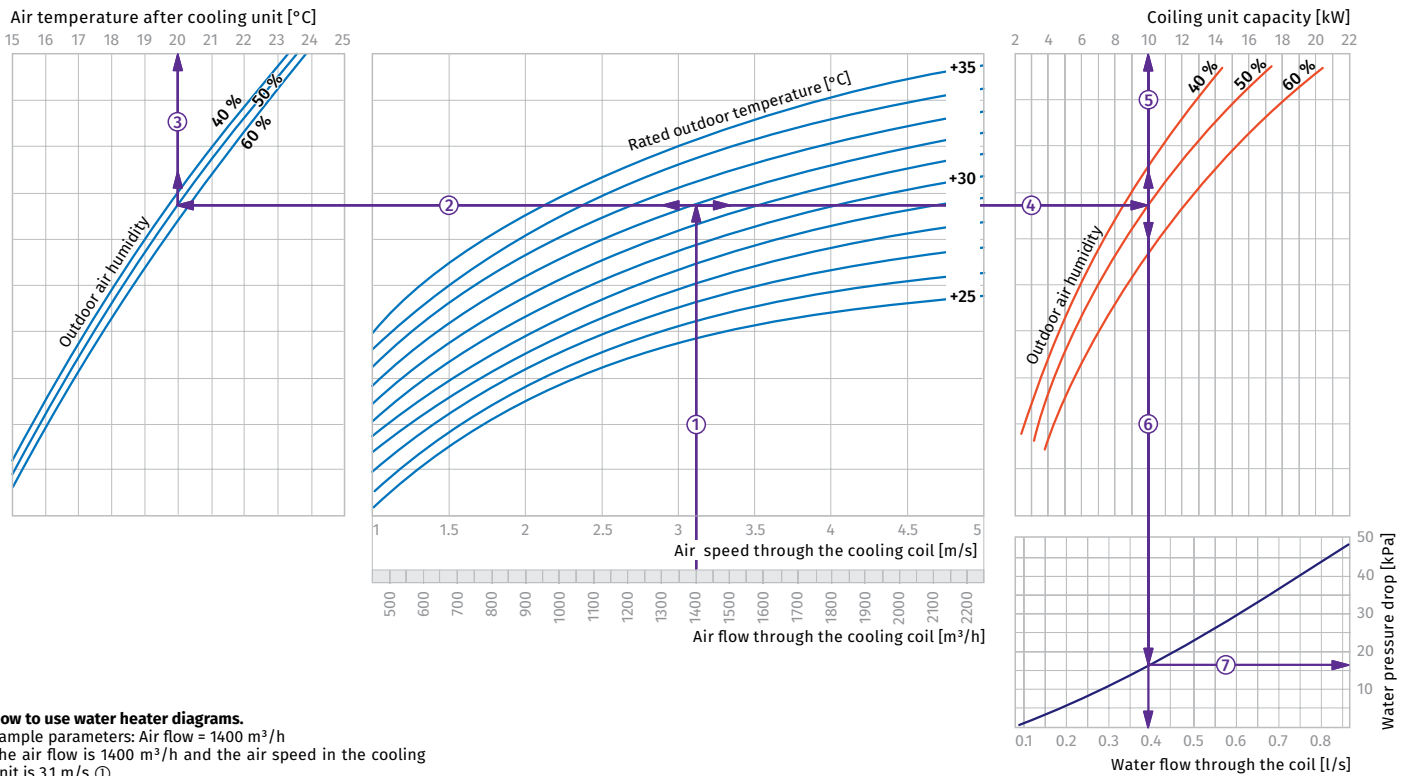

How to use water heater diagrams.

Sample parameters: Air flow = 1400 m³/h

The air flow is 1400 m³/h and the air speed in the cooling unit is 3.1 m/s ①.

- To calculate the coldest air temperature find the intersection point of the air flow line ① with the rated outdoor summer temperature shown in blue line (e.g., +32 °C) and draw the line ② to the left until it crosses the outdoor air humidity curve (e.g. 50 %). From this point draw a vertical line to the supply air temperature downstream of the cooling unit (+20 °C) ③.

- To calculate the power of the cooling unit find the intersection point of the air flow ① with the rated summer temperature (e.g., +32 °C) and draw the line ④ to the right until it crosses the air humidity curve (e.g., 50 %). From this point draw a vertical line to the cooling unit power axis (10.0 kW) ⑤.

- To calculate the required water flow in the cooling unit prolong this line ⑥ downwards to the water flow axis (0.4 l/s).
- To calculate the water pressure drop in the cooling unit find the intersection point of the line ⑥ with the pressure loss curve and prolong the line ⑦ to the right on the water pressure axis (17.0 kPa).

KWK 50x30-3

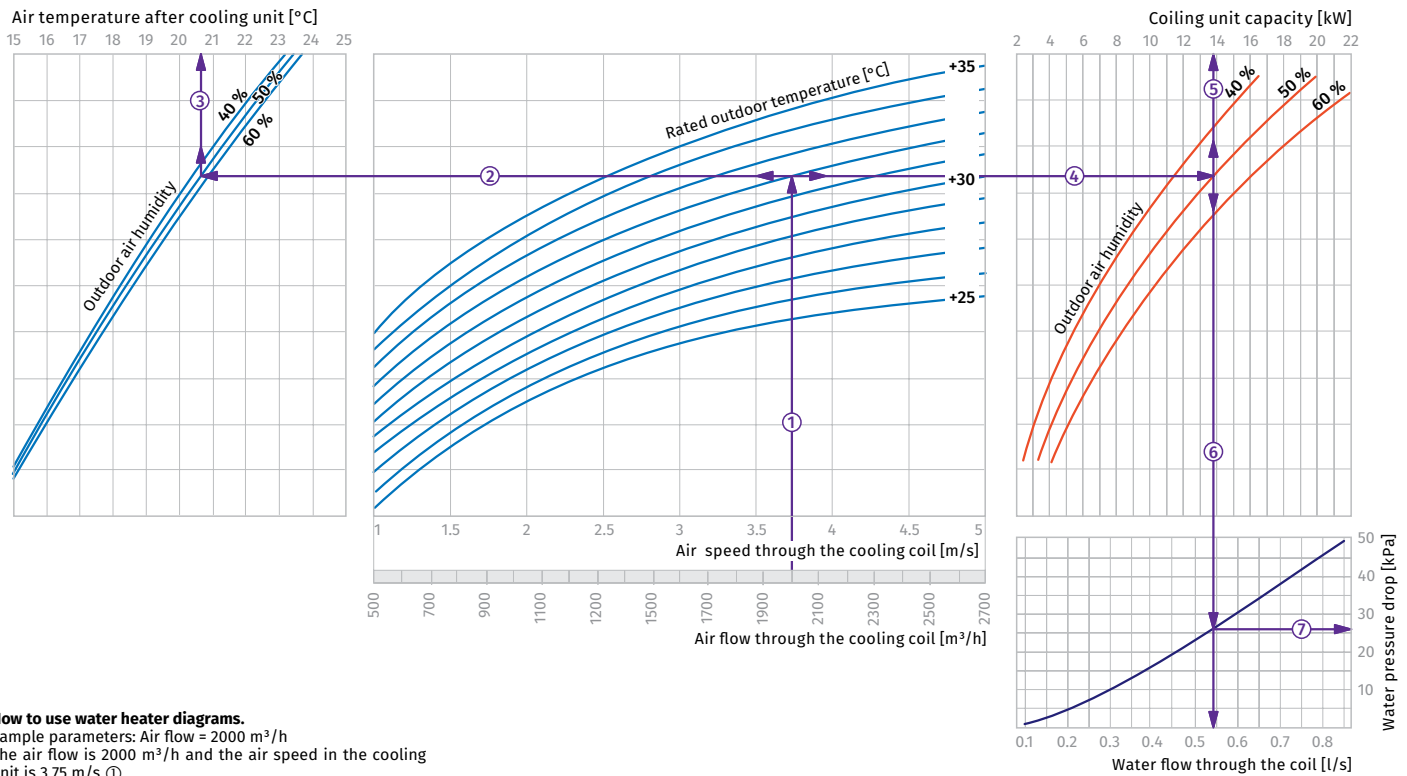

How to use water heater diagrams.

Sample parameters: Air flow = 2000 m³/h
The air flow is 2000 m³/h and the air speed in the cooling unit is 3.75 m/s ①.

- To calculate the coldest air temperature find the intersection point of the air flow line ① with the rated outer summer temperature shown in blue line (e.g., +32 °C) and draw the line ② to the left until it crosses the outdoor air humidity curve (e.g. 50 %). From this point draw a vertical line to the supply air temperature downstream of the cooling unit (+20.6 °C) ③.

- To calculate the power of the cooling unit find the intersection point of the air flow ① with the rated summer temperature (e.g., +32 °C) and draw the line ④ to the right until it crosses the air humidity curve (e.g., 50 %). From this point draw a vertical line to the cooling unit power axis (13.6 kW) ⑤.

- To calculate the required water flow in the cooling unit prolong this line ⑥ downwards to the water flow axis (0.54 l/s).
- To calculate the water pressure drop in the cooling unit find the intersection point of the line ⑥ with the pressure loss curve and prolong the line ⑦ to the right on the water pressure axis (27.0 kPa).

KWK 60x30-3

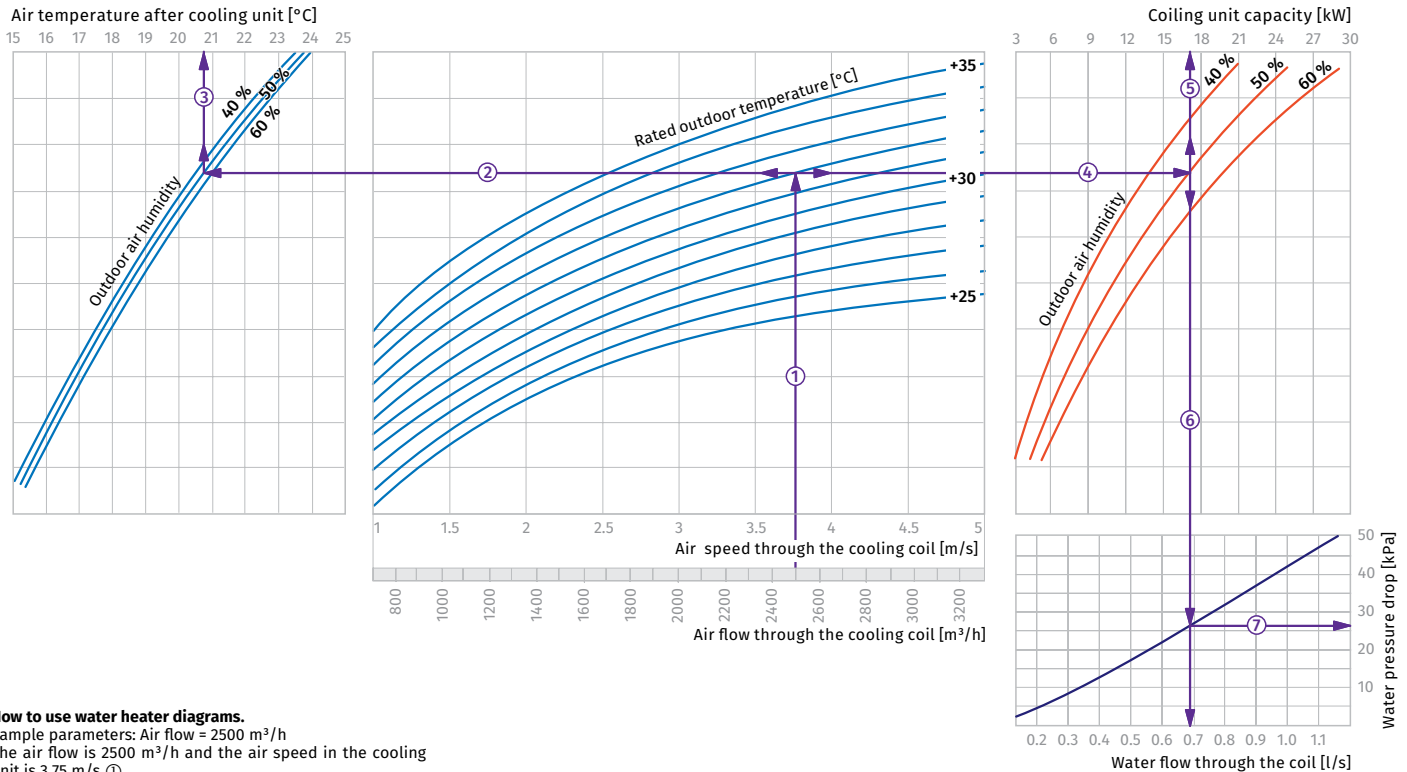

How to use water heater diagrams.

Sample parameters: Air flow = 2500 m³/h
The air flow is 2500 m³/h and the air speed in the cooling unit is 3.75 m/s ①.

- To calculate the coldest air temperature find the intersection point of the air flow line ① with the rated outer summer temperature shown in blue line (e.g., +32 °C) and draw the line ② to the left until it crosses the outdoor air humidity curve (e.g. 50 %). From this point draw a vertical line to the supply air temperature downstream of the cooling unit (+20.7 °C) ③.

- To calculate the power of the cooling unit find the intersection point of the air flow ① with the rated summer temperature (e.g., +32 °C) and draw the line ④ to the right until it crosses the air humidity curve (e.g., 50 %). From this point draw a vertical line to the cooling unit power axis (17.0 kW) ⑤.

- To calculate the required water flow in the cooling unit prolong this line ⑥ downwards to the water flow axis (0.68 l/s).
- To calculate the water pressure drop in the cooling unit find the intersection point of the line ⑥ with the pressure loss curve and prolong the line ⑦ to the right on the water pressure axis (27.0 kPa).

KWK 60x35-3

Air temperature after cooling unit [°C]

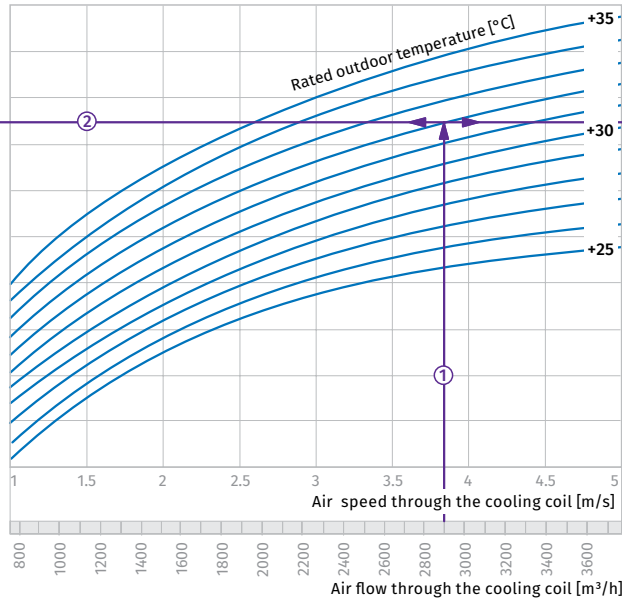
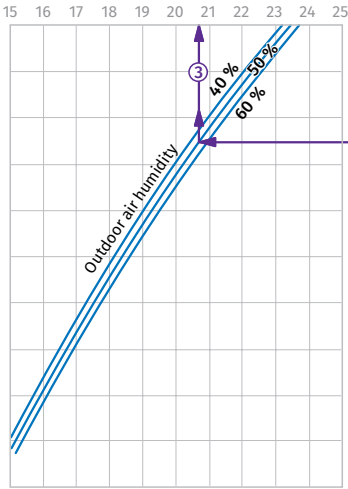

Coiling unit capacity [kW]

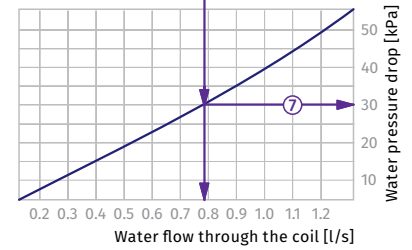
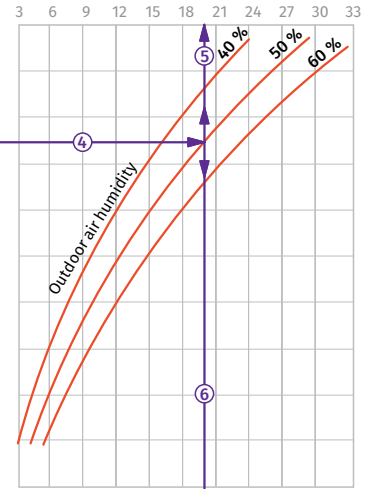

How to use water heater diagrams.

Sample parameters: Air flow = 2850 m³/h
The air flow is 2850 m³/h and the air speed in the cooling unit is 3.85 m/s ①.

- To calculate the coldest air temperature find the intersection point of the air flow line ① with the rated outer summer temperature shown in blue line (e.g., +32 °C) and draw the line ② to the left until it crosses the outdoor air humidity curve (e.g. 50 %). From this point draw a vertical line to the supply air temperature downstream of the cooling unit (+20.7 °C) ③.

- To calculate the power of the cooling unit find the intersection point of the air flow ① with the rated summer temperature (e.g., +32 °C) and draw the line ④ to the right until it crosses the air humidity curve (e.g., 50 %). From this point draw a vertical line to the cooling unit power axis (19.8 kW) ⑤.

- To calculate the required water flow in the cooling unit prolong this line ⑥ downwards to the water flow axis (0.78 l/s).
- To calculate the water pressure drop in the cooling unit find the intersection point of the line ⑥ with the pressure loss curve and prolong the line ⑦ to the right on the water pressure axis (30 kPa).

COOLERS

KWK 70x40-3

Air temperature after cooling unit [°C]

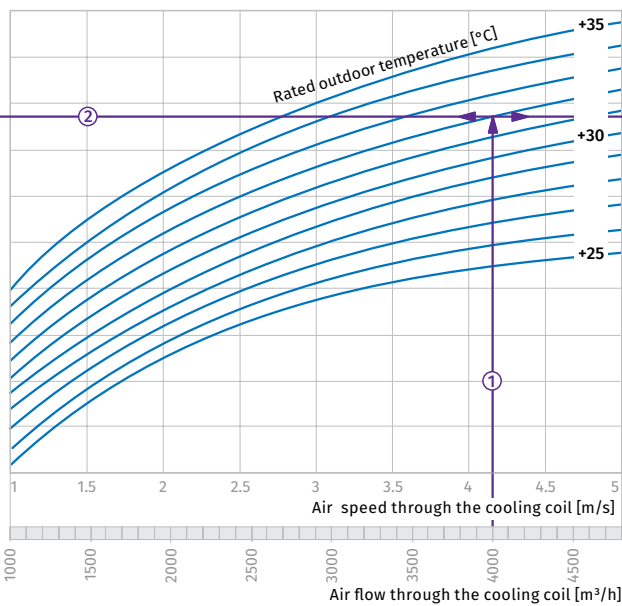
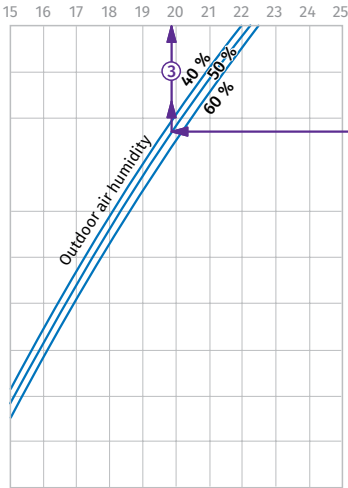

Coiling unit capacity [kW]

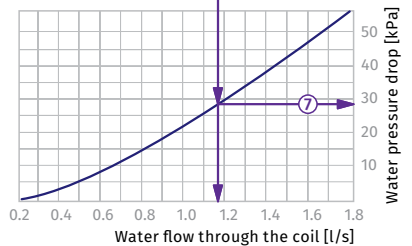
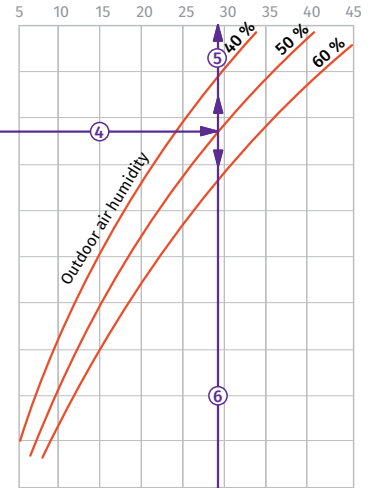

How to use water heater diagrams.

Sample parameters: Air flow = 4000 m³/h
The air flow is 4000 m³/h and the air speed in the cooling unit is 4.15 m/s ①.

- To calculate the coldest air temperature find the intersection point of the air flow line ① with the rated outer summer temperature shown in blue line (e.g., +32 °C) and draw the line ② to the left until it crosses the outdoor air humidity curve (e.g. 50 %). From this point draw a vertical line to the supply air temperature downstream of the cooling unit (+19.8 °C) ③.

- To calculate the power of the cooling unit find the intersection point of the air flow ① with the rated summer temperature (e.g., +32 °C) and draw the line ④ to the right until it crosses the air humidity curve (e.g., 50 %). From this point draw a vertical line to the cooling unit power axis (28.5 kW) ⑤.

- To calculate the required water flow in the cooling unit prolong this line ⑥ downwards to the water flow axis (1.14 l/s).
- To calculate the water pressure drop in the cooling unit find the intersection point of the line ⑥ with the pressure loss curve and prolong the line ⑦ to the right on the water pressure axis (28 kPa).

KWK 80x50-3

Air temperature after cooling unit [°C]

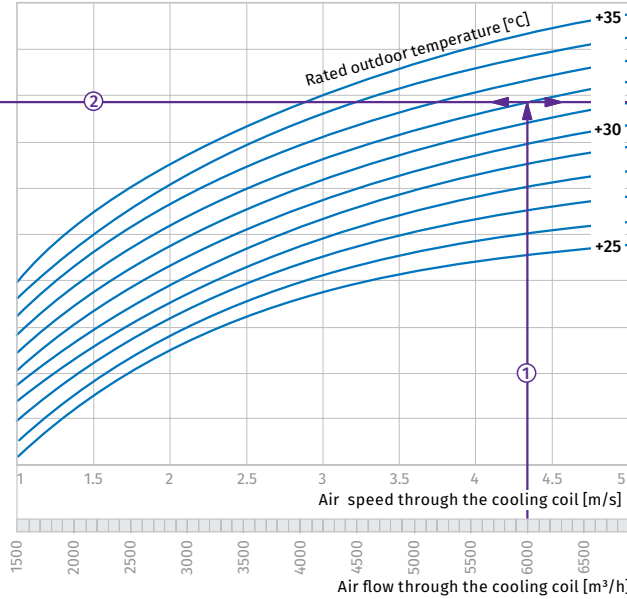
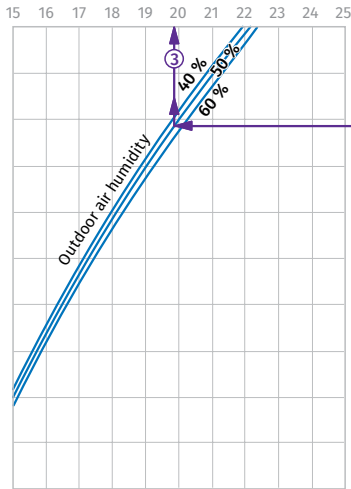

Coiling unit capacity [kW]

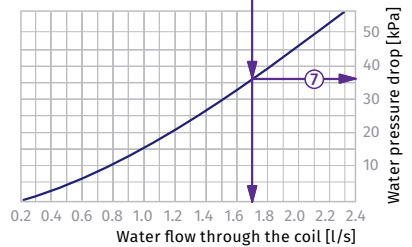
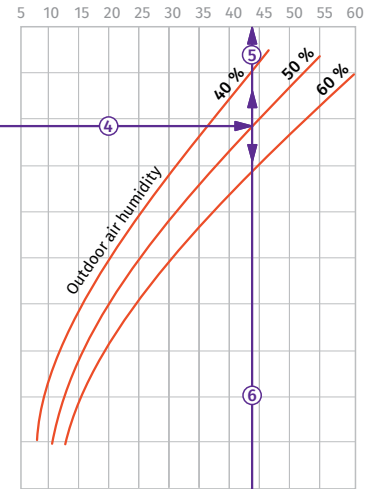

How to use water heater diagrams.

Sample parameters: Air flow = 6000 m³/h
The air flow is 6000 m³/h and the air speed in the cooling unit is 4.35 m/s ①.

- To calculate the coldest air temperature find the intersection point of the air flow line ① with the rated outer summer temperature shown in blue line (e.g., +32 °C) and draw the line ② to the left until it crosses the outdoor air humidity curve (e.g. 50 %). From this point draw a vertical line to the supply air temperature downstream of the cooling unit (+19.9 °C) ③.

- To calculate the power of the cooling unit find the intersection point of the air flow ① with the rated summer temperature (e.g., +32 °C) and draw the line ④ to the right until it crosses the air humidity curve (e.g., 50 %). From this point draw a vertical line to the cooling unit power axis (43 kW) ⑤.

- To calculate the required water flow in the cooling unit prolong this line ⑥ downwards to the water flow axis (1.7 l/s).
- To calculate the water pressure drop in the cooling unit find the intersection point of the line ⑥ with the pressure loss curve and prolong the line ⑦ to the right on the water pressure axis (36 kPa).

KWK 90x50-3

Air temperature after cooling unit [°C]

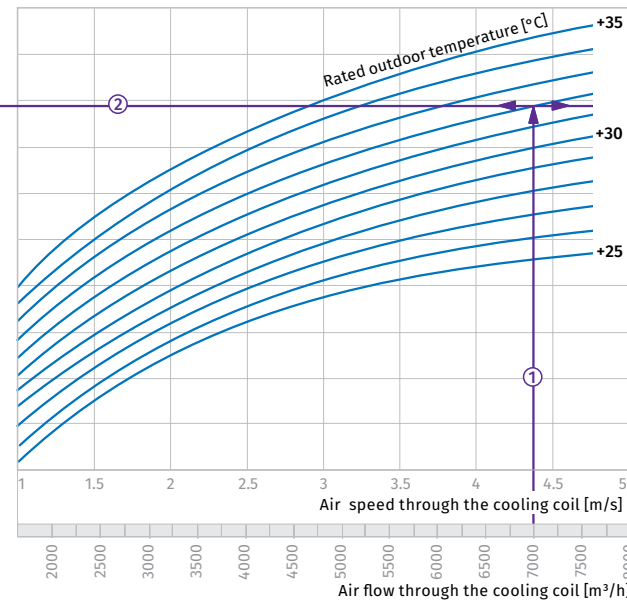
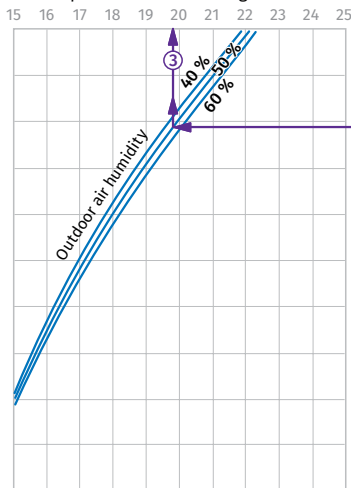

Coiling unit capacity [kW]

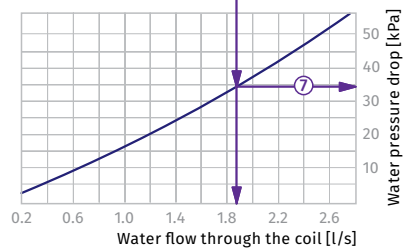
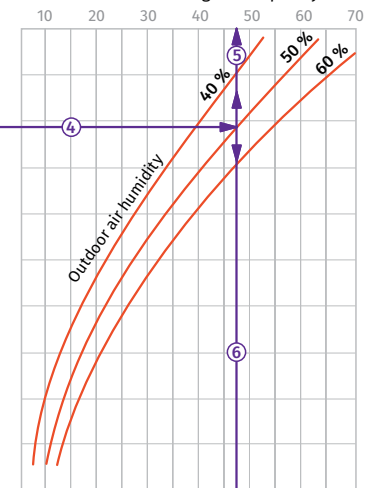

How to use water heater diagrams.

Sample parameters: Air flow = 7000 m³/h
The air flow is 7000 m³/h and the air speed in the cooling unit is 4.4 m/s ①.

- To calculate the coldest air temperature find the intersection point of the air flow line ① with the rated outer summer temperature shown in blue line (e.g., +32 °C) and draw the line ② to the left until it crosses the outdoor air humidity curve (e.g. 50 %). From this point draw a vertical line to the supply air temperature downstream of the cooling unit (+19.7 °C) ③.

- To calculate the power of the cooling unit find the intersection point of the air flow ① with the rated summer temperature (e.g., +32 °C) and draw the line ④ to the right until it crosses the air humidity curve (e.g., 50 %). From this point draw a vertical line to the cooling unit power axis (47 kW) ⑤.

- To calculate the required water flow in the cooling unit prolong this line ⑥ downwards to the water flow axis (1.9 l/s).
- To calculate the water pressure drop in the cooling unit find the intersection point of the line ⑥ with the pressure loss curve and prolong the line ⑦ to the right on the water pressure axis (34 kPa).

KWK 100x50-3

Air temperature after cooling unit [°C]

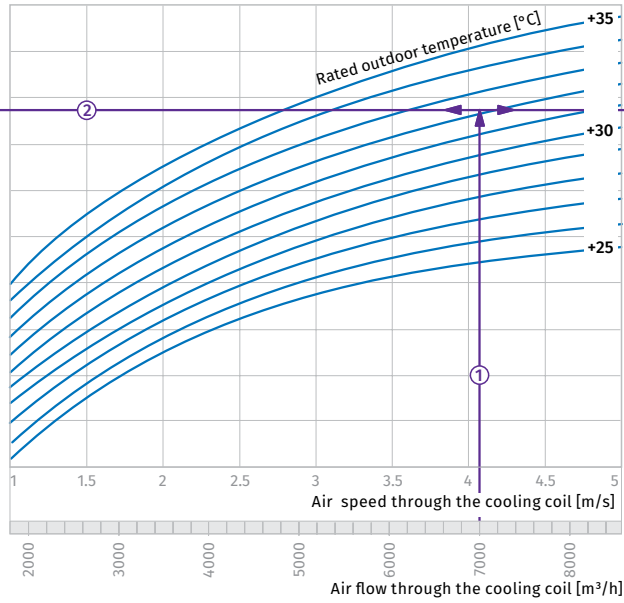
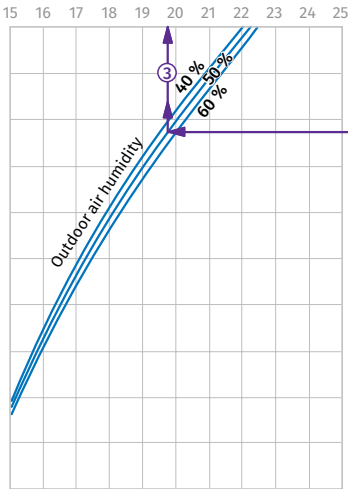

Coiling unit capacity [kW]

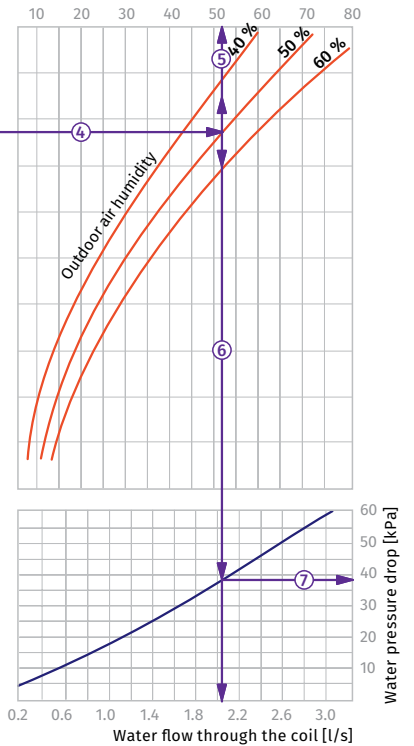

How to use water heater diagrams.

Sample parameters: Air flow = 7000 m³/h

The air flow is 7000 m³/h and the air speed in the cooling unit is 4.1 m/s ①.

- To calculate the coldest air temperature find the intersection point of the air flow line ① with the rated outer summer temperature shown in blue line (e.g., +32 °C) and draw the line ② to the left until it crosses the outdoor air humidity curve (e.g. 50 %). From this point draw a vertical line to the supply air temperature downstream of the cooling unit (+19.6 °C) ③.

- To calculate the power of the cooling unit find the intersection point of the air flow ① with the rated summer temperature (e.g., +32 °C) and draw the line ④ to the right until it crosses the air humidity curve (e.g., 50 %). From this point draw a vertical line to the cooling unit power axis (52 kW) ⑤.

- To calculate the required water flow in the cooling unit prolong this line ⑥ downwards to the water flow axis (2.05 l/s).
- To calculate the water pressure drop in the cooling unit find the intersection point of the line ⑥ with the pressure loss curve and prolong the line ⑦ to the right on the water pressure axis (37 kPa).

KFK

Duct DX cooling units for rectangular air ducts

Use

- Supply air cooling for ventilation systems in various premises.
- Suitable for installation into supply or air handling units to provide air cooling.



Design

- Galvanized steel casing.
- The cooling elements are made of copper tubes and aluminum plates.
- Available in three-coil modifications and rated for operation with R123, R134a, R152a, R404a, R407c, R410a, R507, R12, R22 refrigerants.
- Polypropylene droplet separator and drain pan for condensate drainage and removal included.
- Droplet separator operates efficiently at air flow below 4 m/s.

Mounting

- Only horizontal mounting by means of flanged connection. Condensate drainage must be provided.
- Air filter must be installed upstream of the cooling unit to prevent the unit soiling.
- Mounting position must ensure uniform air flow distribution through the entire cross section.
- Installation upstream or downstream of the supply fan. The minimum air duct length downstream of the fan must be 1–1.5 m to ensure air flow stabilization.
- The maximum cooling capacity is attained if the cooling unit is connected on counter-flow basis. The attached charts are valid for counter-flow connection.
- While mounting the cooling unit provide condensate drainage through the U-trap. The U-trap height must be selected with respect to the total fan pressure, refer to the table and diagram below.

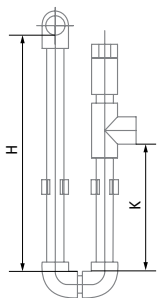

H [mm]	K [mm]	P [Pa]
100	55	600
200	105	1100
260	140	1400

H: U-trap height
K: drainage height
P: Total fan pressure

- For a proper and safe operation of the cooling unit it should be connected to a control system for integral control and automatic cooling capacity regulation.

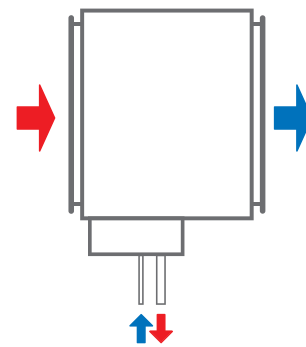

Counter air flow connection

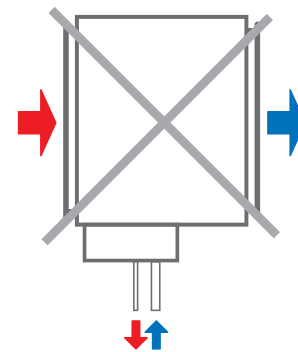

Air flow streamwise connection

Designation key

Series	Flange size (WxH) [cm]	Number of water (glycol) coil rows
KFK	40x20; 50x25; 50x30; 60x30; 60x35; 70x40; 80x50; 90x50; 100x50	- 3

Overall dimensions [mm]

Model	Ø D1	Ø D2	B	B1	B2	H	H1	H2	L
KFK 40x20-3	12	22	400	440	470	200	295	103	44
KFK 50x25-3	12	22	500	540	570	250	345	155	44
KFK 50x30-3	12	22	500	540	570	300	395	210	33
KFK 60x30-3	18	28	600	640	670	300	395	199	44
KFK 60x35-3	18	28	600	640	670	350	445	199	44
KFK 70x40-3	22	28	700	740	770	400	495	224	44
KFK 80x50-3	22	28	800	840	870	500	595	340	44
KFK 90x50-3	22	28	900	940	970	500	595	340	44
KFK 100x50-3	22	28	1000	1040	1070	500	595	325	44

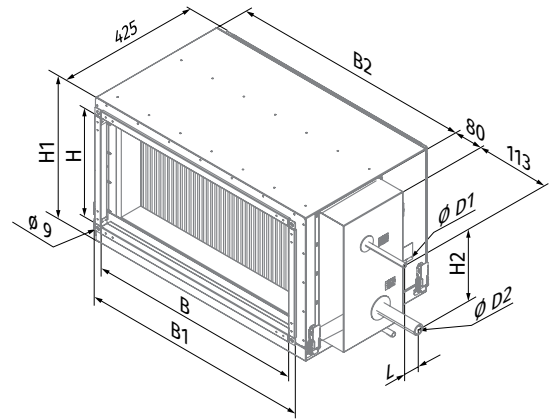

AIR PRESSURE LOSSES IN DX COOLING COILS

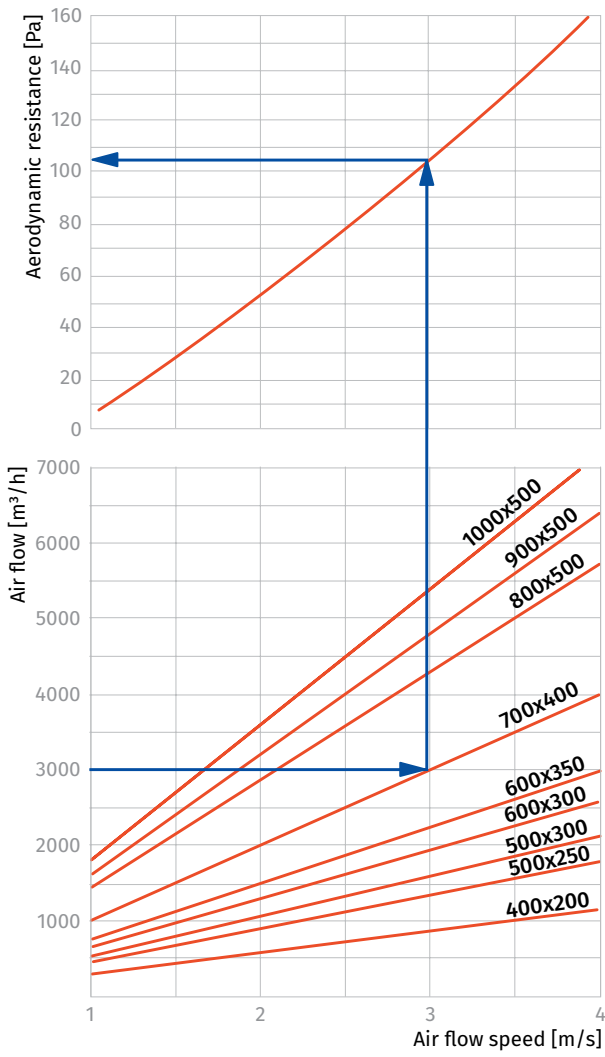

Water cooling unit calculation diagram

KFK 40x20-3

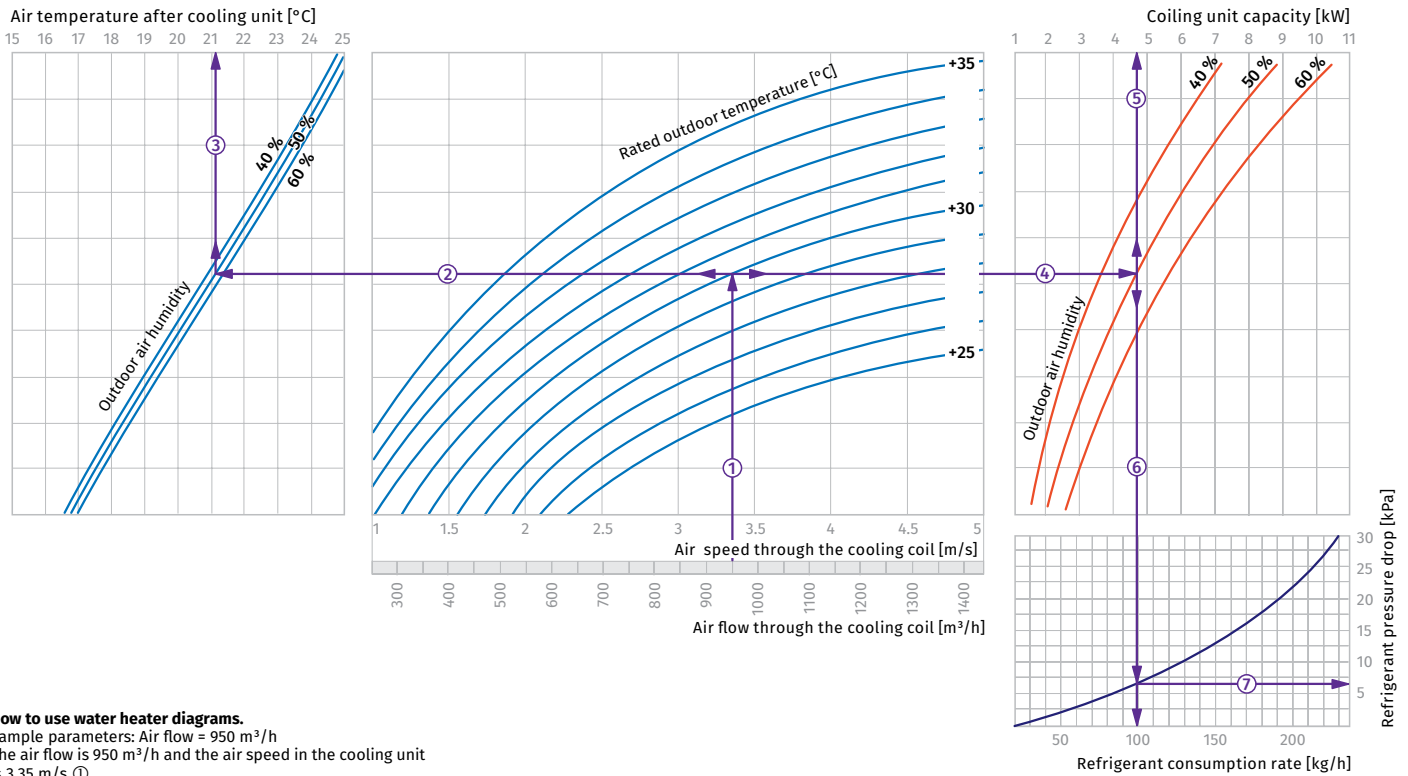

How to use water heater diagrams.

Sample parameters: Air flow = 950 m³/h
The air flow is 950 m³/h and the air speed in the cooling unit is 3.35 m/s ①.

- To calculate the coldest air temperature find the intersection point of the air flow line ① with the rated outdoor summer temperature shown in blue line (e.g., +30 °C) and draw the line ② to the left until it crosses the outdoor air humidity curve (e.g. 50 %). From this point draw a vertical line to the supply air temperature downstream of the cooling unit (+21.1 °C) ③.

- To calculate the power of the cooling unit find the intersection point of the air flow ① with the rated summer temperature (e.g., +30 °C) and draw the line ④ to the right until it crosses the air humidity curve (e.g., 50 %). From this point draw a vertical line to the cooling unit power axis (4.7 kW) ⑤.

- To calculate the required water flow in the cooling unit prolong this line ⑥ downwards to the water flow axis (100 kg/h).
- To calculate the water pressure drop in the cooling unit find the intersection point of the line ⑥ with the pressure loss curve and prolong the line ⑦ to the right on the water pressure axis (6.5 kPa).

KFK 50x25-3

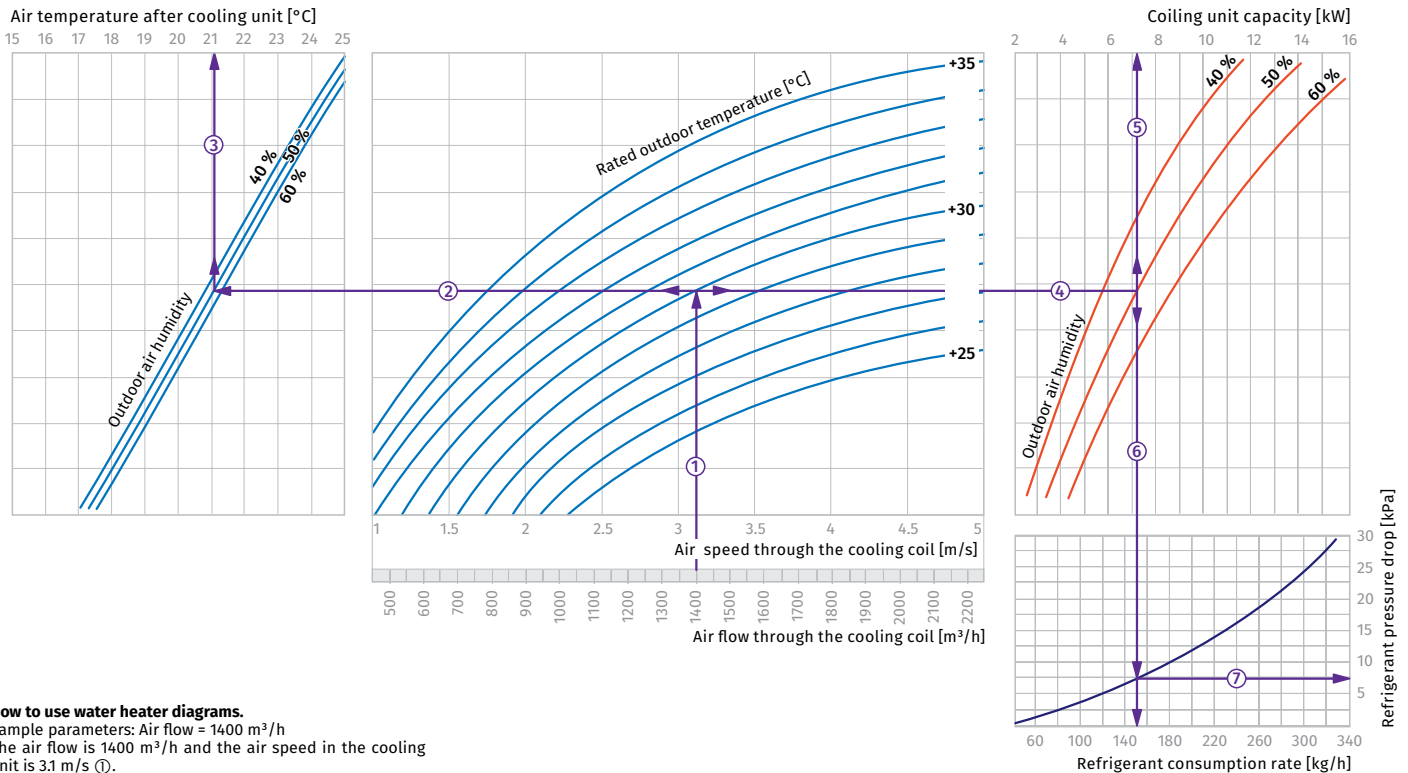

How to use water heater diagrams.

Sample parameters: Air flow = 1400 m³/h
The air flow is 1400 m³/h and the air speed in the cooling unit is 3.1 m/s ①.

- To calculate the coldest air temperature find the intersection point of the air flow line ① with the rated outdoor summer temperature shown in blue line (e.g., +30 °C) and draw the line ② to the left until it crosses the outdoor air humidity curve (e.g. 50 %). From this point draw a vertical line to the supply air temperature downstream of the cooling unit (+21.1 °C) ③.

- To calculate the power of the cooling unit find the intersection point of the air flow ① with the rated summer temperature (e.g., +30 °C) and draw the line ④ to the right until it crosses the air humidity curve (e.g., 50 %). From this point draw a vertical line to the cooling unit power axis (7.2 kW) ⑤.

- To calculate the required water flow in the cooling unit prolong this line ⑥ downwards to the water flow axis (152 kg/h).
- To calculate the water pressure drop in the cooling unit find the intersection point of the line ⑥ with the pressure loss curve and prolong the line ⑦ to the right on the water pressure axis (7.5 kPa).

KFK 50x30-3

Air temperature after cooling unit [°C]

15 16 17 18 19 20 21 22 23 24 25

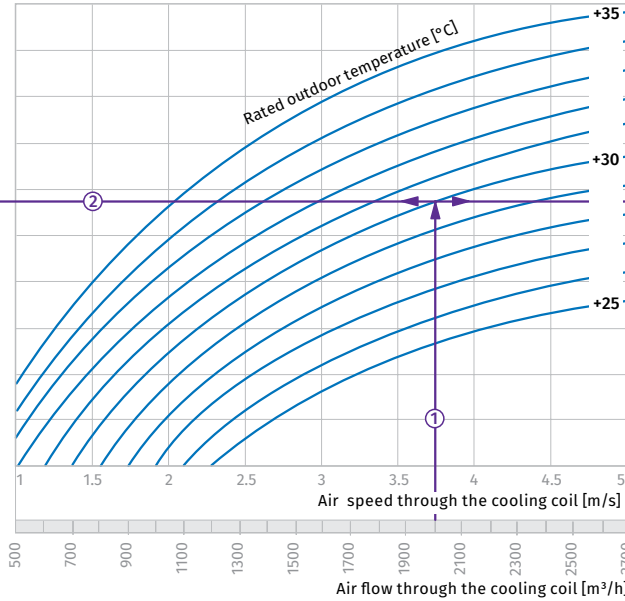
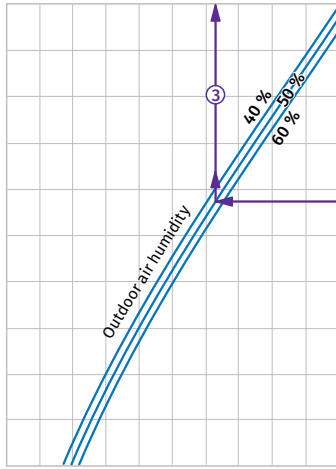

Coiling unit capacity [kW]

2 4 6 8 10 12 14 16 18 20 22

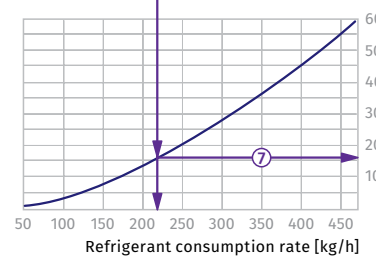

How to use water heater diagrams.

Sample parameters: Air flow = 2000 m³/h

The air flow is 2000 m³/h and the air speed in the cooling unit is 3.75 m/s ①.

- To calculate the coldest air temperature find the intersection point of the air flow line ① with the rated outer summer temperature shown in blue line (e.g., +30 °C) and draw the line ② to the left until it crosses the outdoor air humidity curve (e.g. 50 %). From this point draw a vertical line to the supply air temperature downstream of the cooling unit (+21.2 °C) ③.

- To calculate the power of the cooling unit find the intersection point of the air flow ① with the rated summer temperature (e.g., +30 °C) and draw the line ④ to the right until it crosses the air humidity curve (e.g. 50 %). From this point draw a vertical line to the cooling unit power axis (10 kW) ⑤.

- To calculate the required water flow in the cooling unit prolong this line ⑥ downwards to the water flow axis (215 kg/h).
- To calculate the water pressure drop in the cooling unit find the intersection point of the line ⑥ with the pressure loss curve and prolong the line ⑦ to the right on the water pressure axis (16.0 kPa).

KFK 60x30-3

Air temperature after cooling unit [°C]

15 16 17 18 19 20 21 22 23 24 25

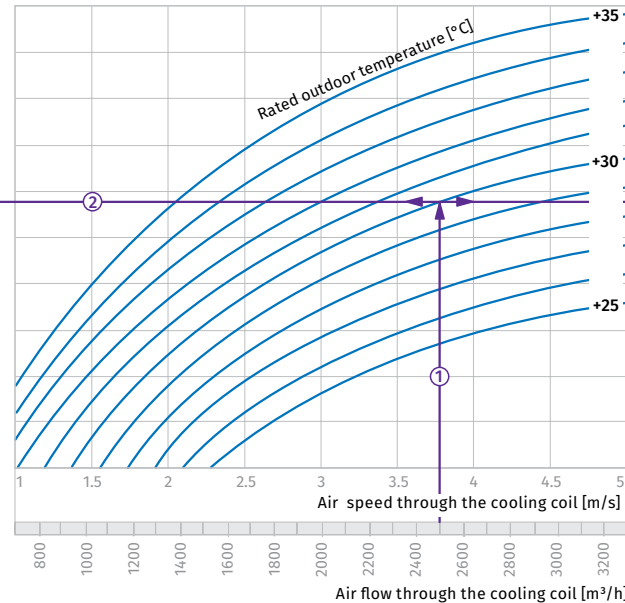
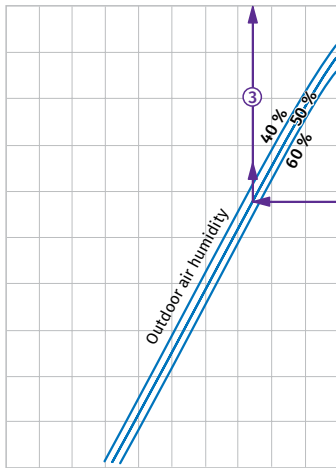

Coiling unit capacity [kW]

2 4 6 8 10 12 14 16 18 20 22

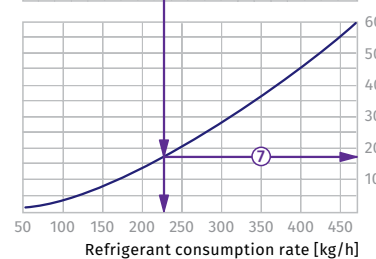
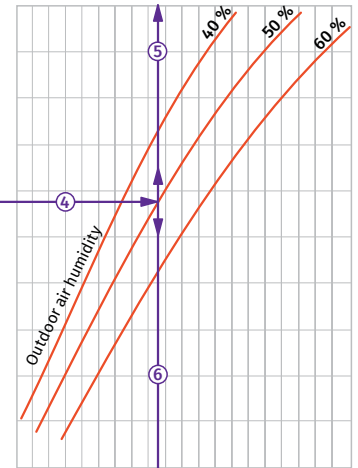

How to use water heater diagrams.

Sample parameters: Air flow = 2500 m³/h

The air flow is 2500 m³/h and the air speed in the cooling unit is 3.75 m/s ①.

- To calculate the coldest air temperature find the intersection point of the air flow line ① with the rated outer summer temperature shown in blue line (e.g., +30 °C) and draw the line ② to the left until it crosses the outdoor air humidity curve (e.g. 50 %). From this point draw a vertical line to the supply air temperature downstream of the cooling unit (+22.5 °C) ③.

- To calculate the power of the cooling unit find the intersection point of the air flow ① with the rated summer temperature (e.g., +30 °C) and draw the line ④ to the right until it crosses the air humidity curve (e.g. 50 %). From this point draw a vertical line to the cooling unit power axis (10.5 kW) ⑤.

- To calculate the required water flow in the cooling unit prolong this line ⑥ downwards to the water flow axis (225 kg/h).
- To calculate the water pressure drop in the cooling unit find the intersection point of the line ⑥ with the pressure loss curve and prolong the line ⑦ to the right on the water pressure axis (17.0 kPa).

KFK 60x35-3

Air temperature after cooling unit [°C]

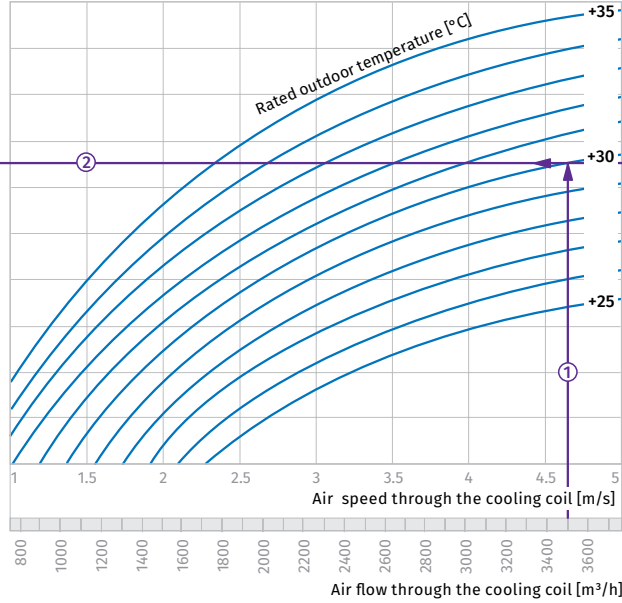
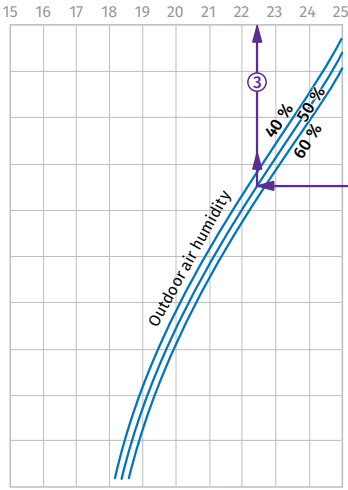

Coiling unit capacity [kW]

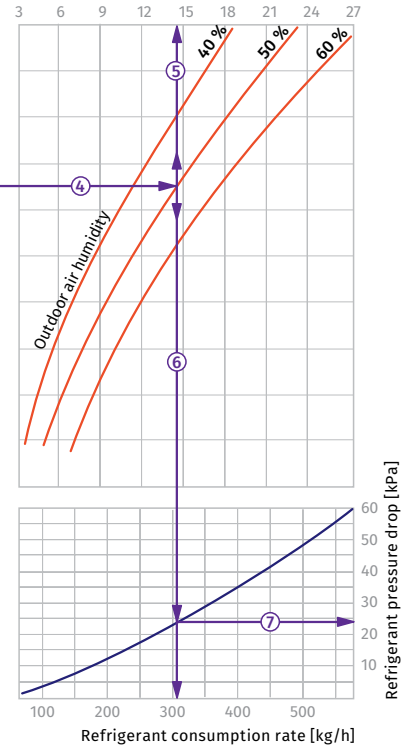

How to use water heater diagrams.

Sample parameters: Air flow = 3500 m³/h
The air flow is 3500 m³/h and the air speed in the cooling unit is 4.65 m/s ①.

- To calculate the coldest air temperature find the intersection point of the air flow line ① with the rated outer summer temperature shown in blue line (e.g., +30 °C) and draw the line ② to the left until it crosses the outdoor air humidity curve (e.g. 50 %). From this point draw a vertical line to the supply air temperature downstream of the cooling unit (+22.5 °C) ③.

- To calculate the power of the cooling unit find the intersection point of the air flow ① with the rated summer temperature (e.g., +30 °C) and draw the line ④ to the right until it crosses the air humidity curve (e.g., 50 %). From this point draw a vertical line to the cooling unit power axis (14.5 kW) ⑤.

- To calculate the required water flow in the cooling unit prolong this line ⑥ downwards to the water flow axis (310 kg/h).
- To calculate the water pressure drop in the cooling unit find the intersection point of the line ⑥ with the pressure loss curve and prolong the line ⑦ to the right on the water pressure axis (24.0 kPa).

COOLERS

KFK 70x40-3

Air temperature after cooling unit [°C]

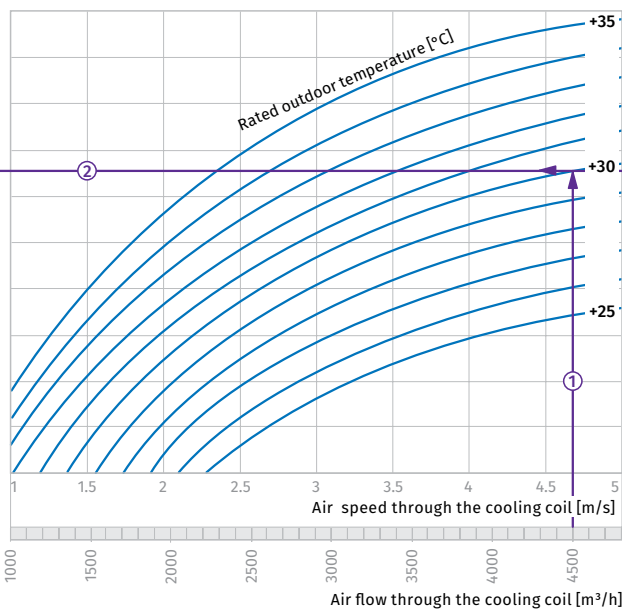
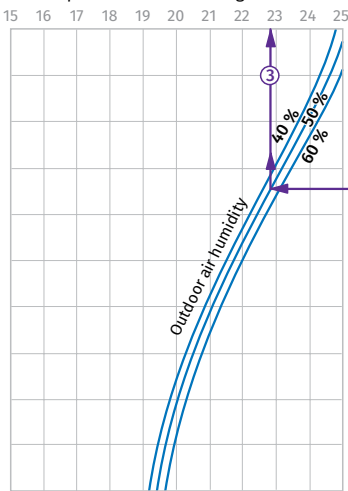

Coiling unit capacity [kW]

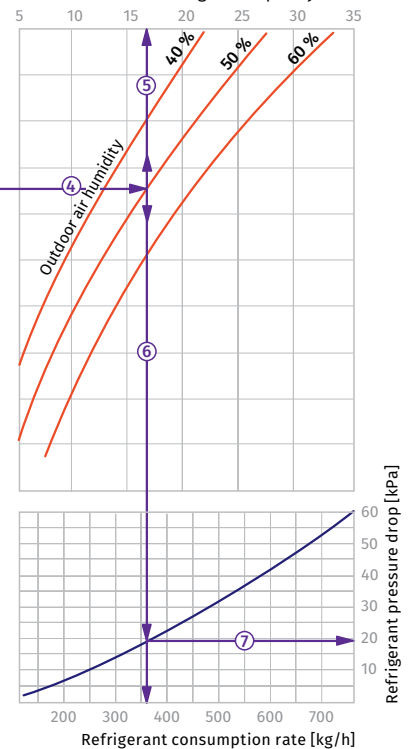

How to use water heater diagrams.

Sample parameters: Air flow = 4500 m³/h
The air flow is 4000 m³/h and the air speed in the cooling unit is 4.7 m/s ①.

- To calculate the coldest air temperature find the intersection point of the air flow line ① with the rated outer summer temperature shown in blue line (e.g., +30 °C) and draw the line ② to the left until it crosses the outdoor air humidity curve (e.g. 50 %). From this point draw a vertical line to the supply air temperature downstream of the cooling unit (+22.8 °C) ③.

- To calculate the power of the cooling unit find the intersection point of the air flow ① with the rated summer temperature (e.g., +30 °C) and draw the line ④ to the right until it crosses the air humidity curve (e.g., 50 %). From this point draw a vertical line to the cooling unit power axis (17 kW) ⑤.

- To calculate the required water flow in the cooling unit prolong this line ⑥ downwards to the water flow axis (360 kg/h).
- To calculate the water pressure drop in the cooling unit find the intersection point of the line ⑥ with the pressure loss curve and prolong the line ⑦ to the right on the water pressure axis (19.0 kPa).

KFK 80x50-3

Air temperature after cooling unit [°C]

15 16 17 18 19 20 21 22 23 24 25

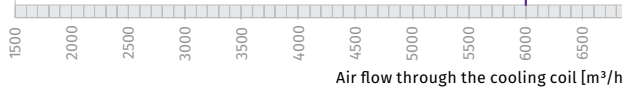
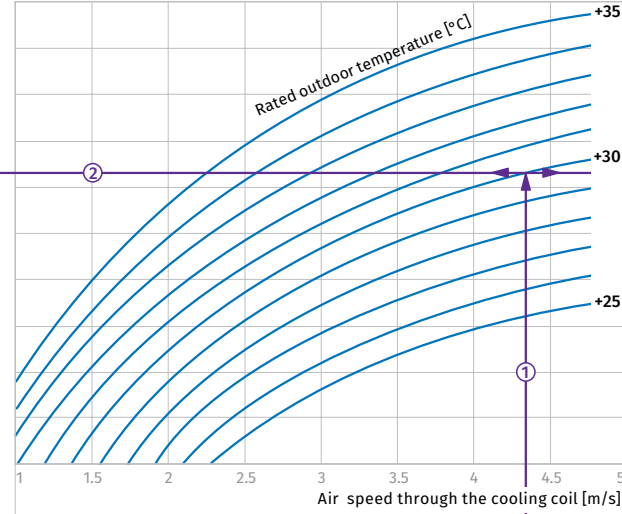
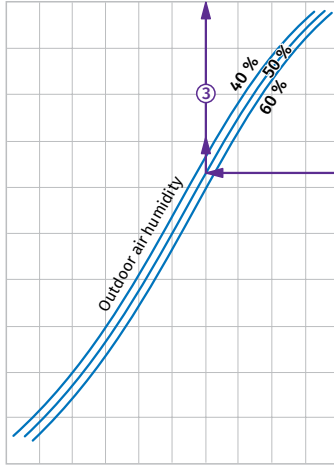

Coiling unit capacity [kW]

5 10 15 20 25 30 35 40 45

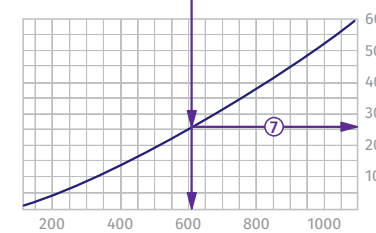
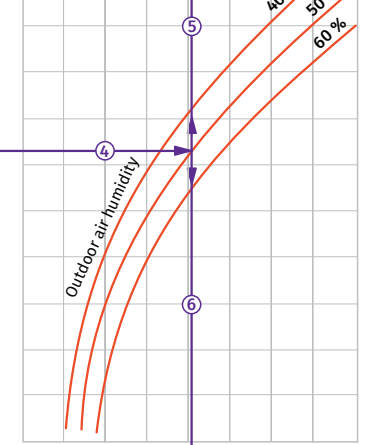

Refrigerant consumption rate [kg/h]

How to use water heater diagrams.

Sample parameters: Air flow = 6000 m³/h
The air flow is 6000 m³/h and the air speed in the cooling unit is 4.35 m/s ①.

- To calculate the coldest air temperature find the intersection point of the air flow line ① with the rated outer summer temperature shown in blue line (e.g., +30 °C) and draw the line ② to the left until it crosses the outdoor air humidity curve (e.g. 50 %). From this point draw a vertical line to the supply air temperature downstream of the cooling unit (+21 °C) ③.

- To calculate the power of the cooling unit find the intersection point of the air flow ① with the rated summer temperature (e.g., +30 °C) and draw the line ④ to the right until it crosses the air humidity curve (e.g., 50 %). From this point draw a vertical line to the cooling unit power axis (25.5 kW) ⑤.

- To calculate the required water flow in the cooling unit prolong this line ⑥ downwards to the water flow axis (605 kg/h).
- To calculate the water pressure drop in the cooling unit find the intersection point of the line ⑥ with the pressure loss curve and prolong the line ⑦ to the right on the water pressure axis (26.0 kPa).

KFK 90x50-3

Air temperature after cooling unit [°C]

15 16 17 18 19 20 21 22 23 24 25

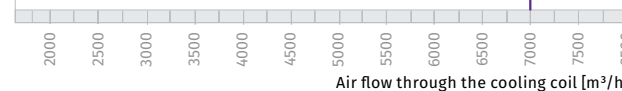
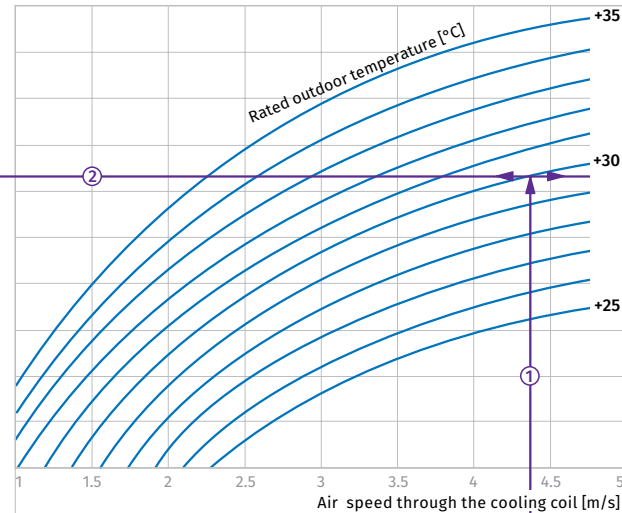
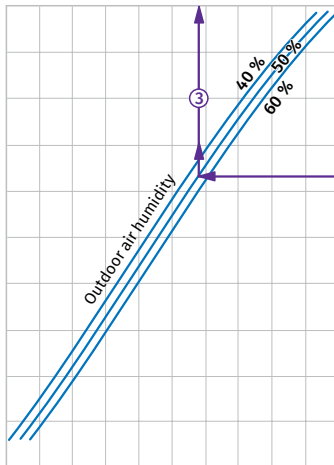

Coiling unit capacity [kW]

5 10 15 20 25 30 35 40 45 50 55

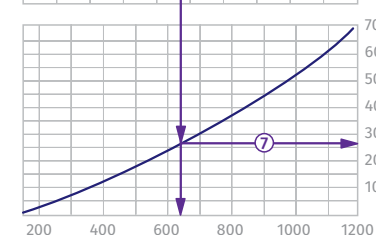
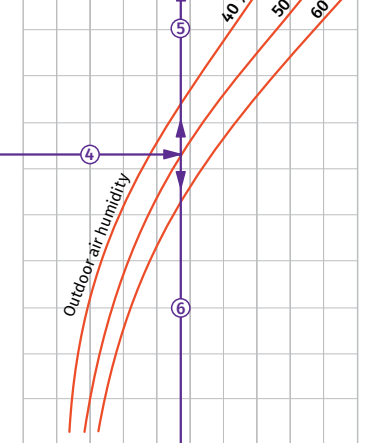

Refrigerant consumption rate [kg/h]

How to use water heater diagrams.

Sample parameters: Air flow = 7000 m³/h
The air flow is 7000 m³/h and the air speed in the cooling unit is 4.4 m/s ①.

- To calculate the coldest air temperature find the intersection point of the air flow line ① with the rated outer summer temperature shown in blue line (e.g., +30 °C) and draw the line ② to the left until it crosses the outdoor air humidity curve (e.g. 50 %). From this point draw a vertical line to the supply air temperature downstream of the cooling unit (+20.7 °C) ③.

- To calculate the power of the cooling unit find the intersection point of the air flow ① with the rated summer temperature (e.g., +30 °C) and draw the line ④ to the right until it crosses the air humidity curve (e.g., 50 %). From this point draw a vertical line to the cooling unit power axis (28 kW) ⑤.

- To calculate the required water flow in the cooling unit prolong this line ⑥ downwards to the water flow axis (640 kg/h).
- To calculate the water pressure drop in the cooling unit find the intersection point of the line ⑥ with the pressure loss curve and prolong the line ⑦ to the right on the water pressure axis (26.0 kPa).

KFK 100x50-3

Air temperature after cooling unit [°C]

15 16 17 18 19 20 21 22 23 24 25

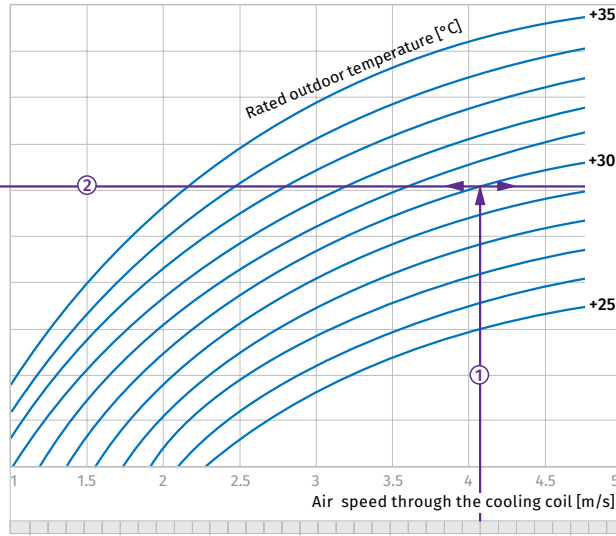
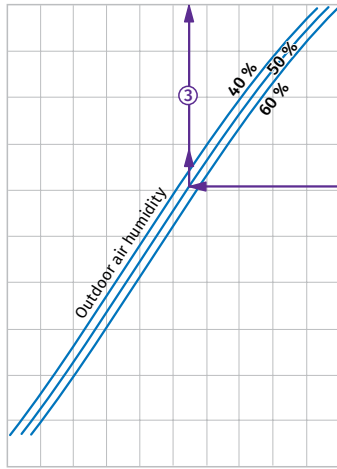

Air flow through the cooling coil [m³/h]

2000 3000 4000 5000 6000 7000 8000

Coiling unit capacity [kW]

5 10 15 20 25 30 35 40 45 50 55 60

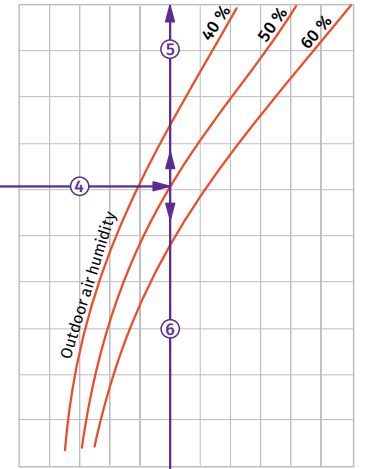

Refrigerant consumption rate [kg/h]

200 400 600 800 1000 1200 1400

Refrigerant pressure drop [kPa]

10 20 30 40 50 60 70

Refrigerant consumption rate [kg/h]

How to use water heater diagrams.

Sample parameters: Air flow = 7000 m³/h

The air flow is 7000 m³/h and the air speed in the cooling unit is 4.1 m/s ①.

- To calculate the coldest air temperature find the intersection point of the air flow line ① with the rated outer summer temperature shown in blue line (e.g., +30 °C) and draw the line ② to the left until it crosses the outdoor air humidity curve (e.g. 50 %). From this point draw a vertical line to the supply air temperature downstream of the cooling unit (+20.5 °C) ③.

- To calculate the power of the cooling unit find the intersection point of the air flow ① with the rated summer temperature (e.g., +30 °C) and draw the line ④ to the right until it crosses the air humidity curve (e.g., 50 %). From this point draw a vertical line to the cooling unit power axis (30.0 kW) ⑤.

- To calculate the required water flow in the cooling unit prolong this line ⑥ downwards to the water flow axis (710 kg/h).
- To calculate the water pressure drop in the cooling unit find the intersection point of the line ⑥ with the pressure loss curve and prolong the line ⑦ to the right on the water pressure axis (30.0 kPa).

TA

Droplet separators

Use

- The droplet separators are designed to remove condensed droplets from the air in the ventilation air ducts.
- Designed for direct installation in a rectangular air duct.



Design

- The droplet separator casing is made of galvanised steel, which eliminates corrosion during the whole period of operation.
- The drop separator profiles are made of special plastic, which delays the maximum possible number of droplets in the stream.
- The frames have an optimal profile to minimize the loss of airflow pressure.
- The droplet separator is equipped with a removable drain pan of stainless steel with anti-condensation insulation. The drain pan is equipped with a 16 mm drain pipe, which can be installed both from left and right.

Overall dimensions [mm]

Model	A	B	C	Weight [kg]
TA 400x200	503	293	163	4.5
TA 500x250	603	343	163	5.7
TA 500x300	603	393	163	6.2
TA 600x300	703	393	163	7.1
TA 600x350	703	443	163	7.7
TA 700x400	803	493	163	9.3
TA 800x500	903	593	163	11.7
TA 900x500	1003	593	163	13
TA 1000x500	1103	593	163	14.2

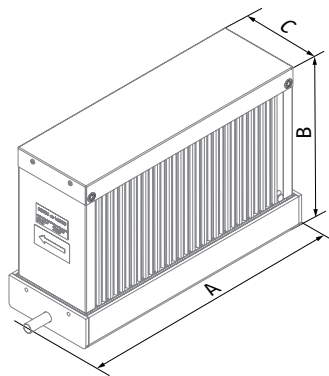

Mounting

- The droplet separator design ensures its mounting by means of flange connection.
- The air flow direction shall match the pointer on the droplet separator. Installation is carried out horizontally, with the condensate drain pan down.
- The droplet separators are installed in the air duct system downstream of the coolers and heat exchangers.

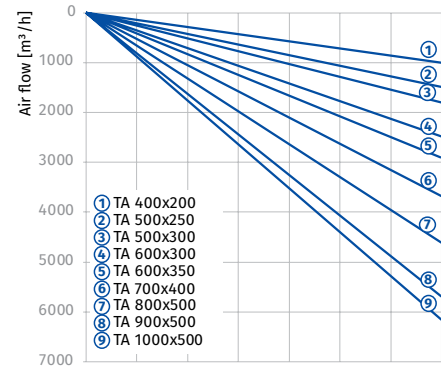
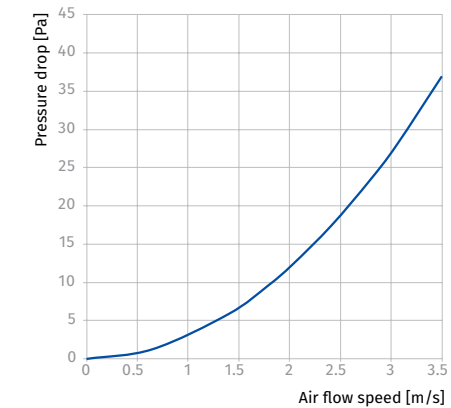

Designation key

Series	Flange dimensions (width x height) [mm]
TA	400x200; 500x250; 500x300; 600x300; 600x350; 700x400; 800x500; 900x500; 1000x500

SD

Silencers for round ducts

Use

- For attenuation of noise produced by a ventilation system and spreaded along ventilation ductworks.
- Used jointly with sound-insulated fans in premises with high requirements to noise level produced by ventilation equipment.
- Compatible with Ø 100 mm up to 315 mm round air ducts.



Design

- Galvanized steel case is filled with non-flammable sound-absorbing material with protecting covering against fiber blowing.
- Airtight connection with air ducts due to connecting flanges with rubber seals.
- A great variety of standard ranges with several length options.

Mounting

- Fixing to round ducts with clamps.
- Any mounting position.
- For better sound absorption install the silencers in series.

Designation key

Series	Connected air duct diameter [mm]	Length [mm]
SD	100; 125; 150; 160; 200; 250; 315	600; 900; 1200

Overall dimensions [mm]

Model	Ø D	Ø D1	L	L1	Weight [kg]
SD 100/600	99	200	600	50	2.2
SD 100/900	99	200	900	50	3.2
SD 100/1200	99	200	1200	50	4.3
SD 125/600	124	225	600	50	2.7
SD 125/900	124	225	900	50	4.1
SD 125/1200	124	225	1200	50	5.4
SD 150/600	149	250	600	50	2.8
SD 150/900	149	250	900	50	4.2
SD 150/1200	149	250	1200	50	5.6
SD 160/600	159	260	600	50	3.1
SD 160/900	159	260	900	50	4.6
SD 160/1200	159	260	1200	50	6.2
SD 200/600	199	300	600	50	3.5
SD 200/900	199	300	900	50	5.3
SD 200/1200	199	300	1200	50	7.1
SD 250/600	249	350	600	50	4.2
SD 250/900	249	350	900	50	6.2
SD 250/1200	249	350	1200	50	8.3
SD 315/600	314	415	600	50	4.7
SD 315/900	314	415	900	50	7.1
SD 315/1200	314	415	1200	50	9.4

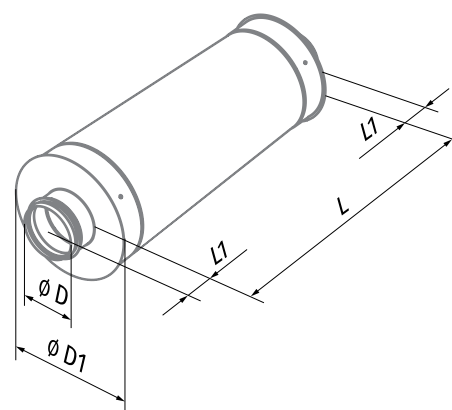

Noise level reduction, dB (octave-frequency band [Hz])

Model	63 Hz	125 Hz	250 Hz	500 Hz	1000 Hz	2000 Hz	4000 Hz	8000 Hz
SD 100/600	4	8	10	20	34	30	13	14
SD 100/900	5	10	15	23	44	30	16	15
SD 100/1200	6	11	19	28	50	34	20	18
SD 125/600	3	5	6	15	28	17	10	9
SD 125/900	4	9	12	22	43	22	16	12
SD 125/1200	4	9	16	27	48	27	21	17
SD 150/600	2	4	8	16	32	11	7	7
SD 150/900	3	5	9	18	36	25	13	14
SD 150/1200	4	8	14	25	43	30	18	19
SD 160/600	2	4	8	17	33	11	7	7
SD 160/900	2	5	10	19	37	25	13	15
SD 160/1200	4	10	14	24	42	30	19	20
SD 200/600	2	4	6	10	27	13	7	7
SD 200/900	3	7	11	20	39	23	8	7
SD 200/1200	4	10	14	23	40	26	13	12
SD 250/600	4	5	6	11	22	12	7	6
SD 250/900	4	5	7	16	32	20	12	10
SD 250/1200	4	6	8	17	34	22	14	12
SD 315/600	2	4	5	10	17	9	6	5
SD 315/900	3	5	8	17	30	14	10	8
SD 315/1200	4	7	11	22	36	18	14	10

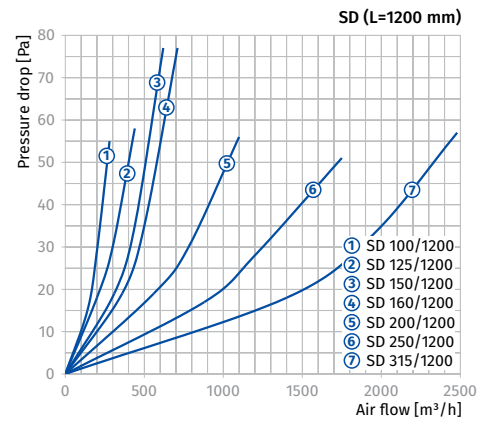
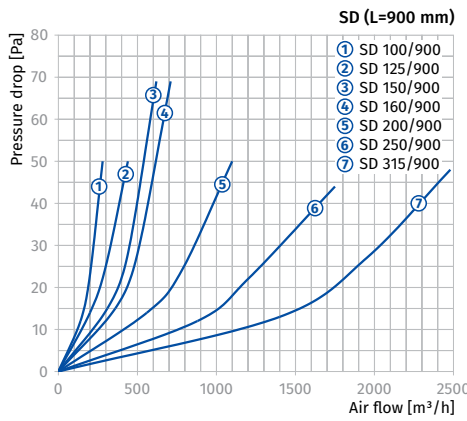
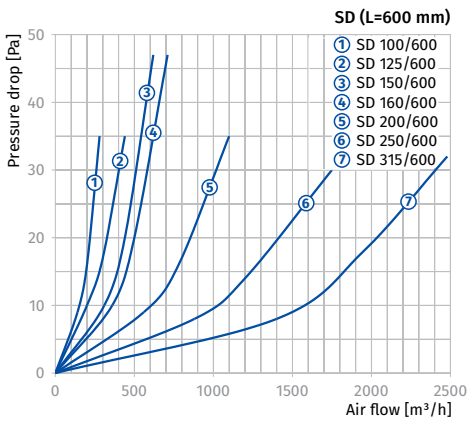

SDF

Flexible silencers for round ducts

Use

- For attenuation of noise produced by a ventilation system and spreaded along ventilation ductworks.
- Used jointly with sound-insulated fans in premises with high requirements to noise level produced by ventilation equipment.
- Compatible with \varnothing 100 mm up to 315 mm round air ducts.



Design

- Consists of outer and inner flexible spiral seam air ducts made of aluminium alloy and filled with non-flammable sound-absorbing material.
- Internal surface is perforated and covered with protection coating to prevent fiber blowing-out.
- A great variety of standard ranges with several length options.

Mounting

- Fixing to round ducts with clamps.
- Any mounting position.
- For better sound absorption install the silencers in series.
- Fixing on both ends and in the middle to prevent sagging.

Designation key

Series	Connected air duct diameter [mm]	Length [mm]
SDF	100; 125; 150; 160; 200; 250; 315	/ 600; 900; 1200

Overall dimensions [mm]

Model	\varnothing D	\varnothing D1	L	L1	Weight [kg]
SDF 100/600	99	220	600	55	1.6
SDF 100/900	99	220	900	55	2.4
SDF 100/2000	99	220	2000	55	5.2
SDF 125/600	124	270	600	55	2.0
SDF 125/900	124	270	900	55	3.0
SDF 125/2000	124	270	2000	55	6.6
SDF 150/600	149	270	600	55	2.1
SDF 150/900	149	270	900	55	3.1
SDF 150/2000	149	270	2000	55	6.8
SDF 160/600	159	270	600	55	2.1
SDF 160/900	159	270	900	55	3.2
SDF 160/2000	159	270	2000	55	7.0
SDF 200/600	199	320	600	55	2.6
SDF 200/900	199	320	900	55	3.9
SDF 200/2000	199	320	2000	55	8.6
SDF 250/600	249	370	600	55	3.0
SDF 250/900	249	370	900	55	4.5
SDF 250/2000	249	370	2000	55	10.1
SDF 315/600	314	420	600	55	3.4
SDF 315/900	314	420	900	55	5.1
SDF 315/2000	314	420	2000	55	11.4

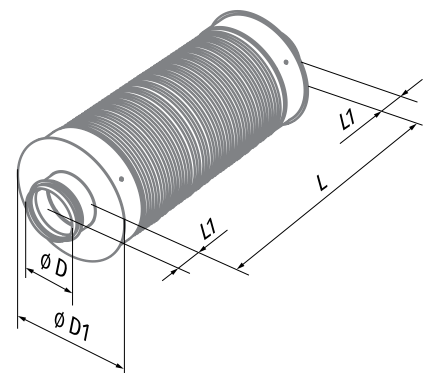

Noise level reduction, dB (octave-frequency band [Hz])

Model	63 Hz	125 Hz	250 Hz	500 Hz	1000 Hz	2000 Hz	4000 Hz	8000 Hz
SDF 100/600	6	8	13	22	28	34	17	20
SDF 100/900	8	10	15	25	33	40	21	23
SDF 100/2000	10	15	24	48	53	51	39	36
SDF 125/600	4	7	14	20	31	31	13	12
SDF 125/900	5	9	16	23	36	37	17	16
SDF 125/2000	7	15	23	47	55	50	28	25
SDF 150/600	3	7	12	32	40	40	19	20
SDF 150/900	4	8	14	40	48	49	26	25
SDF 150/2000	5	10	21	42	50	48	26	25
SDF 160/600	3	7	12	20	25	24	10	12
SDF 160/900	3	8	13	21	28	28	13	16
SDF 160/2000	5	11	20	40	48	48	25	25
SDF 200/600	2	5	12	20	26	21	10	10
SDF 200/900	3	6	12	22	28	24	12	13
SDF 200/2000	4	11	22	42	51	34	19	23
SDF 250/600	2	3	8	16	22	13	10	10
SDF 250/900	2	4	9	18	25	16	11	12
SDF 250/2000	3	6	16	30	39	27	17	22
SDF 315/600	2	4	9	18	21	12	7	9
SDF 315/900	2	5	11	21	24	14	8	10
SDF 315/2000	4	7	17	34	39	24	14	18

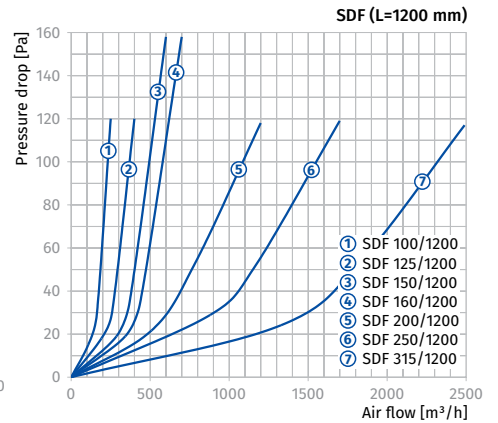
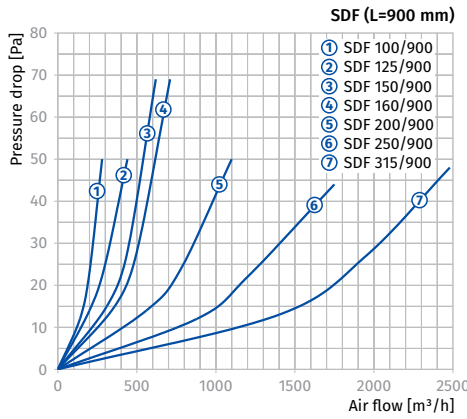
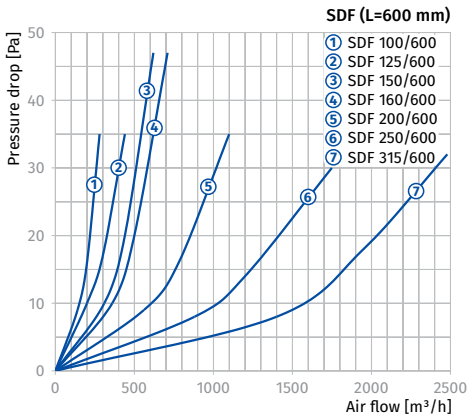

SILENCERS

SD

Silencers for rectangular ducts

Use

- For attenuation of the noise produced by a ventilation system and spreaded along ventilation ductworks.
- Used jointly with sound-insulated fans in premises with high requirements to noise level produced by ventilation equipment.
- Compatible with 400x200 up to 1000x500 mm rectangular air ducts.



Design

- Galvanized steel case and sleeves.
- The plates are filled with non-flammable sound-absorption material with protecting coating to prevent fiber blowing.

Mounting

- Fixing to rectangular ducts with flange connection.
- For maximum sound absorption capacity provide a straight air duct section at least 1 m long towards the silencer.
- For better sound absorption install the silencers in series.

Designation key

Series	Flange size (WxH) [cm]
SD	40x20; 50x25; 50x30; 60x30; 60x35; 70x40; 80x50; 90x50; 100x50

Overall dimensions [mm]

Model	B	B1	B2	H	H1	H2	L	Weight [kg]
SD 40x20	400	420	440	200	220	240	950	18.5
SD 50x25	500	520	540	250	270	290	950	20.5
SD 50x30	500	520	540	300	320	340	950	24.5
SD 60x30	600	620	640	300	320	340	950	26.5
SD 60x35	600	620	640	350	370	390	950	28.7
SD 70x40	700	720	740	400	420	440	1010	36.7
SD 80x50	800	820	840	500	520	540	1010	50.0
SD 90x50	900	920	940	500	520	540	1010	51.7
SD 100x50	1000	1020	1040	500	520	540	1010	57.3

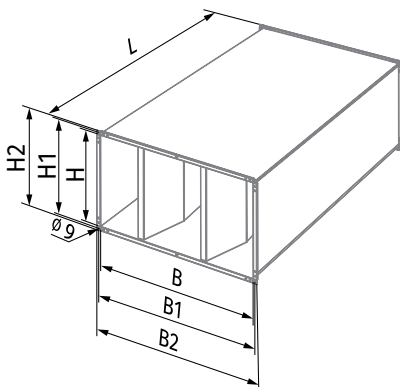

Noise level reduction, dB (octave-frequency band [Hz])

Model	63 Hz	125 Hz	250 Hz	500 Hz	1000 Hz	2000 Hz	4000 Hz	8000 Hz
SD 40x20	3	7	10	23	27	30	25	22
SD 50x25	3	6	11	22	26	25	27	22
SD 50x30	3	6	10	23	24	25	23	18
SD 60x30	3	6	10	21	24	30	24	17
SD 60x35	3	5	11	22	25	29	24	21
SD 70x40	4	7	10	15	22	19	21	18
SD 80x50	5	6	11	17	21	20	22	20
SD 90x50	3	6	10	16	20	20	21	15
SD 100x50	4	6	11	16	21	21	23	17

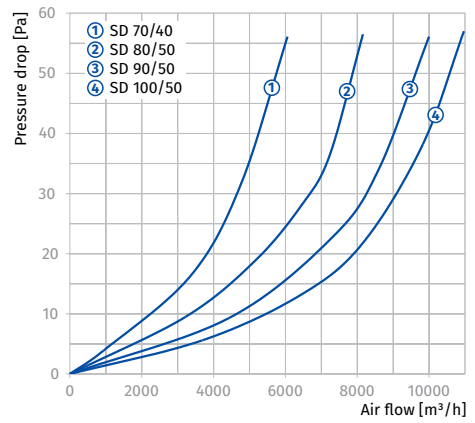
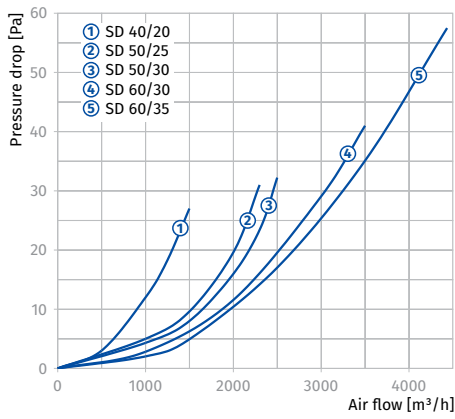

VK

Air dampers for round ducts

Use

- For manual regulation of air flow volume in the air ducts.
- Compatible with Ø 80 to 450 mm round air ducts.



Design

- The casing and the rotary blade are made of galvanized steel.
- Airtight connection to air ducts due to rubber seals.
- Air flow manual regulation with a metal handle equipped with a lever and a locking device for fixing the position of the rotary blades.

Mounting

- Fixing to round ducts with clamps.

Designation key

Series	Connected air duct diameter [mm]
VK	80; 100; 125; 150; 160; 200; 250; 315; 355; 400; 450

Overall dimensions [mm]

Model	Ø D	B	L	Weight [kg]
VK 80	79	140	200	0.57
VK 100	99	170	200	0.68
VK 125	124	195	200	0.82
VK 150	149	220	200	0.95
VK 160	159	230	200	1.01
VK 200	199	270	200	1.29
VK 250	249	320	200	1.64
VK 315	314	385	240	2.51
VK 355	348	425	240	2.84
VK 400	399	470	240	3.38
VK 450	449	520	240	3.94

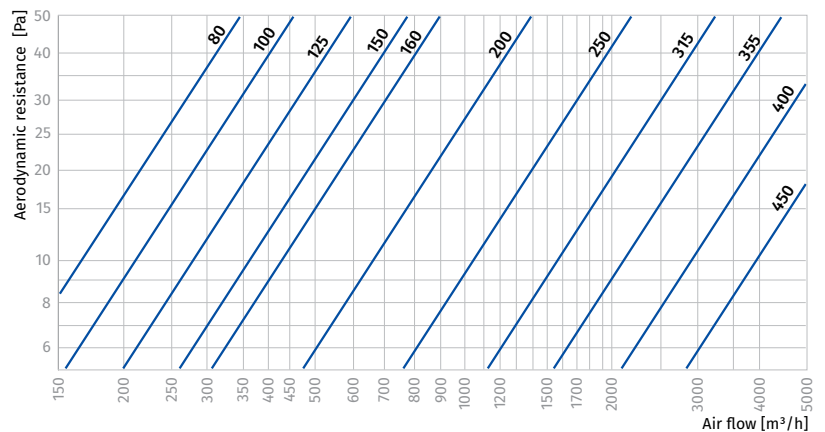
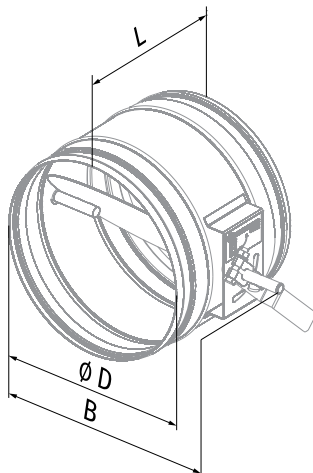

VKA

Air dampers for round ducts

Use

- For automatic shutoff of air ducts installed in ventilation systems of various premises.
- Compatible with Ø 80 to 450 mm round air ducts.



Design

- The casing and the rotary blade are made of galvanized steel.
- Airtight connection to air ducts due to rubber seals.
- A shaft and a mounting pad are provided for **BELIMO** electric actuator. Compatible actuators are shown in the table below.

Designation key

Series	Connected air duct diameter [mm]
VKA	80; 100; 125; 150; 160; 200; 250; 315; 355; 400; 450

Overall dimensions [mm]

Model	Ø D	B	L	H	Weight [kg]
VKA 80	79	190	200	170	0.6
VKA 100	99	220	200	180	0.72
VKA 125	124	245	200	195	0.86
VKA 150	149	270	200	205	1.01
VKA 160	159	280	200	210	1.07
VKA 200	199	320	200	230	1.33
VKA 250	249	370	200	255	1.68
VKA 315	314	435	240	-	2.44
VKA 355	348	475	240	-	2.75
VKA 400	399	520	240	-	3.26
VKA 450	449	570	240	-	3.78

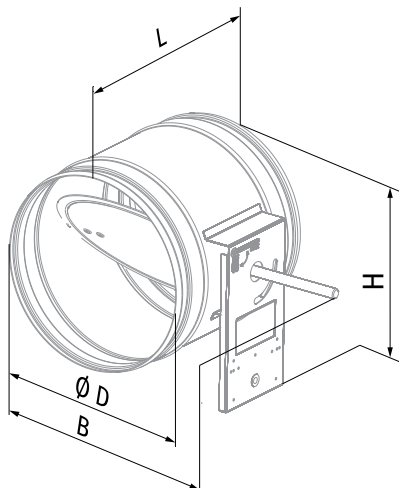

Mounting

- Fixing to round ducts with clamps.
- While mounting provide enough space for accessing the electric actuator.

Compatibility table

Compatibility table for shutters with an electrical actuator

Model	Actuator type			
	Electric actuator, 230 V	Electric actuator with spring return, 230 V	Electric actuator, 24 V	Electric actuator with spring return, 24 V
VKA 80	CM230 / LM230A	TF230	CM24 / LM24A	TF24
VKA 100	CM230 / LM230A	TF230	CM24 / LM24A	TF24
VKA 125	CM230 / LM230A	TF230	CM24 / LM24A	TF24
VKA 150	CM230 / LM230A	TF230	CM24 / LM24A	TF24
VKA 160	CM230 / LM230A	TF230	CM24 / LM24A	TF24
VKA 200	CM230 / LM230A	TF230	CM24 / LM24A	TF24
VKA 250	CM230 / LM230A	TF230	CM24 / LM24A	TF24
VKA 315	CM230 / LM230A	TF230	CM24 / LM24A	TF24
VKA 355	CM230 / LM230A	TF230	CM24 / LM24A	TF24
VKA 400	CM230 / LM230A	TF230	CM24 / LM24A	TF24
VKA 450	CM230 / LM230A	TF230	CM24 / LM24A	TF24

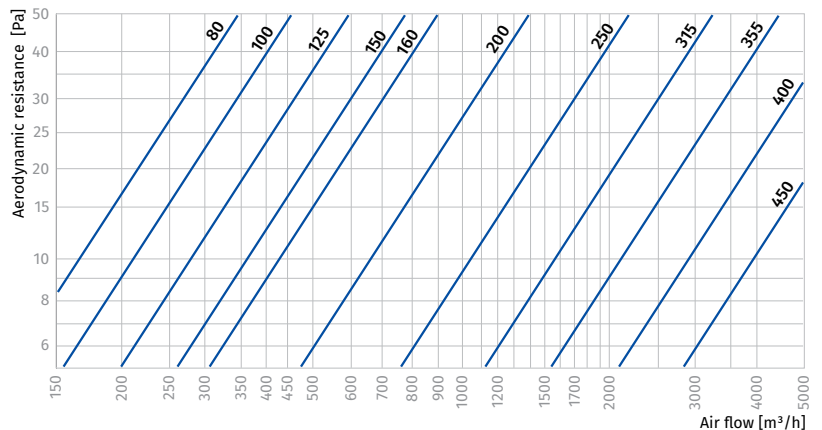

VK

Air dampers for rectangular ducts

Use

- For manual regulation of air flow or shut-off of air ducts.
- Compatible with 400x200 up to 600x350 mm rectangular air ducts.



Design

- Galvanized steel case and rotary blade.
- Manual regulation with a metal handle equipped with a lever and a locking device for fixing the position of the rotary blade.

Designation key

Series	Flange size [cm]
VK	20x40; 50x25; 50x30; 60x30; 60x35

Overall dimensions [mm]

Model	B	B1	B2	H	H1	L	Weight [kg]
VK 40x20	400	440	460	200	240	202	3.0
VK 50x25	500	540	560	250	290	202	3.8
VK 50x30	500	540	560	300	340	202	3.1
VK 60x30	600	640	660	300	340	202	4.2
VK 60x35	600	640	660	350	390	202	5.1

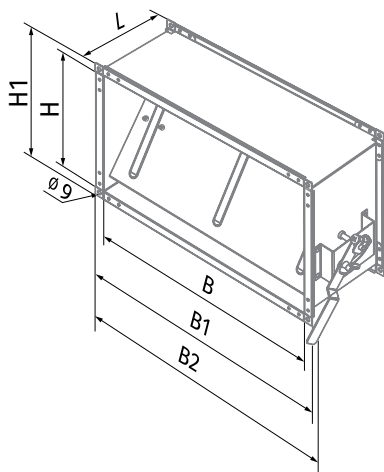

Mounting

- Fixing to rectangular ducts with flange connection.
- Mounting with galvanized bolts and clamps that fix the end flanges of the air shutter to the mating flanges of the air ducts or any other ventilation system components.

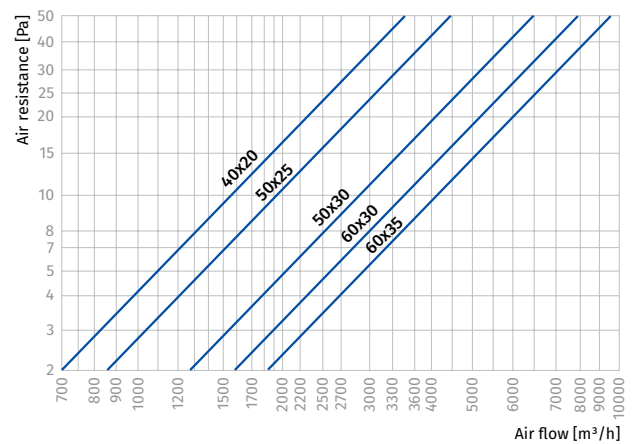

SL

Air dampers for rectangular ducts

Use

- For manual regulation of air flow volume or shut-off of air ducts installed in ventilation systems of various premises.
- Compatible with 400x200 mm up to 1000x500 mm rectangular air ducts.



Design

- The multi-blade design with the counter-rotated blades.
- The casing is made of galvanized steel.
- The rotary blades from aluminium profile are rotated with the gears.
- Air flow manual regulation with a metal handle equipped with a lever and a locking device to fix position of the rotary blades.
- A shaft and a mounting pad are provided for **BELIMO** electric actuator. Compatible actuators are shown in the table below.

Mounting

- Fixing to rectangular ducts with flange connection.
- Mounting with galvanized bolts and clamps that fix the end flanges of the air flow regulators to the mating flanges of the air ducts or any other ventilation system components.

Compatibility table of air dampers with electric actuators

Model	Actuator type			
	Electric actuator, 230 V	Electric actuator with spring return, 230 V	Electric actuator, 24 V	Electric actuator with spring return, 24 V
SL 40x20	CM230 / LM230A	TF230 / LF230	CM24 / LM24A	TF24 / LF24
SL 50x25	CM230 / LM230A	TF230 / LF230	CM24 / LM24A	TF24 / LF24
SL 50x30	CM230 / LM230A	TF230 / LF230	CM24 / LM24A	TF24 / LF24
SL 60x30	CM230 / LM230A	TF230 / LF230	CM24 / LM24A	TF24 / LF24
SL 60x35	CM230 / LM230A	TF230 / LF230	CM24 / LM24A	TF24 / LF24
SL 70x40	LM230A	LF230	LM24A	LF24
SL 80x50	LM230A	LF230	LM24A	LF24
SL 90x50	LM230A	LF230	LM24A	LF24
SL 100x50	LM230A	LF230	LM24A	LF24

Designation key	
Series	Flange size [cm]
SL	40x20; 50x25; 50x30; 60x30; 60x35; 70x40; 80x50; 90x50; 100x50

Overall dimensions [mm]

Model	B	B1	B2	H	H1	L	Weight [kg]
SL 40x20	400	440	540	200	240	170	3.5
SL 50x25	500	540	640	250	290	170	4.2
SL 50x30	500	540	640	300	340	170	4.9
SL 60x30	600	640	740	300	340	170	5.4
SL 60x35	600	640	740	350	390	170	5.7
SL 70x40	700	740	840	400	440	170	7.7
SL 80x50	800	840	940	500	540	170	8.8
SL 90x50	900	940	1040	500	540	170	9.6
SL 100x50	1000	1040	1140	500	540	170	10.3

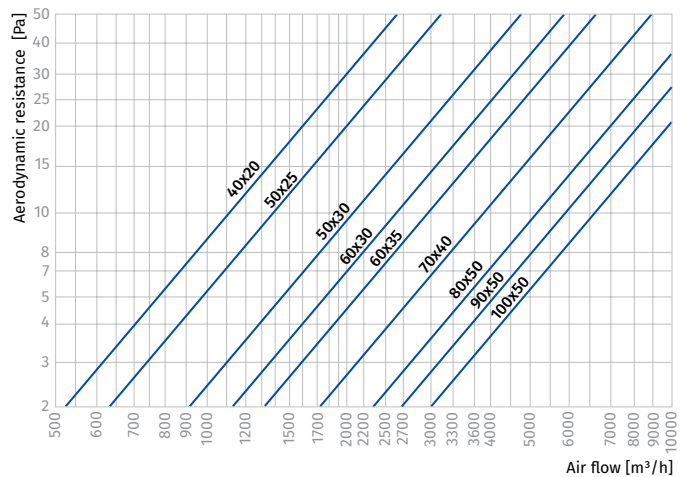
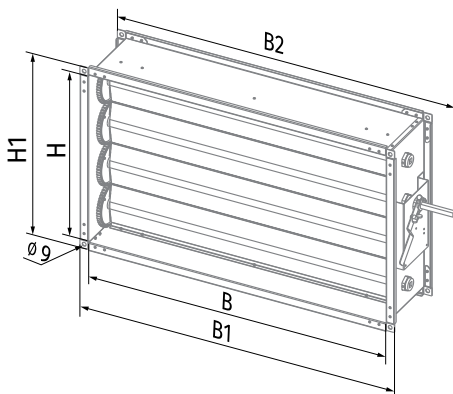

VRV

Backdraft dampers with spring for round ducts

Use

- For automatic shutoff of the air ducts and prevention of back drafting when the fan is off. Suitable for installation in various premises.
- Compatible with Ø 100 up to 315 mm round air ducts.



Design

- Galvanized steel case.
- Two spring-loaded blades made of aluminium.
- Blades are opened by air pressure and are closed with a spring.

Mounting

- Fixing to round ducts with clamps.
- Provide vertical position of blade axis.
- Install the backdraft damper into the ventilation system with respect to the air flow direction.

Designation key

Series	Connected air duct diameter [mm]
VRV	100; 125; 150; 160; 200; 250; 315

Overall dimensions [mm]

Model	Ø D	L	Weight [kg]
VRV 100	99	80	0.18
VRV 125	124	100	0.27
VRV 150	149	115	0.38
VRV 160	159	120	0.42
VRV 200	199	145	0.63
VRV 250	249	165	0.90
VRV 315	314	190	1.31

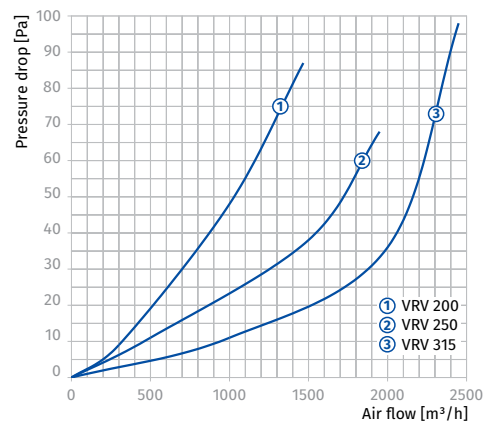
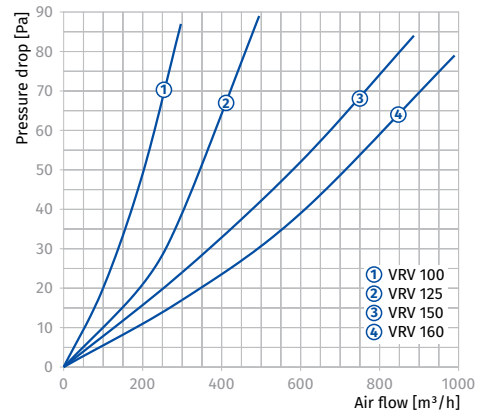
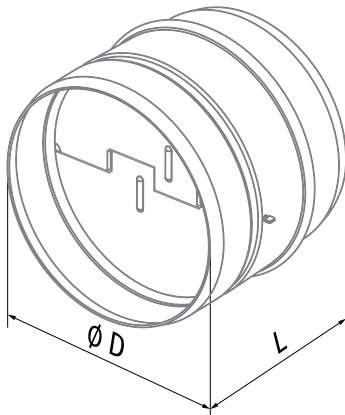

VRVS

Backdraft air dampers for round ducts



Use

- For automatic shut-off of the air ducts and prevention of back drafting when the fan off. Suitable for installation in various premises.
- Compatible with \varnothing 100 up to 315 mm round air ducts.

Design

- Galvanized steel case and rotary gravity-actuated blade.
- Airtight connection with the air ducts due to rubber seals.
- The damper blade is opened with air pressure and reset automatically when the fan is off and no air pressure is produced.
- Manual handle with a counterweight to regulate the damper opening-closing sensitivity.

Designation key	
Series	Connected air duct diameter [mm]
VRVS	100; 125; 150; 160; 200; 250; 315

Overall dimensions [mm]

Model	\varnothing D	B	L	Weight [kg]
VRVS 100	99	139	150	0.65
VRVS 125	124	162	170	0.81
VRVS 150	149	194	180	0.97
VRVS 160	159	204	190	1.06
VRVS 200	199	238	220	1.57
VRVS 250	249	290	270	2.2
VRVS 315	314	356	340	3.24

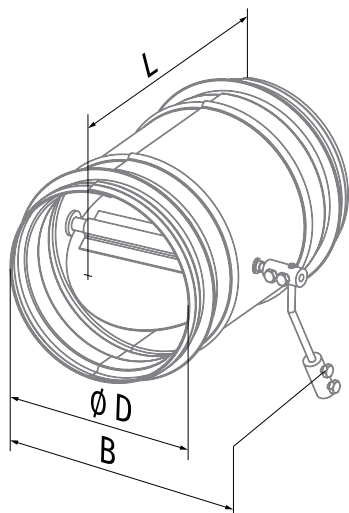

Mounting

- Fixing to round ducts with clamps.
- Provide free gravity actuated movement of the blade.
- Install the backdraft damper into the ventilation system with respect to the air flow direction.

VRVS

Backdraft air dampers for rectangular ducts

Use

- For automatic shut-off of the air ducts and prevention of back drafting when the fan is off. Suitable for installation in various premises.
- Compatible with 400x200 up to 600x350 mm rectangular air ducts.

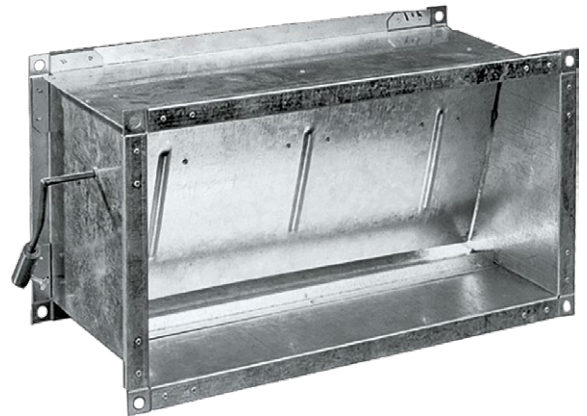

Design

- Galvanized steel case and rotary gravity-actuated blade.
- The damper blade is opened with air pressure and reset automatically when the fan is off and no air pressure is produced.
- Manual handle with a counterweight to regulate the damper opening-closing sensitivity.

Mounting

- Fixing to rectangular ducts in upright position.
- Provide free gravity actuated movement of the blade.
- Install the backdraft damper into the ventilation system with respect to the air flow direction.

Designation key

Series	Flange size [cm]
VRVS	40x20; 50x25; 50x30; 60x30; 60x35

Overall dimensions [mm]

Model	B	B1	B2	H	H1	L	Weight [kg]
VRVS 40x20	400	440	461	200	240	202	2.9
VRVS 50x25	500	540	561	200	290	202	3.73
VRVS 50x30	500	540	561	300	340	202	4.1
VRVS 60x30	600	640	661	300	340	202	4.64
VRVS 60x35	600	640	661	350	390	202	5.03

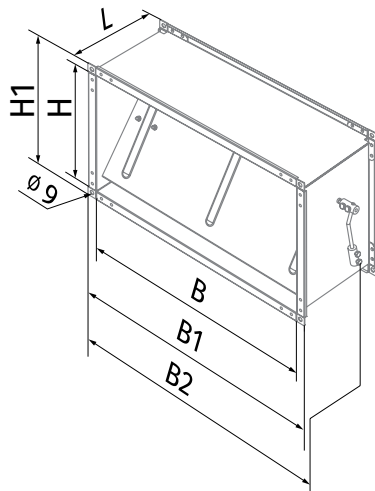

VG

Gravity air dampers for round ducts

Use

- For automatic shutoff of air ducts installed in various premises when the fan is off.
- Gravitationally actuated.
- Compatible with \varnothing 100 up to 315 mm round air ducts.



Design

- Galvanized steel case.
- Equipped with pivoted gravity louvre shutters made of PVC built inside the inner frame.
- Louvre shutters are opened by air pressure and are closed automatically when the fan is off.
- The spigot is equipped with rubber seals.

Mounting

- Fixed inside round ventilation ducts.
- Provide free gravity actuating of the louvre shutters.
- While mounting into the ventilation system match air flow direction.

Designation key

Series	Connected air duct diameter [mm]
VG	100; 125; 140; 150; 150; 160; 200; 250; 315

Overall dimensions [mm]

Model	\varnothing D	B	H	L	Weight [kg]
VG 100	99	225	216	232	1.81
VG 125	124	225	216	232	1.79
VG 140	139	225	216	232	1.79
VG 150	149	225	216	232	1.77
VG 160	159	225	216	232	1.69
VG 200	199	295	316	232	2.76
VG 250	249	295	316	232	2.62
VG 315	314	365	366	232	3.23

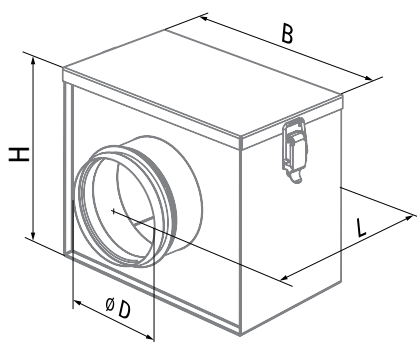

VG

Gravity air dampers for rectangular ducts

Use

- For automatic shutoff of air ducts installed in various premises when the fan is off.
- Gravitationally actuated.
- Compatible with 400x200 up to 1000x500 mm rectangular air ducts.

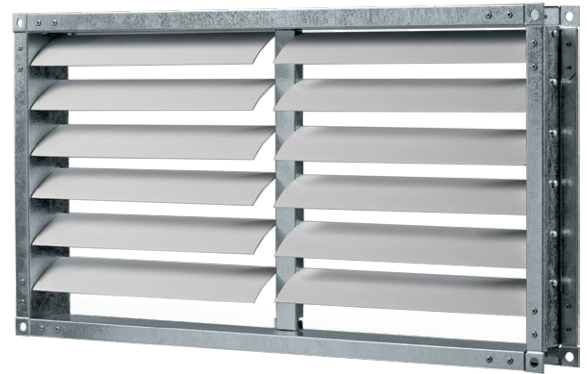

Design

- Galvanized steel case.
- Equipped with pivoted gravity louvre shutters made of PVC built into a frame.
- Louvre shutters are opened by air pressure and are closed automatically when the fan is off.

Designation key	
Series	Flange size [cm]
VG	40x20; 50x25; 50x30; 60x30; 60x35; 70x40; 80x50; 90x50; 100x50

Overall dimensions [mm]

Model	B	B1	H	H1	Weight [kg]
VG 40x20	400	440	200	240	1.29
VG 50x25	500	540	250	290	1.58
VG 50x30	500	540	300	340	1.83
VG 60x30	600	640	300	340	2.05
VG 60x35	600	640	350	390	2.21
VG 70x40	700	740	400	440	3.0
VG 80x50	800	840	500	540	3.6
VG 90x50	900	940	500	540	3.8
VG 100x50	1000	1040	500	540	4.0

Mounting

- Fixing to rectangular ducts in upright position.
- Provide free gravity actuating of the louvre shutters.
- While mounting into the ventilation system match air flow direction.

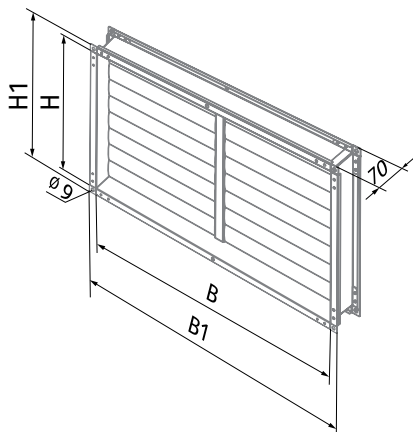
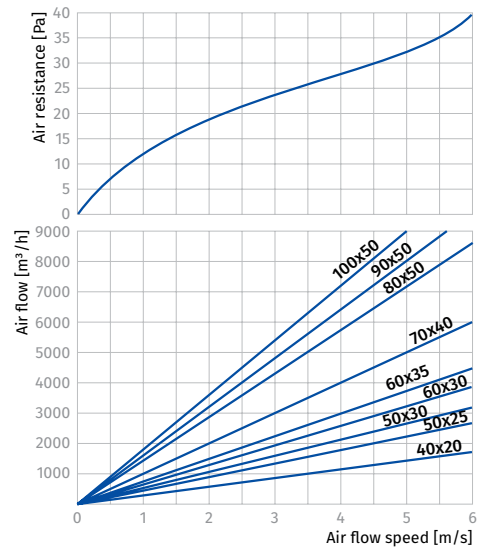

GRAVITY AIR DAMPERS

EVA

Flexible antivibration connector for round ducts

Use

- For damping vibration generated by fans or ventilation equipment and transferred to air ducts.
- For partial compensation of ductwork distortion resulting from temperature changes.
- Compatible with Ø 100 up to 500 mm round air ducts.

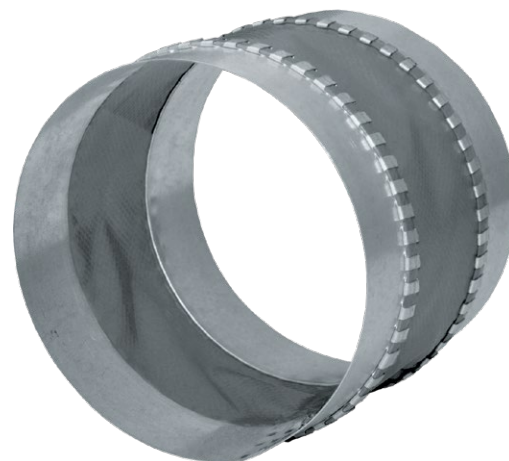

Design

- Two galvanized steel flanges.
- Connecting vibration-isolating material is made of nylon reinforced polyethylene fabric.
- Not designed for mechanical load and cannot be used as a load-carrying structure.

Mounting

- Flexible vibration damping connectors are fixed to air ducts with clamps.

Designation key

Series	Connected air duct diameter [mm]
EVA	100; 125; 150; 160; 200; 250; 315; 355; 400; 450; 500

Overall dimensions [mm]

Model	Ø D	L	Weight [kg]
EVA 100	101	130	0.14
EVA 125	126	130	0.17
EVA 150	151	130	0.21
EVA 160	161	130	0.22
EVA 200	201	130	0.28
EVA 250	251	130	0.35
EVA 315	316	130	0.44
EVA 355	356	130	0.50
EVA 400	401	130	0.56
EVA 450	451	130	0.64
EVA 500	501	130	0.71

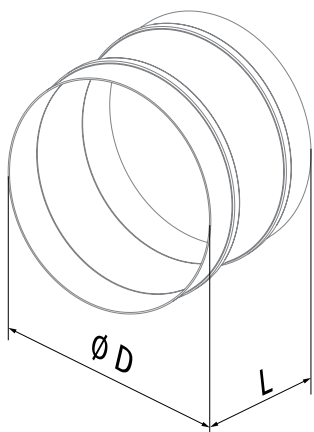

EVAF

Flexible antivibration connector for round ducts



Use

- For damping the vibration generated by fans or ventilation equipment and transferred to air ducts in ventilation systems of various premises.
- For partial compensation of ductworks temperature deformation.
- Compatible with \varnothing 200 up to 630 mm round air ducts with flanges.

Design

- Two flanges are made of galvanized steel.
- The connecting vibration-isolating material is made of nylon reinforced polyethylene fabric.
- Not designed for mechanical load and cannot be used as a load carrying structure.

Mounting

- Flexible vibration damping connectors are fixed to air ducts with flange connection.

Designation key	
Series	Connected air duct diameter [mm]
EVAF	200; 250; 300; 350; 400; 450; 500; 550; 630

Overall dimensions [mm]

Model	$\varnothing D$	$\varnothing D1$	L	Weight [kg]
EVAF 200	205	255	160	1.29
EVAF 250	260	306	160	1.21
EVAF 300	310	382	160	1.90
EVAF 350	362	421	160	2.06
EVAF 400	412	465	160	2.57
EVAF 450	462	515	160	2.88
EVAF 500	515	570	160	3.81
EVAF 550	565	636	160	4.53
EVAF 630	645	715	160	5.13

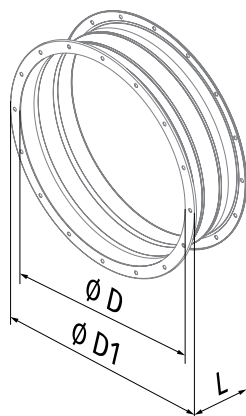

EVA

Flexible antivibration connector for rectangular ducts

Use

- For damping of vibration generated by fans or ventilation equipment and transferred to air ducts for ventilation systems installed in various premises.
- For partial temperature distortion compensation in the ductworks.
- Compatible with rectangular 400x200 up to 1000x500 mm air ducts.



Design

- Two galvanized steel flanges.
- Connecting vibration-isolating material is made of nylon reinforced polyethylene fabric.
- Not designed for mechanical load and cannot be used as a load-carrying structure.

Mounting

- Mounting with galvanized bolts and clamps that fix the end flanges of the connector to the mating flanges of the air ducts or any other ventilation system components.

Designation key

Series	Flange size (WxH) [cm]
EVA	40x20; 50x25; 50x30; 60x30; 60x35; 70x40; 80x50; 90x50; 100x50

Overall dimensions [mm]

Model	B	B1	H	H1	Weight [kg]
EVA 40x20	400	440	200	240	1.1
EVA 50x25	500	540	250	290	1.4
EVA 50x30	500	540	300	340	1.6
EVA 60x30	600	640	300	340	1.82
EVA 60x35	600	640	350	390	1.95
EVA 70x40	700	740	400	440	2.4
EVA 80x50	800	840	500	540	2.8
EVA 90x50	900	940	500	540	3.0
EVA 100x50	1000	1040	500	540	3.2

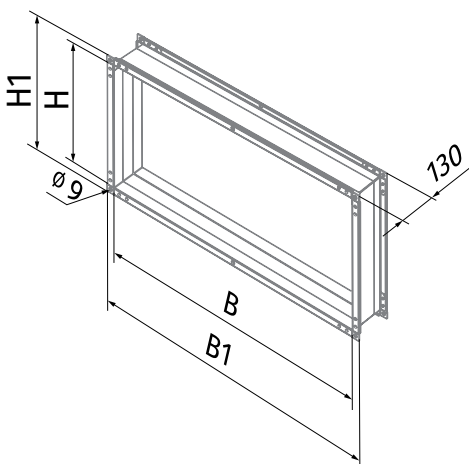

Clean Box

Filter boxes for round ducts

Use

- For purification of supply air in ventilation and air conditioning systems installed in various premises
- Suitable for limited mounting space.
- Compatible with Ø 100 up to 200 mm round air ducts.



Design

- The casing is made of polymer-coated steel.
- Easy access for filter maintenance.

Mounting

- Due to compact design is the ideal solution for mounting in limited spaces, including the space behind false ceiling.
- Any mounting position.
- Wall or ceiling mounting with fixing brackets supplied as a standard.

Air filtration

- Built-in filters provide efficient air filtration. Up to three filters can be installed into the casing.
- G4** filter provides primary filtration. At the second stage, the secondary filter **F8** or **HEPA** filter **H13** can be installed. F8 filter arrests up to 98 % of PM2.5 dust particles. **H13** filter arrest up to 99 % of PM2.5 dust particles, pollen and bacteria. For additional elimination of odors and gases carbon filter can be installed.
- Quick access to replaceable filters through service panel.

Electrostatic filter

- The **Clean Box ES** is equipped with an electrostatic filter that enables purification of air from fine dust and soot, spray, smoke and other particles with the size of 0.01 microns and less.
- Max. filter cleaning efficiency 98 %.
- The electrostatic filters rely on gravity of oppositely charged objects.
- The polluted air stream flows through the spray charging unit for the particles ionization.
- Ionized particles are moved by the airstream and accumulated on the collecting plates which are oppositely charged.

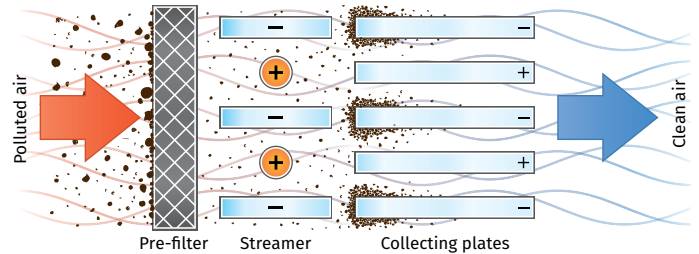

- The filter cleaning interval depends on the inlet air pollution density and may vary from 7 up to 21 days.
- The filter cleaning interval is determined by the visual inspection of the filters.
- Vacuum cleaning is allowed.

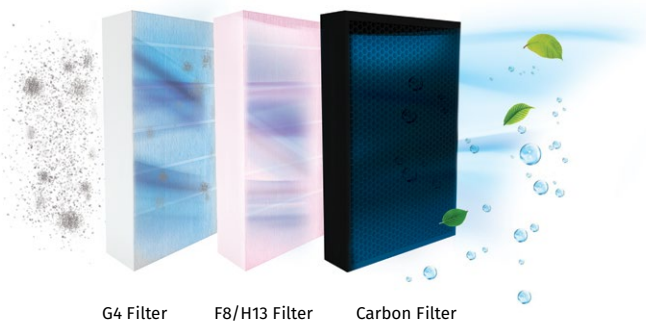

G4 Filter

F8/H13 Filter

Carbon Filter

Designation key

Series	Duct diameter [mm]	Filters
Clean Box	100; 125; 150; 200	G4; G4-F8; G4-F8-Carbon; G4-H13; G4-H13-Carbon; ES

Accessories

Air disc valves	Duct system	Flexible air ducts	Grilles and hoods	Clamps
VPR / VSR / VMR	BlauPlast	BlauFlex	Decor / GM	K / KZ

Overall dimensions [mm]

Type	∅ D	L	H	B	L1	B1	L2	B2	Weight [kg]
Clean Box 100 G4-F8	100	413.5	249	415	513.5	508	358.5	458	7.47
Clean Box 100 G4-F8-Carbon	100	413.5	249	415	513.5	508	358.5	458	8.17
Clean Box 100 G4-H13	100	413.5	249	415	513.5	508	358.5	458	7.47
Clean Box 100 G4-H13-Carbon	100	413.5	249	415	513.5	508	358.5	458	8.18
Clean Box 100 ES	100	514	250	458	614	551	456	502	11.5
Clean Box 125 G4-F8	125	413.5	249	415	513.5	508	358.5	458	7.47
Clean Box 125 G4-F8-Carbon	125	413.5	249	415	513.5	508	358.5	458	8.17
Clean Box 125 G4-H13	125	413.5	249	415	513.5	508	358.5	458	7.47
Clean Box 125 G4-H13-Carbon	125	413.5	249	415	513.5	508	358.5	458	8.18
Clean Box 150 G4-F8	150	413.5	299	440	513.5	508	358.5	483	8.47
Clean Box 150 G4-F8-Carbon	150	413.5	299	440	513.5	508	358.5	483	9.04
Clean Box 150 G4-H13	150	413.5	299	440	513.5	508	358.5	483	8.47
Clean Box 150 G4-H13-Carbon	150	413.5	299	440	513.5	508	358.5	483	9.04
Clean Box 150 ES	150	514	300	458	614	551	456	502	12.7
Clean Box 200 G4-F8	200	413.5	299	605	513.5	508	358.5	648	10.62
Clean Box 200 G4-F8-Carbon	200	413.5	299	605	513.5	508	358.5	648	11.84
Clean Box 200 G4-H13	200	413.5	299	605	513.5	508	358.5	648	10.62
Clean Box 200 G4-H13-Carbon	200	413.5	299	605	513.5	508	358.5	648	11.84
Clean Box 200 ES	200	514	300	658	614	751	456	702	16.8

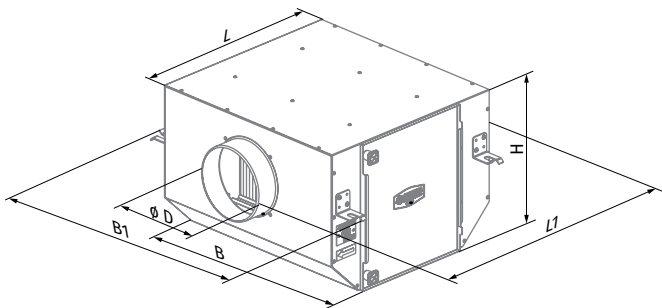

Application



FILTER BOXES

Replaceable filters

	Clean Box 100 (ES*) Clean Box 125	Clean Box 150 (ES*)	Clean Box 200 (ES*)
G4 Panel filter	FP 220x400x47 G4	FP 270x425x47 G4	FP 270x590x47 G4
F8 Panel filter	FP 220x400x47 F8	FP 270x425x47 F8	FP 270x590x47 F8
H13 Panel filter	FP 220x400x47 H13	FP 270x425x47 H13	FP 270x590x47 H13
Carbon panel filter	FP 220x400x47 C	FP 270x425x47 C	FP 270x590x47 C

* By default models with electrostatic filters ES are equipped with pre-filters G4. The G4 filter can be replaced by either F8, H13 or a carbon filter on request.

Technical data

CLEAN BOX 100

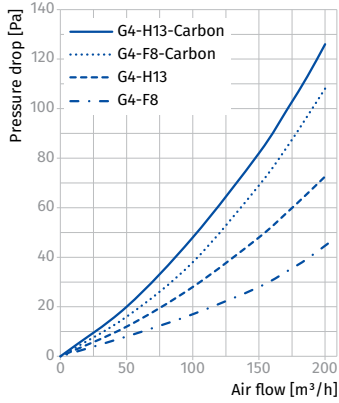

CLEAN BOX 125

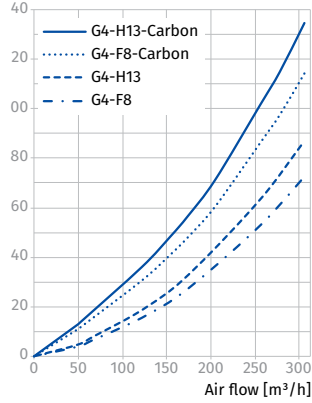

CLEAN BOX 150

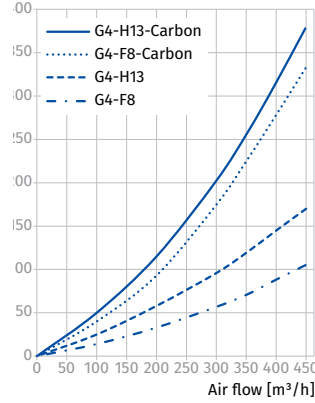

CLEAN BOX 200

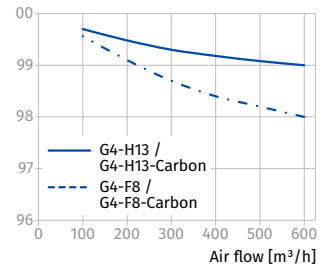
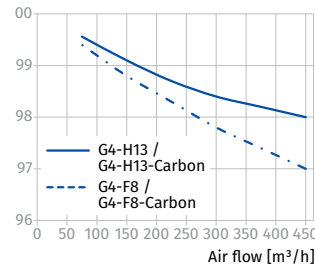
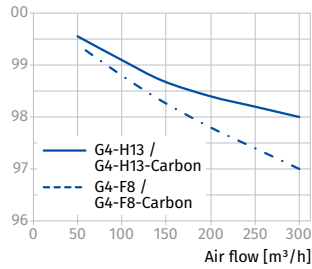
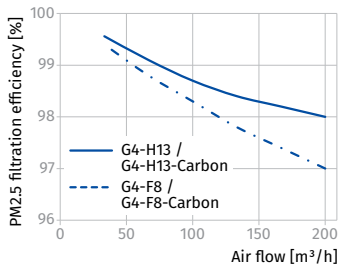
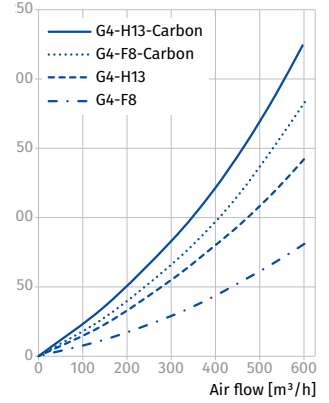

CLEAN BOX 100 ES

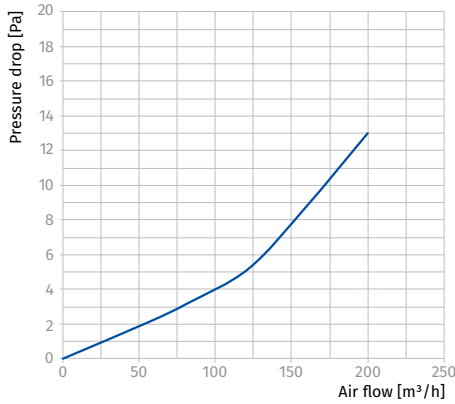

CLEAN BOX 150 ES

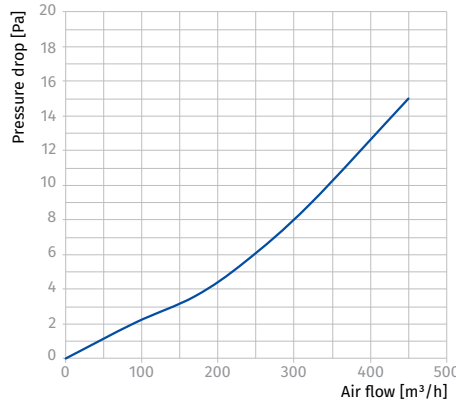

CLEAN BOX 200 ES

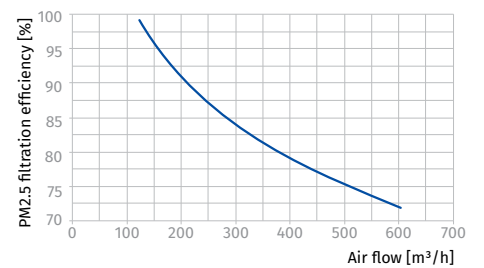
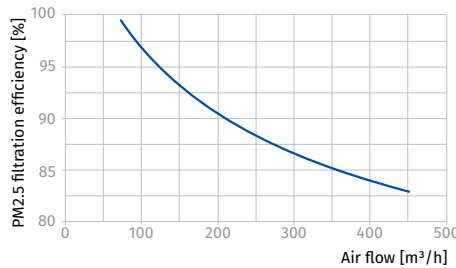
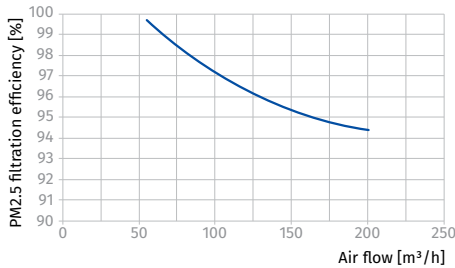
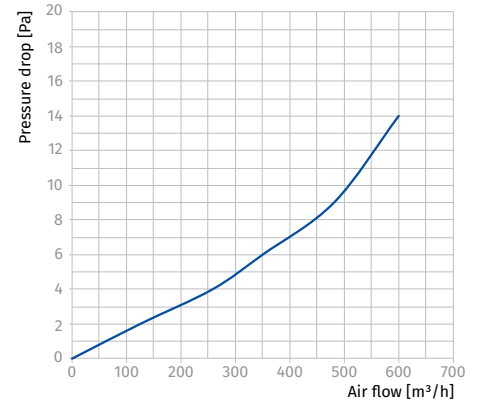

FILTER BOXES

KFBK

Filter boxes for round ducts

Use

- For purification of supply or extract air in ventilation and air conditioning systems installed in various premises.
- Designed for protection of air ducts, heat exchangers, fans, controls and other ventilation system equipment against dust pollution.
- Prevent contamination of walls and ceilings located near the system.
- Can be used as pre-filters installed upstream to more efficient filters.
- Compatible with Ø 100 up to 315 mm round air ducts.



Design

- Galvanized steel case.
- Airtight connection of the filter-box with air ducts due to connecting flanges with a rubber seal.
- Equipped with a flat filter cartridge made of synthetic non-woven cloth with filtration class **G4**.
- Filter cartridge is fixed on a steel wire frame.
- Quick access to replaceable filter cartridge due to lever locks on the casing.

Mounting

- Fixing to round ducts with clamps.
- Any mounting position.
- While mounting provide extra space for free access to the filter for servicing.

Accessories

- **G4** replaceable flat filter cartridges made of synthetic non-woven cloth series **FP KFBK**.



Designation key

Series	Connected air duct diameter [mm]	Filters
KFBK	100; 125; 150; 160; 200; 250; 315	G4

Overall dimensions [mm]

Model	Ø D	B	H	L	L1	Weight [kg]
KFBK 100 G4	99	210	175	215	123	1.4
KFBK 125 G4	124	220	209	235	143	1.7
KFBK 150 G4	149	270	237	250	158	2.5
KFBK 160 G4	159	270	237	250	158	2.3
KFBK 200 G4	199	320	279	275	183	3.1
KFBK 250 G4	249	370	327	325	233	4.5
KFBK 315 G4	314	430	392	425	333	6.7

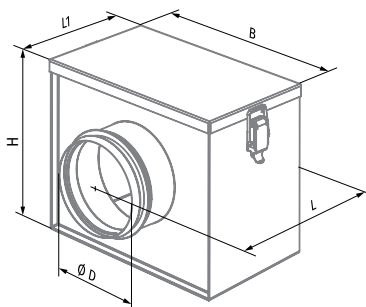

Filtration class G4

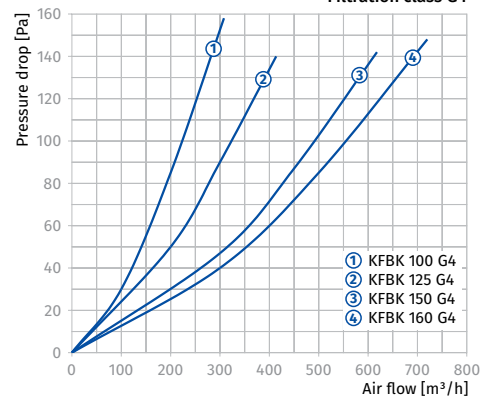

Filtration class G4

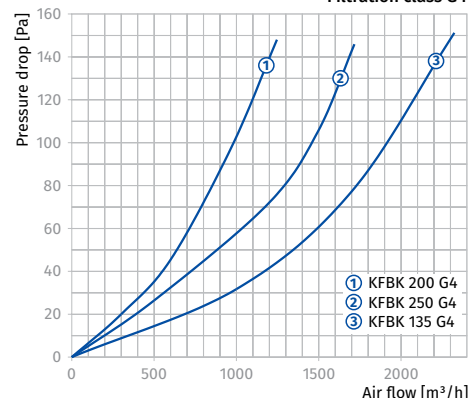

KFBV

Filter boxes with V-filter for round ducts



Use

- For purification of supply or exhaust air in ventilation and air conditioning systems installed in various premises.
- Designed for protection of air ducts, heat exchangers, fans, controls and other ventilation system equipment against dust pollution.
- Prevent contamination of walls and ceilings located near the system.
- Can be used as pre-filters installed upstream to more efficient filters.
- Compatible with \varnothing 100 up to 315 mm round air ducts.

Design

- Galvanized steel case.
- Airtight connection of the filter-box with air ducts due to connecting flanges with a rubber seal.
- Equipped with a V-shaped filter cartridge with increased filter surface made of synthetic non-woven cloth with G4 filtration class.
- Filter cartridge is fixed on a steel wire frame.
- Quick access to replaceable filter cartridge due to lever locks on a swivel filter cover.

Mounting

- Fixing to round ducts with clamps.
- Any mounting position.
- While mounting provide extra space for free access to the filter for servicing.

Accessories

- G4 replaceable V-shaped filter cartridges made of synthetic non-woven cloth series FP KFBV.



Designation key		
Series	Connected air duct diameter [mm]	Filters
KFBV	100; 125; 150; 160; 200; 250; 315	G4

Overall dimensions [mm]

Model	$\varnothing D$	B	H	L	L1	Weight [kg]
KFBV 100 G4	99	233	175	215	123	1.4
KFBV 125 G4	124	243	209	235	143	1.7
KFBV 150 G4	149	293	237	250	158	2.2
KFBV 160 G4	159	293	237	250	158	2.2
KFBV 200 G4	199	343	279	275	183	3.1
KFBV 250 G4	249	393	327	325	233	4.2
KFBV 315 G4	314	453	392	425	333	6.3

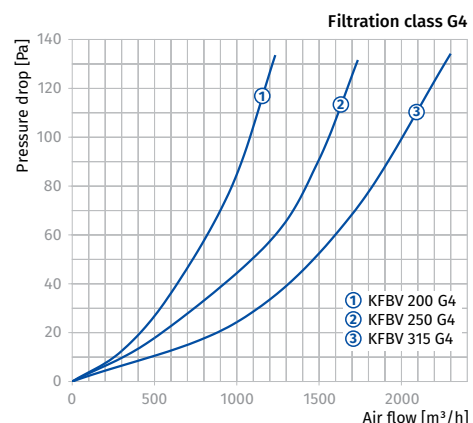
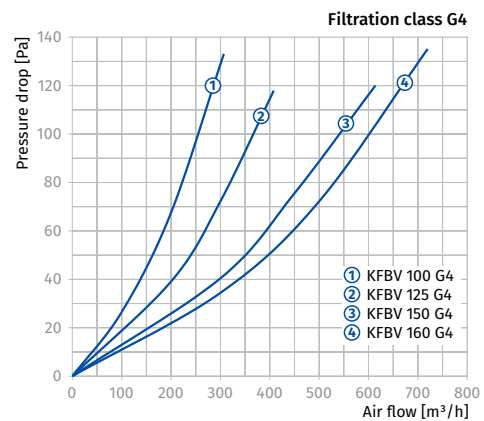
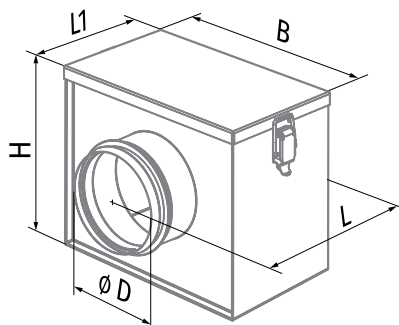

KFBT

Filter boxes with pocket filters for round ducts

Use

- For purification of supply or exhaust air in ventilation and air conditioning systems installed in various premises.
- Designed for protection of air ducts, heat exchangers, fans, controls and other ventilation system equipment against dust pollution.
- Prevent contamination of walls and ceilings located near the system.
- Can be used as pre-filters installed upstream to more efficient filters.
- Compatible with \varnothing 100 up to 315 mm round air ducts.



Design

- Galvanized steel case.
- Airtight connection of the filter-box with air ducts due to connecting flanges with a rubber seal.
- Equipped with a replaceable filter bag made of synthetic non-woven cloth with filtration class **G4, F5, F7**.
- Filter cartridge is fixed on a steel wire frame.
- Quick access to replaceable filter cartridge due to lever locks on a swivel filter cover.

Mounting

- Fixing to round ducts with clamps.
- Any mounting position.
- In case of vertical mounting position provide air stream downwards to avoid filter Yesmming.
- While mounting provide extra space for free access to the filter for servicing.

Accessories

- G4, F5, F7** replaceable filter bags made of synthetic non-woven cloth series **FP KFBT**.



Designation key

Series	Connected air duct diameter [mm]	Filters
KFBT	100; 125; 150; 160; 200; 250; 315	G4; F5; F7

Overall dimensions [mm]

Model	\varnothing D	B	B1	H	Weight [kg]
KFBT 100	99	210	230	170	2.41
KFBT 125	124	220	240	206	2.69
KFBT 150	149	270	290	236	3.20
KFBT 160	159	270	290	236	3.26
KFBT 200	199	320	340	276	3.76
KFBT 250	249	370	390	386	4.39
KFBT 315	314	430	450	390	5.17

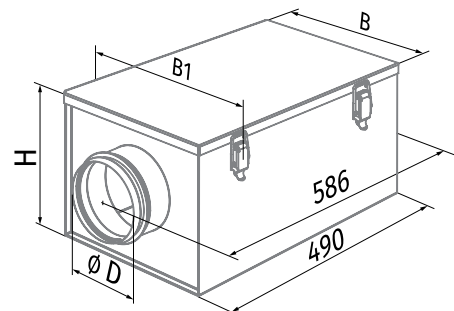

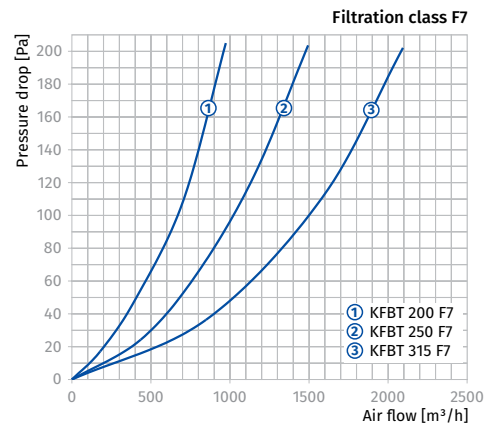
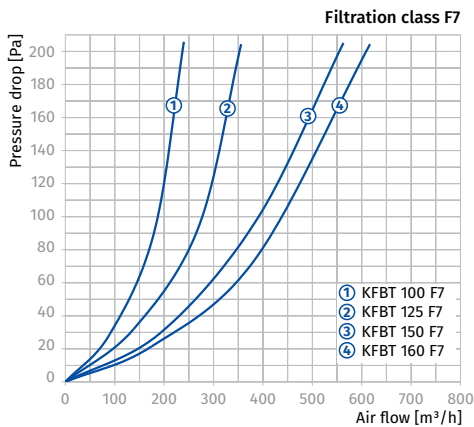
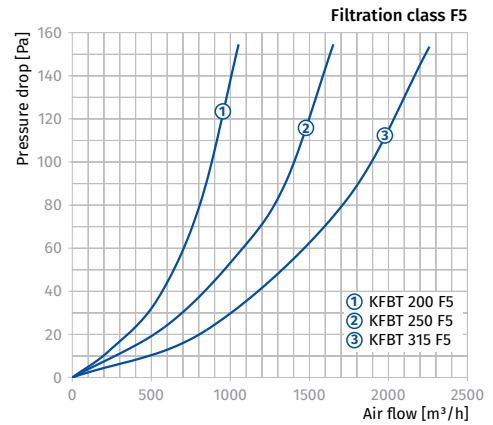
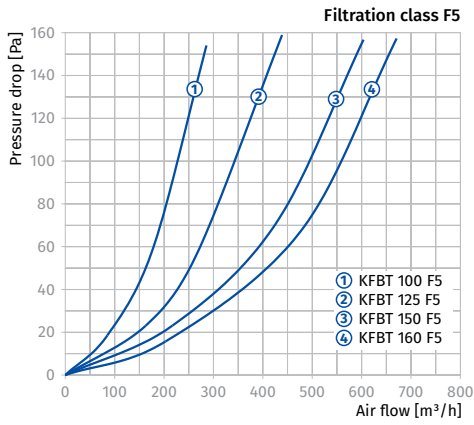
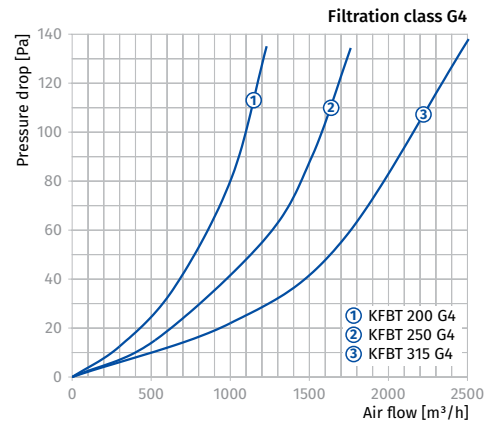
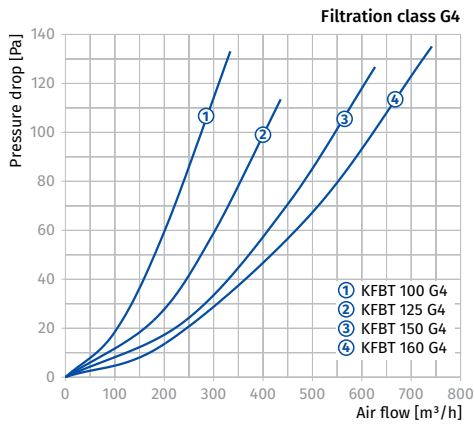

KFBT

Filter boxes with pocket filters for rectangular ducts

Use

- For purification of supply or exhaust air in ventilation and air conditioning systems installed in various premises.
- Designed for protection of air ducts, heat exchangers, fans, controls and other ventilation system equipment against dust pollution.
- Prevent contamination of walls and ceilings located near the system.
- Can be used as pre-filters installed upstream to more efficient filters.
- Compatible with 400x200 up to 1000x500 mm rectangular air ducts.



Design

- Galvanized steel case.
- Equipped with a replaceable filter bag made of synthetic non-woven cloth with filtration class **G4, F5, F7**.
- Filter cartridge is fixed on a steel wire frame.
- Quick access to replaceable filter cartridge due to lever locks on a swivel filter cover.

Mounting

- Fixing to rectangular ducts with flange connection.
- Any mounting position.
- In case of vertical mounting position provide air stream downwards to avoid filter pockets creasing.
- While mounting provide extra space for free access to the filter for servicing.

Accessories

- G4, F5, F7** replaceable filter bags made of synthetic non-woven cloth series **FP KFBT**.



Designation key

Series	Flange size (WxH) [cm]	Filters
KFBT	40x20; 50x25; 50x30; 60x30; 60x35; 70x40; 80x50; 90x50; 100x50	G4; F5; F7

Overall dimensions [mm]

Model	B	B1	H	H1	L	Weight [kg]
KFBT 40x20	400	440	200	240	500	6.2
KFBT 50x25	500	540	250	290	600	7.8
KFBT 50x30	500	540	300	340	600	8.3
KFBT 60x30	600	640	300	340	600	8.9
KFBT 60x35	600	640	350	390	600	9.5
KFBT 70x40	700	740	400	440	720	16.2
KFBT 80x50	800	840	500	540	800	20.4
KFBT 90x50	900	940	500	540	800	21.7
KFBT 100x50	1000	1040	500	540	800	23.5

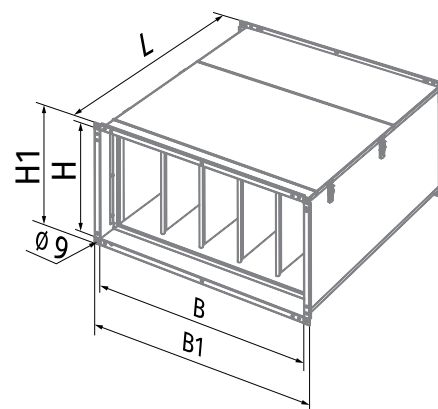

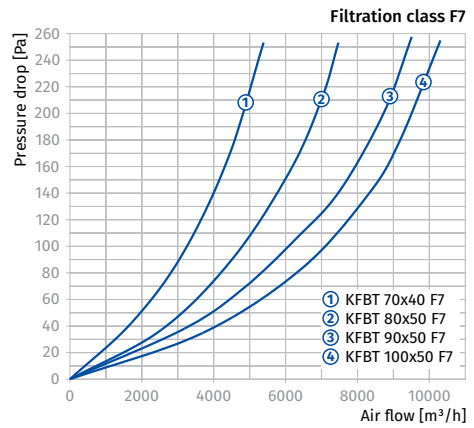
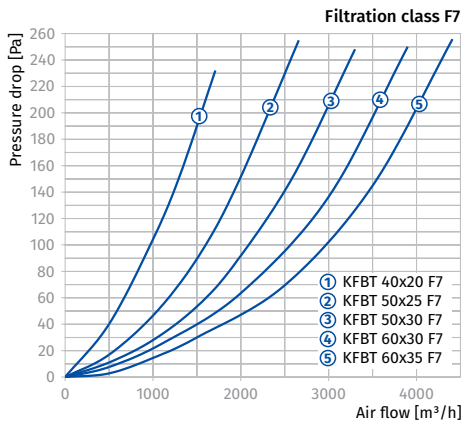
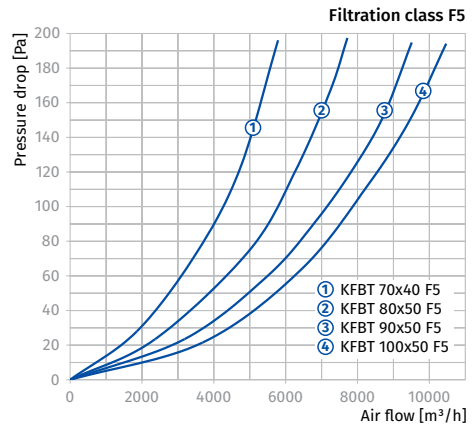
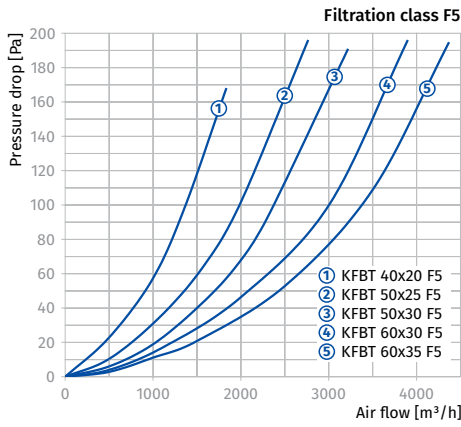
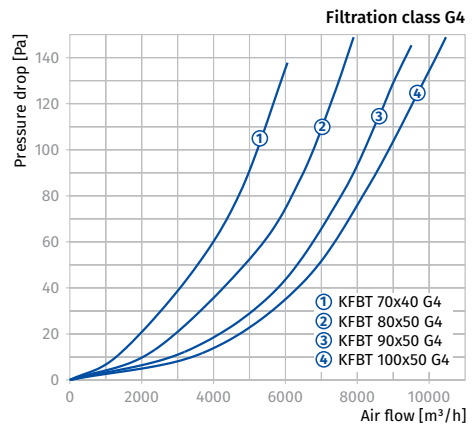
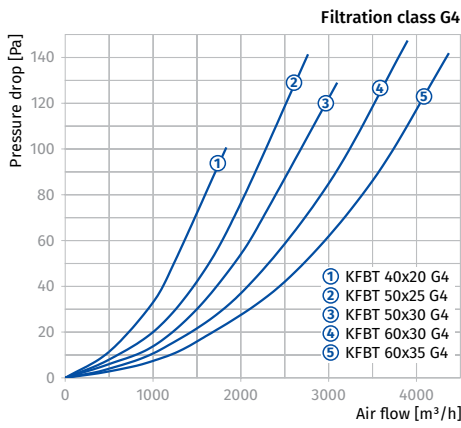

KFBK

Filter boxes with panel filter for rectangular ducts

Use

- For purification of supply or exhaust air in ventilation and air conditioning systems installed in various premises.
- Designed for protection of air ducts, heat exchangers, fans, controls and other ventilation system equipment against dust pollution.
- Prevent contamination of walls and ceilings located near the system.
- Can be used as pre-filters installed upstream to more efficient filters.
- Compatible with 400x200 up to 1000x500 mm rectangular air ducts.

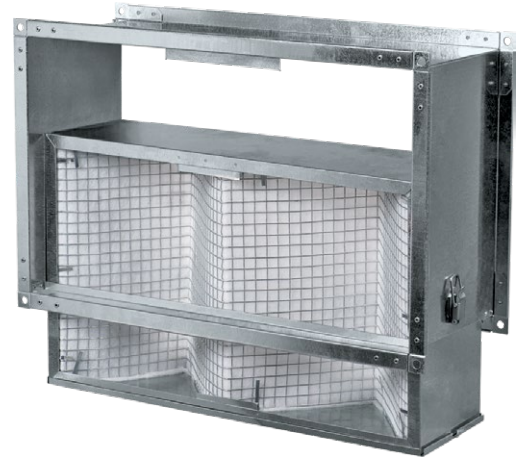

Design

- Galvanized steel case.
- Equipped with a filter cartridge made of synthetic non-woven cloth with filtration class **G4**.
- Filter cartridge has manifold bending to increase the filtration surface and protected with a metal net against deformation with air pressure.
- Quick access to replaceable filter cartridge due to lever locks on a swivel filter cover.

Mounting

- Fixing to rectangular ducts with flange connection.
- Installed upstream to heater and fan following the air flow direction.
- While mounting provide extra space for free access to the filter for servicing.

Accessories

- **G4** replaceable filter cartridges made of synthetic non-woven cloth series **FP KFBK**.



Designation key

Series	Flange size (WxH) [cm]	Filters
KFBK	40x20; 50x25; 50x30; 60x30; 60x35; 70x40; 80x50; 90x50; 100x50	G4

Overall dimensions [mm]

Model	B	B1	H	H1	L	Weight [kg]
KFBK 40x20 G4	400	440	200	240	200	2.4
KFBK 50x25 G4	500	540	250	290	200	4.1
KFBK 50x30 G4	500	540	300	340	200	4.4
KFBK 60x30 G4	600	640	300	340	200	5.2
KFBK 60x35 G4	600	640	350	390	200	5.8
KFBK 70x40 G4	700	740	400	440	200	6.7
KFBK 80x50 G4	800	840	500	540	200	7.9
KFBK 90x50 G4	900	940	500	540	200	8.4
KFBK 100x50 G4	1000	1040	500	540	200	8.9

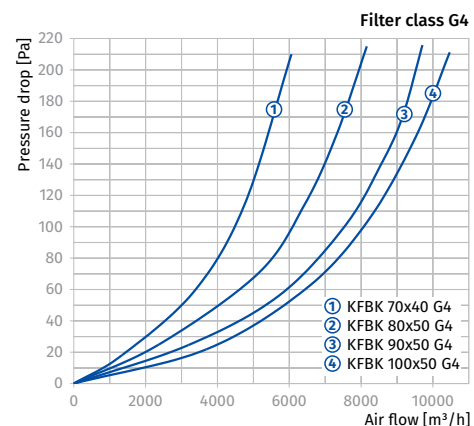
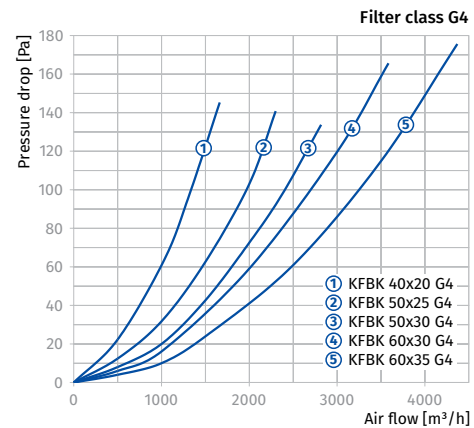
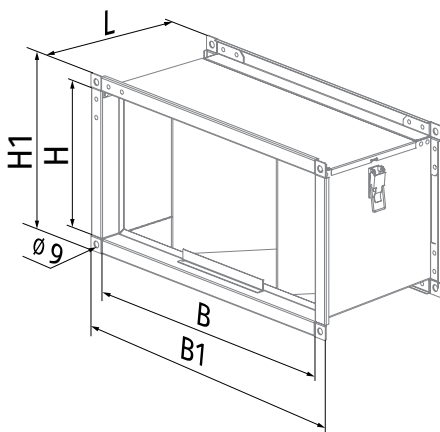

KZ

Clamps for round ducts

Use

- For reliable fixing of ventilation system components.
- Compatible with 100 up to 315 mm round ventilation system components.



Design

- Made of galvanized steel band.
- Sealed with microporous rubber from inside for vibration absorption.

Mounting

- Fixed on round ventilation system components.
- Round ventilation system components are fixed by a clamp with two bolts.

Designation key

Series	Connected air duct diameter [mm]
KZ	100; 125; 150; 160; 200; 250; 315

Overall dimensions [mm]

Model	∅ D	H	Weight [kg]
KZ 100	100	172	0.206
KZ 125	125	198	0.232
KZ 150	150	224	0.296
KZ 160	160	232	0.358
KZ 200	200	274	0.42
KZ 250	250	326	0.55
KZ 315	315	380	0.65

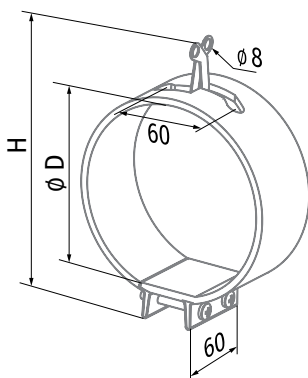

KZH

Clamps for round ducts

Use

- o For reliable fixing of ventilation system components installed in various premises.
- o Compatible with 100 up to 315 mm round ventilation system components.



Design

- o Made of galvanized steel band.
- o Sealed with microporous rubber from inside for vibration absorption.
- o Equipped with a mounting bracket for fixing on wall or ceiling.

Mounting

- o Fixed on round ventilation system components.
- o Round ventilation system components are fixed by a clamp with a bolt.
- o For installation on wall or ceiling use a mounting bracket fixed with dowels.

Designation key

Series	Connected air duct diameter [mm]
KZH	100; 125; 150; 160; 200; 250; 315

Overall dimensions [mm]

Model	Ø D	L	Weight [kg]
KZH 100	100	204	0.21
KZH 125	125	229	0.22
KZH 150	150	254	0.25
KZH 160	160	264	0.26
KZH 200	200	304	0.31
KZH 250	250	354	0.35
KZH 315	315	419	0.42

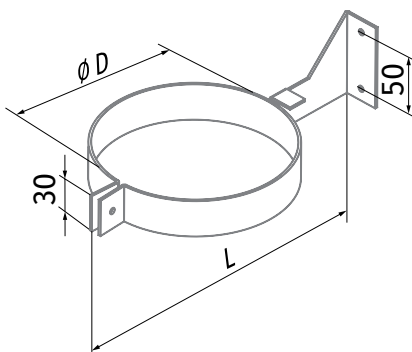

AT-25 220/12

Step-down transformer

Use

- Low-voltage step-down transformers are used to ensure safe 12 V/50 Hz power supply for residential fans with maximum motor power 16 W (25 VA) and maximum load current 2 A.



Design

- Casing made of high-quality plastic.
- Supplied with external fuse blocks.

Protection

- The transformer has overload protection by thermal fuse.
- IP40 ingress protection rating except for the fuse blocks.

Mounting

- Indoor installation in areas not subjected to high temperature and humidity.
- Suitable for flush mounting behind the false ceiling or wall recess mounting provided that sufficient ventilation is ensured to prevent overheating.
- Do not install the transformer above heating equipment.

Technical data

Parameters	AT-25 220/12
Input voltage [V]	1 ~ 230
Output voltage [V]	12
Frequency [Hz]	50
Max. power [W]	16 (25 VA)
Maximum load current [A]	2.0
Overall dimensions WxHxD [mm]	
Transformer:	91x58x62
Fuse block:	110x40x40
Max. transported air temperature [°C]	+40
IP rating	IP40
Weight [kg]	0.8

Wiring diagram

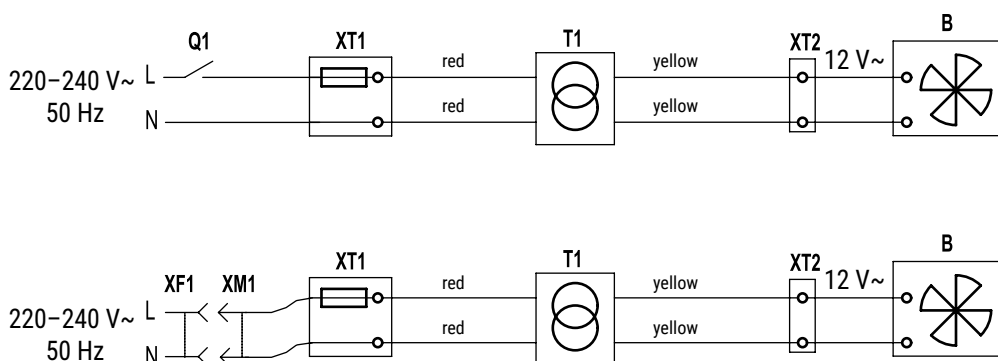

Q1: external switch integrated into the fixed wiring system;
 XT1: input fuse block with a built-in thermal fuse in a protecting casing;
 XF1: socket integrated into the fixed wiring system;
 XM1: standard plug;
 T1: transformer;
 XT2: output fuse block for safe 12 V fan connection;
 B: fan with safe 12 V voltage.

ATK-25 220/12

Step-down transformer



Use

- Low-voltage step-down transformers are used to ensure safe 12 V/50 Hz power supply for residential fans with maximum motor power 16 W (25 VA) and maximum load current 2 A.

Design

- Compact casing made of high-quality plastic.
- ATK-25 220/12 S:** the transformer is equipped with a pull-cord switch and a light indicator.

Protection

- The transformer has overload protection by thermal fuse.

Mounting

- Indoor installation in areas not subjected to high temperature and humidity.
- Designed for wall surface mounting. Provide free air circulation for cooling of internal circuits.
- Do not install the transformer above the heating equipment.

Technical data

Parameters	ATK-25 220/12
Input voltage [V]	1 ~ 230
Output voltage [V]	12
Frequency [Hz]	50
Max. power [W]	16 (25 VA)
Maximum load current [A]	2.0
Overall dimensions WxHxD [mm]	162x80x63
Max. transported air temperature [°C]	+40
IP rating	IP40
Weight [kg]	0.85

Wiring diagram

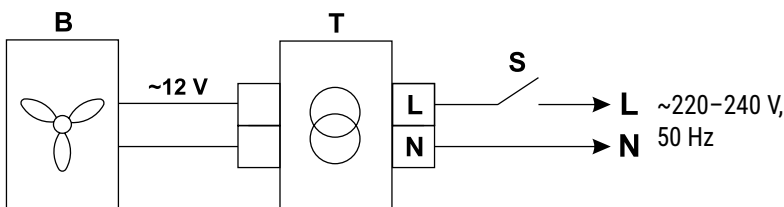
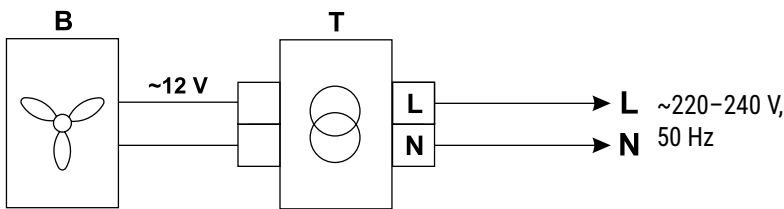

B: fan with safe 12 V voltage;
 T: protecting transformer;
 S: external switch.

AT-40 230/12

Step-down transformer

Use

- Low-voltage step-down transformers are used to ensure safe 12 V/50 Hz power supply for the ventilation products with maximum load power 40 W and load current not exceeding 3.3 A.
- Compatible with Vento air handling units.



Design

- Compact casing made of high-quality plastic.
- The casing includes two sealed electric lead-ins and 2x0.75 m² power cables.
- 3 m power cable and a standard electric plug at the transformer input for connection to 220–240 V/50 Hz power mains.
- 2 m 12 V/50 Hz power cable with a special contact socket for the Vento air handling unit connection at the transformer output.

Protection

- The transformer has overload protection by thermal fuse.
- IP40 ingress protection rating except for the fuse blocks.

Mounting

- Indoor installation.
- Flush mounting behind the suspended ceiling or wall recess mounting in a well ventilated areas to prevent overheating.
- No installation above heating equipment.

Wiring diagram

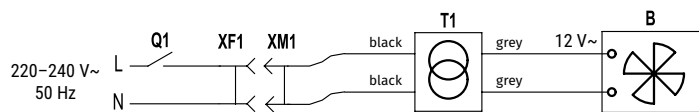

T1: transformer;
B: 12 V / 50 Hz ventilation equipment;
XM1: standard plug;
XF1: socket integrated into the fixed wiring system;
Q1: external switch integrated into fixed wiring system.

Technical data

Parameters	AT-40 230/12
Input voltage [V]	1 ~ 230
Output voltage [V]	12
Frequency [Hz]	50
Max. load power [W]	40
Max. current load [A]	3.0
Max. ambient temperature [°C]	+40
IP rating	IP40
Weight [kg]	1.1

Overall dimensions [mm]

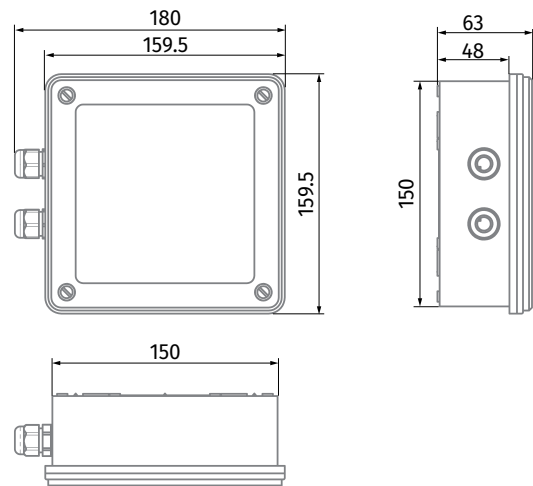

SGR-3/1

Sensor speed switch

Use

- On/off switch and speed selection for multi-speed fans.



Design

- Casing made of high-quality plastic.
- Glass sensor operating panel with three touch buttons for speed selection with light indication.
- Wall flush mounting.
- IP30 ingress protection rating.

Control

- Required speed is activated by touching the respectively marked speed button.
- The fan is turned off by touching the current speed button.

Mounting

- Designed for wall mounting in a flush mounting box.

Technical data

Parameters	SGR-3/1
Voltage [V]	110–240
Frequency [Hz]	50/60
Max. current load [A]	1
Number of speeds	3
Cable cross section [mm ²]	0.35 ... 1
Temperature range [°C]	-10 ... +45
Operating humidity range [%]	5 ... 80 (no condensation)
Service life	100 000 operations
IP rating	IP30
Weight [g]	138

SPEED CONTROLLERS

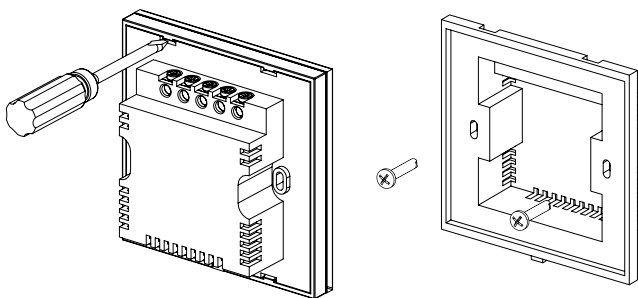

Wiring diagram

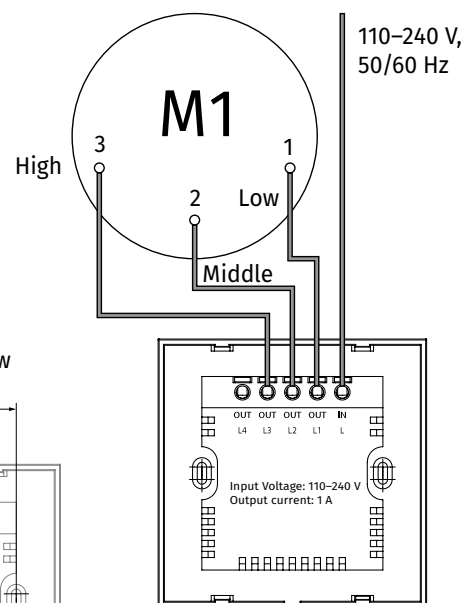

Overall dimensions [mm]

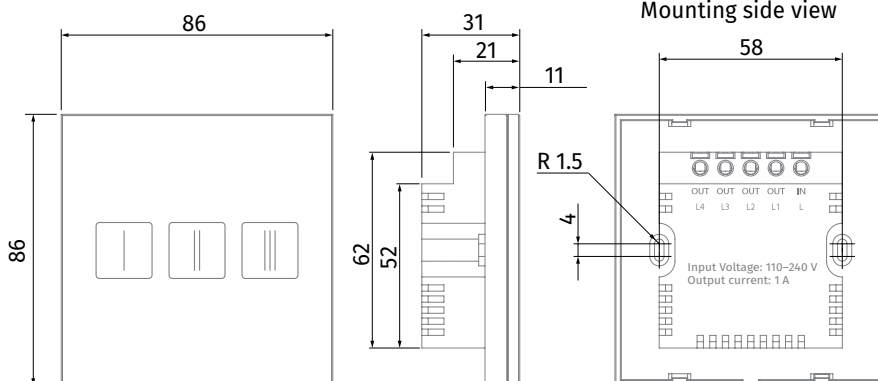

SGS E1

Sensor speed controller

Use

- On/off switch and speed control for single-phase voltage controlled fans.



Design

- Casing made of high-quality plastic.
- Glass sensor panel with an ON/OFF button and two speed control buttons.
- The adjustable speed is displayed with the LED indicator.
- Wall flush mounting.
- IP30 ingress protection rating.

Mounting

- Designed for wall mounting in a flush mounting box.

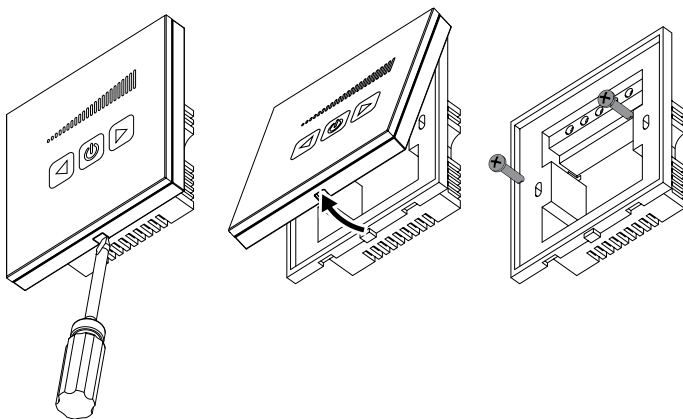

Overall dimensions [mm]

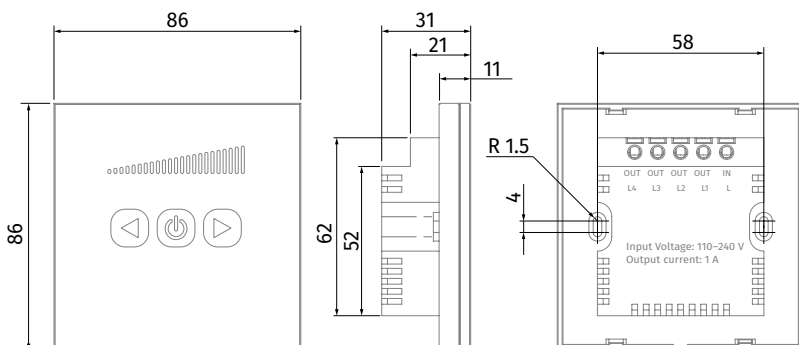

Technical data

Parameters	SGS E1
Voltage [V]	1 ~ 230
Frequency [Hz]	50/60
Max. current load [A]	1
Cable cross section [mm ²]	0.35 ... 1
Temperature range [°C]	-10 ... +45
Operating humidity range [%]	5 ... 80 (no condensation)
Service life	100 000 operations
IP rating	IP30
Weight [g]	138

Wiring diagram

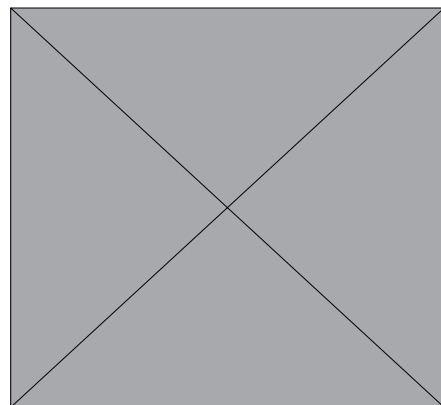

CDP-2/10

Multi-speed switch

Use

- Speed on/off switch and speed changeover for multi-speed fans
- Wall mounting in a flush mounting box
- Suitable for installation in standard electric junction boxes



Control

- Direct fan speed switching.

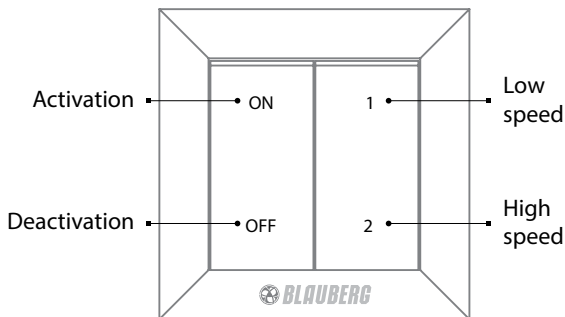

Technical data

Parameters	CDP-2/10
Max. voltage [V]	250
Frequency [Hz]	50/60
Max. current load [A]	10
Cable cross section [mm ²]	0.35 ... 0.75
Temperature range [°C]	-10 ... +45
Operating humidity range [%]	5 ... 80 (no condensation)
Service life	1 000 000 switching operations
Weight [g]	98

Wiring diagram

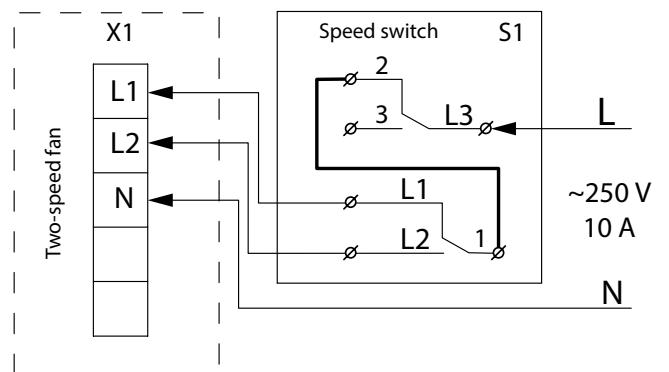

Overall dimensions [mm]

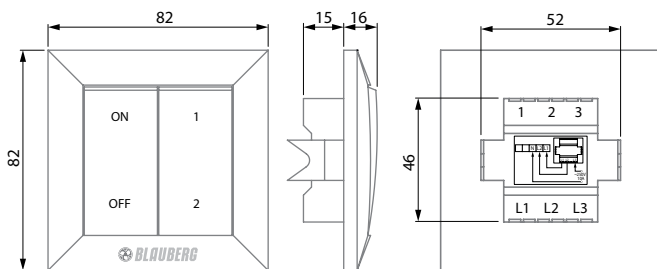

CDP-2/5 (3/5)

Multi-speed switches



Use

- On/off switch and speed switch for multi-speed fans.

Design

- Casing made of high-quality plastic.
- Flush wall mounting.
- IP40 ingress protection rating.

Control

- Switching of fan speed according to diagram 1 and switching of fan speed in parallel with switching the light in the room, diagram 2.

Mounting

- Indoor wall flush mounting in a mounting box.
- Suitable for installation in standard electric junction boxes.

Wiring diagram

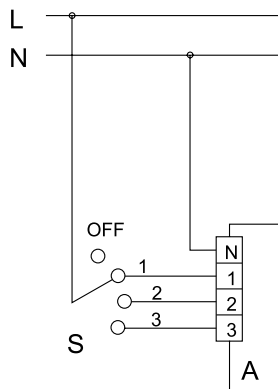

Diagram 1. The external switch **S (CDP-3/5)** switches the fan to one of three speeds and switches it off.

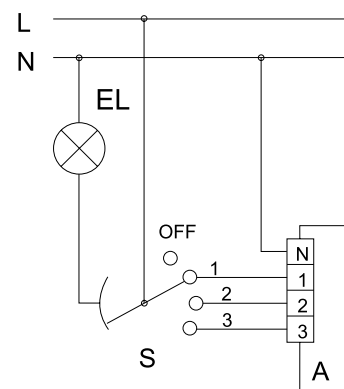

Diagram 2. The external switch **S (CDP-3/5)** switches the fan to one of three speeds and switches it off with parallel switching on/off the light in the room.

Technical data

Parameters	CDP-2/5	CDP-3/5
Voltage [V]	1 ~ 230	1 ~ 230
Frequency [Hz]	50/60	50/60
Rated current [A]	3.0	3.0
Number of speeds	2	3
Overall dimensions WxHxD [mm]	88x88x51	88x88x51
Transported air temperature [°C]	+40	+40
IP rating	IP40	IP40

CDT E1.8

Thyristor speed controller

Use

- For switching fans on/off and for speed control of single-phase frequency controlled motors. For ventilation systems in various premises.



Design

- The casing is made of high-quality plastic.
- Mounting junction box for wall flush mounting.
- IP40 ingress protection rating.

Control

- Switching on/off by the control knob.
- Smooth speed control from minimum to maximum value. Minimum speed is set by a variable resistor on the control panel.
- Several fans can be controlled from one unit provided that the total current consumption does not exceed the permissible controller current.
- High efficiency and control accuracy.

Protection

- Input circuit protected with a thermal fuse.
- Equipped with a transient filter.

Mounting

- Indoor wall flush mounting in a mounting box.
- Suitable for installation in standard electric junction boxes.

Options

- Mounting box **EDR-E** for wall surface mounting available upon separate order.

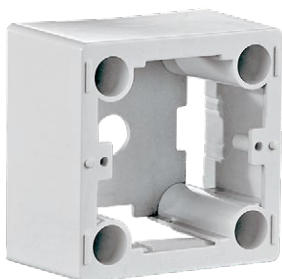

Technical data

Parameters	CDT E1.8
Voltage [V]	1 ~ 230
Frequency [Hz]	50/60
Rated current [A]	1.8
Overall dimensions WxHxD [mm]	80x80x63
Transported air temperature [°C]	+35
IP rating	IP40
Weight [g]	0.11

CDTE E1.8

Thyristor speed controller



Use

- For switching fans on/off and for speed control of single-phase frequency controlled motors. For ventilation systems in various premises.

Design

- Casing made of high-quality plastic.
- Surface box for mounting.
- IP40 ingress protection rating.

Control

- Switching on/off by control knob.
- Smooth speed control from minimum to maximum value. The minimum rotation speed is set by a variable resistor on the control panel.
- Several fans can be controlled from one unit provided that the total current consumption does not exceed the permissible controller current.
- Featured with high efficiency and control accuracy.

Protection

- Input circuit protected with a thermal fuse.
- Equipped with a transient filter.

Mounting

- Indoor wall mounting.

Technical data

Parameters	CDTE E1.8
Voltage [V]	1 ~ 230
Frequency [Hz]	50/60
Rated current [A]	1.8
Overall dimensions WxHxD [mm]	80x80x64
Transported air temperature [°C]	35
IP rating	IP40
Weight [kg]	0.11

Wiring diagram

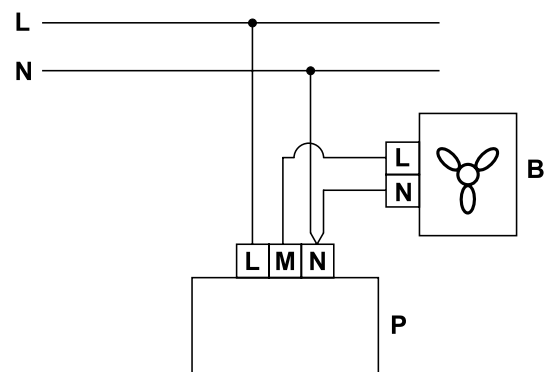

CDT E/0-10

Speed control for EC motors

Use

- For switching fans on/off and for speed control of EC motors with 0–10 V control voltage input.



Design

- Casing made of high-quality plastic.
- Mounting junction box for wall flush mounting.
- IP40 ingress protection rating.

Control

- Switching on/off by the control knob.
- Speed control from minimum to maximum value.
- Featured with high efficiency and control accuracy.

Mounting

- Indoor wall flush mounting in a mounting box.
- Suitable for installation in standard electric junction boxes.

Options

- Mounting box **EDR-E** for wall surface mounting available upon separate order.

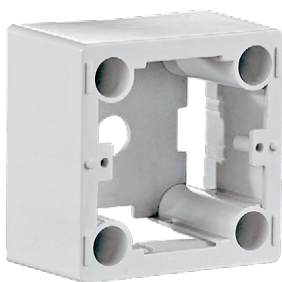

Technical data

Parameters	CDT E/0-10
Voltage [V]	10–48 DC
Control input [V]	0–10
Overall dimensions WxHxD [mm]	80x80x63
Transported air temperature [°C]	+35
IP rating	IP40
Weight [g]	0.11

Wiring diagram

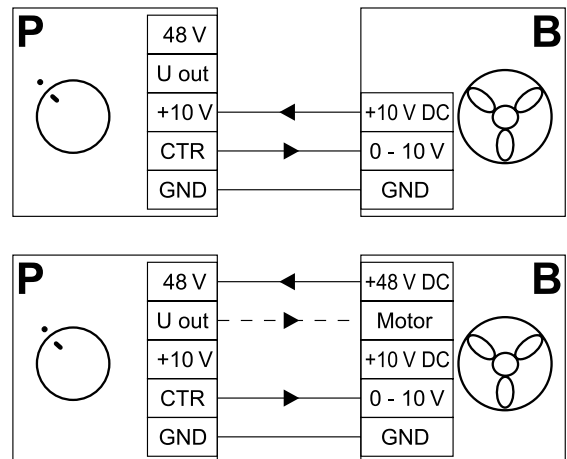

CDTE E/0-10

Speed controller for EC motors



Use

- For switching the fan on/off and for speed control of EC motors with 0–10 V control voltage input.

Design

- Casing made of high-quality plastic.
- Surface box for mounting.
- IP40 ingress protection rating.

Control

- Switching on/off by control knob.
- Speed control from minimum to maximum value.
- Featured with high efficiency and control accuracy.

Mounting

- Indoor wall mounting.

Wiring diagram

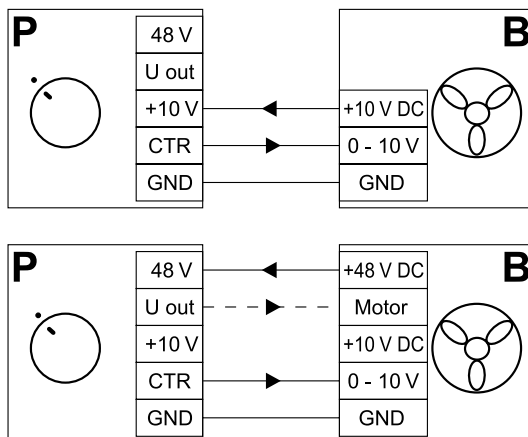

Technical data

Parameters	CDTE E/0-10
Voltage [V]	10–48 DC
Control input [V]	0–10
Overall dimensions WxHxD [mm]	80x80x63
Max. ambient temperature [°C]	+35
IP rating	IP40
Weight [kg]	0.12

CDPI-2 E5 CDPI-3 E5

Multi-speed switches

Use

- On/off switch and speed selection for multi-speed fans.



Design

- Casing made of high-quality plastic.
- The casing includes an ON/OFF button, speed regulator and an operation light.
- Wall flush mounting.
- IP40 ingress protection rating.

Mounting

- Designed for wall mounting in a flush mounting box.

Technical data

Parameters	CDPI-2 E5	CDPI-3 E5
Voltage [V]	1 ~ 230	1 ~ 230
Frequency [Hz]	50	50
Rated current [A]	5.0	5.0
Number of speeds	2	3
Overall dimensions WxHxD [mm]	162x80x70	162x80x70
Max. ambient temperature [°C]	+40	+40
IP rating	IP40	IP40
Weight [kg]	0.25	0.25

Wiring diagram

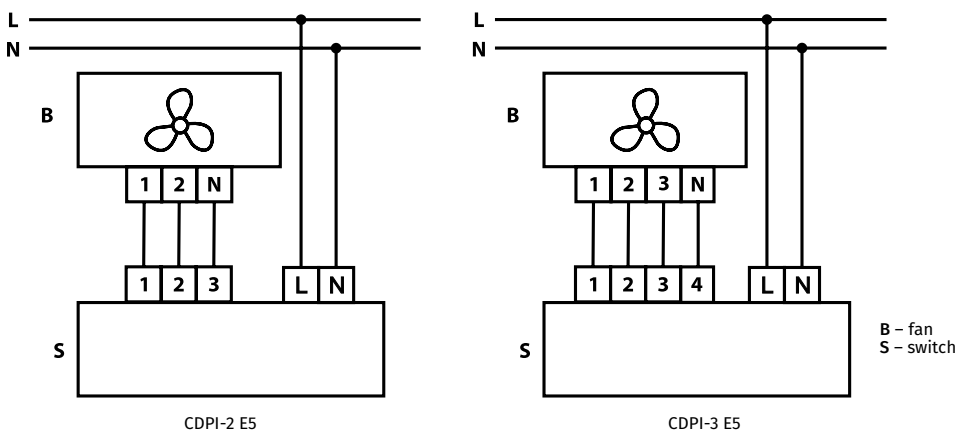

CDPE-2 E5 CDPE-3 E5

Multi-speed switches

Use

- On/off switch and speed selection for multi-speed fans.



Design

- Casing made of high-quality plastic.
- The casing includes an ON/OFF button, speed regulator and an operation light.
- Wall surface mounting.
- IP40 ingress protection rating.

Mounting

- Designed for wall surface mounting.

Technical data

Parameters	CDPE-2 E5	CDPE-3 E5
Voltage [V]	1 ~ 230	1 ~ 230
Frequency [Hz]	50	50
Rated current [A]	5.0	5.0
Number of speeds	2	3
Overall dimensions WxHxD [mm]	162x80x70	162x80x70
Max. ambient temperature [°C]	+40	+40
IP rating	IP40	IP40
Weight [kg]	0.25	0.25

Wiring diagram

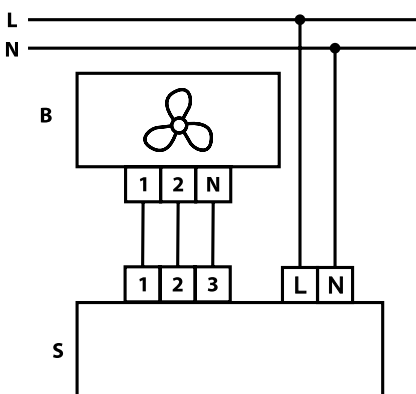

CDPE-2 E5

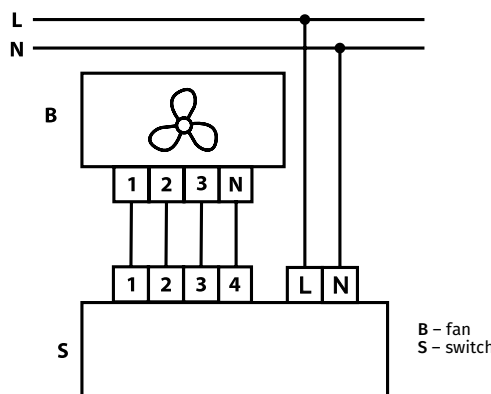

CDPE-3 E5

B – fan
S – switch

CDT1 E

Multi-speed switch

Use

- Applied in ventilation systems for speed switching ON/OFF and speed control of single phase power-controlled motors. Several fans can be controlled synchronously in case their total current does not exceed the maximum permissible value of the controller current.



Design and control

- The controller casing is made of plastic. The control knob is equipped with the pilot light. The controller is featured with high efficiency and control accuracy. Switching is effected by means of pressing the control knob. Regulating starts from the minimum to the maximum voltage value for the fan stable running. The minimum speed is set by means of the potentiometer at the PCB. The controller is equipped with extra 230 V terminal for connection and control of the external equipment.

Protection

- Input circuit of the speed controller has a thermal fuse for overload protection. The controller is fitted with a transient filter.

Mounting

- The universal design of the controller enables its mounting either on the wall or through the wall, suitable for installation into standard round electric junction boxes.

Wiring diagram

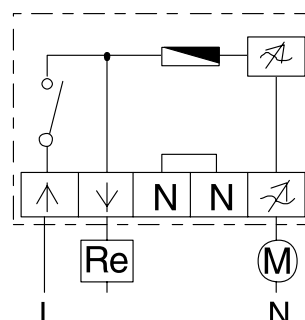
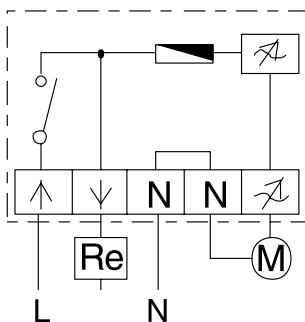

Technical data

Parameters	CDT1 E0.5	CDT1 E1.5	CDT1 E2.5	CDT1 E4.0
Voltage [V]	1 ~ 230	1 ~ 230	1 ~ 230	1 ~ 230
Frequency [Hz]	50	50	50	50
Minimum current [A]	0.1	0.15	0.25	0.4
Maximum current [A]	0.5	1.5	2.5	4.0
Overall dimensions WxHxD [mm]	82x82x65	82x82x65	82x82x65	82x82x65
Maximum ambient temperature [°C]	+35	+35	+35	+35
IP rating	IP44	IP44	IP44	IP44
Weight [kg]	0.23	0.24	0.29	0.36

CDT E CDTE E

Speed controllers

Use

- Applied in ventilation systems for speed switching ON/OFF and speed control of the single phase power-controlled motors. Several fans can be controlled synchronously in case their total current does not exceed the maximum permissible values for the controller current.



Design and control

- Controller has the plastic casing with the control knob, ON/OFF button and pilot light. The controller is featured with high efficiency and control accuracy. Regulation starts from the minimum fan stable running voltage value to the maximum one. The minimum rotation speed is set by means of the potentiometer on the PCB.

Protection

- Input circuit of the speed controller has a thermal fuse for overload protection. The controller is fitted with a transient filter.

Mounting

- The controller is designed for indoor wall mounting either on the wall (CDTE E) or through the wall (CDT E).

Wiring diagram

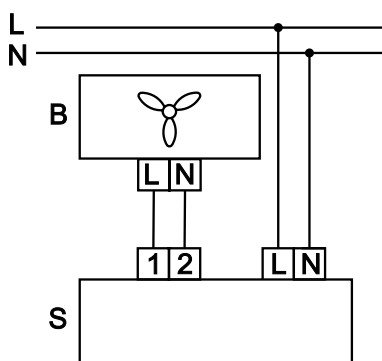

Technical data

Parameters	CDT(E) E1	CDT(E) E1.5	CDT(E) E2	CDT(E) E2.5
Voltage [V]	1 ~ 230	1 ~ 230	1 ~ 230	1 ~ 230
Frequency [Hz]	50	50	50	50
Rated current [A]	1.0	1.5	2.0	2.5
Overall dimensions WxHxD [mm]	162x80x70	162x80x70	162x80x70	162x80x70
Maximum ambient temperature [°C]	+40	+40	+40	+40
IP rating	IP44	IP44	IP44	IP44
Weight [kg]	0.3	0.3	0.3	0.3

TS E10

Room thermostat

Use

- For comfortable indoor temperature conditions and control of ventilation, heating and air conditioning systems.



Design

- Casing made of high-quality plastic.
- Temperature regulator on front panel and switch for operation mode selection on side panel.
- Supplied in casing for wall mounting.
- IP40 ingress protection rating.

Speed control

- Temperature regulation range from +10 up to +30 °C.
- The regulator has two operating patterns:
 - the contacts close when a temperature set point is reached and the fan turns on;
 - the contacts open when a temperature set point is reached and the fan turns off.

Mounting

- Indoor wall surface installation in mounting box.
- Recommended installation height is 1.5 m above the floor level.
- Do not install the regulator close to windows, heating or cooling equipment.

Wiring diagram

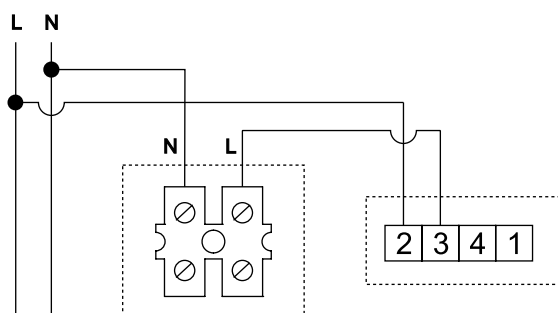

Fig. 1. The fan operates until the temperature threshold set by the thermostat is reached.

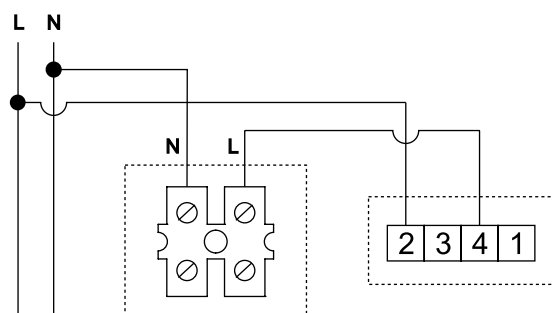

Fig. 2. The fan turns on when the temperature threshold set by the thermostat is reached.

Technical data

Parameters	TS E10
Voltage [V]	1 ~ 230
Frequency [Hz]	50/60
Rated current per Fig. 1 [A]	10 A
Rated current per Fig. 2 [A]	6 A
Overall dimensions WxHxD [mm]	84x84x35
Maximum ambient temperature [°C]	+40
IP rating	IP40
Hysteresis [°C]	0.5...1.0

MLC E2 / MLCD E2

Room temperature regulator

Use

- o Automatic or manual temperature control in ventilation and air conditioning systems installed in various premises.
- o Automatic regulation of heating/cooling rate.
- o Control of fans, fancoil dampers and air heating units equipped with three-speed 230 V fans.



Design

- o Casing made of high-quality plastic.
- o Equipped with a temperature sensor.
- o LED display with illumination and control knobs incorporated in front panel.
- o The display shows: set and current indoor temperature; operation mode for cooling, heating or auto; fan speed.
- o IP40 ingress protection rating.

Speed control

- o Control by control buttons on regulator casing or by remote control panel (MLCD E2 model).
- o Manual or automatic regulation of indoor temperature. Fan speed high/medium/low. On automatic mode fan speed is regulated by indoor temperature.
- o Automatic regulation of heating/cooling rate in "Night mode":
 - Cooling mode:** 30 min after activation of the night mode the set temperature for the room automatically starts rising by 1 °C per hour within two hours and stays at this level. After 8 hours the timer turns off and the set temperature resets to initial position.
 - Heating mode:** 30 min after activation of the night mode the set temperature for the room automatically starts dropping by 1 °C per hour within three hours and stays at this level. After 8 hours the timer turns off and the set temperature resets to initial position.
- o The set control functions are saved when the thermal regulator is switched off.

Mounting

- o Indoor installation.
- o Recommended installation height is 1.5 m above the floor level.
- o Do not install the regulator close to windows, heating or cooling equipment.

Modifications and options

- o Model **MLCD E2**: the regulator is equipped with a remote control panel.

Technical data

Parameters	MLC E2	MLCD E2
Voltage [V]	1 ~ 230	1 ~ 230
Frequency [Hz]	50	50
Rated current [A]	2.0	2.0
Number of speeds	3	3
Temperature regulating range. °C	+10...+30	+10...+30
Overall dimensions WxHxD [mm]	88x88x51	88x88x51
Maximum ambient temperature [°C]	+40	+40
IP rating	IP40	IP40
Remote control panel	no	yes

Wiring diagram

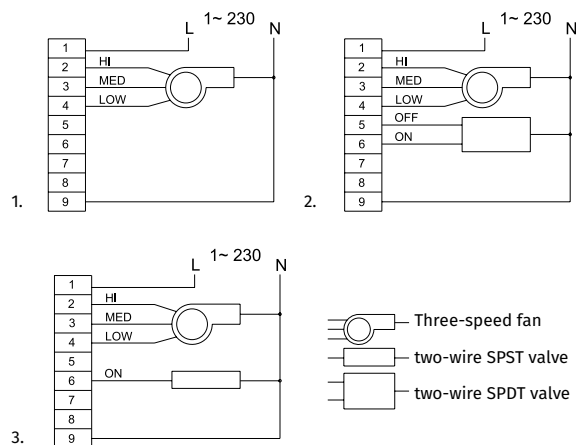

1. Ventilation with heating and cooling
2. Ventilation with heating and cooling three-wire system of SPDT valves
3. Ventilation with heating and cooling two-wire SPDT valve system

CD-1 / CD-2

CO₂ sensors

Use

- Indoor carbon dioxide concentration measurement.
- Air flow control depending on CO₂ concentration.
- Efficient energy saving device.



Design

- The sensor has two separate outputs, a normally opened dry relay contact and an analogue output 0–10 V that is adjustable for 2–10 V/ 0–20 mA/4–20 mA. The relay output is used to turn the fan on/off depending on indoor CO₂ concentration and the analogue output is used for smooth fan speed control for a fan with EC motor or a fan with extra speed controller with 0–10 V input. In case of smooth fan speed control the fan speed varies proportionally to carbon dioxide emissions. Due to the relay and analogue outputs the sensor is compatible with any ventilation system. The self-calibration system ensures reliable sensor operation during the sensor service life.

Modifications

- CD-1:** integrated LED lights for indication of CO₂ concentration and a touch button for operation mode switching (mode 1: on, mode 2: off, mode 3: operation according to CO₂ concentration). The button is used to turn the fan on or turn it off when CO₂-based ventilation is not required.
- CD-2:** no integrated LED-lights and no touch button. This model is recommended for premises requiring permanent ventilation as school classes and other public premises.

Mounting and power supply

- Wall surface mounting.
- 24 VAC low current power supply.
- The sensor has a socket for AT power unit offered as an accessory (**AT-220/25** or **AT-120/25** models).



Technical data

Parameters	Value
Power supply / Consumption	24 VAC (50/60 Hz ± 10 %), 24 VDC/1.6 W Max
Gas sensing element	Non-dispersive infrared detector (NDIR) with self-calibration system
CO₂-measuring range	0–2.000 ppm (parts per million)
Accuracy at 25 °C, 2.000 ppm	±30 ppm + 3 % of reading
Response time	max. 2 min
Warm up time for each turning-on	2 hours (first time), 2 minutes (operation)
Analogue output	0–10 VDC (default), 4–20 mA selectable by jumpers
On/Off output	1X2A switch load Four set points selectable by jumpers
6 LED lights for CO₂ concentration indication (for CD-1 model)	1st green indicator lights when CO ₂ concentration is below 600 ppm 1st and 2nd green indicators light when CO ₂ concentration is 600–800 ppm 1st yellow indicator lights when CO ₂ concentration is 800–1200 ppm 1st and 2nd yellow indicators light when CO ₂ concentration is 1200–1400 ppm 1st red indicator lights when CO ₂ concentration is 1400–1600 ppm 1st and 2nd red indicators light when CO ₂ concentration is above 1600 ppm
Operating conditions / Storage regulations	0...+50 °C; 0–95 % RH non condensing/0...+50 °C
Weight/Overall dimensions WxHxD [mm]	0.120 kg/80 mm x 100 mm x 30 mm

Wiring diagram

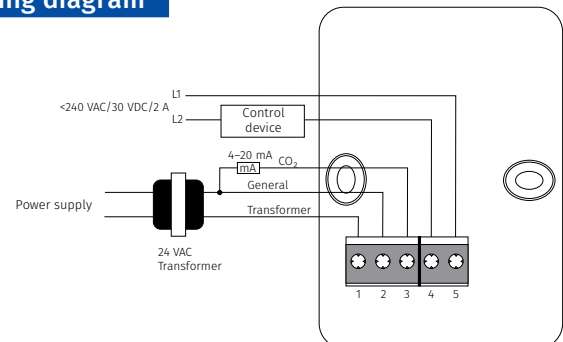

HR-S

Electro-mechanical humidistat



Use

- The humidistat is designed for controlling humidification and/or dehumidification in ventilation, air conditioning and heating systems.
- Can also be used to alarm when the humidity exceeds or falls below a pre-set level.

Design

- The single-stage humidistat **HR-S** uses a synthetic element as sensor medium. The synthetic element stretches as the humidity increases and shrinks as the humidity decreases.

Mounting

- The humidistat is designed for indoor mounting on the wall surface.

Wiring diagram

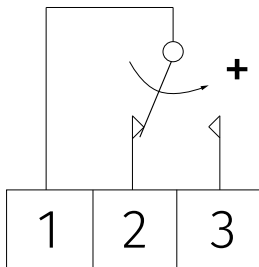

Humidification
Dehumidification

Closing contact between terminals 1 and 2
Closing contact between terminals 1 and 3

Technical data

Parameters	HR-S
Switch contact	250 V AC, 5 A
Moisture [%]	20–90
Casing material	Polycarbonate
Temperature range [°C]	0...+40
Mounting	Wall surface mounting
IP rating	IP30
Overall dimensions WxHxD [mm]	86x86x30

DRWQ40200

CO₂ sensor

Use

- Self-calibrating sensor with microprocessor control for measuring carbon dioxide content in the air within the range from 0 to 2.000 million⁻¹ (parts per million).



Design

- DRWQ40200** CO₂ sensor has 2 analogue outputs: 0–10 V and 4–20 mA. An analogue output provides for stepless fan speed control (requires an EC motor fan or a frequency drive).
- With stepless control the fan speed is changed in proportion to carbon dioxide concentration changes. The CO₂ content in the air is measured by means of a non-dispersive infrared analyser (NDIR).

Mounting

- The sensor is mounted onto a wall or a mounting box inside the serviced space. The unit is powered from a 24 V AC/DC low-current electric mains.

Technical data

Parameters	Values
Power source	24 V AC/DC
Gas analyser	optical (NDIR)
CO ₂ measurement range	0–2.000 million (parts per million) of CO ₂
CO ₂ output signal	0–10 V
CO ₂ measurement precision	± 30 million (parts per million), ± 5% of maximum value
Operating conditions	0...+50 °C; 10–90 % relative humidity without condensate
Protection class	IP55
Overall dimensions WxHxD [mm]	95x97x30

DPWC11200

Humidity and temperature sensor

Use

- o The **DPWC** sensor is intended for temperature, humidification and/or dehumidification control in ventilation, air conditioning and heating systems.



Design

- o The **DPWC11200** humidity and temperature sensor has 2 analogue outputs: 0–10 V and 4–20 mA. An analogue output provides for stepless fan speed control (requires an EC motor fan).
- o With stepless control the fan speed is changed in proportion to the humidity and temperature level. Being equipped with both relay and analogue outputs the sensor is compatible with most every existing ventilation systems.

Mounting

- o The sensor is mounted onto a wall in the serviced space. The unit is powered from a 24 V AC/DC low-current electric mains.

Technical data

Parameters	Values
Power source	8–30 V DC / 12–24 V AC
Analogue outputs	0–10 V and 4–20 mA
Temperature measurement precision	±1.2 °C
Humidity measurement precision	±3 % RH
Operating conditions	-10...+60 °C; 10–90 % humidity without condensate
Protection class	IP30
Overall dimensions WxHxD [mm]	127x80x30 mm

DPWQ30600

VOC sensor

Use

- Self-calibrating processor-controlled VOC sensor provides air quality measurement.
- The device is used for quantitative assessment of indoor air saturation with contaminants (e.g. cigarette smoke, expired air, and solvent and detergent vapours).
- Enables setting the sensitivity level relative to an expected maximum air pollution level.
- Enables on-demand ventilation which results in considerable energy savings as air is exchanged only upon reaching the pre-set level of air pollution.



Design

- DPWQ30600** VOC sensor has 2 analogue outputs: 0–10 V and 4–20 mA. An analogue output provides for stepless fan speed control (requires an EC motor fan or a frequency drive).
- With stepless control the fan speed is changed in proportion to air quality changes.

Mounting

- The sensor is mounted onto a wall or a mounting box inside the serviced space. The unit is powered from a 24 V AC/DC low-current electric mains.

Technical data

Parameters	Values
Power source	24 V AC/DC
Gas analyser	VOC sensor
Measurement range	0–100 % air quality
Output signal	0–10 V
Measurement precision	±20 %
Operating conditions	0...+50 °C; 10–90 % relative humidity without condensate
Protection class	IP30
Dimensions WxHxD [mm]	79x81x26 mm

TE / TI 1.5

Timers

HSE / HSI 1.5 LSE / LSI 1.5 IRSE / IRSI 1.5

Sensors



RUN-OUT TIMER TE / TI 1.5

Use

- o Automatic regulation of residential fans.
- o Keeping the fan running within pre-set time period adjustable between 2 and 30 min after pressing the turn-off button. The run-out timer switches the fan off after the set time expires.
- o Setting of ventilation cycle for bathrooms, WC, kitchens and other residential premises.

Design and mounting

- o Casing made of high-quality plastic.
- o Indoor installation.
- o Model **TE 1.5**: supplied in casing for wall surface mounting.
- o Model **TI 1.5**: supplied in casing for flush mounting.

HUMIDITY SENSOR WITH TIMER HSE / HSI 1.5

Use

- o Automatic regulation of residential fans.
- o Setting of individually adjustable indoor humidity threshold value. Automatically switches the fan on if humidity level in the room exceeds pre-set value.
- o Bathrooms, shower rooms, kitchens, water pools and other humid premises.

Design and mounting

- o The casing is made of high-quality plastic.
- o Indoor installation.
- o Model **HSE 1.5**: supplied in casing for wall surface mounting.
- o Model **HSI 1.5**: supplied in casing for flush mounting.

Wiring diagram

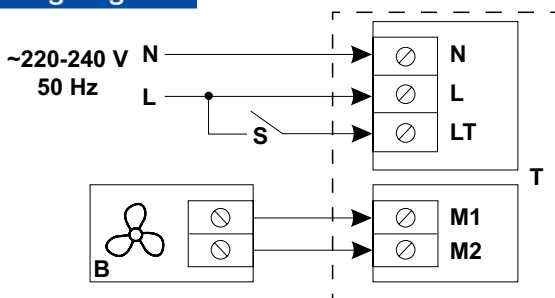

B: fan;
S: external switch;
T: sensor.

PHOTO SENSOR WITH INTEGRATED TIMER LSE / LSI 1.5

Use

- o Automatic regulation of residential fans.
- o Bathrooms, WC, kitchens and other periodically occupied premises.
- o The integrated photo sensor responds to illumination level changes in the room and switches the fan automatically on or off.
- o When the light is turned off the fan continues operating from 2 to 30 min according to timer settings and then is switched off.

Design and mounting

- o Casing made of high-quality plastic.
- o Indoor installation.
- o Model **LSE 1.5**: supplied in casing for wall surface mounting.
- o Model **LSI 1.5**: supplied in casing for flush mounting.

MOTION SENSOR WITH TIMER IRSE / IRSI 1.5

Use

- o Automatic regulation of residential fans.
- o Bathrooms, WC, kitchens and other periodically occupied premises.
- o The integrated infra-red sensor responds to motion registered in the sensitivity area and automatically switches the fan on.
- o The fan is turned off from 2 to 30 min after no motion is registered in the sensitivity area. The run-out time is pre-set.

Design and mounting

- o Casing made of high-quality plastic.
- o Indoor installation.
- o Model **IRSE 1.5**: supplied in casing for wall surface mounting.
- o Model **IRSI 1.5**: supplied in casing for flush mounting.

Technical data

Parameters	TE / TI 1.5; HSE / HSI 1.5; LSE / LSI 1.5; IRSE / IRSI 1.5
Voltage [V]	1 ~ 220-240
Frequency [Hz]	50
Max. output power. [VA]	330
Max. load current [A]	1.5
Overall dimensions WxHxD [mm]	162x80x70
Timer operating conditions [°C]	+1...+45
IP rating	IP30
Weight [kg]	0.4

BELIMO CM230/CM24

Electric actuators

Use

- For controlling air dampers with cross section up to 0.4 m² installed in various ventilation and air conditioning systems.



Design

- The electric actuator is provided with a 2 Nm actuating torque and an overload protection.
- The actuator is installed directly on the air damper shaft.
- The angle of rotation is adjusted by mechanical end stops.

Control

- The air flow control damper can be controlled by means of the three-point or open-close controlling.

Wiring diagram

Open-Close controlling

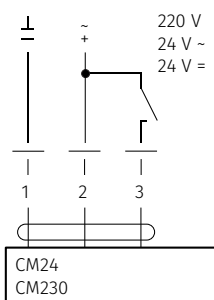

3 point controlling

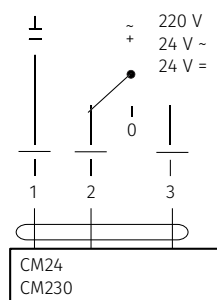

Technical data

Parameters	CM24	CM230
Voltage	24 V ~ 50/60 Hz, 24 V =	230 V ~ 50/60 Hz
Nominal voltage range [V]	19.2...28.8 ~ 19.2...28.8 =	85...265 ~
Rated power [VA]	1	2
Power consumption in operation / at rest [W]	0.5 / 0.5	1 / 1
Connecting cable	1 m long, 3 x 0.75 mm ²	1 m long, 3 x 0.75 mm ²
Positioning accuracy	± 5 %	± 5 %
Direction of rotation	determined by terminal connection	
Torque [Nm]	2 (at nominal voltage)	
Angle of rotation: - no end stop - with an end stop	endless fixed 315° / adjustable 0...287.5° in 2.5° increments	
Swing time	75 s / 90°	75 s / 90°
Position indication	mechanical	mechanical
IP rating	IP54 at any mounting position	
Electrical protection class	III low voltage II totally insulated	
Operation temperature [°C]	-30...+50	-30...+50
Storage temperature [°C]	-40...+80	-40...+80
Ambient humidity	95 %, no condensation	
Noise level [dBA]	35	35
Maintenance	not required	not required
Weight [kg]	0.13	0.13

Overall dimensions [mm]

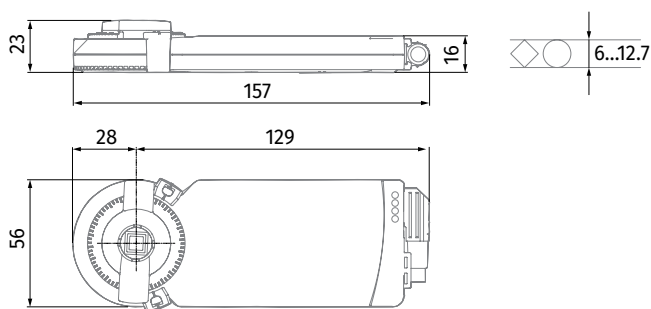

BELIMO LM230A/LM24A

Electric actuator



Use

- For controlling air dampers with cross section up to 1 m² installed in various ventilation and air conditioning systems.

Design

- The electric actuator is provided with a 5 Nm actuating torque and an overload protection.
- The actuator is installed directly on the air damper shaft.
- The angle of rotation is adjusted by mechanical end stops.

Speed control

- The air flow control damper can be controlled by means of the three-point or open-close controlling.

Wiring diagram

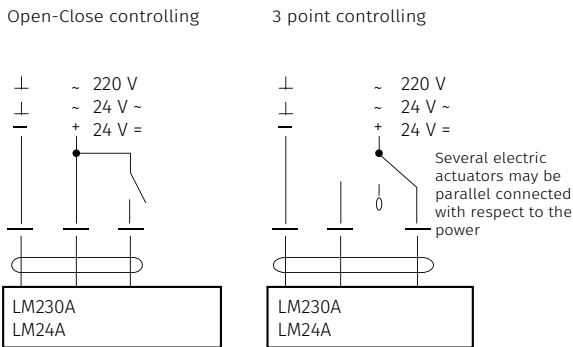

Technical data

Parameters	LM24A	LM230A
Voltage	24 V ~ 50/60 Hz, 24 V=	230 V ~ 50/60 Hz
Nominal voltage range [V]	19.2...28.8 ~ 19.2...28.8 =	85...265 ~
Rated power [VA]	2	4
Power consumption [W]	1	1.5
Feedback potentiometer	integrated 5 kOhm ± 5 %	
Connecting cable	1 m long, 3 x 0.75 mm ²	
Direction of rotation	selected by 0/1 switch positioning	
Mechanical control	self-resetting button	
Torque [Nm]	5 (at nominal voltage)	
Angle of rotation:	max. 95°, adjustable with mechanical end stops	
Swing time	150 s	
Position indication	mechanical	
IP rating	IP54 at any mounting position	
Electrical protection class	III low voltage II totally insulated	
Operation temperature [°C]	-30...+50	
Storage temperature [°C]	-40...+80	
Ambient humidity	95 %, no condensation	
Noise level [dBA]	35	
Maintenance	not required	
Weight [kg]	0.6	

Overall dimensions [mm]

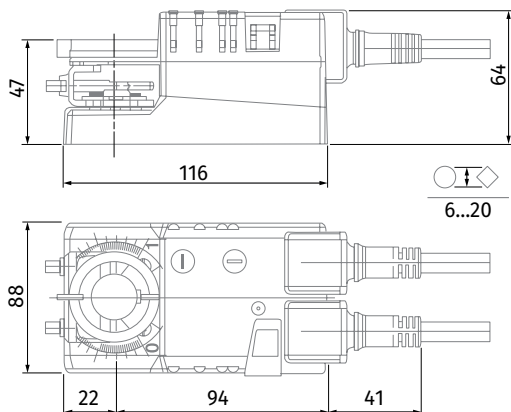

BELIMO TF230/TF24

Electric actuators

Use

- For controlling air dampers with cross section up to 0.4 m² installed in various ventilation and air conditioning systems and performing protection functions.



Design

- The electric actuator is provided with a 2 Nm actuating torque and an overload protection.
- The actuator is installed directly on the air damper shaft.
- The actuator is equipped with a return spring, which moves the damper to its operating position while tensioning the return spring at the same time. In case of power supply cut-off, the damper moves back to its safe position by the spring energy.
- The angle of rotation is adjusted by mechanical end stops.

Wiring diagram

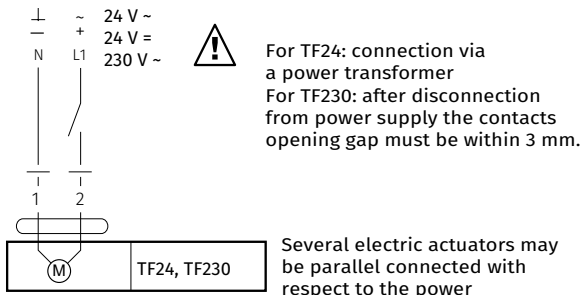

Technical data

Parameters	TF24	TF230
Voltage	24 V ~ 50/60 Hz, 24 V=	230 V ~ 50/60 Hz
Nominal voltage range [V]	19.2...28.8 ~ 21.6...28.8 V=	85...265 ~
Rated power [VA]	4 (max. 1.58 A at t = 5 ms)	4 (max. 1.150 mA at t = 10 ms)
Power consumption in operation / at rest [W]	2 / 1.3	2 / 1.3
Connecting cable	1 m long, 2 x 0.75 mm ²	1 m long, 2 x 0.75 mm ²
Direction of rotation	determined by L/R positioning	
Torque (motor / spring) [Nm]	2 (at nominal voltage) / 2	
Angle of rotation:	max. 95°, adjustable 37...100 % with a mechanical end stop	
Swing time (motor / spring) [s]	40...75 (0...2 Nm) / < 25 bei -20...+50 °C	
Service life	60 000 switching operations	
IP rating	IP42	IP42
Electrical protection class	III low voltage II totally insulated	III low voltage II totally insulated
Operation temperature [°C]	-30...+50	
Storage temperature [°C]	-40...+80	
Ambient humidity	95 %, no condensation	
Noise level (motor/ spring) [dBA]	50 / ≈ 62	50 / ≈ 62
Maintenance	not required	
Weight [kg]	0.6	0.6

Overall dimensions [mm]

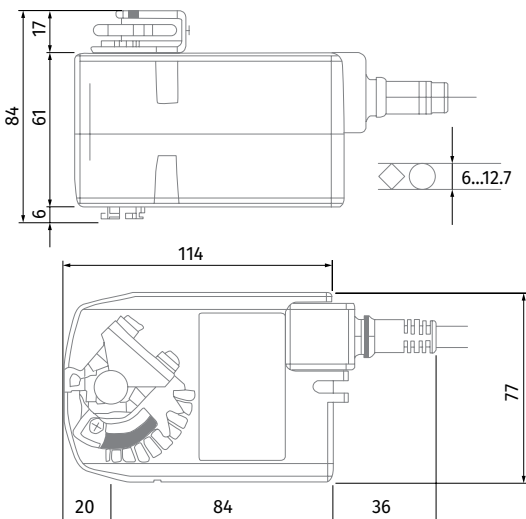

BELIMO LF230/LF24

Electric actuators



Use

- For controlling air dampers with cross section up to 0.8 m² installed in various ventilation and air conditioning systems and performing protection functions.

Design

- The electric actuator is provided with a 4 Nm actuating torque and an overload protection.
- The actuator is installed directly on the air damper shaft.
- The actuator is equipped with a return spring, which moves the damper to its operating position while tensioning the return spring at the same time. In case of power supply cut-off, the damper moves back to its safe position by the spring energy.
- The angle of rotation is adjusted by mechanical end stops.

Wiring diagram

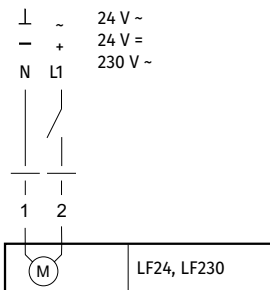

Warning!
For LF24: connection via a power transformer

For LF230: after disconnection from power supply the contacts opening gap must be within 3 mm

Several electric actuators may be parallel connected with respect to the power

Overall dimensions [mm]

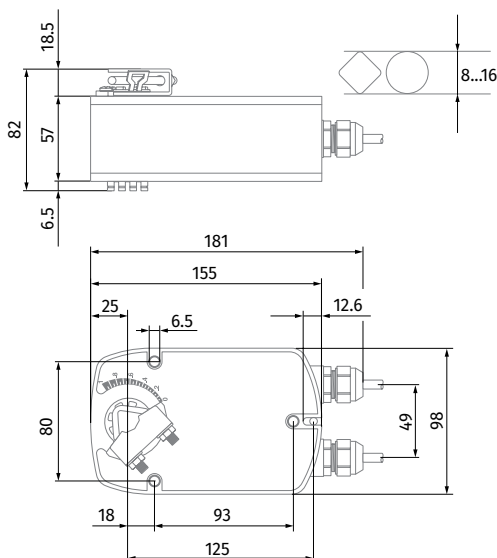

Technical data

Parameters	LF24	LF230
Voltage	24 V ~ 50/60 Hz, 24 V=	230 V ~ 50/60 Hz
Nominal voltage range [V]	19.2...28.8 ~ 21.6...28.8 V=	198...264 ~
Rated power [VA]	7 (max. I 5.8 A at t = 5 ms)	7 (max. I 150 mA at t = 10 ms)
Power consumption in operation / at rest [W]	5 / 2.5	5 / 3
Connecting cable	1 m long, 2 x 0.75 mm ²	1 m long, 2 x 0.75 mm ²
Direction of rotation	determined by L/R positioning	
Torque (motor / spring) [Nm]	4 (at nominal voltage) / 4	
Angle of rotation	max. 95°, adjustable 37...100 % with a mechanical end stop	
Swing time (motor / spring) [s]	40...75 (0...4 Nm) / ~ 20 at -20...+50 °C	
Service life	60 000 switching operations	
IP rating	IP54 (installation with cable downwards)	
Electrical protection class	III low voltage II totally insulated	III low voltage II totally insulated
Operation temperature [°C]	-30...+50	
Storage temperature [°C]	-40...+80	
Ambient humidity	95 %, no condensation	
Noise level (motor/ spring) [dBA]	50 / ≈ 62	
Maintenance	not required	
Weight [kg]	1.4	

DWP2

Swirl diffusers

Features

- A swirl diffuser balances air parameters throughout the entire space of the treated room by forming vortex air flow.



Design

- The units are made from steel and powder-coated.
- Angled blades provide high ejector capability.
- Specially designed casing with additional side slots for horizontal discharge.
- Ceiling-mounted with direct air duct connection.

Overall dimensions

Model	Diameter d [mm]	Height H [mm]	Weight [kg]
DWP2 100	100	150	0.209
DWP2 125	125	150	0.267
DWP2 150	150	150	0.323
DWP2 160	150	150	0.341
DWP2 200	200	150	0.439
DWP2 250	250	150	0.567
DWP2 315	315	150	0.767

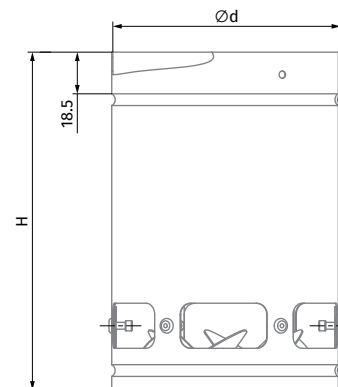

Effective flow area and recommended speeds

Model	EFA [m ²]	V min [m/s]	V max [m/s]	Q min [m ³ /h]	Q max [m ³ /h]
DWP2 100	0.0086	2	7	62	217
DWP2 125	0.0118	2	6	85	255
DWP2 150	0.0177	2	6	127	382
DWP2 160	0.0222	2	6	160	480
DWP2 200	0.0358	3	8	387	1031
DWP2 250	0.058	2	6	418	1253
DWP2 315	0.083	2	6	598	1793

Technical data

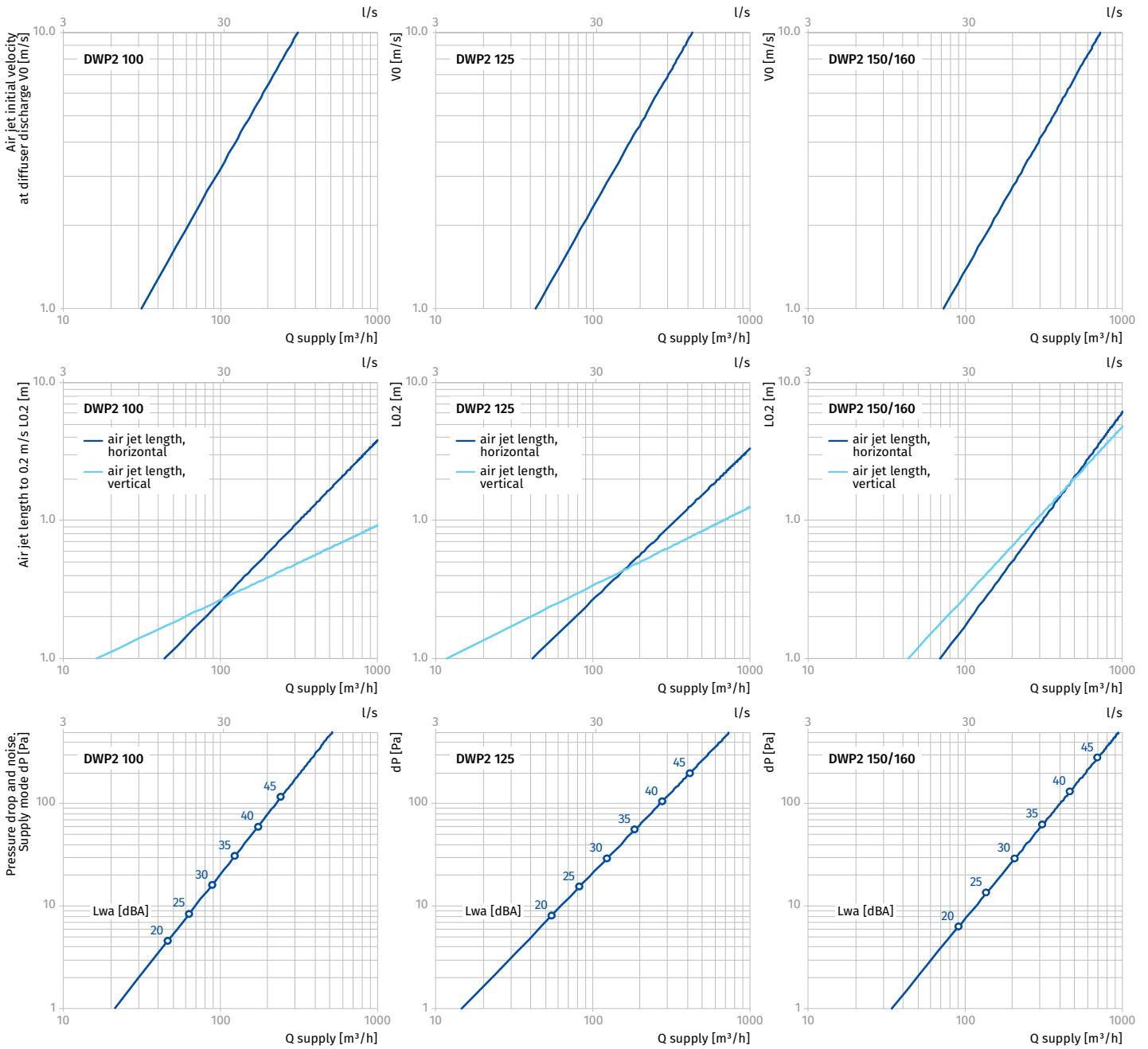

The quoted values are true for a diffuser directly connected to an air duct.

Technical data

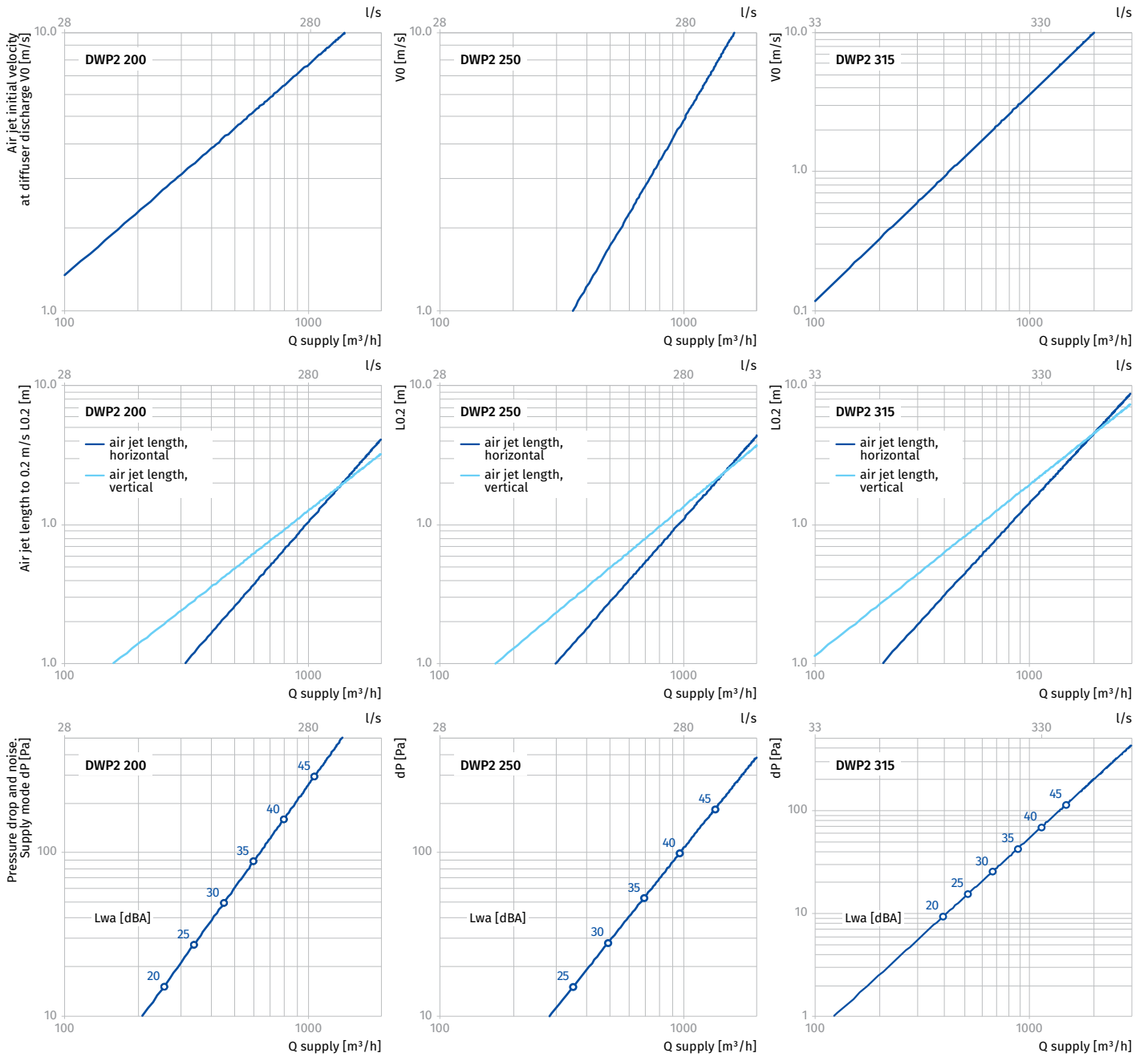

The quoted values are true for a diffuser directly connected to an air duct.

Technical data

AIR JET DISTRIBUTION GEOMETRY

- The diffuser is shaped to create a bi-directional air jet: the side slots ensure horizontal air discharge while the internal blades fixed at 30-35° (depending on the model) form a vortex air jet in the vertical plane.
- $I_{0.2 \text{ hor.}}$ is the maximum range of the air jet in the horizontal plane to the point at which the air jet velocity is 0.2 m/s.
- $I_{0.2 \text{ vert.}}$ is the maximum range of the air jet in the vertical plane to the point at which the air jet velocity is 0.2 m/s.

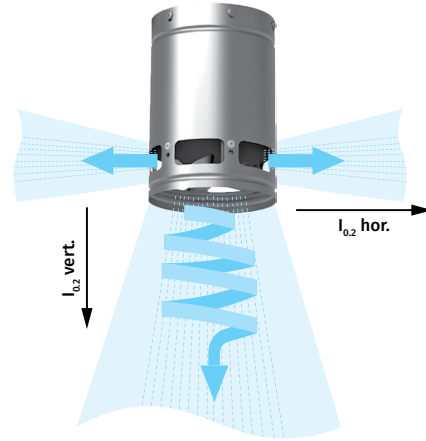

Noise characteristics

- Noise characteristics are calculated using the indices given below.

OCTAVE FREQUENCY BAND ADJUSTMENT INDEX FOR SOUND POWER LEVELS

Kok supply mode	Octave frequency band [Hz]							
	63	125	250	500	1000	2000	4000	8000
DWP2 100	16	12	8	5	-2	-5	-14	-20
DWP2 125	15	13	9	3	-1	-6	-13	-20
DWP2 150/160	14	14	9	-1	-2	-4	-9	-21
DWP2 200	15	12	7	3	-4	-7	-8	-18
DWP2 250	18	12	7	3	-3	-8	-10	-19
DWP2 315	18	10	9	-1	-4	-6	-10	-16

INDEX FOR DUCT SOUND POWER ABSORPTION BY DIFFUSER

dL supply mode [dB]	Octave frequency band [Hz]							
	63	125	250	500	1000	2000	4000	8000
DWP2 100	3	3	2	5	3	4	2	1
DWP2 125	3	4	3	5	4	2	2	2
DWP2 150/160	4	3	4	6	3	3	4	3
DWP2 200	6	4	4	6	4	4	3	3
DWP2 250	5	4	5	7	5	5	4	2
DWP2 315	7	6	5	7	4	6	5	4

The quoted values are true for a diffuser directly connected to an air duct.

Non-isometric air flows

- The value given in the catalogue are true for isothermal jets – i.e. when the jet temperature equals the temperature in the room.
- Any difference in the jet temperature and room temperature affects the jet geometry.
- During cold air supply the jet is deflected downwards with a reduction in length.
- During warm air supply the jet is deflected upwards with an increase in length.

$$I'_{0.2} = I_{0.2} * KI_{0.2}$$

$KI_{0.2 \text{ hor.}}$ is the index of horizontal jet length change

$KI_{0.2 \text{ vert.}}$ is the index of vertical jet length change

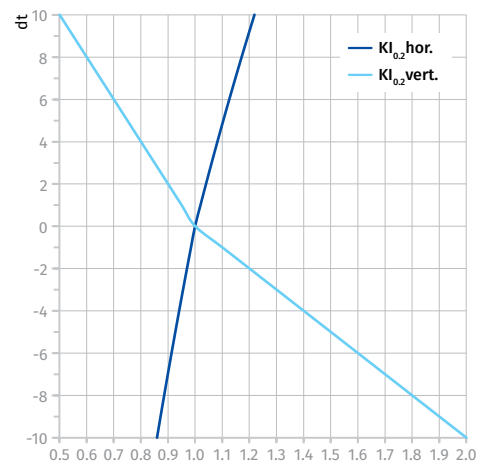

dt is the difference between the supply air and indoor air



Blauberg Ventilatoren GmbH
Aidenbachstr. 52
D-81379 Munich

info@blaubergventilatoren.de
www.blaubergventilatoren.de

Technical changes reserved.
Illustrations and texts are non-binding.

02/2021