

VENTO ERGO A85-1 PRO V.3

HEAT RECOVERY SINGLE-ROOM UNITS

Features

- Arrangement of efficient energy-saving supply and exhaust single-room ventilation in flats, houses, cottages, social and commercial premises.
- Heat recovery minimises ventilation heat losses.
- Humidity balance and controllable air exchange create individually set micro-climate.
- Coordinated network based on several integrated single-room ventilation units with central control.



Air flow:
up to 85 m³/h
24 l/s



Heat recovery efficiency:
up to 90 %



Power: from 4.74 W
SFP: from 0.80 W/l/s



Noise level:
from 19 dBA



Design

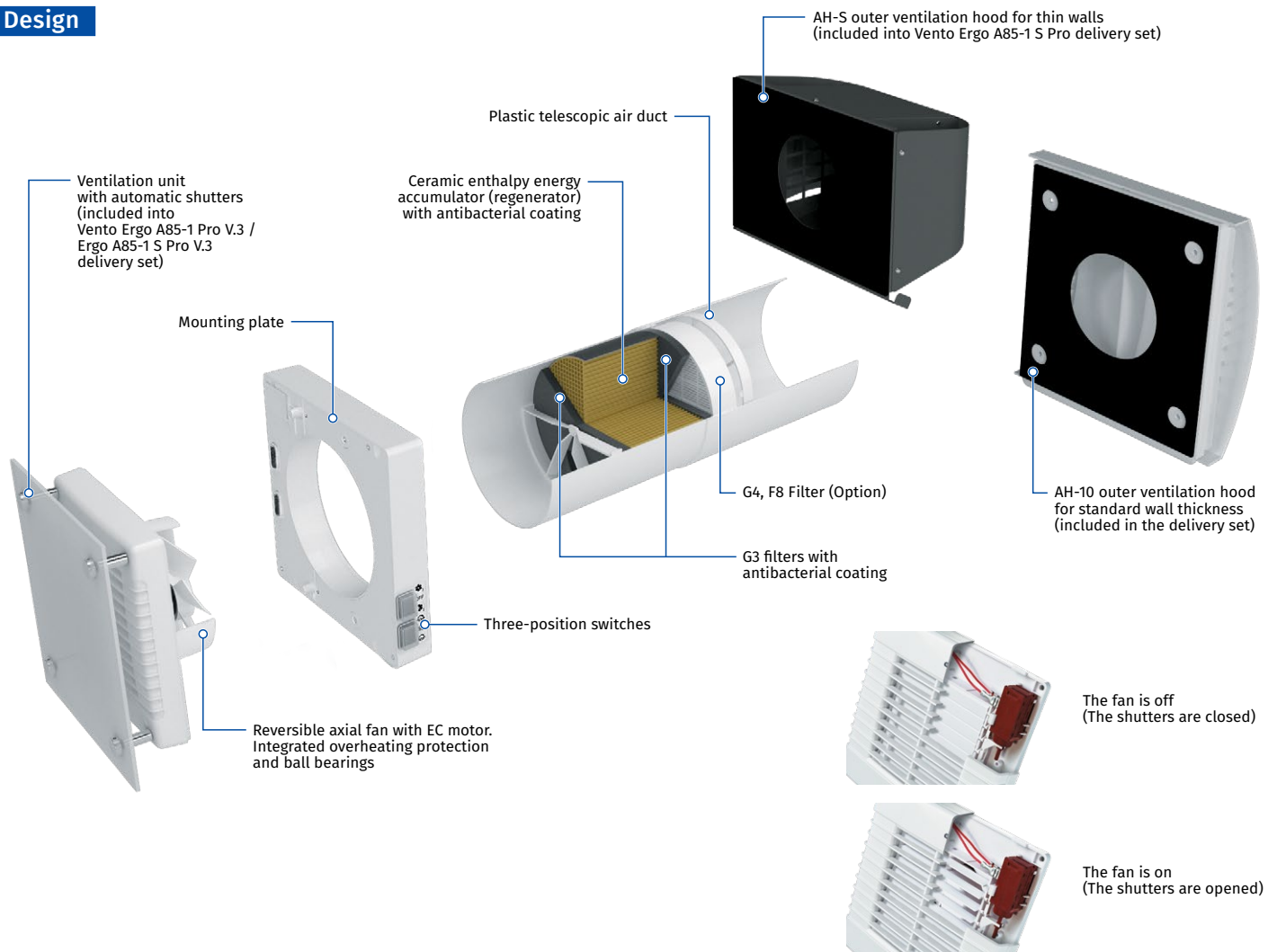

Designation key

Model	Air duct	Rated air flow [m ³ /h]	Front panel	Hood type	Control	Version
Vento Ergo	A: round air duct	85	- 1: flat front panel	_: white plastic hood AH-10 white 100 (for standard walls) S: AH-S chrome 150 metal hood for thin walls	Pro: three-position switches and remote control	V.3: plastic mounting plate, two boards, fuse on board

VENTO ERGO A85-1 PRO V.3

HEAT RECOVERY SINGLE-ROOM UNITS

Heat and humidity regeneration

- High-tech ceramic energy accumulator with heat recovery up to 90 %.
- Due to its cellular structure it has a larger heat transfer area surface and high efficiency.

UNIT OPERATING LOGIC IN WINTER PERIOD

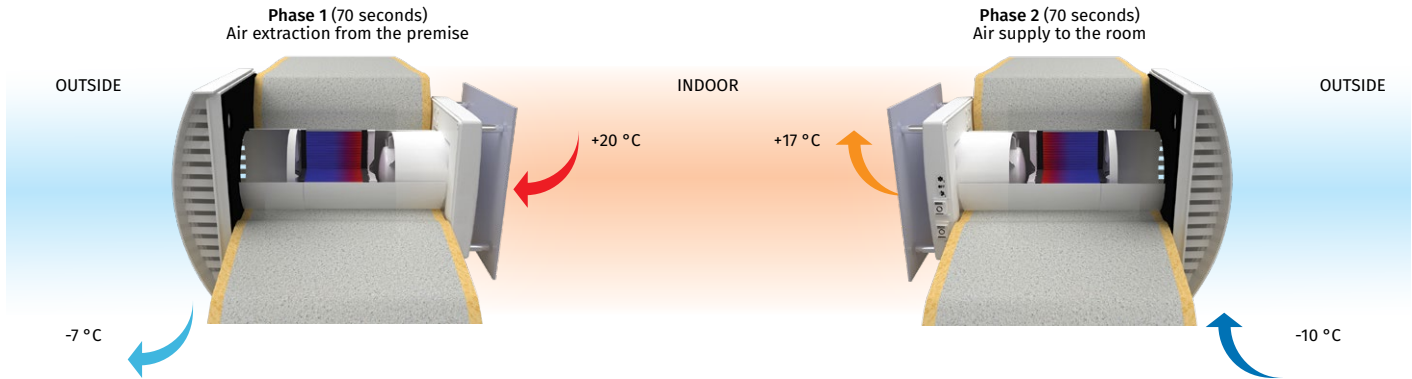

- Warm stale air is extracted from the premise, flows through the ceramic regenerator and transfers a part of the accumulated heat and moisture to it.
- In 70 seconds, after heating of the ceramic regenerator, the unit switches to the supply mode.
- Clean cold intake air flows through the regenerator and absorbs accumulated heat and humidity.
- In 70 seconds, after cooling of the ceramic regenerator, the unit is switched to the extract air mode.

Control

- The unit operation mode control is performed by means of manual three-position switches located on the unit casing or using the remote controller.
- The unit is equipped with a humidity sensor for indoor humidity control and regulation.
- Connection of the units into one ventilation system provide balanced ventilation and central control.
- Remote control and operation mode selection:

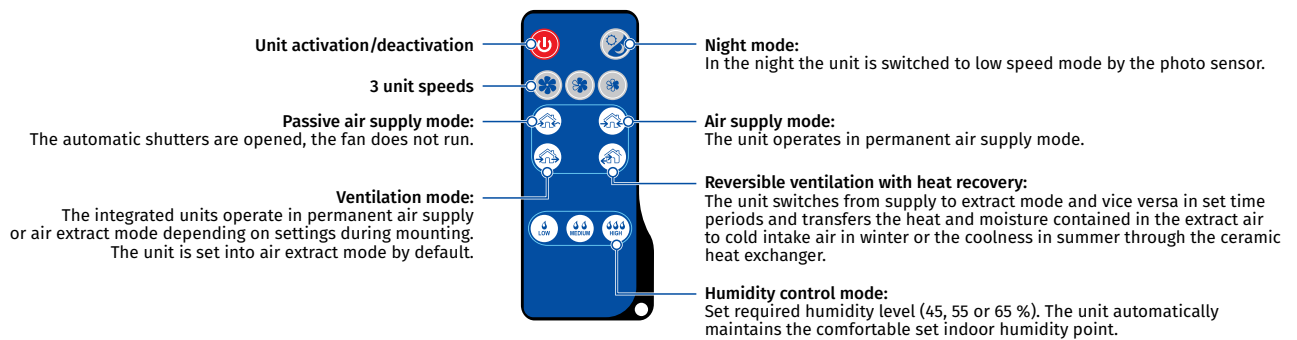
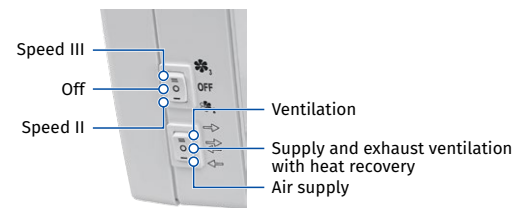

- Connection of several units in series enables their synchronous control by the first unit. The signal from the remote control is received by the first unit only.

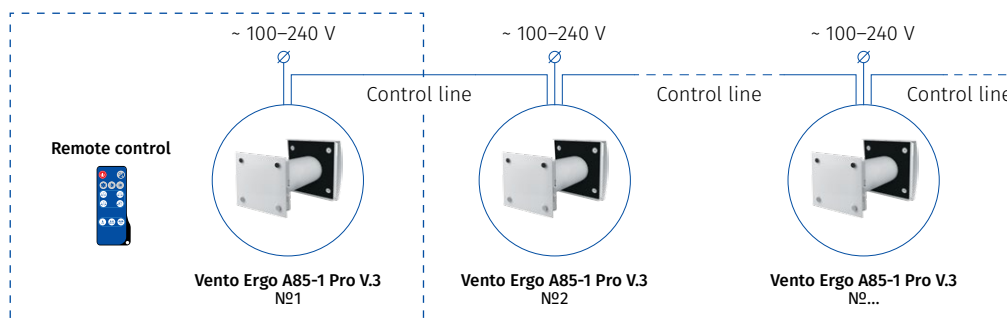

VENTO ERGO A85-1 PRO V.3

HEAT RECOVERY SINGLE-ROOM UNITS

Mounting

- The unit is designed for external through-the-wall installation inside a prepared round hole in the outer wall of the building.
- The best ventilation solution is pairwise installation of reverse phase connected units. Some units supply fresh air to the room and the other units extract stale air from the room. This allows to arrange the most efficient balanced ventilation.
- In case of brand new construction the units are mounted in two stages:
 - **pre-installation** at the stage of the indoor finishing and outer decorative wall finishing. It includes installation of the telescopic air ducts, outer ventilation hood and laying out of electric cables.
 - **final mounting** before commissioning of a house. It includes installation of the regenerator, the filters, connection of the ventilation unit.
- If mounting of the ventilation hood on the outer wall is undesirable it may be flush mounted and the external grille may be inserted into the outer window jamb using the **KIT BlauPlast 204x60-1** pre-installation kit. Available upon separate order.

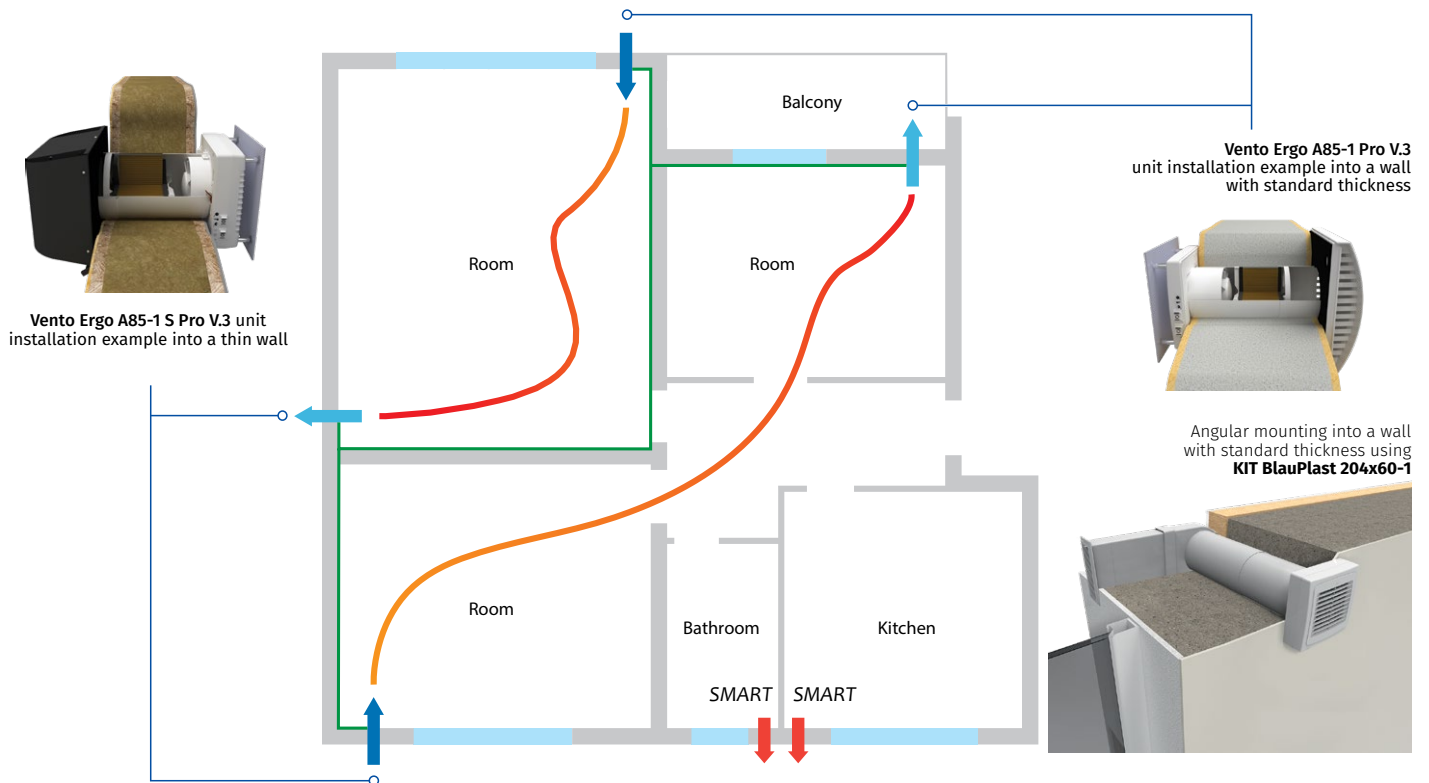

VENTO ERGO A85-1 PRO V.3

HEAT RECOVERY SINGLE-ROOM UNITS

Technical data

Parameters	Vento Ergo A85-1 Pro V.3		
	I	II	III
Speed			
Voltage [V / 50 (60) Hz]	1 ~ 100-240		
Power [W]	4.74	6.56	9.65
Current [A]	0.034	0.050	0.071
RPM [min ⁻¹]	1000	1500	2045
Maximum air flow [m ³ /h (l/s)]	36 (10)	59 (16)	85 (24)
Air flow in heat recovery mode [m ³ /h (l/s)]	18 (5)	30 (8)	43 (12)
SFP [W/l/s]	0.95	0.80	0.82
Filter	G3 (Option: G4, F8 PM2.5 > 99 %*)		
Outdoor sound pressure attenuation according to DIN EN 20140 [dBA]	40		
Sound pressure level at 1 m according to ISO 3741: 2004 [dBA]	29	35	44
Sound pressure level at 3 m according to ISO 3741: 2004 [dBA]	19	25	34
Heat recovery efficiency according to DIBt LÜ-A 20 [%]	up to 90		
Transported air temperature [°C]	-20...+40		
Ingress protection rating	IP24		

* maximum air flow 40 m³/h

ENERGY LABEL: A (Energy efficiency), 45 dB (Sound power level), 43 m³/h (Air flow)

Overall dimensions [mm]

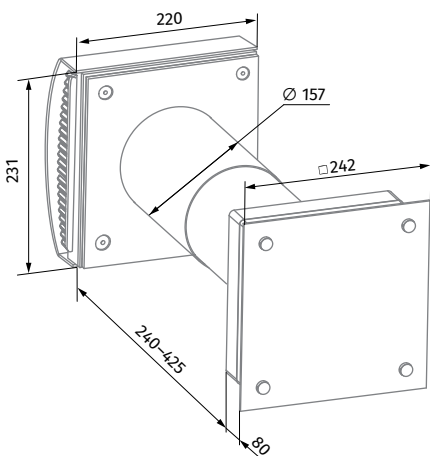

Vento Ergo A85-1 Pro V.3

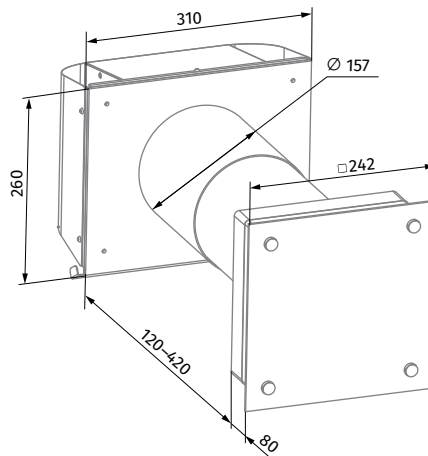































Vento Ergo A85-1 S Pro V.3

VENTO ERGO A85-1 PRO V.3

HEAT RECOVERY SINGLE-ROOM UNITS

Accessories

Name		Description												
Pre-installation Kit Vento Ergo A50 S10 Pro		Pre-installation kit for mounting into a wall with standard thickness. Includes: <ul style="list-style-type: none"> • Round telescopic air duct with the diameter of 150 mm and adjustable length from 240 to 460 mm • AH-10 white 160 outer ventilation hood • Plastic foam plug • Plastic foam wedges 												
Completion Kit Vento Ergo A85-1 Pro V.3		Includes: <ul style="list-style-type: none"> • Ceramic regenerator \varnothing 150 mm • Vento Ergo A85-1 ventilation unit • G3 filters • Mounting plate • Remote control 												
FP Vento Ergo A50 G3		G3 filters (2 pcs.)												
FPC 150x50 G4		G4 filter												
FP Vento Ergo A50 F8		F8 filter												
AH-10 *colour* 160		Plastic outer ventilation hood. Available in colours: <table style="display: inline-table; vertical-align: middle;"> <tr> <td></td> <td></td> <td></td> <td></td> <td></td> <td></td> </tr> <tr> <td>white</td> <td>black</td> <td>grey</td> <td>terracotta</td> <td>brown</td> <td>vintage</td> </tr> </table>							white	black	grey	terracotta	brown	vintage
														
white	black	grey	terracotta	brown	vintage									
AH-10 chrome 160		Plastic outer ventilation hood with a plate with brushed stainless steel effect finish												
AH-S grey 160		Outer ventilation hood for thin wall, painted grey												
AH-S chrome 160		Outer ventilation hood for thin wall made of brushed stainless steel												
PP 160/0.5		Outer ventilation hood for mounting from inside												
KIT BlauPlast 204x60-1		Installation kit for angular mounting. Includes: <ul style="list-style-type: none"> • Plastic ventilation grille 230x86 mm • Plastic air duct 204x60 mm • Plastic connecting bend from \varnothing 150 to 204x60 mm 												
FB Vento Ergo		Remote control												