



## **AIR HANDLING UNIT**



**BlauAir CFV**

**EN**

**USER'S MANUAL**



**BLAUBERG**  
Ventilatoren

## CONTENTS

Safety requirements.....	2
Purpose.....	4
Delivery set.....	4
Designation key.....	4
Technical data.....	5
Unit design and operating logic.....	7
Installation and set-up.....	9
Connection to power mains.....	12
Technical maintenance.....	12
Storage and transportation regulations.....	14
Manufacturer's warranty.....	15
Certificate of acceptance.....	19
Seller information.....	19
Installation certificate.....	19
Warranty card.....	19

This user's manual is a main operating document intended for technical, maintenance, and operating staff.

The manual contains information about purpose, technical details, operating principle, design, and installation of the BlauAir CFV unit and all its modifications.

Technical and maintenance staff must have theoretical and practical training in the field of ventilation systems and should be able to perform works in accordance with workplace safety rules as well as construction norms and standards applicable in the territory of the country.

The information in this user's manual is correct at the time of the document's preparation.

The Company reserves the right to modify the technical characteristics, design, or configuration of its products at any time in order to incorporate the latest technological developments.

No part of this publication may be reproduced, stored in a retrieval system, or transmitted, in any form or by any means in any information search system or translated into any language in any form without the prior written permission of the Company.

## SAFETY REQUIREMENTS

- Please read the user's manual carefully prior to installing and operating the unit.
- All user's manual requirements as well as the provisions of all the applicable local and national construction, electrical, and technical norms and standards must be observed when installing and operating the unit.
- The warnings contained in the user's manual must be considered most seriously since they contain vital personal safety information.
- Failure to follow the rules and safety precautions noted in this user's manual may result in an injury or unit damage.
- After a careful reading of the manual, keep it for the entire service life of the unit.
- While transferring the unit control, the user's manual must be turned over to the receiving operator.

### UNIT INSTALLATION AND OPERATION SAFETY PRECAUTIONS



- Disconnect the unit from power mains prior to any installation operations.



- Unpack the unit with care.



- The unit must be grounded!



- While installing the unit, follow the safety regulations specific to the use of electric tools.



- Do not change the power cable length at your own discretion. Do not bend the power cable. Avoid damaging the power cable. Do not put any foreign objects on the power cable.

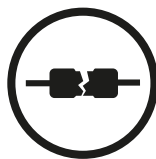

- Do not use damaged equipment or cables when connecting the unit to power mains.



- Do not touch the unit controls with wet hands. Do not carry out the installation and maintenance operations with wet hands.



- Do not allow children to operate the unit.



- Do not store any explosive or highly flammable substances in close proximity to the unit.

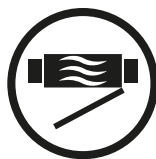

- Do not open the unit during operation.



- Do not block the air duct when the unit is switched on.

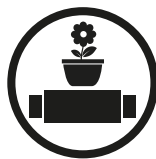

- Do not sit on the unit and avoid placing foreign objects on it.



- Do not lay the power cable of the unit in close proximity to heating equipment.



- Do not operate the unit outside the temperature range stated in the user's manual. Do not operate the unit in aggressive or explosive environments.



- Do not wash the unit with water. Protect the electric parts of the unit against ingress of water.

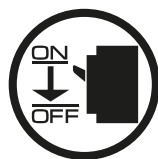

- Disconnect the unit from power mains prior to any technical maintenance.



- When the unit generates unusual sounds, odour, or emits smoke, disconnect it from power supply and contact the Seller.



- Do not direct the air flow produced by the unit towards open flame or ignition sources.



- In case of continuous operation of the unit, periodically check the security of mounting.



- Use the unit only for its intended purpose.



**THE PRODUCT MUST BE DISPOSED SEPARATELY AT THE END OF ITS SERVICE LIFE.  
DO NOT DISPOSE THE UNIT AS UNSORTED MUNICIPAL WASTE.**

**PURPOSE**

The air handling unit with heat recovery is designed for integration into central mechanical ventilation systems. The unit is rated for continuous operation. Transported air must not contain any flammable or explosive mixtures, evaporation of chemicals, sticky substances, fibrous materials, coarse dust, soot and oil particles or environments favourable for the formation of hazardous substances (toxic substances, dust, pathogenic germs). The unit has C4 corrosion resistance class in compliance with ISO 12944.



**THE UNIT SHOULD NOT BE OPERATED BY CHILDREN OR PERSONS WITH REDUCED PHYSICAL, MENTAL, OR SENSORY CAPACITIES, OR THOSE WITHOUT THE APPROPRIATE TRAINING.**

**THE UNIT MUST BE INSTALLED AND CONNECTED ONLY BY PROPERLY QUALIFIED PERSONNEL AFTER THE APPROPRIATE BRIEFING.**

**THE CHOICE OF UNIT INSTALLATION LOCATION MUST PREVENT UNAUTHORIZED ACCESS BY UNATTENDED CHILDREN.**

**DELIVERY SET**

<b>Name</b>	<b>Number</b>
Unit	1 pc.
User's manual	1 pc.
Technical data sheet	1 pc.
Automation wiring	1 pc.
Control panel	1 pc.
User's manual for automation	1 pc.
Packing box	1 pc.

**DESIGNATION KEY**

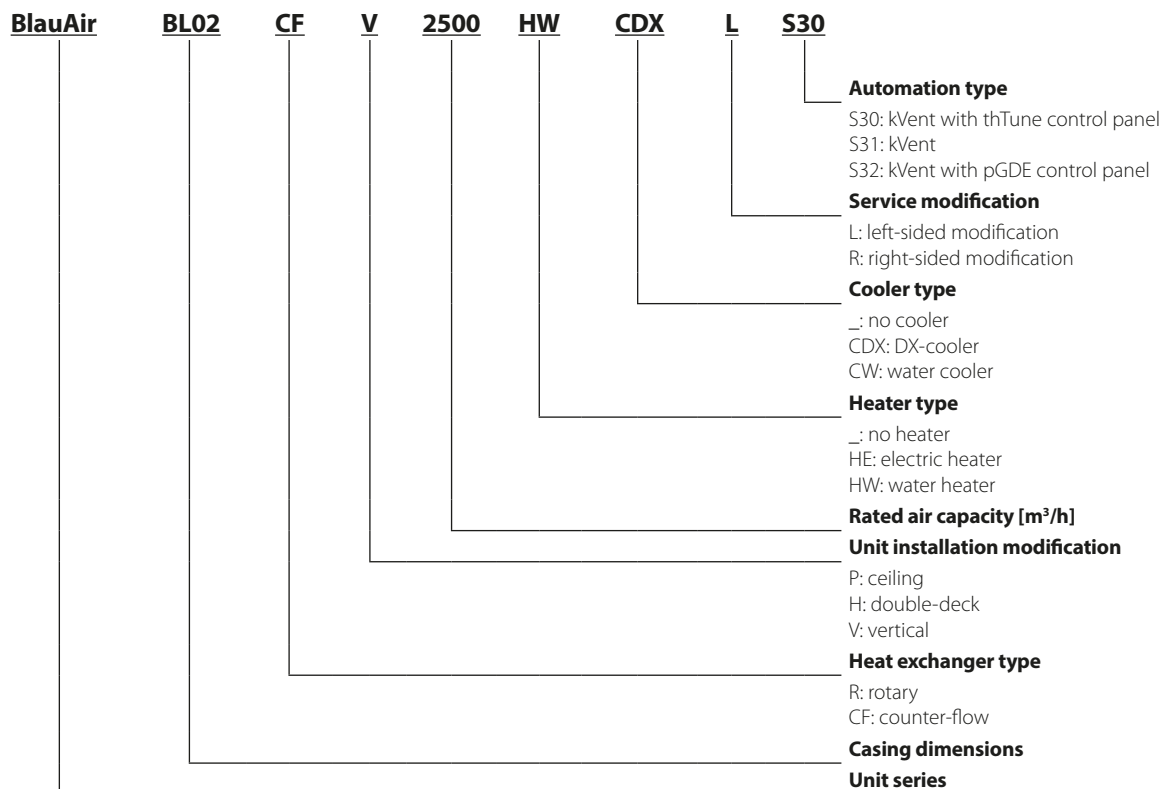

## TECHNICAL DATA

The unit is designed for indoor or sheltered use. The installation conditions must prevent ingress of atmospheric precipitations and direct solar radiation at the ambient temperatures from  $-35\text{ °C}$  up to  $+50\text{ °C}$ .

Outdoor unsheltered mounting is allowed provided an extra cover and weather hoods are installed on the air ducts (not included in the delivery set). The frost protection for the water drainage and connected pipelines must be provided during sub-zero ambient temperatures (if the unit is equipped with air cooler). The heat medium temperature in the water heat exchangers (if available) must be sufficient to prevent its freezing.

Hazardous parts access and water ingress protection rating:

- IP54 for the unit motors
- IP40 for the assembled unit connected to the air ducts without extra cover or weather hoods
- IP44 for the assembled unit with connected air ducts, extra cover and weather hoods (specially ordered accessories)

IP00 for the unit not connected to the air ducts

The unit design is constantly being improved, thus some models may be slightly different from those described in this manual.

### UNIT OVERALL DIMENSIONS [mm]

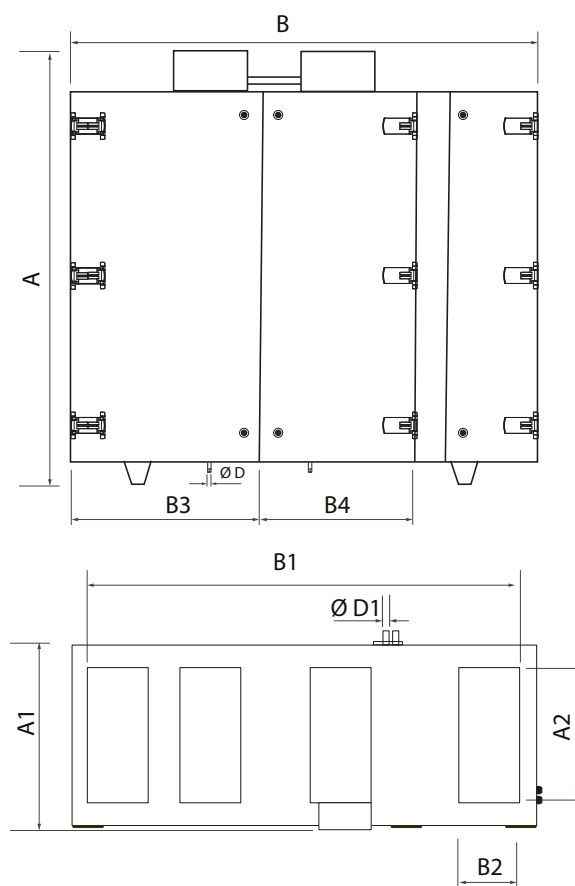

Model	A	A1	A2	B	B1	B2	B3	B4	D	D1
BL02 CFV 1500 BL02 CFV 2500	1822	776	600	1979	1856	300	774	654	18	—
BL02 CFV 1500-HE BL02 CFV 2500-HE										3/4'
BL02 CFV 1500-HW BL02 CFV 2500-HW										—
BL03CFV 3500	2070	916	600	2223	2130	300	895	782		—
BL03 CFV 3500-HE										3/4'
BL03 CFV 3500-HW										—
BL07 CFV 5000 BL07 CFV 6000	2070	1458	1000	2350	2195	400	925	773		—
BL07 CFV 5000-HE BL07 CFV 6000-HE										1'
BL07 CFV 5000-HW BL07 CFV 6000-HW										—

The full technical data list is stated in the supplied technical data sheet.

**UNIT DESIGN AND OPERATING LOGIC**

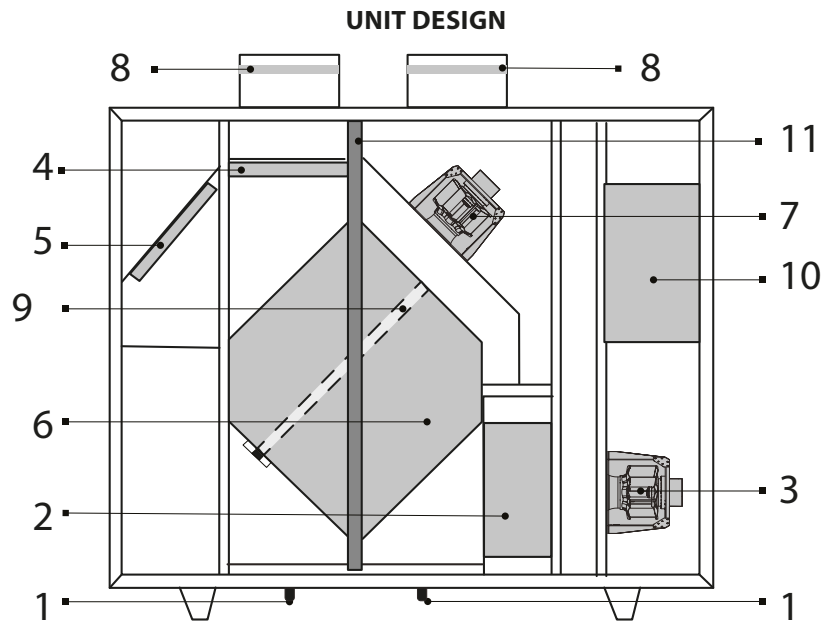

- 1: drain pipe
- 2: electric heater (only for the units with electric heater), water heater (only for the units with water heater)
- 3: supply fan
- 4: supply filter
- 5: extract fan
- 6: heat exchanger
- 7: extract fan
- 8: air flow control damper with electric actuator
- 9: bypass damper
- 10: control unit
- 11: removable holder

The unit design provides change of the air duct positioning. For this purpose the side walls are plugged.

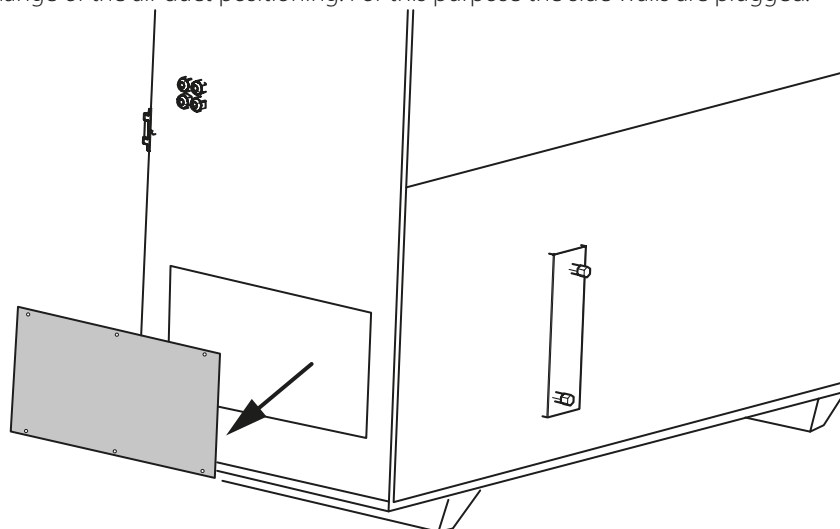

To change positioning of the air ducts use the plugs from the side walls for the front panel.

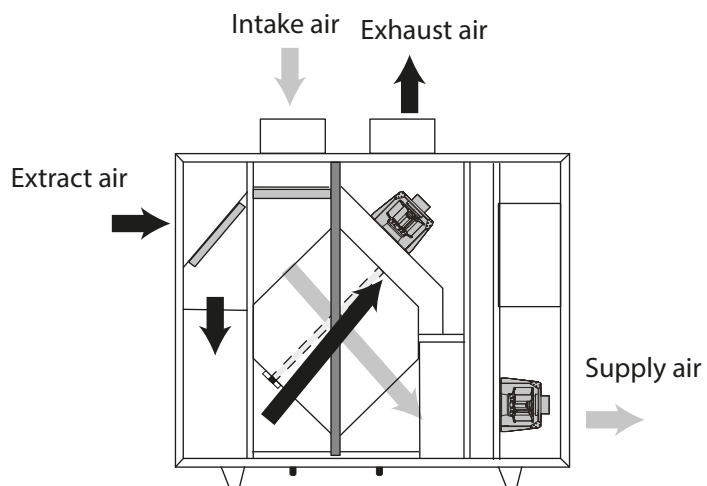



**INSTALLATION AND SET-UP**



**ALL OPERATIONS DESCRIBED IN THIS USER'S MANUAL MUST BE PERFORMED BY QUALIFIED PERSONNEL ONLY, PROPERLY TRAINED AND QUALIFIED TO INSTALL AND MAINTAIN VENTILATION EQUIPMENT.**

**DO NOT ATTEMPT TO INSTALL THE PRODUCT YOURSELF. IT IS UNSAFE AND IMPOSSIBLE WITHOUT SPECIAL KNOWLEDGE.**

The units are available in left- and right-sided modifications with the right or left service side. All the assembly units are accessible on the service side.

**Left-sided modification (service side view)**

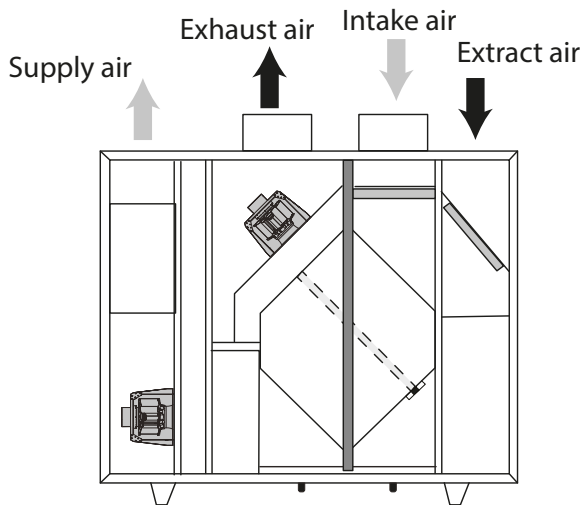

**Right-sided modification (service side view)**

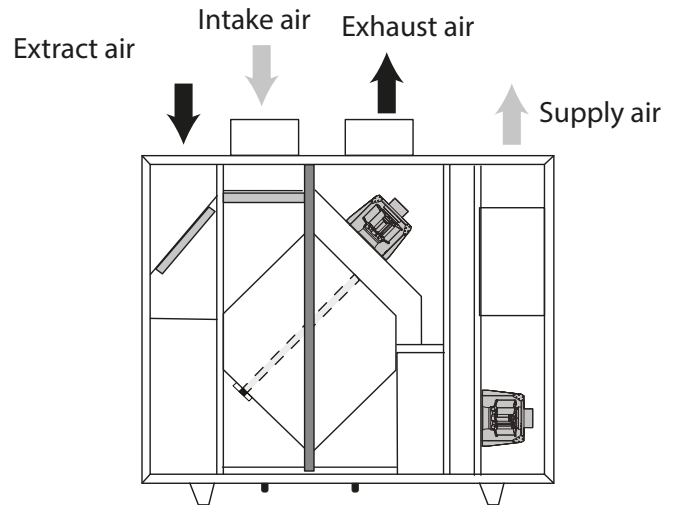

Connection of the air ducts is shown with the stickers of the respective colours: yellow for the extract air duct, green for the intake air duct, red for the supply air duct and brown for the exhaust air duct.

During installation works sufficient maintenance and service access must be provided.

The recommended minimum distances from the unit to the walls are shown below.

For the models with a water heater

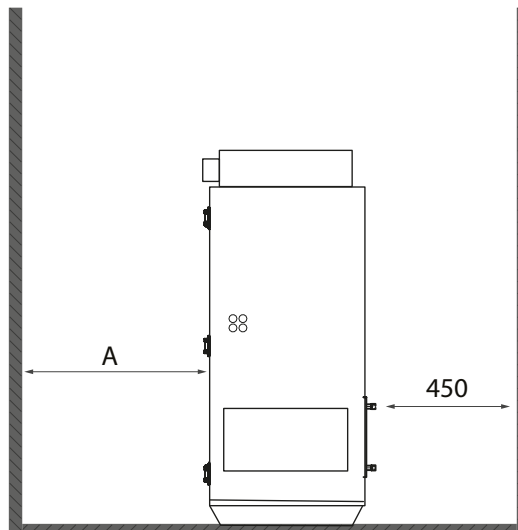

For the models without water heater

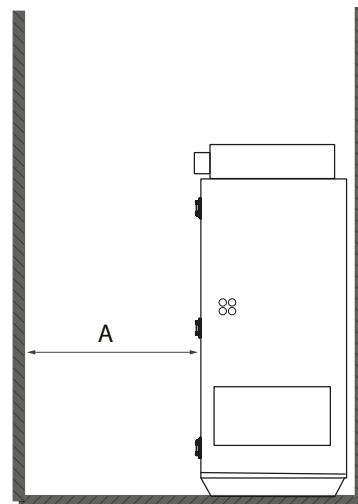

Casing dimensions	A [mm]
BL02 CFV	850
BL03 CFV BL07 CFV	1000

The delivery set includes removable levelling feet to adjust horizontal levelling of the unit and provide required clearance from the floor to enable correct mounting of the condensed water drainage.

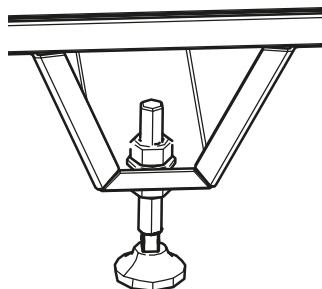

**Condensate drainage**

The unit is equipped with drain pipes to remove condensed water outside of the unit. U-traps must be connected to the drain pipes. Dimensions of the U-trap must be selected based on air pressure in the section and are stated in the table.

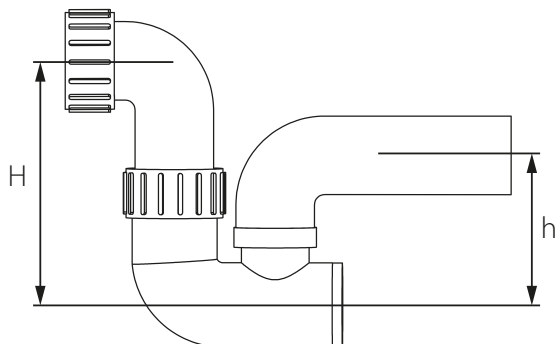

Complete fan pressure [Pa]	Size H [mm]	Size h [mm]
<600	100	50
600-1000	140	70
1000-1400	190	95
1400-1800	240	120
1800-2200	290	145
2200-2600	340	170

Connect the drain pipe, U-trap and sewage system using metal, plastic or rubber connecting pipes.

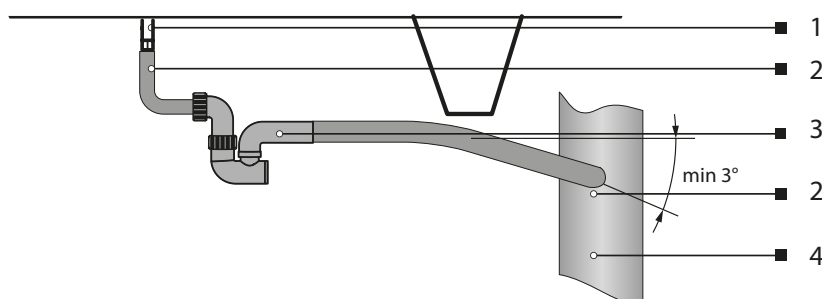

- 1: drain pipe
- 2: connecting pipe
- 3: U-trap
- 4: sewage system

Prior to starting operation make sure that water has unobstructed flow in the sewage system. Fill the U-trap with water before operation.

**Connection of the water heater (only for the models with water heater)**

While connecting the water heater keep the straight air duct section length not less than 400 mm from the unit. Otherwise the maintenance panel cannot be opened!

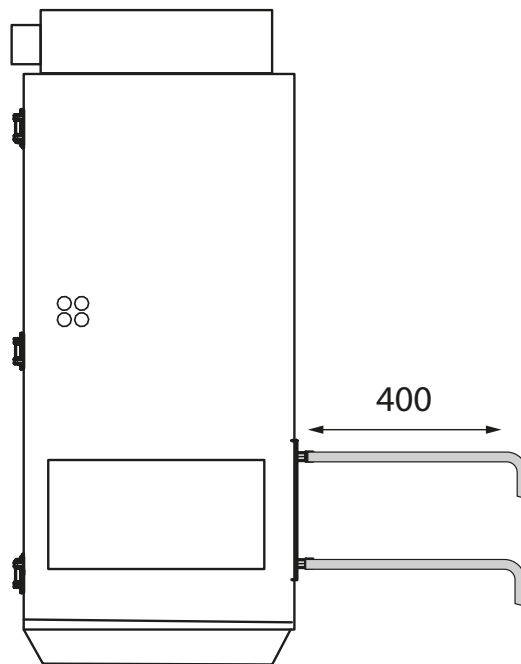

## CONNECTION TO POWER MAINS

Connection to power mains must be conducted in compliance with the automation user's manual.

## TECHNICAL MAINTENANCE



**OPEN THE UNIT FOR INSPECTION AND SERVICE NOT LESS THAN 2 MINUTES AFTER COMPLETE DE-ENERGIZING OF THE UNIT. THE FANS ROTATION MAY BE STILL PRESENT.**



**IN CASE OF ANY ABNORMAL NOISE, SMELL AND COMPONENT DEFORMATION IMMEDIATELY CUT OFF POWER SUPPLY TO THE UNIT AND CONTACT A SERVICE PROVIDER OR THE UNIT SELLER.**

The unit operation requires regular inspection, dry cleaning of inner components, check-up and replacement of air filters in case of filter contamination. 3-6 months after commissioning of the unit it must be inspected by a service expert for planned preventive maintenance of the unit. Next maintenance operations must be conducted at least every 6-12 months.

Maintenance periodicity is determined by a service expert depending on operation conditions of the unit. Dust deposits on the inner parts of the unit, especially in the electric heater, may lead to unpleasant odours. It is not a malfunction. Clean the unit to troubleshoot unpleasant odours.

Open the service doors to access the filters.

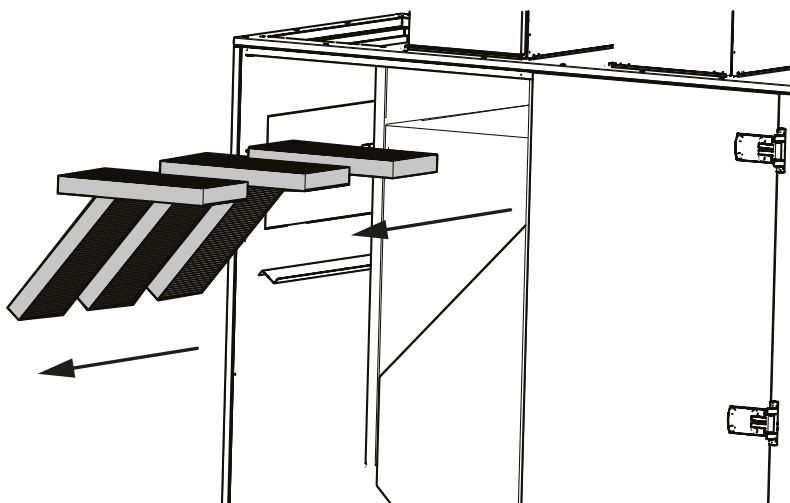

Remove the filter elements.

To access the heat exchanger remove the holder 13 (see page 7).  
Loosen the screws (1) on the retaining clamps (2) using a hexagon wrench.

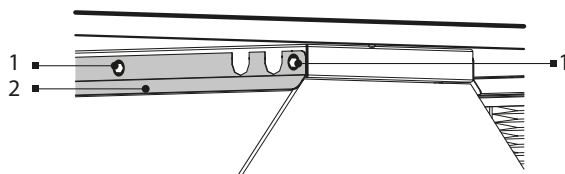

Pull the heat exchanger out.

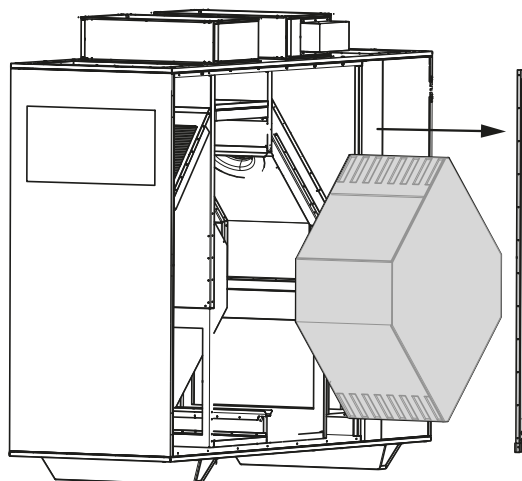

## STORAGE AND TRANSPORTATION REGULATIONS

- Store the unit in the manufacturer's original packaging box in a dry closed ventilated premise with temperature range from +5 °C to +40 °C at RH not exceeding 70%.
- Storage environment must not contain aggressive vapours and chemical mixtures provoking corrosion, insulation, and sealing deformation.
- Use suitable hoist machinery for handling and storage operations to prevent possible damage to the unit.
- Follow the handling requirements applicable for the particular type of cargo.
- The unit can be carried in the original packaging by any mode of transport provided proper protection against precipitation and mechanical damage. The unit can be transported only in the working position.
- Avoid sharp blows, scratches, or rough handling during loading and unloading.
- Prior to the initial power-up after transportation at sub-zero temperatures, allow the unit to warm up at operation temperatures for at least 3-4 hours.

## MANUFACTURER'S WARRANTY

The product is in compliance with EU norms and standards on low voltage guidelines and electromagnetic compatibility. We hereby declare that the product complies with the provisions of Electromagnetic Council Directive 2014/30/EU, Low Voltage Directive 2014/35/EU and CE-marking Directive 93/68/EEC. This certificate is issued following test carried out on samples of the product referred to above. The manufacturer hereby warrants normal operation of the unit for 24 months after the retail sale date provided the user's observance of the transportation, storage, installation, and operation regulations. Should any malfunctions occur in the course of the unit operation through the Manufacturer's fault during the guaranteed period of operation, the user is entitled to get all the faults eliminated by the manufacturer by means of warranty repair at the factory free of charge. The warranty repair includes work specific to elimination of faults in the unit operation to ensure its intended use by the user within the guaranteed period of operation. The faults are eliminated by means of replacement or repair of the unit components or a specific part of such unit component.

### The warranty repair does not include:

- routine technical maintenance
- unit installation/dismantling
- unit setup

To benefit from warranty repair, the user must provide the unit, the user's manual with the purchase date stamp, and the payment paperwork certifying the purchase. The unit model must comply with the one stated in the user's manual. Contact the Seller for warranty service.

### The manufacturer's warranty does not apply to the following cases:

- User's failure to submit the unit with the entire delivery package as stated in the user's manual including submission with missing component parts previously dismantled by the user.
- Mismatch of the unit model and the brand name with the information stated on the unit packaging and in the user's manual.
- User's failure to ensure timely technical maintenance of the unit.
- External damage to the unit casing (excluding external modifications as required for installation) and internal components caused by the user.
- Redesign or engineering changes to the unit.
- Replacement and use of any assemblies, parts and components not approved by the manufacturer.
- Unit misuse.
- Violation of the unit installation regulations by the user.
- Violation of the unit control regulations by the user.
- Unit connection to power mains with a voltage different from the one stated in the user's manual.
- Unit breakdown due to voltage surges in power mains.
- Discretionary repair of the unit by the user.
- Unit repair by any persons without the manufacturer's authorization.
- Expiration of the unit warranty period.
- Violation of the unit transportation regulations by the user.
- Violation of the unit storage regulations by the user.
- Wrongful actions against the unit committed by third parties.
- Unit breakdown due to circumstances of insuperable force (fire, flood, earthquake, war, hostilities of any kind, blockades).
- Missing seals if provided by the user's manual.
- Failure to submit the user's manual with the unit purchase date stamp.
- Missing payment paperwork certifying the unit purchase.



**FOLLOWING THE REGULATIONS STIPULATED HEREIN WILL ENSURE A LONG AND TROUBLE-FREE OPERATION OF THE UNIT.**



**USER'S WARRANTY CLAIMS SHALL BE SUBJECT TO REVIEW ONLY UPON PRESENTATION OF THE UNIT, THE PAYMENT DOCUMENT AND THE USER'S MANUAL WITH THE PURCHASE DATE STAMP.**









**CERTIFICATE OF ACCEPTANCE**

<b>Unit Type</b>	Air handling unit
<b>Model</b>	BlauAir BL___CFV_____
<b>Serial Number</b>	
<b>Manufacture Date</b>	
<b>Quality Inspector's Stamp</b>	

**SELLER INFORMATION**

<b>Seller</b>	
<b>Address</b>	
<b>Phone Number</b>	
<b>E-mail</b>	
<b>Purchase Date</b>	
This is to certify acceptance of the complete unit delivery with the user's manual. The warranty terms are acknowledged and accepted.	
<b>Customer's Signature</b>	

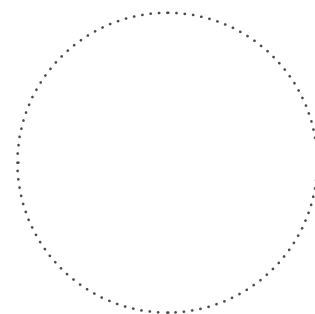

Seller's Stamp

**INSTALLATION CERTIFICATE**

The BlauAir BL\_\_\_CFV\_\_\_\_\_ unit has been connected to power mains pursuant to the requirements stated in the present user's manual.

<b>Seller</b>	
<b>Address</b>	
<b>Phone Number</b>	
<b>Installation Technician's Full Name</b>	
<b>Installation Date:</b>	<b>Signature:</b>
The unit has been installed in accordance with the provisions of all the applicable local and national construction, electrical and technical codes and standards. The unit operates normally as intended by the manufacturer.	
<b>Signature:</b>	

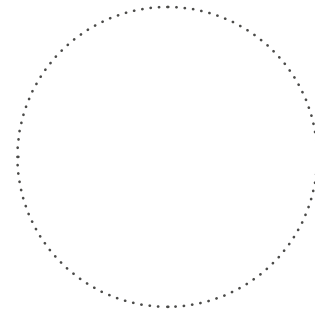

Installation Stamp

**WARRANTY CARD**

<b>Unit Type</b>	Air handling unit
<b>Model</b>	BlauAir BL___CFV_____
<b>Serial Number</b>	
<b>Manufacture Date</b>	
<b>Purchase Date</b>	
<b>Warranty Period</b>	
<b>Seller</b>	

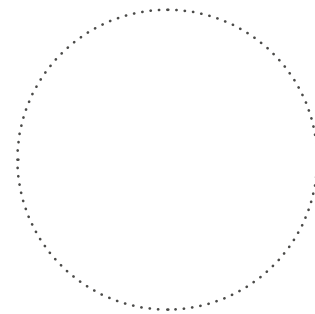

Seller's Stamp



**BLAUBERG**  
*Ventilatoren*

