

Clean Box

Filter boxes for round ducts

Use

- For purification of supply air in ventilation and air conditioning systems installed in various premises
- Suitable for limited mounting space.
- Compatible with Ø 100 up to 200 mm round air ducts.



Design

- The casing is made of polymer-coated steel.
- Easy access for filter maintenance.

Mounting

- Due to compact design is the ideal solution for mounting in limited spaces, including the space behind false ceiling.
- Any mounting position.
- Wall or ceiling mounting with fixing brackets supplied as a standard.

Air filtration

- Built-in filters provide efficient air filtration. Up to three filters can be installed into the casing.
- **G4** filter provides primary filtration. At the second stage, the secondary filter **F8** or **HEPA** filter **H13** can be installed. F8 filter arrests up to 98 % of PM2.5 dust particles. **H13** filter arrest up to 99 % of PM2.5 dust particles, pollen and bacteria. For additional elimination of odors and gases carbon filter can be installed.
- Quick access to replaceable filters through service panel.

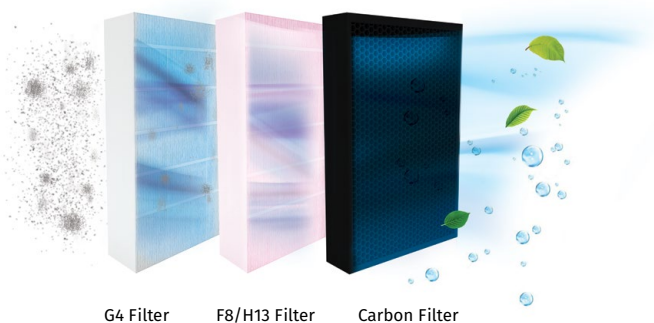

G4 Filter

F8/H13 Filter

Carbon Filter

Electrostatic filter

- The **Clean Box ES** is equipped with an electrostatic filter that enables purification of air from fine dust and soot, spray, smoke and other particles with the size of 0.01 microns and less.
- Max. filter cleaning efficiency 98 %.
- The electrostatic filters rely on gravity of oppositely charged objects.
- The polluted air stream flows through the spray charging unit for the particles ionization.
- Ionized particles are moved by the airstream and accumulated on the collecting plates which are oppositely charged.

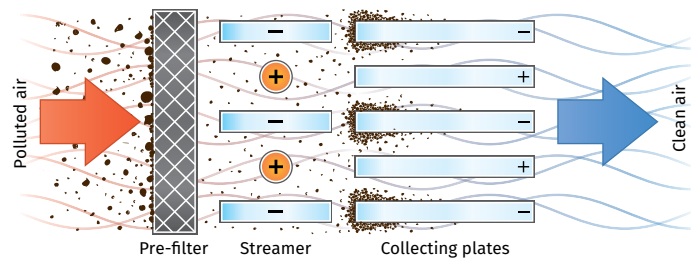

- The filter cleaning interval depends on the inlet air pollution density and may vary from 7 up to 21 days.
- The filter cleaning interval is determined by the visual inspection of the filters.
- Vacuum cleaning is allowed.

Designation key

Series	Duct diameter [mm]	Filters
Clean Box	100; 125; 150; 200	G4; G4-F8; G4-F8-Carbon; G4-H13; G4-H13-Carbon; ES

Accessories

Air disc valves	Duct system	Flexible air ducts	Grilles and hoods	Clamps
VPR / VSR / VMR	BlauPlast	BlauFlex	Decor / GM	K / KZ

Overall dimensions [mm]

Type	Ø D	L	H	B	L1	B1	L2	B2	Weight [kg]
Clean Box 100 G4-F8	100	413.5	249	415	513.5	508	358.5	458	7.47
Clean Box 100 G4-F8-Carbon	100	413.5	249	415	513.5	508	358.5	458	8.17
Clean Box 100 G4-H13	100	413.5	249	415	513.5	508	358.5	458	7.47
Clean Box 100 G4-H13-Carbon	100	413.5	249	415	513.5	508	358.5	458	8.18
Clean Box 100 ES	100	514	250	458	614	551	456	502	11.5
Clean Box 125 G4-F8	125	413.5	249	415	513.5	508	358.5	458	7.47
Clean Box 125 G4-F8-Carbon	125	413.5	249	415	513.5	508	358.5	458	8.17
Clean Box 125 G4-H13	125	413.5	249	415	513.5	508	358.5	458	7.47
Clean Box 125 G4-H13-Carbon	125	413.5	249	415	513.5	508	358.5	458	8.18
Clean Box 150 G4-F8	150	413.5	299	440	513.5	508	358.5	483	8.47
Clean Box 150 G4-F8-Carbon	150	413.5	299	440	513.5	508	358.5	483	9.04
Clean Box 150 G4-H13	150	413.5	299	440	513.5	508	358.5	483	8.47
Clean Box 150 G4-H13-Carbon	150	413.5	299	440	513.5	508	358.5	483	9.04
Clean Box 150 ES	150	514	300	458	614	551	456	502	12.7
Clean Box 200 G4-F8	200	413.5	299	605	513.5	508	358.5	648	10.62
Clean Box 200 G4-F8-Carbon	200	413.5	299	605	513.5	508	358.5	648	11.84
Clean Box 200 G4-H13	200	413.5	299	605	513.5	508	358.5	648	10.62
Clean Box 200 G4-H13-Carbon	200	413.5	299	605	513.5	508	358.5	648	11.84
Clean Box 200 ES	200	514	300	658	614	751	456	702	16.8

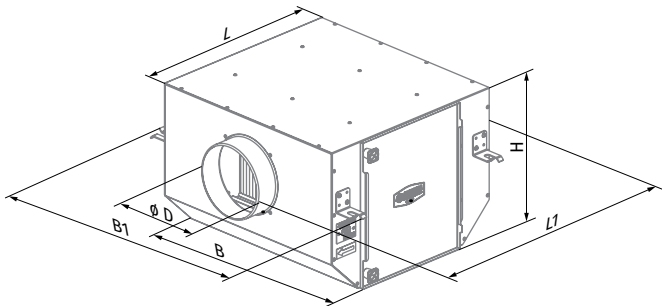





Application



FILTER BOXES

Replaceable filters

	Clean Box 100 (ES*) Clean Box 125	Clean Box 150 (ES*)	Clean Box 200 (ES*)
G4 Panel filter	 FP 220x400x47 G4	FP 270x425x47 G4	FP 270x590x47 G4
F8 Panel filter	 FP 220x400x47 F8	FP 270x425x47 F8	FP 270x590x47 F8
H13 Panel filter	 FP 220x400x47 H13	FP 270x425x47 H13	FP 270x590x47 H13
Carbon panel filter	 FP 220x400x47 C	FP 270x425x47 C	FP 270x590x47 C

* By default models with electrostatic filters ES are equipped with pre-filters G4. The G4 filter can be replaced by either F8, H13 or a carbon filter on request.

Technical data

CLEAN BOX 100

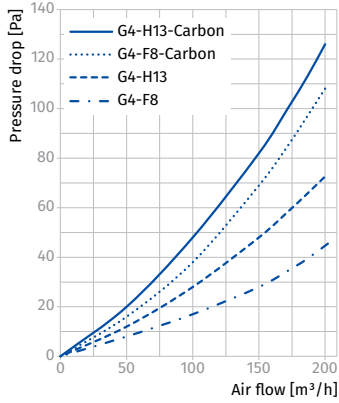

CLEAN BOX 125

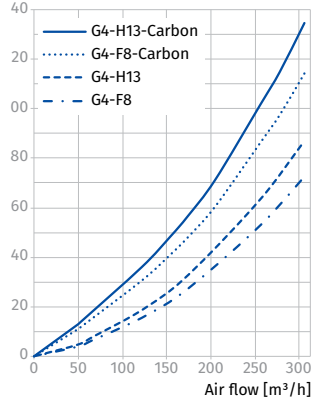

CLEAN BOX 150

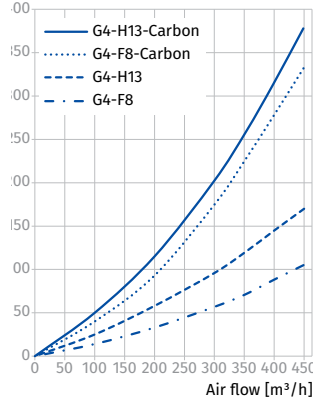

CLEAN BOX 200

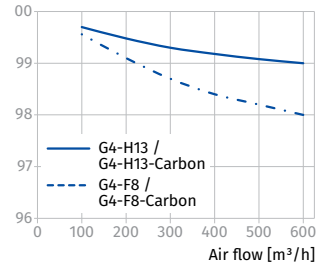
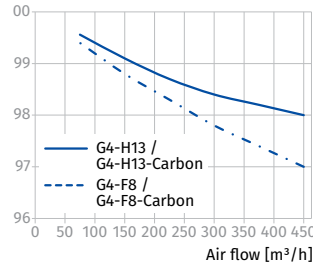
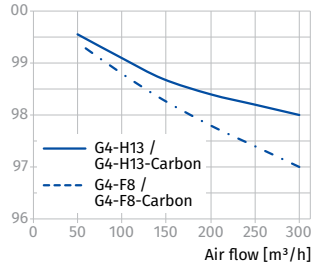
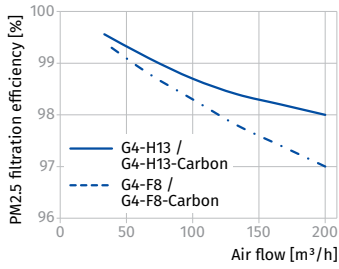
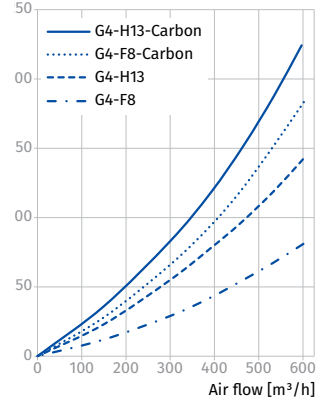

CLEAN BOX 100 ES

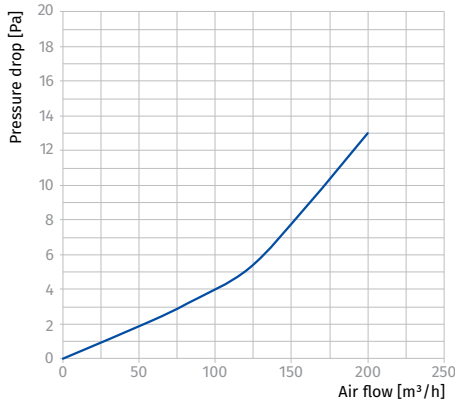

CLEAN BOX 150 ES

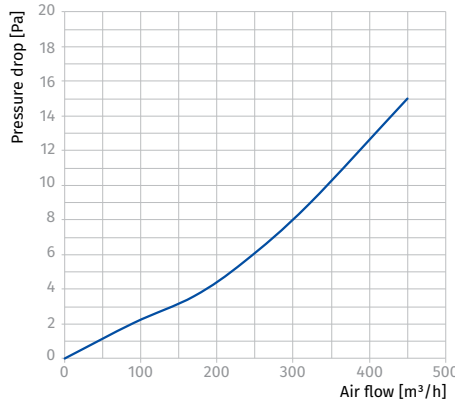

CLEAN BOX 200 ES

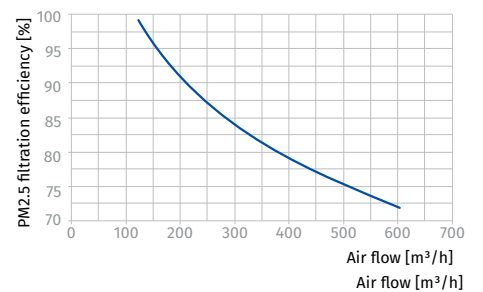
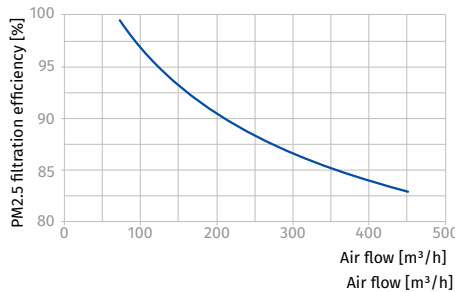
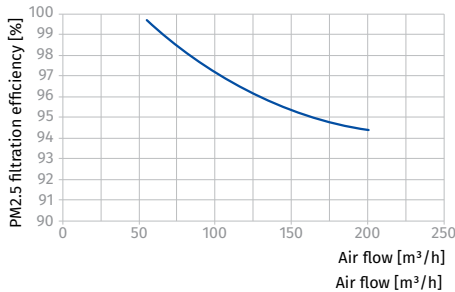
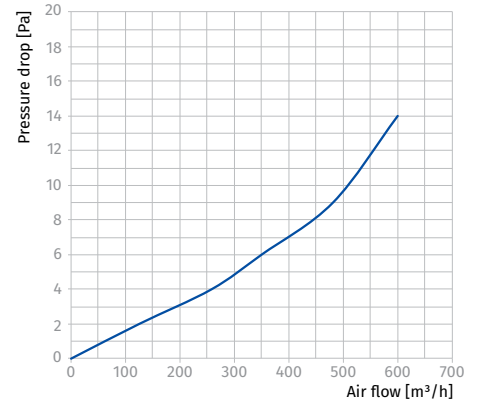

FILTER BOXES