



RESIDENTIAL VENTILATION

CONTENTS

Intelligent fans



SMART / SMART IR 6



CABRIO 8

Silent & energy saving



AERO STILL 20



BRAVO STILL 21

Silent & energy saving



CABRIO BASE 10



CABRIO BASE V2 12



SILEO / SILEO MAX 14



SILEO V2 15



SILEO DC 16



SILEO DESIGN 18



SILEO DESIGN V2 19

Classic models



AUTO 22



AUTO REVERS 23



AERO 24



BRAVO 25



SLIM 26



LINE 27



JET 28

Classic models



With decorative front panel



In-line fans



Window fans



Centrifugal fans

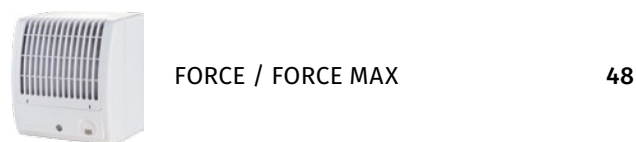
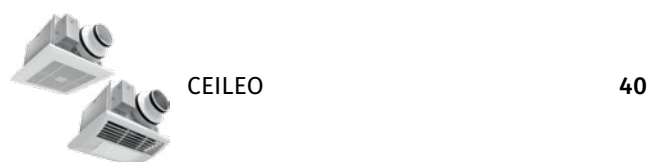

Wall vents

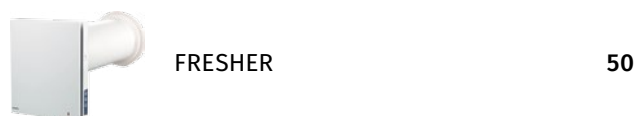

CONTENTS

Wall vents with solar panel

	SHM	56
---	-----	----

Window vents

	FHM	57
---	-----	----

Heat movers

	KIT AERO-BW	58
---	-------------	----

	KIT BRAVO-BW	59
---	--------------	----

Metal hoods

	DECOR S HK	60
---	------------	----

	DECOR S HK	61
---	------------	----

Plastic hoods

	DECOR H	62
---	---------	----

Plastic gravity grilles

	DECOR G	63
---	---------	----

Metal gravity grilles

	GM	64
---	----	----

Metal grilles

	DECOR-M	65
---	---------	----

	VDA CFn Al	66
---	------------	----

Plastic grilles

	DECOR	67
---	-------	----

	DECOR	68
---	-------	----

	DECOR	70
---	-------	----

	DECOR	71
---	-------	----

Metal air disc valves

	VMR	72
---	-----	----

Metal air disc valves



Plastic air disc valves



Aluminium door grilles



Plastic door grilles

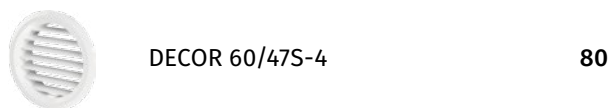
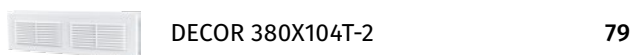
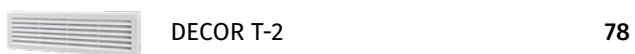

Access doors

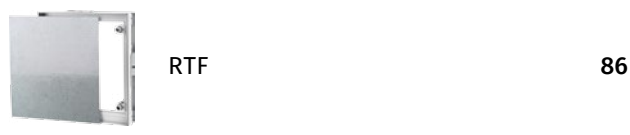

Thyristor speed controllers



CONTENTS

Multi-speed switches

	SGR-3/1	91
---	---------	----

	CDP-2/5 / CDP-3/5	92
---	-------------------	----

	CDP-2/10	93
---	----------	----

	CDPI-2(3) E5 / CDPE-2(3) E5	94
--	-----------------------------	----

Control unit for fans

	MCD 60/0.3	95
---	------------	----

Room thermostats

	TS E10	96
---	--------	----

Room temperature regulators

	MLC E2 / MLCD E2	97
---	------------------	----

Step-down transformers

	AT-25 220/12	98
---	--------------	----

Step-down transformers

	ATK-25 220/12	99
---	---------------	----

Round plastic duct system

	BLAUPLAST	100
---	-----------	-----

Flat plastic duct system

	BLAUPLAST	104
---	-----------	-----

Round and flat folding PVC duct system

	BLAUPLAST RRF/FKF	108
---	-------------------	-----

Flexible air ducts

	BLAUFLEX ISO N	109
---	----------------	-----

	BLAUFLEX	110
---	----------	-----

Fittings for round air ducts

	Fittings	112
---	----------	-----

SMART / SMART IR

INTELLIGENT FANS

Smart exhaust fans with stylish design for enhanced comfort in bathrooms, shower rooms, kitchens



Air flow:
up to 133 m³/h
37 l/s



Power:
up to 3.8 W
SFP:
up to 0.1 W/l/s



Noise level:
from 17 dBA



Savanna



Cosmos Black



Royal Granit



Brilliant Red



Platinum



Volcano Gray



Madeira

Features



- Intelligent electronics and integrated functions for the ideal microclimate.
- High air flow up to 133 m³/h and silent operation due to a specially designed motor and aerodynamic profiled impeller.
- High-efficient DC motor with low energy demand of max 3.8 W and reliable non-stop operation rated for above 50 000 hours.
- Impulse-type power supply unit with a wide power supply range from 100 to 240 V, 50 (60) Hz provides uninterrupted operation in electrical grids with versatile power supply standards.
- The fan has automatic power shutoff function in case of the motor jam.
- Low noise level due to specially designed fixation of the motor and the impeller on a vibration absorbing mount.
- The built-in slide switch makes it easy to disconnect the fan from power mains for safe operation.
- Ultrathin casing with 28 mm thickness.
- Versatile mounting – vertical or horizontal installation.
- Replaceable connecting piece for connection to Ø100 or 125 mm air ducts.

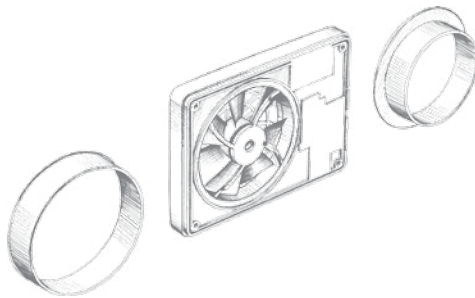

- Easy detachable motor and impeller block requires no tools and provides comfortable servicing.

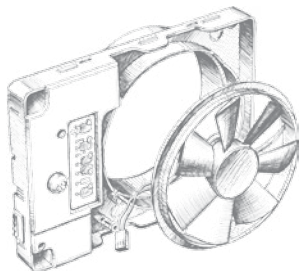

- Function setup and fan control from a remote controller.

- Multifunctional control panel with LED's:

- Smart

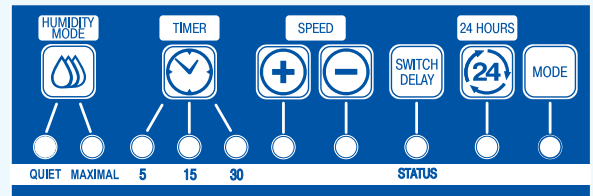

- Smart IR

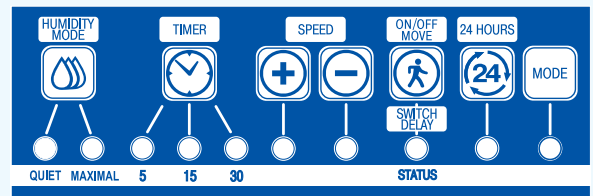

Designation key

Smart	IR	Savanna
Model	Option	Color

SMART / SMART IR

INTELLIGENT FANS

Modes and functions

The fan is developed with respect to the latest intelligent ventilation technologies:



INTELLIGENT HUMIDITY SENSOR

The fan is equipped with an intelligent humidity sensor for automatic control of natural indoor climate.

QUIET – the balanced humidity extraction mode that provides sufficient air flow (up to 83 m³/h) combined with silent operation. This mode is recommended for small bathrooms.

MAXIMAL – excessive humidity extraction mode with maximum air flow up to 133 m³/h. This mode is recommended to the bathrooms above 6 m².



TIMER

The fan is equipped with three various timer types for the most comfortable microclimate:

- **HUMIDITY TIMER** – adjustment of the operation time of the fan for total humidity removal after stabilization of its level, adjustable for 30, 45, 60 min.
- **TURN-OFF DELAY TIMER** – after activation of the IR motion sensor or the external switch the fan continues operating within 5, 15 or 30 min and then reverts to previous operation mode.
- **TURN-ON DELAY TIMER** – if you have to visit your bathroom frequently and briefly, adjust the turn-on delay function to avoid unnecessary switching of the fan.

The fan switches to higher speed in 0, 2 or 5 minutes after the humidity level increase or activation of the IR motion sensor.



24 HOURS

The fan runs with low speed to ensure minimum air exchange in the room. After humidity change, the fan switches to MAXIMAL (by default) or QUIET mode. After the signal from the IR-Sensor or an external switch the fan will turn to QUIET mode.



INTERVAL VENTILATION

Integrated function of the automatic room ventilation. Each 15 hours the fan is switched on for 2 hours to ventilate the premise with the air flow 83/72 m³/h (Ø 125/Ø 100).



SMOOTH SPEED CONTROL

The fan has an integrated smooth speed control function adjustable in 10 speeds:

- for QUIET mode from 40/33 to 83/72 m³/h (Ø 125/100);
- for MAXIMAL mode from 83/72 to 133/106 m³/h (Ø 125/100).



IR MOTION SENSOR (FOR SMART IR)

Automatic switching on of the fan in QUIET mode after the IR motion sensor is activated. Detection range from 1 up to 4 m, viewing angle – 100°.

Overall dimensions

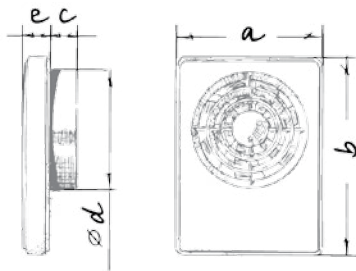

Dimensions [mm]	a	b	c	Ø d	e
Smart / Smart IR	155.5	209	28	99/124	28

Technical data

Model	Smart / Smart IR					
	Smart			Smart IR		
Spigot diameter [mm]	100			125		
Mode	24 hours	Quiet	Maximal	24 hours	Quiet	Maximal
Maximum air flow [m ³ /h (l/s)]	33 (9)	72 (20)	106 (29)	40 (11)	83 (23)	133 (37)
Noise level [dBA]	17	22	31	17	21	32
Air flow, factory settings [m ³ /h]	33	72	82	40	83	97
Control range [m ³ /h]	–	33...72	72...106	–	40...83	83...133



Accessories

Duct system	Flexible air ducts	Grilles and hoods	Clamps
BlauPlast	BlauFlex	Decor, GM	K, KZ

CABRIO

INTELLIGENT FANS

Innovative high-efficient extract fan with a DC motor, automatic shutters, low-noise operation and Wi-Fi control from a smartphone



Air flow:
up to 101 m³/h
28 l/s



Power:
from 3 W
SFP:
from 0.15 W/l/s



Noise level:
from 22 dBA



NEW

Features



- Low energy demand from 3 W due to a new energy-efficient DC motor.
- The casing and the impeller are made of high-quality, durable, UV resistant ABS plastic.
- Specially designed impeller aerodynamic profile provides high air flow and low-noise operation.
- The fan is equipped with a special mechanism for smooth opening and closing of the front panel.
- The fan extract spigot incorporates specially designed air rectifiers to reduce air turbulence and noise level.
- Due to the high ingress protection rating IP44 the fan is the ideal bathroom ventilation solution. The electronic components are protected with tight covers.
- The shortened spigot enables to install the fan in a the ventilation shaft with limited mounting space or to connect to a Ø 100 mm air duct.
- Multi-colour LED backlight (available for Cabrio Design 100).

Mounting example



Modes and functions

- The fan control, including the LED lighting colour selection, is performed with the "Blauberg Fan" mobile application.



INTELLIGENT HUMIDITY AND TEMPERATURE CONTROL

The fan has an integrated intelligent humidity and temperature sensor with the function of automatic keeping of the natural indoor climate.

The fan is able to set a balanced air **humidity level** for a serviced room. The fan functioning is defined by means of statistic analysis of the registered indoor humidity values.

The humidity threshold can be manually set from 40 % up to 80 %. If the indoor air humidity exceeds the set point, the fan turns on or goes to higher speed.

The **temperature threshold** is set manually. If the air temperature exceed the set point, the fan goes to high speed and operates at high speed until the indoor air temperature decreases 4 °C below the set point. After that the fan reverts to previous mode.



24 HOURS

24 hours: activation of this mode keeps the fan operating with the low speed. Once the humidity or temperature sensors are triggered or the external switch is operated the fan goes to the high speed.

Do not disturb (the function is available only if 24 hours mode is activated): this mode enables to set a time span for the fan to ignore triggering of sensors or a switch and to keep the fan running with low speed.



SMOOTH SPEED CONTROL

Silent: the fan runs with Silent speed. The speed is controlled over the range from 30 % up 100 % of the maximum air flow.

Max: the fan runs with Max speed. The speed is controlled over the range from 30 % up 100 % of the maximum air flow.



INTERVAL VENTILATION

Automatic interval ventilation (the function is available only if 24 hours mode is deactivated): this mode enables to turn on the function of automatic ventilation each 12 hours for 30 minutes with a set speed in case of a previous standstill of the fan within a day.

CABRIO

INTELLIGENT FANS

Unit design

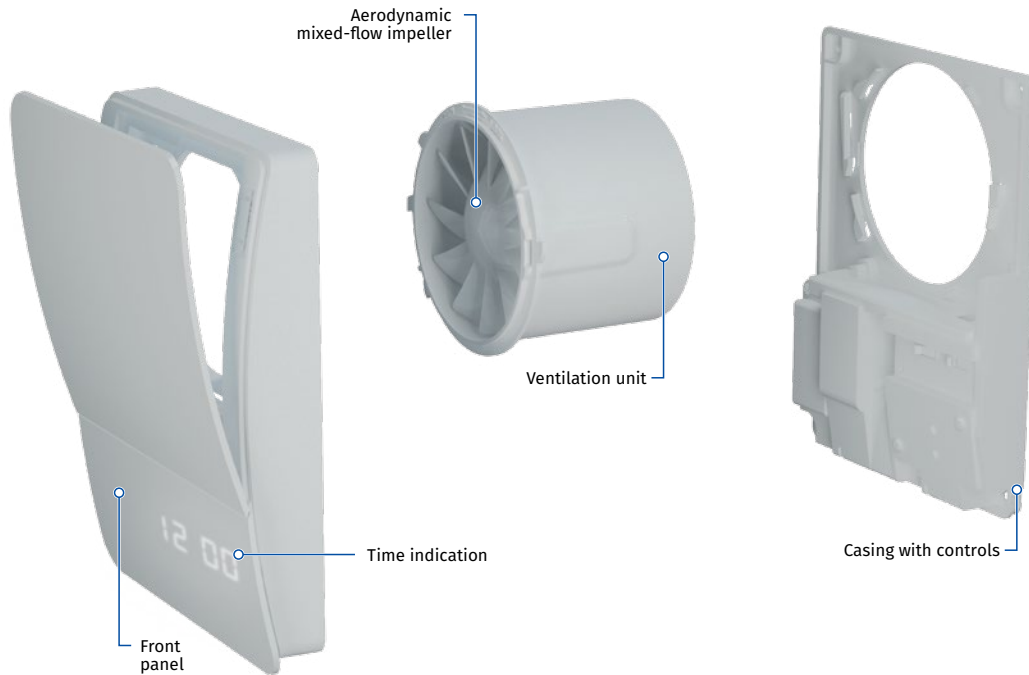

Options



Model	Cabrio 100	Cabrio Design 100
Option		
Timer	•	•
Humidity sensor	•	•
WiFi	•	•
LED lighting		•

o Timer

- Turn-off delay timer set for 5, 15, 30 or 60 min.
- Turn-on delay timer set for 0, 2 or 5 min.
- Interval timer set for 0, 6, 12 or 24 h.

o Humidity sensor

- Humidity set point adjustable from 40 % up to 80 %.

o WiFi

- Mode control via wireless network.

o LED lighting

- The colour of lighting can be selected to match the interior design.

Technical data

Model	Cabrio 100 / Cabrio Design 100	
	min.	max.
Speed		
Voltage [V]	220-240	
Frequency [Hz]	50/60	
Rated power [W]	3	5
Current [A]	0.126	0.196
RPM [min ⁻¹]	1850	2650
Air flow [m ³ /h (l/s)]	70 (19)	101 (28)
SFP [W/l/s]	0.15	0.18
Noise level [dBA]	22	27
Weight [kg]	0.55	

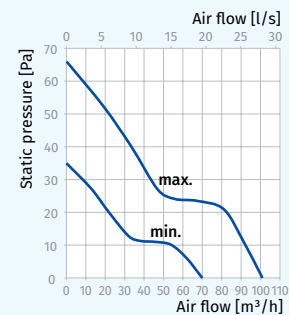

Designation key

Cabrio	Design	100
Model	LED lighting	Spigot diameter

Overall dimensions

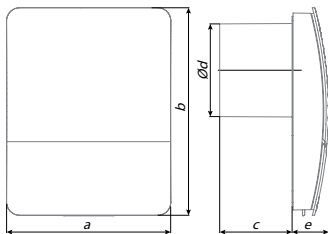

Dimensions [mm]	a	b	c	Ø d	e
Cabrio 100 / Cabrio Design 100	175	221	77	99	39

Accessories

Duct system	Flexible air ducts	Grilles and hoods	Clamps
BlauPlast	BlauFlex	Decor, GM	K, KZ

CABRIO BASE

SILENT & ENERGY SAVING

Innovative domestic extract fan
with automatic shutter, low-noise operation
and low energy consumption



Air flow:
97 m³/h
27 l/s



Power:
9 W
SFP:
0.33 W/l/s



Noise level:
25 dBA



Features



- Low energy demand not exceeding 9 W due to a new energy-efficient motor.
- The casing and the impeller are made of high-quality, durable, UV resistant ABS plastic.
- Specially designed impeller aerodynamic profile provides high air flow and low-noise operation.
- The motor is mounted on special anti-vibration dampers for absorption of vibration and low-noise operation. The motor is equipped with over-heating protection.
- Maintenance-free bearings contain enough lubricant for 40 000 hrs of non-stop operation of the motor.
- The fan is equipped with a special mechanism for smooth opening and closing of the front panel.
- The fan extract spigot incorporates specially designed air rectifiers to reduce air turbulence and noise level.
- The fan is controlled manually with a room light switch (not included in the delivery set).
- Due to the high ingress protection rating IP44 the fan is the ideal bathroom ventilation solution. The electronic components are protected with tight covers.
- The shortened spigot enables to install the fan in a the ventilation shaft or to connect to a Ø 100 mm air duct.
- The ventilation unit is easily removed from the casing for cleaning.
- Due to the modern design the fan can seamlessly blend with any interior design.

Mounting example



CABRIO BASE

SILENT & ENERGY SAVING

Options



Model	Cabrio Base 100	
Option	T	H
Timer	•	•
Humidity sensor		•

Timer

- Turn-off delay timer adjustable from 2 to 30 min.
- Turn-on delay timer set for 60 sec.
- Interval timer set for 0, 6, 12 or 24 h.

Humidity sensor

- Humidity setpoint adjustable from 60 % up to 90 %.

Overall dimensions

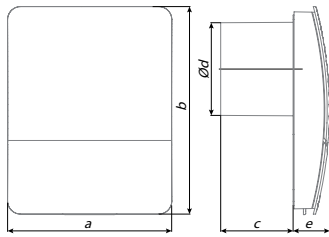

Dimensions [mm]	a	b	c	Ø d	e
Cabrio Base 100	175	221	77	99	39

Designation key		
Cabrio Base	100	T
Model	Spigot diameter	Option

Technical data

Model	Cabrio Base 100	Cabrio Base 100 (220-240V/60Hz)
Voltage [V]		220-240
Frequency [Hz]	50	60
Rated power [W]		9
Current [A]		0.059
RPM [min ⁻¹]		2160
Air flow [m ³ /h (l/s)]		97 (27)
SFP [W/l/s]		0.33
Noise level [dBA]		25
Weight [kg]		0.55

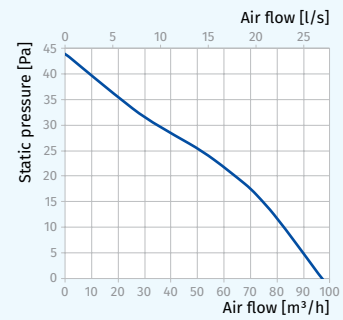

Accessories

Duct system	Flexible air ducts	Grilles and hoods	Speed controllers	Clamps
BlauPlast	BlauFlex	Decor, GM	SGS E1 CDT E1.8 MCD 60/0.3	K, KZ

CABRIO BASE V2

SILENT & ENERGY SAVING

Innovative two-speed domestic extract fan with automatic shutter, low-noise operation and low energy consumption



Air flow:
up to 90 m³/h
25 l/s



Power:
from 6 W
SFP:
from 0.34 W/l/s



Noise level:
from 22 dBA



Features



- Low energy demand from 6 W due to a new energy-efficient two-speed motor.
- The casing and the impeller are made of high-quality, durable, UV resistant ABS plastic.
- Specially designed profile of the mixed-flow impeller provides high air flow and low-noise operation.
- The motor is mounted on special anti-vibration dampers for absorption of vibration. The motor is equipped with overheating protection.
- Maintenance-free bearings contain enough lubricant for 40 000 hrs of non-stop operation of the motor.
- The fan is equipped with a special mechanism for smooth opening and closing of the front panel.
- The fan extract spigot incorporates specially designed air rectifiers to reduce air turbulence and noise level.
- Due to the high ingress protection rating IP44 the fan is the ideal bathroom ventilation solution. The electronic components are protected with tight covers.
- The ventilation unit is easily removed from the casing for cleaning.
- The shortened spigot enables to install the fan in a the ventilation shaft or to connect to a \varnothing 100 mm air duct.

Control

- Manual control with a room light switch. The switch is not included into the delivery set.
- Automatic control is performed with the humidity sensor or/and timer.
- Selection of the operation mode is performed via changeover of the switch as follows:
 - Operation mode 1:** the fan is turned off by default. The fan switches to the low speed when the switch is closed or to the high speed when the humidity sensor is activated;
 - Operation mode 2:** the fan is turned off by default. The fan switches to the high speed when the switch is closed or the humidity sensor is activated.

Application example



CABRIO BASE V2

SILENT & ENERGY SAVING

Options



Model	Cabrio Base V2 100	
Option	T	H
Timer	•	•
Humidity sensor		•

Timer

- Turn-off delay timer adjustable from 2 to 30 min.
- Turn-on delay timer. Fixed turn-on delay time of 60 sec.
- Interval timer 0, 6, 12 or 24 h.

Humidity sensor

- Humidity setpoint adjustable from 60 % up to 90 %.

Overall dimensions

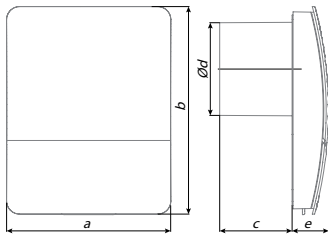

Dimensions [mm]	a	b	c	Ø d	e
Cabrio Base V2 100	175	221	77	99	39

Technical data

Model	Cabrio Base V2 100	
Speed	min.	max.
Voltage [V/Hz]	220-240/50	
Rated power [W]	6	8.5
Current [A]	0.039	0.063
RPM [min ⁻¹]	1850	2400
Air flow [m ³ /h (l/s)]	60 (17)	90 (25)
SFP [W/l/s]	0.36	0.34
Noise level [dBA]	22	25
Weight [kg]	0.55	

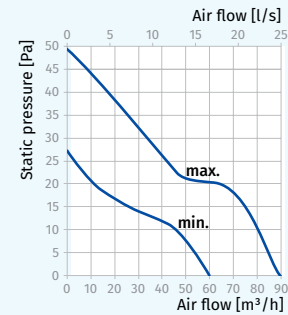

Designation key

Cabrio Base	V2	100	T
Model	Two-speed motor	Spigot diameter	Option

Accessories

Duct system



BlauPlast

Flexible air ducts



BlauFlex

Grilles and hoods



Decor, GM

Speed controllers



CDP-2/5

CDP-2/10

MCD 60/0.3

Clamps



K, KZ

SILEO / SILEO MAX

SILENT & ENERGY SAVING

Features



- Specially designed mixed-flow impeller profile ensures high air flow and low noise level.
- Casing and impeller made of quality durable UV-resistant plastic.
- Backdraft damper for back flow prevention.
- The high ingress protection rating of IP45 makes the fan the ideal solution for the ventilation of bathrooms and shower rooms.
- Low energy demand from 75 W due to a new high-efficient motor.
- The motor is mounted on special anti-vibration dampers.
- The exhaust pipe incorporates a specially designed air rectifier to reduce the air turbulence, increase pressure and lower the noise level.
- **Sileo 150** is equipped with a double-speed motor and **Sileo Max 150** is equipped with a double-speed highpower motor.
- The new automation in the models **Sileo 150** and **Sileo Max 150** enables to set one of five fan operation modes. Changeover to another operation mode is easily performed by setting the DIP switch to a respective position.



Air flow:
up to 375 m³/h
104 l/s



Power:
from 7.5 W
SFP:
from 0.21 W/l/s



Noise level:
from 25 dBA



Options



Model	Sileo 100/125 / Sileo (Max) 150*					
Option	S	T	ST	H	SH	IR
Pull-cord switch	•		•		•	
Timer		•	•	•	•	•
Humidity sensor				•	•	
Motion sensor						•

Timer

- Turn-off delay timer adjustable from 2 to 30 min.
- Turn-on delay timer adjustable from 0 up to 2 min*.

Humidity sensor

- Humidity setpoint adjustable from 60 % up to 90 %.
- Turn-off delay adjustable from 2 up to 30 min.
- Turn-on delay adjustable from 0 up to 2 min*.

Motion sensor

- Detection range from 1 up to 4 m.
- Detection angle up to 100°.
- Turn-off delay adjustable from 2 up to 30 min.
- Turn-on delay adjustable from 0 up to 2 min*.

* Turn-on delay timer is available for models Sileo 150 / Sileo Max 150

Overall dimensions

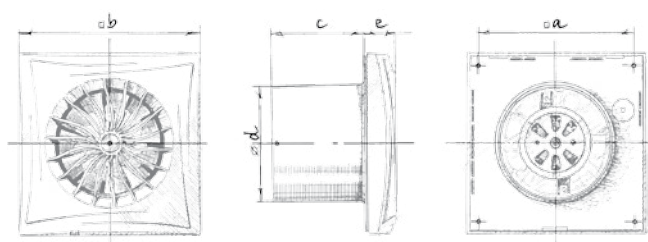

Dimensions [mm]	a	b	c	Ø d	e
Sileo 100	136	158	81	100	26
Sileo 125	158	182	91	124	27
Sileo 150	190	214	98	148	32

Technical data

Model	Sileo 100	Sileo 125	Sileo 150		Sileo Max 150	
			min	max	min	max
Speed						
Voltage [V/Hz]	230/50	230/50	230/50		230/50	
Power [W]	7.5	17	17	19	19	22
Current [A]	0.049	0.11	0.08	0.09	0.09	0.1
Air flow [m ³ /h (l/s)]	97 (27)	187 (52)	225 (63)	318 (88)	283 (79)	375 (104)
SFP [W/l/s]	0.28	0.33	0.27	0.22	0.24	0.21
Noise level [dBA]	25	32	28	33	32	38

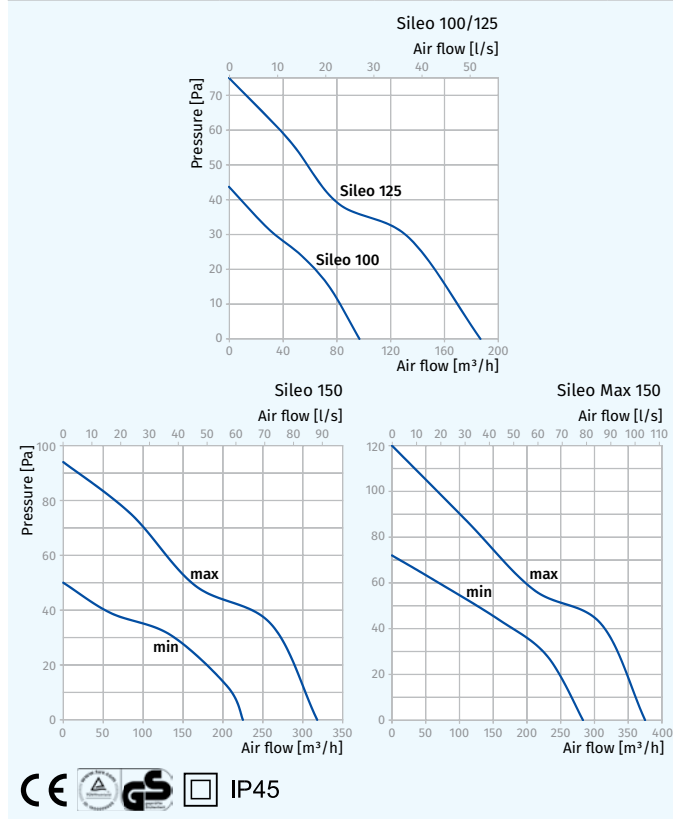

Designation key

Sileo	Max	150	ST
Model	High-powered motor	Spigot diameter	Option

Accessories

Duct system



BlauPlast

Flexible air ducts



BlauFlex

Grilles and hoods



Decor, GM

Speed controllers



CDT E1.8 MCD 60/0.3

Clamps



K, KZ

SILEO V2

SILENT & ENERGY SAVING

Features



- o Specially designed mixed-flow impeller profile ensures high air flow and low noise level.
- o Casing and impeller are made of quality durable UV-resistant plastic.
- o Backdraft damper for back flow prevention.
- o The high ingress protection rating of IP45 makes the fan the ideal solution for the ventilation of bathrooms and shower rooms.
- o The motor is mounted on special anti-vibration dampers.
- o The exhaust pipe incorporates a specially designed air rectifier to reduce the air turbulence, increase pressure and lower the noise level.
- o Ideal for intermittent or continuous ventilation.



Air flow:
up to 170 m³/h
47 l/s



Power:
from 4.5 W
SFP:
from 0.24 W/l/s



Noise level:
from 22 dBA



Options



Model	Sileo V2 100/125		
Option	S	T	H
Pull-cord switch	•		
Interval timer		•	
Turn-on delay timer		•	•
Turn-off delay timer		•	•
Humidity sensor			•

- o **Turn-on delay timer**
 - Fixed turn-on delay time of 60 sec.
- o **Turn-off delay timer**
 - Turn-off delay timer adjustable from 2 to 30 min.
- o **Interval timer**
 - If the interval timer is enabled, the fan will turn on automatically each 6, 12 or 24 hours and it will operate from 2 to 30 min, depending of turn-off delay timer setting.
- o **Humidity sensor**
 - Humidity setpoint adjustable from 60 % up to 90 %.

Overall dimensions

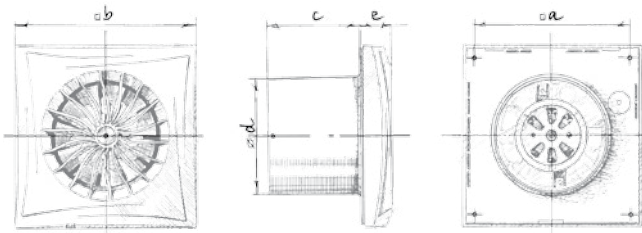

Dimensions [mm]	a	b	c	Ø d	e
Sileo V2 100	136	158	81	100	26
Sileo V2 125	168	182	91	124	27

Designation key

Sileo	V2	125	H
Model	Two-speed motor	Spigot diameter	Option

Technical data

Model	Sileo V2 100		Sileo V2 125	
	min	max	min	max
Speed				
Voltage [V/Hz]	220-240/50			
Power [W]	4.5	7	9.5	13.5
Current [A]	0.029	0.052	0.065	0.09
RPM [min ⁻¹]	1850	2400	1800	2250
Air flow [m ³ /h (l/s)]	60 (17)	90 (25)	145 (40)	170 (47)
SFP [W/l/s]	0.27	0.28	0.24	0.29
Noise level [dBA]	22	25	28	32

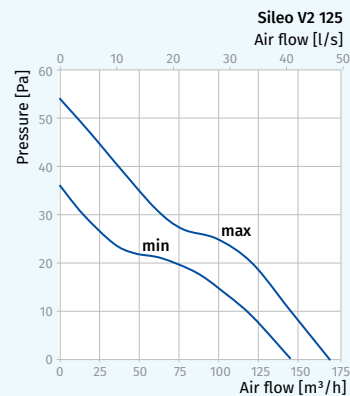
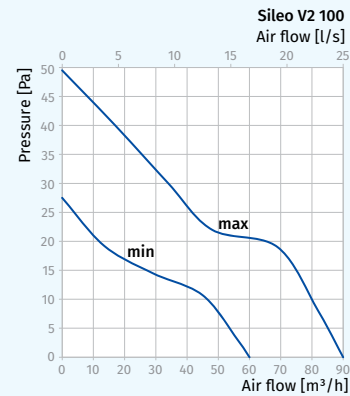

Accessories

Duct system	Flexible air ducts	Grilles and hoods	Speed controllers	Clamps
BlauPlast	BlauFlex	Decor, GM	CDP-2/10	K, KZ

SILEO DC

SILENT & ENERGY SAVING

High-performance
low noise extract fans
with energy-efficient DC motors



Air flow:
up to 101 m³/h
28 l/s



Power:
from 1.5 W
SFP:
from 0.08 W/l/s



Noise level:
from 22 dBA



Features



- The casing and the impeller are made of highquality and durable UV-resistant plastic.
- The specially designed aerodynamic profile of the mixed-flow impeller provides high air flow and pressure combined with low-noise operation.
- A shortened spigot for mounting into a ventilation shaft or direct connection to Ø 100 mm air duct.
- The fan is equipped with a specially designed backdraft damper to prevent back flow and heat losses during the fan standby.
- The fan exhaust spigot incorporates specially designed air rectifiers to reduce air turbulence, noise level and boost air pressure.
- High ingress protection rating makes the fan the ideal solution for ventilation of a bathroom.
- The electronic components are protected with tight covers.

Options



Model	Sileo DC 100		
Option	T	H	IR
Turn-off delay timer	•	•	•
Humidity sensor		•	
Motion sensor			•

- **Turn-off delay timer**
 - Turn-off delay adjustable from 2 up to 30 min.
- **Humidity sensor**
 - Humidity setpoint adjustable from 60 % up to 90 %.
- **Motion sensor**
 - Detection range from 1 up to 4 m.
 - Detection angle up to 100°.

Operating mode

Operation mode selection and setup for Sileo DC 100 models with modifications T, H, IR is performed by setting the DIP switch to a respective position.

MODE 1 (SINGLE-SPEED MODE)

- The fan is turned off by default. The fan starts operating at the low speed when the switch is closed or one of the sensors is activated.

MODE 2 (SINGLE-SPEED MODE)

- The fan is turned off by default. The fan starts operating at the high speed when the switch is closed or one of the sensors is activated.

MODE 3 (TWO-SPEED MODE)

- The fan operates at the low speed by default. The fan switches to the high speed when the switch is closed or the sensors are activated.

MODE 4 (TWO-SPEED MODE)

- The fan is turned off by default. The fan starts operating at the low speed when the switch is closed and switches to the high speed when the humidity or motion sensor is activated.

Motor

- Low energy demand up to 3.5 W due to a new high-efficient DC motor.
- Maintenance-free bearings contain enough grease for 40 000 hrs non-stop operation.
- Motor equipped with electric overheating protection.

Accessories

Duct system



BlauPlast

Flexible air ducts



BlauFlex

Grilles and hoods



Decor, GM

Clamps



K, KZ

Overall and mounting dimensions

- o Direct installation into a ventilation shaft.
- o Flexible air ducts may be used in case of remote location of the ventilation shaft. The air duct is connected to the exhaust spigot with a fixing clamp.
- o Wall mounting with screws.
- o Suitable for ceiling mounting.

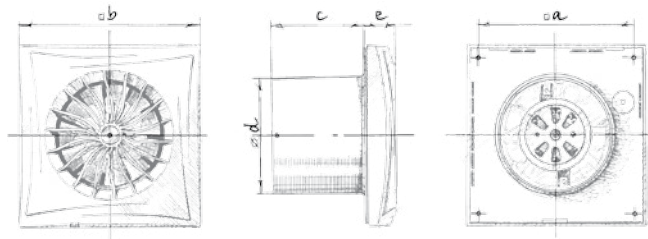

Dimensions [mm]	a	b	c	Ø d	e
Sileo DC 100	136	158	81	100	26

Technical data

Model	Sileo DC 100	
	min	max
Speed		
Voltage [V/Hz]	230/50	
Power [W]	1.5	3.5
Current [A]	0.063	0.137
RPM [min ⁻¹]	1850	2650
Air flow [m ³ /h (l/s)]	70 (19)	101 (28)
SFP [W/l/s]	0.08	0.12
Noise level [dBA]	22	27

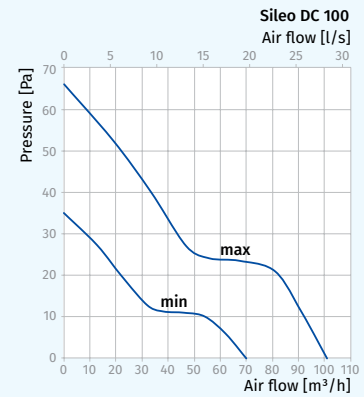

Designation key

Sileo	DC	100	T
Model	Direct current motor	Spigot diameter	Option

SILEO DESIGN

SILENT & ENERGY SAVING

Features



- Specially designed mixed-flow impeller profile ensures high air flow and low noise level.
- Casing and impeller made of quality durable UV-resistant plastic.
- Backdraft damper for back flow prevention.
- The high ingress protection rating of IP45 makes the fan the ideal solution for the ventilation of bathrooms and shower rooms.
- Low energy demand from 75 W due to a new high-efficient motor.
- The motor is mounted on special anti-vibration dampers.
- The exhaust pipe incorporates a specially designed air rectifier to reduce the air turbulence, increase pressure and lower the noise level.



Air flow:
up to 90 m³/h
25 l/s



Power:
from 7.5 W
SFP:
from 0.30 W/l/s



Noise level:
from 26 dB(A)

NEW



Options



Model	Sileo Design 100				
	S	T	ST	H	SH
Option					
Pull-cord switch	•		•		•
Timer		•	•	•	•
Humidity sensor				•	•

- **Timer**
 - Turn-off delay timer adjustable from 2 to 30 min.
- **Humidity sensor**
 - Humidity setpoint adjustable from 60 % up to 90 %.

Overall dimensions and mounting

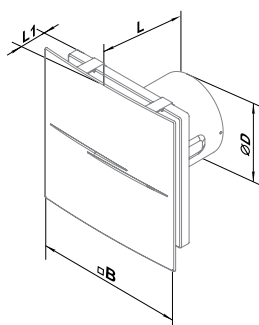

Размеры, мм	Ø D	B	L	L1
Sileo Design 100	99	200	130	49

- Installation directly inside a ventilation shaft.
- Flexible air ducts may be used in case of remote location of the ventilation shaft. Connection of the air duct to the exhaust flange with a clamp.
- Wall mounting with screws.
- Suitable for ceiling mounting.

Technical data

Model	Sileo Design 100
Voltage [V/Hz]	220-240/50(60)
Power [W]	7.5
Current [A]	0.050
RPM [min ⁻¹]	2165
Air flow [m ³ /h (l/s)]	90 (25)
SFP [W/l/s]	0.30
Noise level [dB(A)]	26

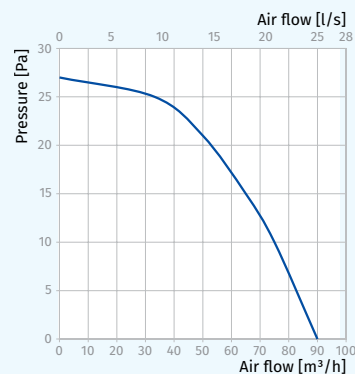

Designation key

Sileo Design	100	H
Model	Spigot diameter	Option

Accessories

Duct system



BlauPlast

Flexible air ducts



BlauFlex

Grilles and hoods



Decor, GM

Speed controls



MCD 60/0.3

Clamps



K, KZ

SILEO DESIGN V2

SILENT & ENERGY SAVING

Features



- o Double-speed fan with air capacity up to 90 m³/h
- o Specially designed mixed-flow impeller profile ensures high air capacity and low noise level.
- o Casing and impeller are made of quality durable UV-resistant plastic.
- o Backdraft damper for back flow prevention.
- o The high ingress protection rating of IP45 makes the fan the ideal solution for the ventilation of bathrooms and shower rooms.
- o The motor is mounted on special anti-vibration dampers.
- o The exhaust pipe incorporates a specially designed air rectifier to reduce the air turbulence, increase pressure and lower the noise level.
- o Ideal for intermittent or continuous ventilation.



Air flow:
up to 90 m³/h
25 l/s



Power:
from 4.5 W
SFP:
from 0.27 W/l/s



Noise level:
from 22 dB(A)

NEW



Options



Model	Sileo Design V2 100		
	S	T	H
Pull-cord switch	•		
Interval timer		•	
Turn-on delay timer		•	•
Turn-off delay timer		•	•
Humidity sensor			•

- o **Turn-on delay timer**
 - Fixed turn-on delay time of 60 sec.
- o **Turn-off delay timer**
 - Turn-off delay timer adjustable from 2 to 30 min.
- o **Interval timer**
 - If the interval timer is enabled, the fan will turn on automatically each 6, 12 of 24 hrs, and it will operate from 2 to 30 min, depending of turn-off delay timer setting.
- o **Humidity sensor**
 - Humidity setpoint adjustable from 60 % up to 90 %.

Overall dimensions

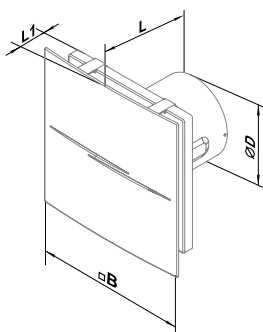

Dimensions [mm]	Ø D	B	L	L1
Sileo Design V2 100	99	200	130	49

Technical data

Model	Sileo Design V2 100	
	min	max
Voltage [V/Hz]	220-240/50	
Power [W]	4.5	7
Current [A]	0.029	0.052
RPM [min ⁻¹]	1850	2400
Air flow [m ³ /h (l/s)]	60 (17)	90 (25)
SFP [W/l/s]	0.27	0.28
Noise level [dB(A)]	22	25

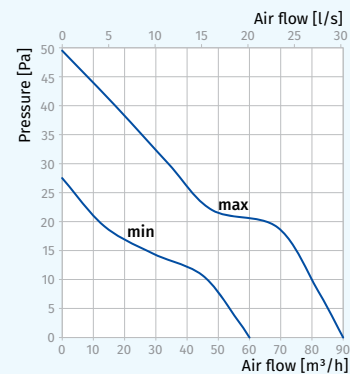

Designation key

Sileo Design	V2	100	H
Model	Two-speed motor	Spigot diameter	Option

Accessories

Duct system



BlauPlast

Flexible air ducts



BlauFlex

Grilles and hoods



Decor, GM

Speed controls



CDP-2/10

Clamps



K, KZ

AERO STILL

SILENT & ENERGY SAVING

Features



- Wall and ceiling mounting
- Low energy consumption and noise
- Easy maintenance
- Continuous operation
- Backdraft damper
- Ball bearing motor
- Available in chrome (Aero Chrome) and gold (Aero Gold) decorations
- 5 year warranty



Air flow:
up to 254 m³/h
71 l/s



Power:
from 5.5 W
SFP:
from 0.21 W/l/s



Noise level:
from 25 dBA



Gold



Chrome



Vintage

Options



Model	Aero Still 100/125/150				
	S	T	ST	H	SH
Option					
Pull-cord switch	•		•		•
Timer		•	•	•	•
Humidity sensor				•	•

- Turn-off delay adjustable from 2 to 30 min.
- Humidity setpoint adjustable from 60 % up to 90 %.

Overall dimensions and mounting

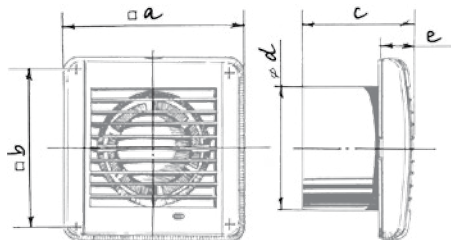

Dimensions [mm]	a	b	c	∅ d	e
Aero Still 100	144	122	92.5	100	29.5
Aero Still 125	168	144	97	125	30
Aero Still 150	198	170	119	150	30

Technical data

Model	Aero Still 100	Aero Still 125	Aero Still 150
Voltage [V/Hz]	220-240/50	220-240/50	220-240/50
Power [W]	5.5	9.4	19
Current [A]	0.035	0.059	0.14
Air flow [m ³ /h (l/s)]	84 (23)	158 (44)	254 (71)
SFP [W/l/s]	0.24	0.21	0.27
Noise level [dBA]	25	31	33

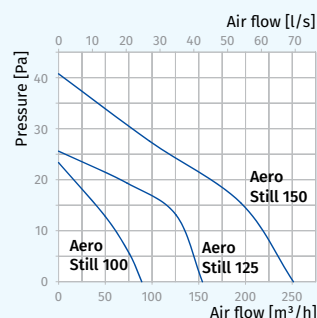

Designation key

Aero	Still	Gold	125	SH
Model	Silent	Color	Spigot diameter	Option

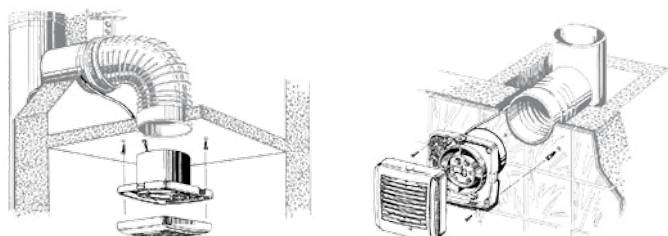

Accessories

Duct system	Flexible air ducts	Grilles and hoods	Speed controllers	Clamps
BlauPlast	BlauFlex	Decor, GM	CDT E1.8 MCD 60/0.3	K, KZ

BRAVO STILL

SILENT & ENERGY SAVING

Features



- o Wall and ceiling mounting
- o Easy maintenance
- o Continuous operation
- o Backdraft damper
- o Ball bearing motor
- o Available in chrome (Bravo Still Chrome) and platinum (Bravo Still Platinum) decorations
- o 5 year warranty



Air flow:
up to 235 m³/h
65 l/s



Power:
from 5.6 W
SFP:
from 0.29 W/l/s



Noise level:
from 26 dBA



Chrome



Platinum

Options



Model	Bravo Still 100/125/150					
Option	S	T	ST	H	SH	IR
Pull-cord switch	•		•		•	
Timer		•	•	•	•	•
Humidity sensor				•	•	
Motion sensor						•

- o Turn-off delay adjustable from 2 to 30 min.
- o Humidity setpoint adjustable from 60 % up to 90 %.
- o Detection range from 1 up to 4 m.
- o Detection angle up to 100°.

Technical data

Model	Bravo Still 100	Bravo Still 125	Bravo Still 150
Voltage [V/Hz]	220-240/50	220-240/50	220-240/50
Power [W]	5.6	9.3	20
Current [A]	0.04	0.006	0.13
Air flow [m ³ /h (l/s)]	70 (19)	115 (32)	235 (65)
SFP [W/l/s]	0.29	0.29	0.31
Noise level [dBA]	26	31	35

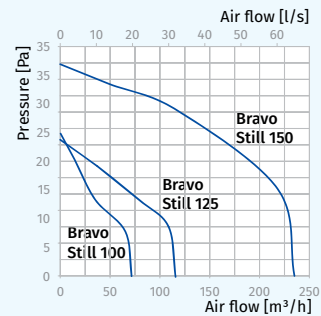

Overall dimensions and mounting

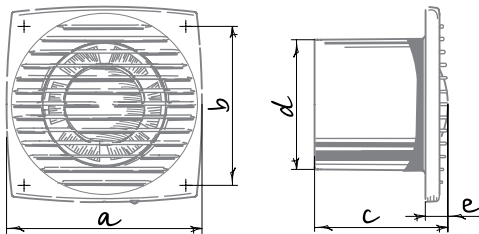

Dimensions [mm]	a	b	c	Ø d	e
Bravo Still 100	150	122	102	100	17
Bravo Still 125	176	144	104	125	17
Bravo Still 150	205	174	124	150	19

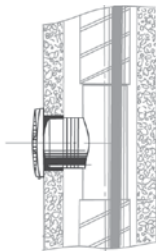

Designation key

Bravo	Still	Chrome	100	S
Model	Low-noise application	Color	Spigot diameter	Option

Accessories

Duct system



BlauPlast

Flexible air ducts



BlauFlex

Grilles and hoods



Decor, GM

Speed controllers



CDT E1.8

MCD 60/0.3

Clamps



K, KZ

AUTO

CLASSIC MODELS

Features



- Wall mounting
- Easy maintenance
- Continuous operation
- Automatic shutters
- Ball bearing motor
- 5 year warranty



Air flow:
up to 295 m³/h
82 l/s



Power:
from 18 W
SFP:
from 0.32 W/l/s



Noise level:
from 34 dBA



Options



Model	Auto 100/125/150					
Option	S	T	ST	H	SH	IR
Pull-cord switch	•		•		•	
Timer		•	•	•	•	
Humidity sensor				•	•	
Motion sensor						•

- Turn-off delay adjustable from 2 to 30 min.
- Humidity setpoint adjustable from 60 % up to 90 %.
- Detection range from 1 up to 4 m.
- Detection angle up to 100°.

Overall dimensions and mounting

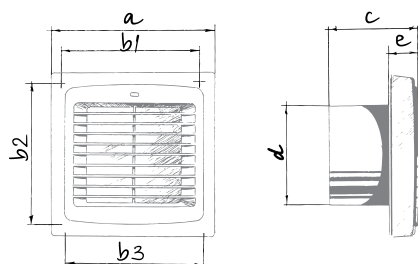

Dimensions [mm]	a	b1	b2	b3	c	Ø d	e
Auto 100	166	150	150	150	90	100	30
Auto 125	186	128	173	174	98	125	33
Auto 150	210	150	195	196	115	150	34

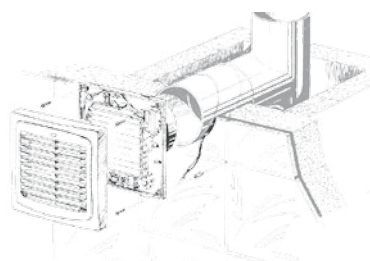

Technical data

Model	Auto 100	Auto 125	Auto 150
Voltage [V/Hz]	220-240/50	220-240/50	220-240/50
Power [W]	18	22	26
Current [A]	0.085	0.1	0.13
RPM [min ⁻¹]	2300	2400	2400
Air flow [m ³ /h (l/s)]	98 (27)	185 (51)	295 (82)
SFP [W/l/s]	0.66	0.43	0.32
Noise level [dBA]	34	35	39

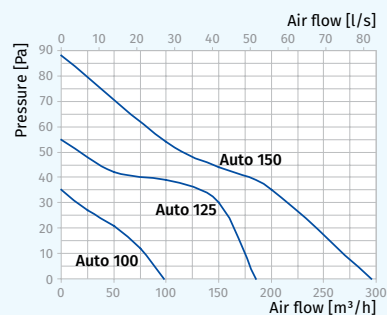

Designation key

Auto	100	ST
Model	Spigot diameter	Option

Accessories

Duct system



BlauPlast

Flexible air ducts



BlauFlex

Grilles and hoods



Decor, GM

Speed controllers



CDT E1.8 MCD 60/0.3

Clamps



K, KZ

AUTO REVERS

CLASSIC MODELS

Features



- o Wall and ceiling mounting
- o Low-noise impeller
- o Easy maintenance
- o Continuous operation
- o Automatic shutters
- o Reliable DC motor (12 V) with low energy demand
- o Supplied with a three bottom control unit and 220 V - 12 V transformer
- o 5 year warranty



Air flow:
up to 202 m³/h
56 l/s



Power:
from 5.1 W
SFP:
from 0.15 W/l/s



Noise level:
from 26 dBA



Control

- o Manual:
Three bottom control unit (included into delivery set):

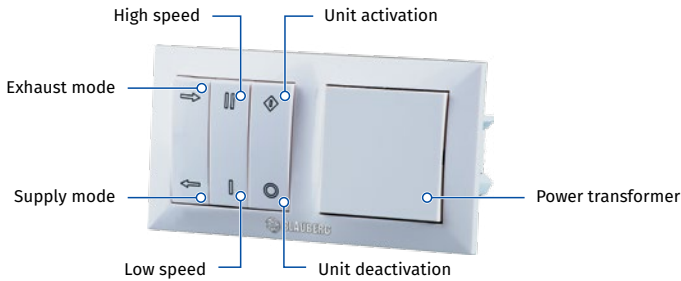

Technical data

Auto Revers 150	Exhaust mode		Supply mode	
	min	max	min	max
Speed				
Voltage [V/Hz]	220-240/50		220-240/50	
Power [W]	5.2	8.7	5.1	7.6
Current [A]	0.025	0.045	0.025	0.045
RPM [min ⁻¹]	1215	1950	1210	2030
Air flow [m ³ /h (l/s)]	123 (34)	202 (56)	110 (31)	187 (52)
SFP [W/l/s]	0.15	0.16	0.17	0.15
Noise level [dBA]	28	33	26	32

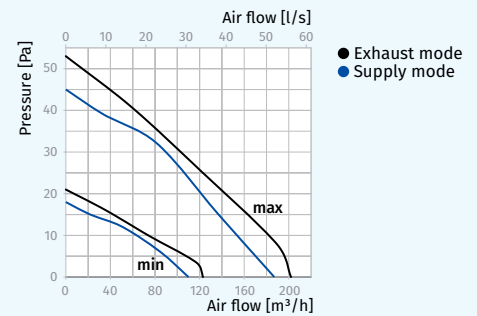

Overall dimensions and mounting

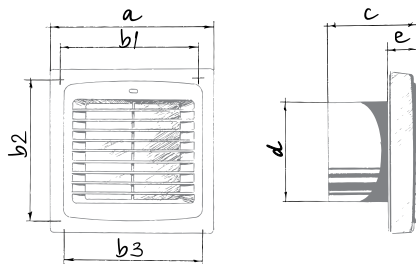

Dimensions [mm]	a	b1	b2	b3	c	Ø d	e
Auto Revers 150	212	150	195	196	114	150	33

- o Fan is designed for indoor mounting on the external wall and is connected to the air duct.
- o Fixation to the wall or ceiling with screws. Flexible air duct is connected to exhaust flange with a clamp.

Accessories

Duct system	Flexible air ducts	Grilles and hoods	Clamps
BlauPlast	BlauFlex	Decor, GM	K, KZ

AERO

CLASSIC MODELS

Features



- Wall and ceiling mounting.
- **Blauberg Aero Bivolt** series models are equipped with specially designed motors compatible with both 127 V and 220 V power mains.
- Easy maintenance.
- Continuous operation.
- Backdraft damper.
- Ball bearing motor.
- Available in chrome (Aero Chrome) and gold (Aero Gold) decorations.
- 5 year warranty.



Air flow:
up to 309 m³/h
86 l/s



Power:
from 14 W
SFP:
from 0.28 W/l/s



Noise level:
from 38 dBA



Gold



Chrome



Vintage

Options



Model	Aero 100/125/150				
	S	T	ST	H	SH
Pull-cord switch	•		•		•
Timer		•	•	•	•
Humidity sensor				•	•

- Turn-off delay adjustable from 2 to 30 min.
- Humidity setpoint adjustable from 60 % up to 90 %.

Overall dimensions and mounting

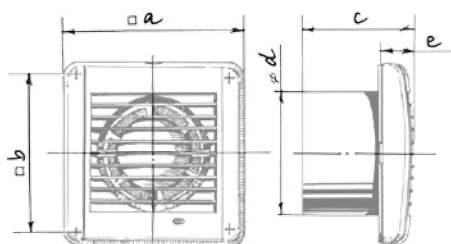

Dimensions [mm]	a	b	c	∅ d	e
Aero 100	144	122	92.5	100	29.5
Aero 125	168	144	97	125	30
Aero 150	198	170	119	150	30

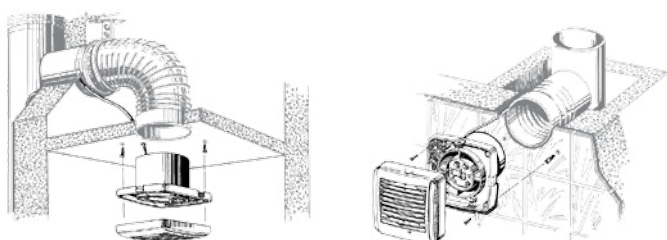

Designation key

Aero	Gold	100	S	Bivolt
Model	Color	Spigot diameter	Option	Voltage

Technical data

Model	Aero 100	Aero 125	Aero 150
Voltage [V/Hz]	220-240/50	220-240/50	220-240/50
Power [W]	14	16	24
Current [A]	0.085	0.1	0.13
RPM [min ⁻¹]	2300	2400	2400
Air flow [m ³ /h (l/s)]	102 (28)	193 (54)	309 (86)
SFP [W/l/s]	0.49	0.3	0.28
Noise level [dBA]	38	39	40

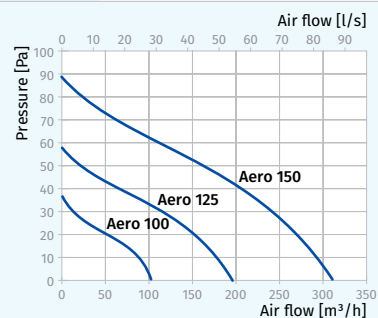

Model	Aero 100 Bivolt	Aero 125 Bivolt	Aero 150 Bivolt
Voltage [V/Hz]	127/60 220/60	127/60 220/60	127/60 220/60
Power [W]	10	9	16
Current [A]	0.115	0.054	0.119
RPM [min ⁻¹]	2500	2500	2400
Air flow [m ³ /h (l/s)]	92 (26)	92 (26)	190 (53)
SFP [W/l/s]	0.39	0.35	0.30
Noise level [dBA]	34	34	36

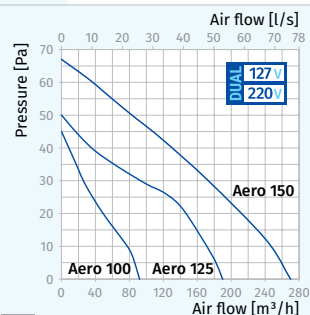

Accessories

Duct system



BlauPlast

Flexible air ducts



BlauFlex

Grilles and hoods



Decor, GM

Speed controllers



CDT E1.8

MCD 60/0.3

Clamps



K, KZ

BRAVO

CLASSIC MODELS

Features



- Wall and ceiling mounting
- Low-noise impeller
- Easy maintenance
- Continuous operation
- Backdraft damper
- Ball bearing motor
- Available in chrome (Bravo Chrome) and platinum (Bravo Platinum) decorations
- 5 year warranty



Air flow:
up to 305 m³/h
85 l/s



Power:
from 14 W
SFP:
from 0.28 W/l/s



Noise level:
from 35 dBA



Chrome



Platinum

Options



Model	Bravo 100/125/150					
	S	T	ST	H	SH	IR
Option						
Pull-cord switch	•		•		•	
Timer		•	•	•	•	
Humidity sensor				•	•	
Motion sensor						•

- Turn-off delay adjustable from 2 to 30 min.
- Humidity setpoint adjustable from 60 % up to 90 %.
- Detection range from 1 up to 4 m.
- Detection angle up to 100°.

Overall dimensions and mounting

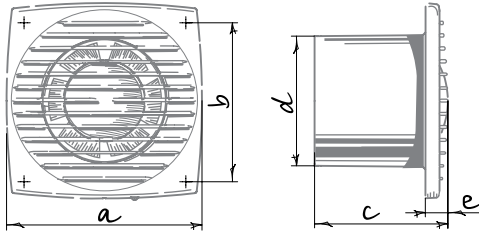

Dimensions [mm]	a	b	c	∅ d	e
Bravo 100	150	122	102	100	17
Bravo 125	176	144	104	125	17
Bravo 150	205	174	124	150	19

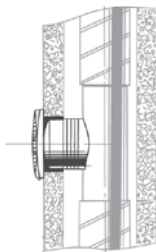

Designation key

Bravo	Chrome	100	S	Bivolt
Model	Color	Spigot diameter	Option	Voltage

Technical data

Model	Bravo 100	Bravo 125	Bravo 150
Voltage [V/Hz]	220-240/50	220-240/50	220-240/50
Power [W]	14	16	24
Current [A]	0.085	0.1	0.13
RPM [min ⁻¹]	2300	2400	2400
Air flow [m ³ /h (l/s)]	101 (28)	192 (53)	305 (85)
SFP [W/l/s]	0.5	0.3	0.28
Noise level [dBA]	35	37	39

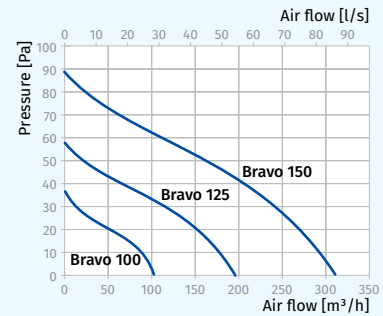

Model	Bravo 100 Bivolt	Bravo 125 Bivolt	Bravo 150 Bivolt			
Voltage [V/Hz]	127/60	220/60	127/60	220/60	127/60	220/60
Power [W]	10	9	16	15	25	25
Current [A]	0.115	0.054	0.119	0.102	0.175	0.338
RPM [min ⁻¹]	2500	2500	2400	2400	2350	2350
Air flow [m ³ /h (l/s)]	91 (25)	91 (25)	189 (53)	189 (53)	266 (74)	266 (74)
SFP [W/l/s]	0.4	0.36	0.3	0.29	0.34	0.34
Noise level [dBA]	33	33	34	34	38	38

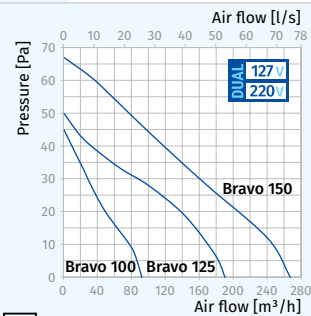

Accessories

Duct system	Flexible air ducts	Grilles and hoods	Speed controllers	Clamps
BlauPlast	BlauFlex	Decor, GM	CDT E1.8	MCD 60/0.3

SLIM

CLASSIC MODELS

Features



- o Specially designed for extract ventilation
- o Wall and ceiling mounting
- o Easy installation and maintenance
- o Continuous operation
- o Backdraft damper
- o Ball bearing motor



Air flow:
up to 305 m³/h
85 l/s



Power:
from 14 W
SFP:
from 0.28 W/l/s



Noise level:
from 33 dBA



Options



Model	Slim 100/125/150				
	S	T	ST	H	SH
Option					
Pull-cord switch	•		•		•
Timer		•	•	•	•
Humidity sensor				•	•

- o Turn-off delay adjustable from 2 to 30 min.
- o Humidity setpoint adjustable from 60 % up to 90 %.

Overall dimensions and mounting

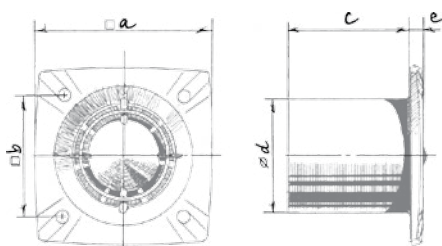

Dimensions [mm]	a	b	c	∅ d	e
Slim 100	150	120	111	100	15.7
Slim 125	176	140	115	125	14.5
Slim 150	205	165	134	150	16

Technical data

Model	Slim 100	Slim 125	Slim 150
Voltage [V/Hz]	220-240/50	220-240/50	220-240/50
Power [W]	14	16	24
Current [A]	0.085	0.1	0.13
Air flow [m ³ /h (l/s)]	105 (29)	190 (53)	305 (85)
SFP [W/l/s]	0.48	0.3	0.28
Noise level [dBA]	33	34	37

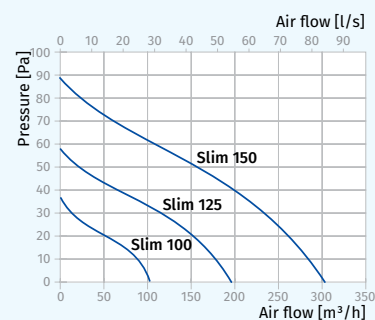

Designation key

Slim	100	SH
Model	Spigot diameter	Option

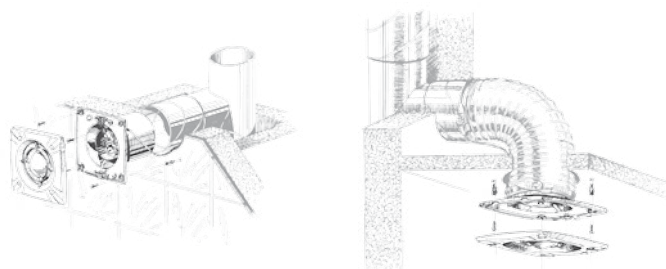

Accessories

Duct system



BlauPlast

Flexible air ducts



BlauFlex

Grilles and hoods



Decor, GM

Speed controllers



CDT E1.8

MCD 60/0.3

Clamps



K, KZ

LINE

CLASSIC MODELS

Features



- o For exhaust ventilation of residential premises
- o Wall surface or ceiling mounting
- o Low-noise impeller
- o Easy maintenance
- o Continuous operation
- o Backdraft damper
- o Ball bearing motor



Air flow:
up to 292 m³/h
81 l/s



Power:
from 14 W
SFP:
from 0.3 W/l/s



Noise level:
from 34 dBA



Options



Model	Line 100/125/150				
	S	T	ST	H	SH
Option					
Pull-cord switch	•		•		•
Timer		•	•	•	•
Humidity sensor				•	•

- o Turn-off delay adjustable from 2 to 30 min.
- o Humidity setpoint adjustable from 60 % up to 90 %.

Technical data

Model	Line 100	Line 125	Line 150
Voltage [V/Hz]	220-240/50	220-240/50	220-240/50
Power [W]	14	16	24
Current [A]	0.085	0.1	0.13
RPM [min ⁻¹]	2300	2400	2400
Air flow [m ³ /h (l/s)]	95 (26)	180 (50)	292 (81)
SFP [W/l/s]	0.53	0.32	0.3
Noise level [dBA]	34	35	38

Overall dimensions and mounting

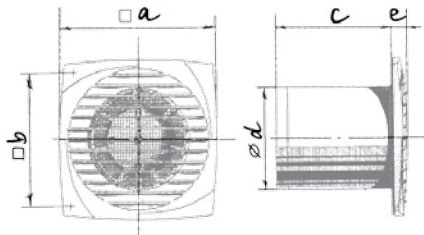

Dimensions [mm]	a	b	c	∅ d	e
Line 100	150	120	108.5	100	12.5
Line 125	176	140	114	125	12.5
Line 150	205	165	132	150	13

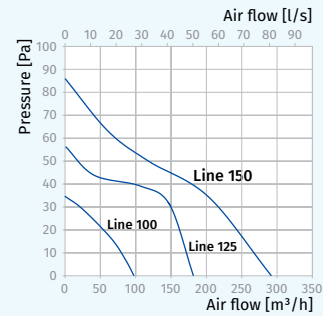

Designation key

Line	100	S
Model	Spigot diameter	Option

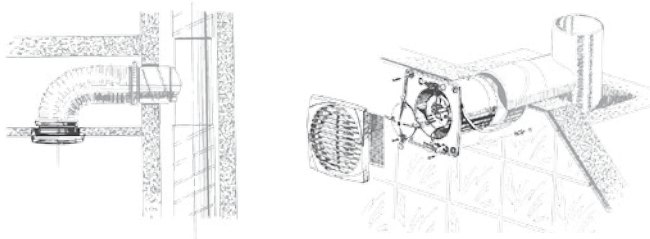

Accessories

Duct system



BlauPlast

Flexible air ducts



BlauFlex

Grilles and hoods



Decor, GM

Speed controllers



CDT E1.8

MCD 60/0.3

Clamps



K, KZ

JET

CLASSIC MODELS

Features



- Wall and ceiling mounting
- Ball bearing motor
- Easy mounting with the help of locking tabs or screws
- Light indication for fan operation
- Modern design
- Available in aluminium decoration (Jet Hi-Tech)
- 5 year warranty



Air flow:
95 m³/h
26 l/s



Power:
14 W
SFP:
0.53 W/l/s



Noise level:
34 dBA



Jet Hi-Tech

Options



Model	Jet 100	
Option	T	H
Timer	•	•
Humidity sensor		•

- Turn-off delay adjustable from 2 to 30 min.
- Humidity setpoint adjustable from 60 % up to 90 %.

Overall dimensions and mounting

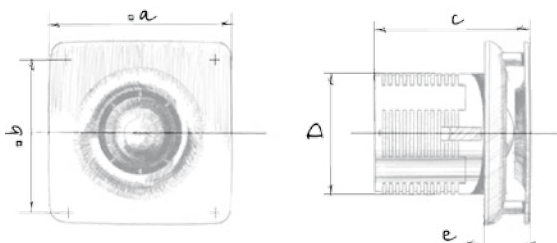

Dimensions [mm]	a	b	c	∅ d	e
Jet 100	150	122	125	98	36

Technical data

Model	Jet 100
Voltage [V/Hz]	220-240/50
Power [W]	14
Current [A]	0.085
RPM [min ⁻¹]	2300
Air flow [m ³ /h (l/s)]	95 (26)
SFP [W/l/s]	0.53
Noise level [dBA]	34

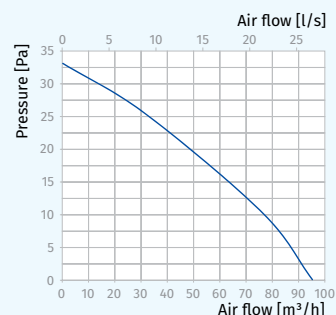

Designation key

Jet	Hi-Tech	100	H
Model	Color	Spigot diameter	Option

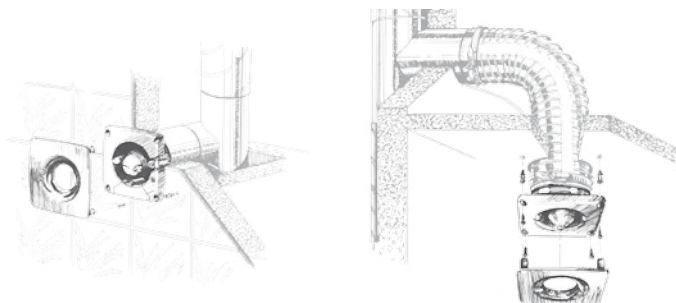

Accessories

Duct system



BlauPlast

Flexible air ducts



BlauFlex

Grilles and hoods



Decor, GM

Speed controllers



CDT E1.8

MCD 60/0.3

Clamps



K, KZ

DECO

CLASSIC MODELS

Features



- o Wall and ceiling mounting
- o Low-noise impeller
- o Easy maintenance
- o Continuous operation
- o Backdraft damper
- o Ball bearing motor
- o 5 year warranty



Air flow:
up to 298 m³/h
83 l/s



Power:
from 14 W
SFP:
from 0.29 W/l/s



Noise level:
from 37 dBA



Options



Model	Deco 100/125/150
Option	T
Timer	•

- o Turn-off delay adjustable from 2 to 30 min.

Overall dimensions and mounting

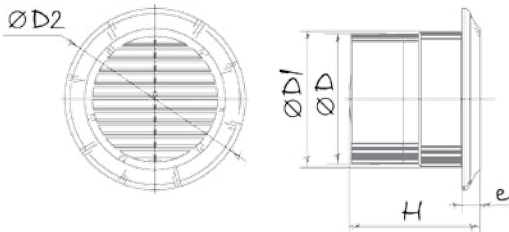

Dimensions [mm]	Ø D	Ø D1	Ø D2	H	e
Deco 100	99.5	104	140	101.5	14
Deco 125	124.5	129	165	107.5	14
Deco 150	149.5	154	188.5	114	14

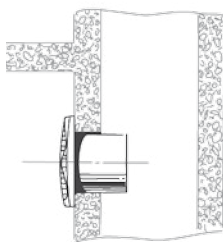

Technical data

Model	Deco 100	Deco 125	Deco 150
Voltage [V/Hz]	220-240/50	220-240/50	220-240/50
Power [W]	14	16	24
Current [A]	0.085	0.1	0.13
RPM [min ⁻¹]	2300	2400	2400
Air flow [m ³ /h (l/s)]	105 (29)	185 (51)	298 (83)
SFP [W/l/s]	0.48	0.31	0.29
Noise level [dBA]	37	38	40

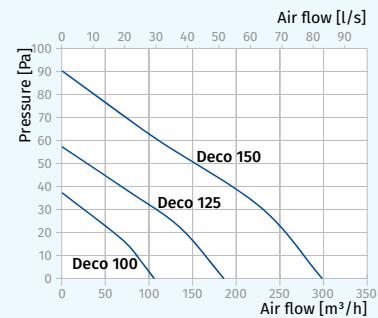

Designation key

Deco	125	T
Model	Spigot diameter	Option

Accessories

Duct system



BlauPlast

Flexible air ducts



BlauFlex

Grilles and hoods



Decor, GM

Speed controllers



CDT E1.8

MCD 60/0.3

Clamps



K, KZ

ART

WITH DECORATIVE FRONT PANEL

Features



- Wall mounting
- Easy maintenance
- Low-noise impeller
- Continuous operation
- Ball bearing motor
- Stainless steel front cover available in 6 options
- 5 year warranty



Air flow:
up to 298 m³/h
83 l/s



Power:
from 14 W
SFP:
from 0.29 W/l/s



Noise level:
from 37 dBA



Overall dimensions

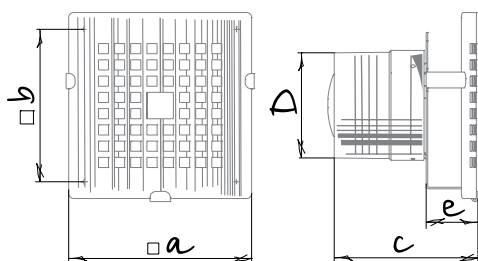

Dimensions [mm]	a	b	c	Ø D	e
Art 100	180	120	142	100	49
Art 125	204	140	147	125	55
Art 150	230	165	155	150	53

Technical data

Model	Art 100	Art 125	Art 150
Voltage [V/Hz]	220-240/50	220-240/50	220-240/50
Power [W]	14	16	24
Current [A]	0.085	0.1	0.13
RPM [min ⁻¹]	2300	2400	2400
Air flow [m ³ /h (l/s)]	105 (29)	185 (51)	298 (83)
SFP [W/l/s]	0.48	0.31	0.29
Noise level [dBA]	37	38	40

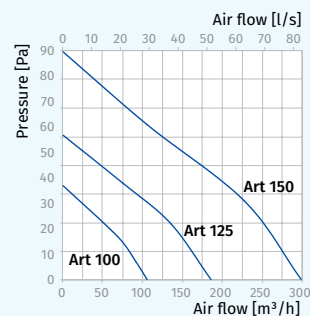

Decorative panels



Art - 1



Art - 2

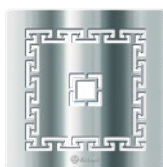

Art - 3



Art - 4



Art - 5



Art - 6

Designation key

Art	-1	100
Model	Panel design	Spigot diameter

Accessories

Duct system



BlauPlast

Flexible air ducts



BlauFlex

Grilles and hoods



Decor, GM

Speed controllers



CDT E1.8

MCD 60/0.3

Clamps



K, KZ

LUX

WITH DECORATIVE FRONT PANEL AND LIGHTING

Features



- o Wall mounting
- o Easy maintenance
- o Low-noise impeller
- o Continuous operation
- o Ball bearing motor
- o Stainless steel front cover
- o Built-in 2W LED-lamp
- o 5 year warranty



Air flow:
up to 258 m³/h
72 l/s



Power:
from 14 W
SFP:
from 0.33 W/l/s



Noise level:
from 33 dBA



Options



Model	Lux 100/125/150	
Option	T	H
Timer	•	•
Humidity sensor		•

- o Turn-off delay adjustable from 2 to 30 min.
- o Humidity setpoint adjustable from 60 % up to 90 %.

Overall dimensions

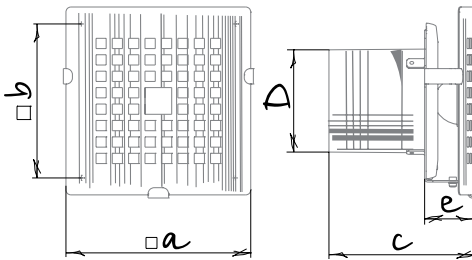

Dimensions [mm]	a	b	c	Ø D	e
Lux 100	180	120	142	100	49
Lux 100 T	182	122	151.6	98	65
Lux 100 H	182	122	151.6	98	65
Lux 125	204	140	152	125	55
Lux 150	230	165	169	150	53

Designation key

Lux	-1	100	T
Model	Panel design	Spigot diameter	Option

Technical data

Model	Lux 100	Lux 125	Lux 150
Voltage [V/Hz]	220-240/50	220-240/50	220-240/50
Power [W]	14	16	24
Current [A]	0.085	0.1	0.13
RPM [min ⁻¹]	2300	2400	2400
Air flow [m ³ /h (l/s)]	89 (25)	164 (46)	258 (72)
SFP [W/l/s]	0.57	0.35	0.33
Noise level [dBA]	33	34	37

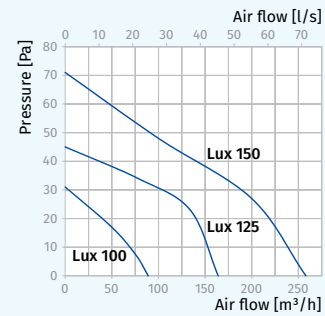

Decorative panels



Lux - 1

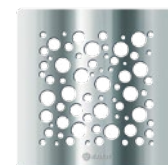

Lux - 2



Lux - 3



Lux - 4

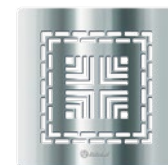

Lux - 5



Lux - 6

Accessories

Duct system



BlauPlast

Flexible air ducts



BlauFlex

Grilles and hoods



Decor, GM

Speed controllers



CDT E1.8

MCD 60/0.3

Clamps



K, KZ

ICE

WITH DECORATIVE FRONT PANEL

Features



- Wall mounting
- Easy maintenance
- Low-noise impeller
- Continuous operation
- Ball bearing motor
- Glass front cover
- 5 year warranty



Air flow:
up to 298 m³/h
83 l/s



Power:
from 14 W
SFP:
from 0.29 W/l/s



Noise level:
from 37 dBA



Overall dimensions

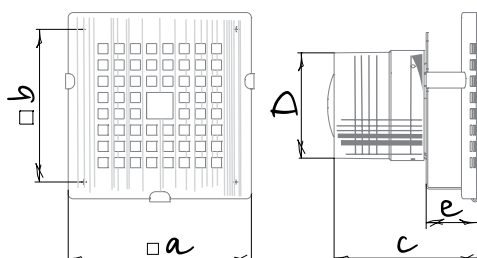

Dimensions [mm]	a	b	c	Ø D	e
Ice 100	183	120	151	100	58
Ice 125	205	140	156	125	58
Ice 150	233	165	173	150	58

Technical data

Model	Ice 100	Ice 125	Ice 150
Voltage [V/Hz]	220-240/50	220-240/50	220-240/50
Power [W]	14	16	24
Current [A]	0.085	0.1	0.13
RPM [min ⁻¹]	2300	2400	2400
Air flow [m ³ /h (l/s)]	105 (29)	185 (51)	298 (83)
SFP [W/l/s]	0.48	0.31	0.29
Noise level [dBA]	37	38	40

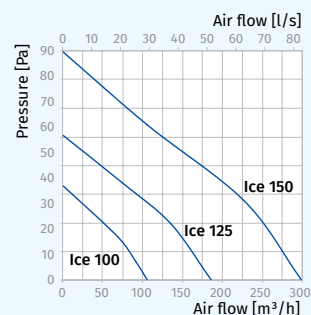

Decorative panels



Ice - 1



Ice - 2



Ice - 3



Ice - 4



Ice - 5



Ice - 6

Designation key

Ice	- 1	100
Model	Panel design	Spigot diameter

Accessories

Duct system



BlauPlast

Flexible air ducts



BlauFlex

Grilles and hoods



Decor, GM

Speed controllers



CDT E1.8

MCD 60/0.3

Clamps



K, KZ

GLORY

WITH DECORATIVE FRONT PANEL AND LIGHTING

Features



- o Wall mounting
- o Easy maintenance
- o Low-noise impeller
- o Continuous operation
- o Ball bearing motor
- o Glass front cover
- o Built-in 2 W LED-lamp
- o 5 year warranty



Air flow:
up to 258 m³/h
72 l/s



Power:
from 14 W
SFP:
from 0.33 W/l/s



Noise level:
from 33 dBA



Options



Model	Glory 100/125/150	
Option	T	H
Timer	•	•
Humidity sensor		•

- o Turn-off delay adjustable from 2 to 30 min.
- o Humidity setpoint adjustable from 60 % up to 90 %.

Overall dimensions

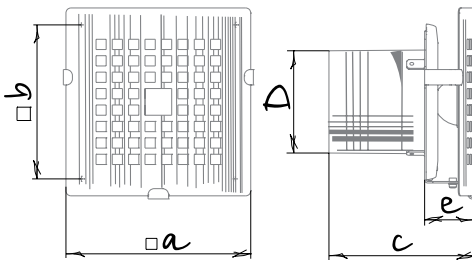

Dimensions [mm]	a	b	c	Ø D	e
Glory 100	180	120	143	100	49
Glory 100 T	183	122	151.6	98	65
Glory 100 H	183	122	151.6	98	65
Glory 125	204	140	152	125	55
Glory 150	230	165	169	150	53

Designation key

Glory	- 1	125	H
Model	Decorative panel	Spigot diameter	Option

Technical data

Model	Glory 100	Glory 125	Glory 150
Voltage [V/Hz]	220-240/50	220-240/50	220-240/50
Power [W]	14	16	24
Current [A]	0.085	0.1	0.13
RPM [min ⁻¹]	2300	2400	2400
Air flow [m ³ /h (l/s)]	89 (25)	164 (46)	258 (72)
SFP [W/l/s]	0.57	0.35	0.33
Noise level [dBA]	33	34	37

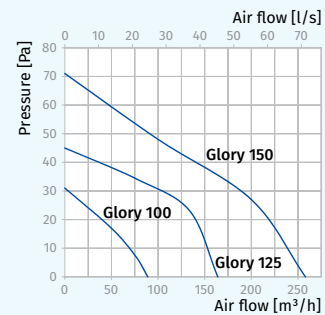

Decorative panels



Glory - 1



Glory - 2



Glory - 3



Glory - 4



Glory - 5



Glory - 6

Accessories

Duct system



BlauPlast

Flexible air ducts



BlauFlex

Grilles and hoods



Decor, GM

Speed controllers



CDT E1.8

MCD 60/0.3

Clamps



K, KZ

QUATRO

WITH DECORATIVE FRONT PANEL

Features



- Wall and ceiling mounting.
- **Blauberg Quatro Bivolt** series models are equipped with specially designed motors compatible with both 127 V and 220 V power mains.
- Easy maintenance.
- Low-noise impeller.
- Continuous operation.
- Backdraft damper.
- Ball bearing motor.
- Available in metallic (Quatro Platinum), aluminium (Quatro Hi-Tech), chrome (Quatro Chrome) and gold (Quatro Gold) decorations.
- 5 year warranty.



Air flow:
up to 265 m³/h
74 l/s



Power:
from 14 W
SFP:
from 0.32 W/l/s



Noise level:
from 33 dBA



Options



Model	Quatro 100/125/150				
Option	S	T	ST	H	SH
Pull-cord switch	•		•		•
Timer		•	•	•	•
Humidity sensor				•	•

- Turn-off delay adjustable from 2 to 30 min.
- Humidity setpoint adjustable from 60 % up to 90 %.

Overall dimensions and mounting

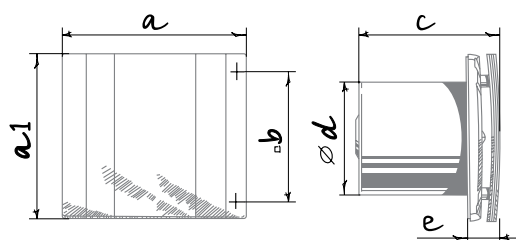

Dimensions [mm]	a	a1	b	c	Ød	e
Quatro 100	171	151	108	128	100	32
Quatro 125	201	178	113	136	125	35
Quatro 150	236	207	165	157	150	38

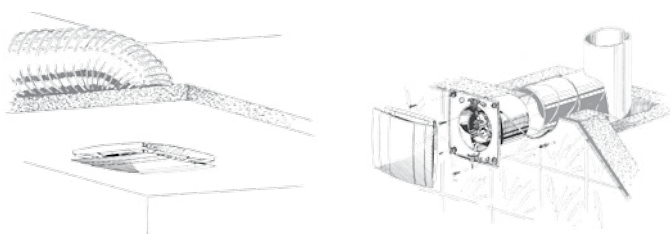

Designation key

Quatro	Platinum	100	S	Bivolt
Model	Color	Spigot diameter	Option	Voltage

Technical data

Model	Quatro 100	Quatro 125	Quatro 150
Voltage [V/Hz]	220-240/50	220-240/50	220-240/50
Power [W]	14	16	24
Current [A]	0.085	0.1	0.13
RPM [min ⁻¹]	2300	2400	2400
Air flow [m ³ /h (l/s)]	88 (24)	167 (46)	265 (74)
SFP [W/l/s]	0.57	0.34	0.33
Noise level [dBA]	33	34	37

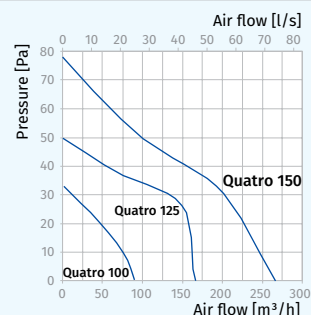

Model	Quatro 100 Bivolt	Quatro 125 Bivolt	Quatro 150 Bivolt
Voltage [V/Hz]	127/60 220/60	127/60 220/60	127/60 220/60
Power [W]	10 9	16 15	25 25
Current [A]	0.115 0.054	0.119 0.102	0.175 0.338
RPM [min ⁻¹]	2500 2500	2400 2400	2350 2350
Air flow [m ³ /h (l/s)]	82 (23) 82 (23)	170 (47) 170 (47)	240 (67) 240 (67)
SFP [W/l/s]	0.44 0.40	0.34 0.32	0.37 0.37
Noise level [dBA]	33 33	35 35	37 37

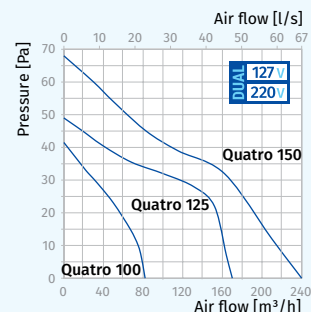

Accessories

Duct system



BlauPlast

Flexible air ducts



BlauFlex

Grilles and hoods



Decor, GM

Speed controllers



CDT E1.8

MCD 60/0.3

Clamps



K, KZ

TUBO

IN-LINE FANS

Features



- o Duct mounting
- o Easy maintenance
- o Low-noise impeller
- o Continuous operation
- o Ball bearing motor
- o 5 year warranty



Air flow:
up to 295 m³/h
82 l/s



Power:
from 16 W
SFP:
from 0.35 W/l/s



Noise level:
from 38 dBA



Options



Model	Tubo 100/125/150
Option	T
Timer	•

- o Turn-off delay adjustable from 2 to 30 min.

Technical data

Model	Tubo 100	Tubo 125	Tubo 150
Voltage [V/Hz]	220-240/50	220-240/50	220-240/50
Power [W]	16	22	29
Current [A]	0.085	0.1	0.13
RPM [min ⁻¹]	2300	2400	2400
Air flow [m ³ /h (l/s)]	102 (28)	195 (54)	295 (82)
SFP [W/l/s]	0.56	0.41	0.35
Noise level [dBA]	38	39	40

Overall dimensions and mounting

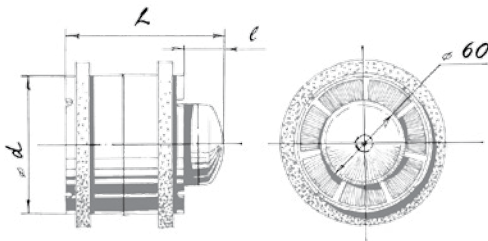

Dimensions [mm]	d	L	l
Tubo 100	98	115	30
Tubo 125	123	115	30
Tubo 150	148	135	30

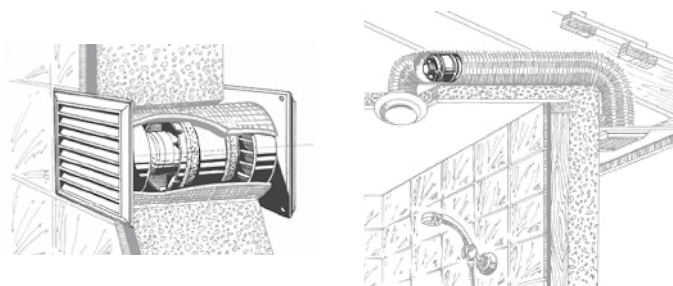
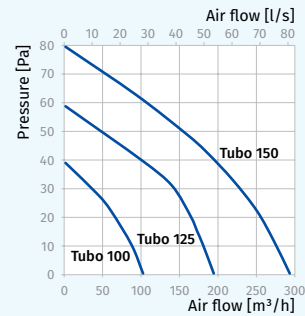

Fixing bracket

Fan with a mounting bracket for mounting to a horizontal or vertical surface.



Tubo-U

Designation key

Tubo	-U	125	T
Model	Fixing bracket	Spigot diameter	Option

Accessories

Air disc valves	Duct system	Flexible air ducts	Grilles and hoods	Speed controllers	Clamps K, KZ
VPR, VSR, VMR	BlauPlast	BlauFlex	Decor, GM	CDT E1.8 MCD 60/0.3	K, KZ

DUCTO

IN-LINE FANS

Brand new low-noise axial inline fans for exhaust or supply ventilation with superior capacity up to 375 m³/h



Air flow:
up to 375 m³/h
104 l/s



Power:
from 4.5 W
SFP:
from 0.22 W/l/s



Noise level:
from 22 dBA



Features



- The casing and the impeller are made of high-quality durable plastic.
- Specially designed mixed-flow impeller profile ensures high air flow and low noise level.
- Protection rating IPX4.
- Low energy usage from 4.5 W.
- The models of **Blauberg Ducto** Series are equipped with a single-phase motor and are available in single- or two speed modifications.
- The motors have thermal overheating protection for motor overload prevention.
- Designed for PVC ducting systems or flexible ducts.
- From low to medium air flow motion for short distances at low air resistance.
- Compatible with Ø 100, 125 and 150 mm air ducts.

Options



- Ducto Plus** – reliable single-phase two speed motor.
- Ducto Power Plus** – two-speed high-powered motor.
- Ducto T** – modification with a regulated timer with the operating time from 2 to 30 minutes.
- Ducto W1** – modification with a power cord with IEC C14 electric plug.

Control



- Manual speed control with a room light switch. It is not included in the delivery package.
- Smooth speed control with a thyristor speed controller (see Electrical Accessories). Several fans may be connected to the same controller. The models with timer are not compatible with a speed controller.
- Automatic fan control with the electronic control unit MCD 60/0.3 (see Electrical Accessories). The control unit is supplied separately.
- Automatic fan control with the timer T (built-in turn-off delay timer enables the fan operation within 2 to 30 minutes after the fan switching off).

Operation modes of fans with timer



Updated automatic control for T modifications of models Ducto Plus 100, 125, 150 and Ducto Power Plus 150 enables to set one of four available operation modes. Changeover to another operation mode by means of by setting the DIP switch to a respective position.

- **Mode 1** (single-speed mode)
The fan is turned off by default. The fan starts operating with the 1st speed when the switch is closed.
- **Mode 2** (single-speed mode)
The fan is turned off by default. The fan starts operating with the 2nd speed when the switch is closed.
- **Mode 3** (two-speed mode)
The fan operates with the 1st speed by default. The fan switches to the 2nd speed when the switch is closed.
- **Mode 4** (automatic interval mode)
The fan operates at the 1st speed by default. Each set time (adjustable from 1 to 15 hours) the fan switches to the 2nd speed automatically and reverts back to 1st speed after 2 - 30 minutes operation with maximum capacity.

Fixing bracket

Ducto-U – modification with a fixing bracket for flat surface mounting.



Ducto-U

Designation key

Ducto	-U	Plus	125
Model	Fixing bracket	Options	Spigot diameter

Accessories

Air disc valves	Duct system	Flexible air ducts	Grilles and hoods	Speed controllers	Clamps K, KZ
VPR, VSR, VMR	BlauPlast	BlauFlex	Decor, GM	CDT E1.8 MCD 60/0.3	K, KZ

DUCTO

IN-LINE FANS

Overall dimensions and mounting

- The fan is mounted into a matching duct size. Fastening with clamps in case of flexible duct connection.
- The mounting bracket enables installation of the fan on horizontal and vertical flat surfaces (Ducto-U model).
- Two fans can be installed in series for higher operation pressure.

Dimensions [mm]	L	Ø D	K
Ducto 100	137.5	100	-
Ducto-U 100	137.5	100	53.5
Ducto 125	161.5	125	-
Ducto-U 125	161.5	125	53.5
Ducto 150	181.5	150	-
Ducto-U 150	181.5	150	53.5

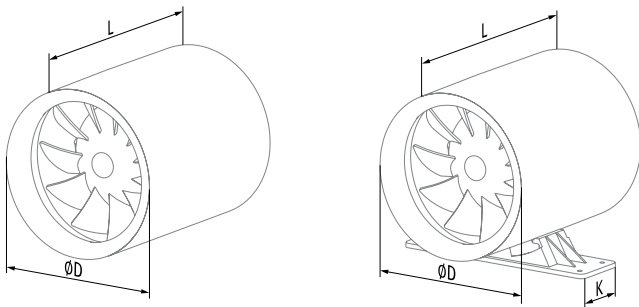

Technical data

Model	Ducto 100		Ducto Plus 100		Ducto 125		Ducto Plus 125		Ducto 150		Ducto Plus 150		Ducto Power Plus 150	
Speed	-	min	max	-	min	max	-	min	max	min	max	min	max	
Voltage [V/Hz]	220-240/50		220-240/50		220-240/50		220-240/50		220-240/50		220-240/50		220-240/50	
Power [W]	7.5	4.5	7.5	13	10	13	22	19	22	22	22	22	25	
Current [A]	0.049	0.029	0.049	0.085	0.065	0.085	0.095	0.087	0.095	0.103	0.109	0.103	0.109	
RPM [min ⁻¹]	2100	1650	2100	2250	1950	2250	2250	1950	2250	2300	2600	2300	2600	
Air flow [m ³ /h (l/s)]	110 (31)	75 (21)	110 (31)	215 (60)	155 (43)	215 (60)	340 (94)	250 (69)	340 (94)	285 (79)	375 (104)	285 (79)	375 (104)	
SFP [W/l/s]	0.25	0.22	0.25	0.22	0.23	0.22	0.23	0.27	0.23	0.28	0.24	0.28	0.24	
Noise level [dBA]	25	22	25	33	29	33	39	36	39	38	41	38	41	
Weight [kg]	0.61	0.61	0.61	0.75	0.75	0.75	1.3	1.3	1.3	1.3	1.3	1.3	1.3	

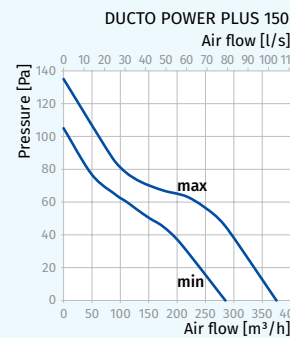
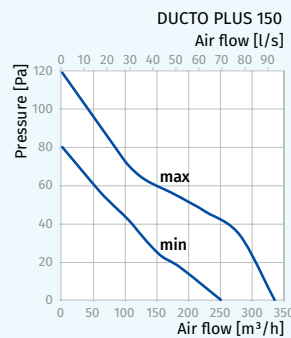
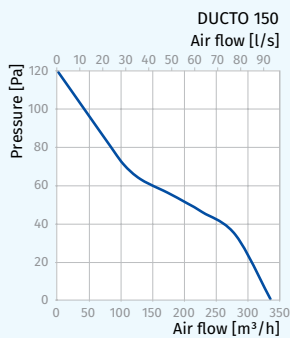
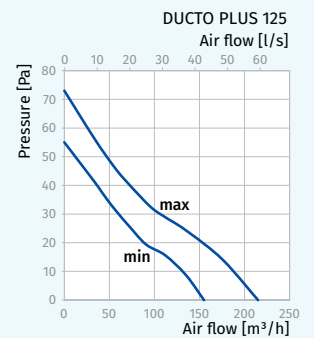
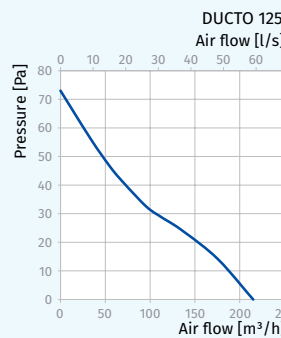
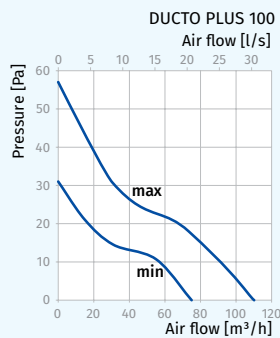
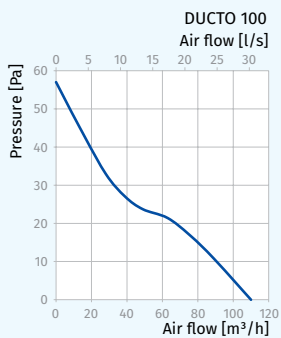

WIND

WINDOW FANS

Features



- Window mounting
- Low-noise impeller
- Easy maintenance
- Ball bearing motor
- Continuous operation
- Automatic shutters
- 5 year warranty



Air flow:
up to 295 m³/h
82 l/s



Power:
from 22 W
SFP:
from 0.32 W/l/s



Noise level:
from 35 dBA



Options



Model	Wind 125/150					
Option	S	T	ST	H	SH	IR
Pull-cord switch	•		•		•	
Timer		•	•	•	•	•
Humidity sensor				•	•	
Motion sensor						•

- Turn-off delay adjustable from 2 to 30 min.
- Humidity setpoint adjustable from 60 % up to 90 %.
- Detection range from 1 up to 4 m.
- Detection angle up to 100°.

Overall dimensions and mounting

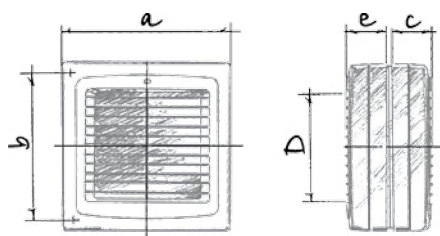

Dimensions [mm]	a	b	e	c	D
Wind 125	186	173	60	53	125
Wind 150	210	195	66	60	150

Technical data

Model	Wind 125	Wind 150
Voltage [V/Hz]	220-240/50	220-240/50
Power [W]	22	26
Current [A]	0.1	0.13
RPM [min ⁻¹]	2400	2400
Air flow [m ³ /h (l/s)]	185 (51)	295 (82)
SFP [W/l/s]	0.43	0.32
Noise level [dBA]	35	41

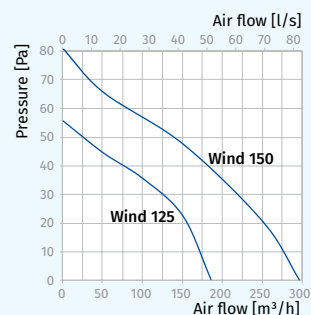

Designation key

Wind	125	ST
Model	Spigot diameter	Option

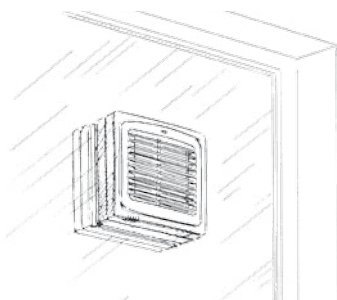

Accessories

Speed controllers



CDT E1.8

MCD 60/0.3

WIND-K

WINDOW FANS

Features



- o Window mounting
- o Low-noise impeller
- o Easy maintenance
- o Ball bearing motor
- o Continuous operation
- o Automatic shutters
- o Integrated ventilation hood with backdraft damper
- o 5 year warranty



Air flow:
185 m³/h
51 l/s



Power:
22 W
SFP:
0.43 W/l/s



Noise level:
35 dBA



Options



Model	Wind-K 125				
	S	T	ST	H	SH
Pull-cord switch	•		•		•
Timer		•	•	•	•
Humidity sensor				•	•

- o Turn-off delay time regulated between 2 and 3 min.
- o Regulated humidity threshold from 60 to 90 %.

Technical data

Model	Wind-K 125
Voltage [V/Hz]	220-240/50
Power [W]	22
Current [A]	0.1
RPM [min ⁻¹]	2400
Air flow [m ³ /h (l/s)]	185 (51)
SFP [W/l/s]	0.43
Noise level [dBA]	35

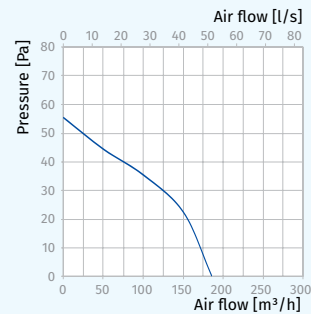

Overall dimensions and mounting

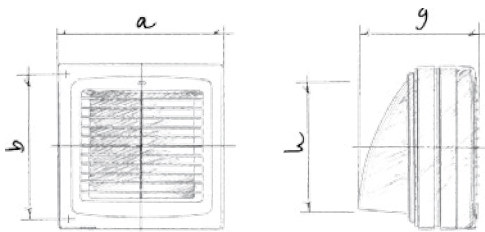

Dimensions [mm]	a	b	g	h
Wind-K 125	186	173	183	160

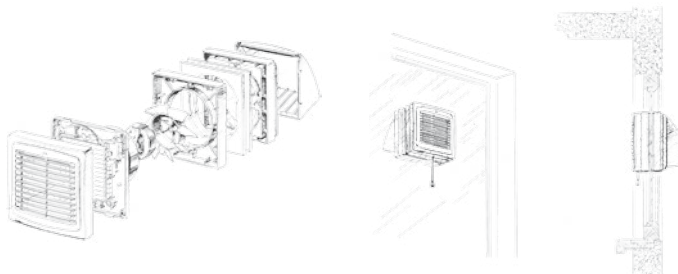

Designation key

Wind	-K	125	SH
Model	With external hood	Spigot diameter	Option



External ventilation hood

Accessories

Speed controllers



CDT E1.8

MCD 60/0.3

CEILEO

CENTRIFUGAL FANS

Centrifugal extract low-noise and low-watt fans for ceiling mounting



Air flow:
up to 320 m³/h
89 l/s



Power:
from 20 W
SFP:
from 0.49 W/l/s



Noise level:
from 24 dBA



Features



- Intermittent or continuous ventilation of bathrooms, showers, kitchens and other domestic spaces.
- For high-resistant ventilation systems.
- Integrated LED-light with low energy demand (**Ceileo Light** models).
- The modular design enables easy retrofitting with the optional humidity and motion sensors (except for the basic model) or the grille with a light.
- Low noise level.
- The centrifugal impeller has forward curved blades for high pressure and low noise.
- The motor impeller is made of high-quality durable ABS plastic.
- The fans also feature a gravity backdraft damper.
- Ingress protection rating IPX4.
- Compatible with Ø 100 or 150 mm air ducts.

Motor

- The Ceileo fans are equipped with reliable asynchronous two-speed motors with overheating protection.
- The maintenance-free permanently lubricated motor bearings are engineered for over 40 000 operating hours of trouble-free operation.

Design

- The casing is made of galvanized steel.
- The clip-on plastic grille ensures easy mounting and cleaning of the fan.
- The modular design enables easy retrofitting with the optional humidity and motion sensors (except for the basic model) or the grille with a light.



- **Ceileo Light** fans are both equipped with an energy-efficient LED light

Power: 10 W
Colour temperature:
3 000 K
Luminous flux:
650 lumens



Power: 60 W

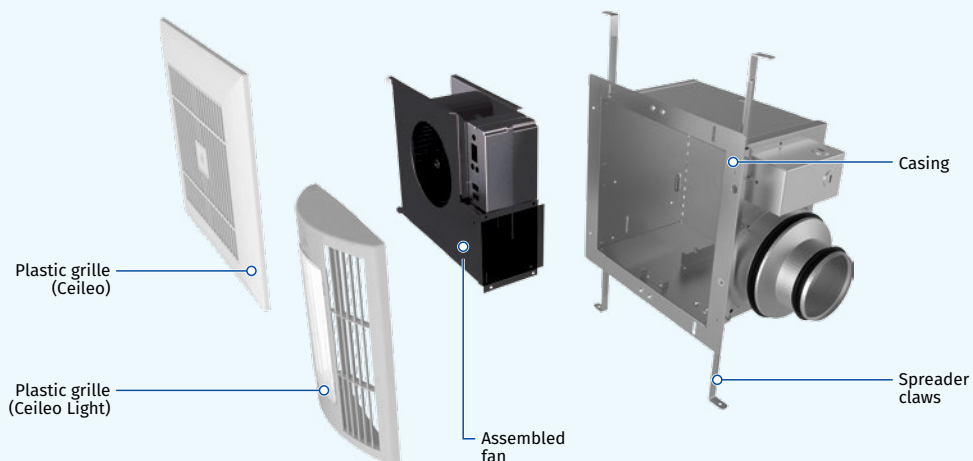

CEILEO

CENTRIFUGAL FANS

Options

Ceileo: Double-speed basic fan model.

Ceileo T: Models with an adjustable turn-off delay timer.

This model can also be retrofitted with an optional humidity or motion sensor (available on a special order).

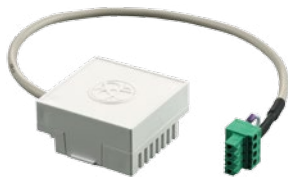

Humidity sensor

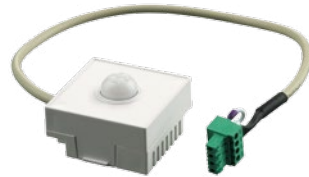

Motion sensor

Control

The built-in control panel of the **Ceileo T** fans enables the following settings:

- turn-off delay
- humidity level
- air flow for the modes 1 and 2

Name	Adjustment range for operation modes 1 and 2
Ceileo 200 T	Off / low speed / high speed
Ceileo 250 T	Off / low speed / high speed
Ceileo 300 T	Off / low speed / high speed

Ceileo T control panel



MANUAL CONTROL

The fan is controlled by means of the CDP-2/10 speed switch (available as a specially ordered accessory).



AUTOMATIC CONTROL



Timer "T": The fan is constantly set to Mode 1. The mode 2 is triggered by the light switch closing. Upon the light switch opening the built-in turn-off delay timer keeps the fan running in the mode 2 from 1 to 90 minutes. On elapsing of this period the fan reverts to the mode 1.



Timer "T" and humidity sensor (available as a specially ordered accessory): the fan runs constantly in the mode 1.

If the indoor humidity level exceeds the sensor threshold value set in the 60-90 % range, the fan switches to the mode 2. When the humidity level reverts to the pre-set value, the built-in turn-off delay timer keeps the fan running in the mode 2 from 1 to 90 minutes. On elapsing of this period the fan reverts to the mode 1.



Timer "T" and motion sensor (available as a specially ordered accessory): the fan runs constantly in the mode 1.

If the motion sensor detects movement within its range, the fan goes to the mode 2. When the movement is no longer registered, the built-in turn-off delay timer keeps the fan running in the mode 2 from 1 to 90 minutes. On elapsing of this period the fan reverts to the mode 1.

Overall dimensions

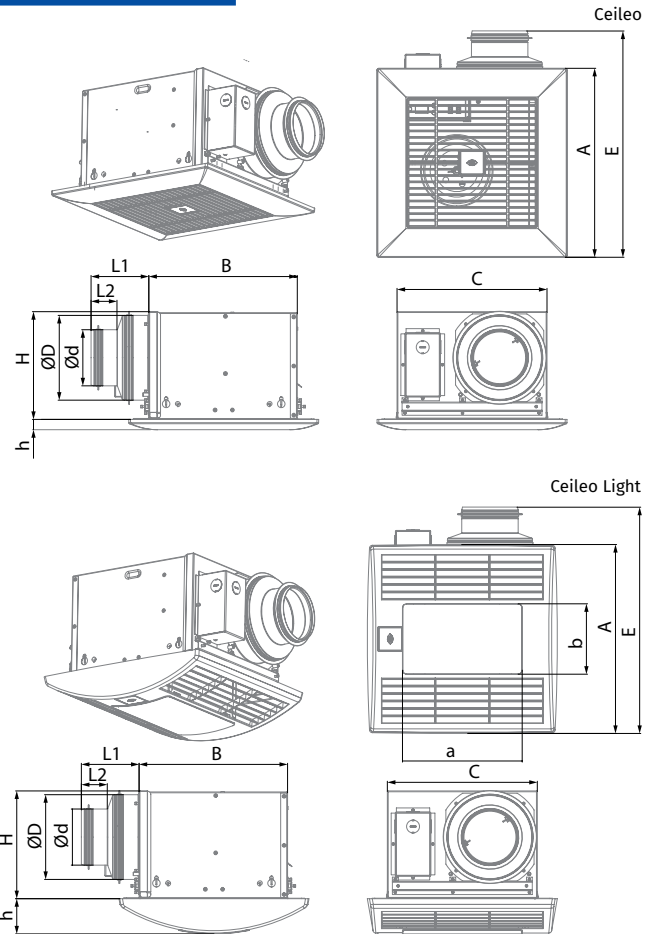

Dimensions [mm]	Ø D	Ø d	L1	L2	A	B	C	E	H	h	a	b
Ceileo 200 / 250	148	98	100	45	330	258	260	395	188	18	-	-
Ceileo 200 / 250 Light	148	98	100	45	330	258	260	395	188	62	208	123
Ceileo 300	149	-	50	-	330	258	260	395	188	18	-	-
Ceileo 300 Light	149	-	50	-	330	258	260	395	188	62	208	123

Mounting

- The fan is integrated into ceiling spaces.
- The fan is attached to the ceiling joists with spreader claws and self-tapping screws.
- The flexible air duct is attached to the fan exhaust spigot with a fixing clamp.



Designation key

Ceileo	200	Light	T
Series	Rated air flow [CFM]	LED-lamp available	Option

CEILEO

CENTRIFUGAL FANS

Technical data

Model	Ceileo 200 (Light) Ceileo 200 (Light) T				Ceileo 250 (Light) Ceileo 250 (Light) T				Ceileo 300 (Light) Ceileo 300 (Light) T			
	230/50		230/60		230/50		230/60		230/50		230/60	
Speed	min	max	min	max	min	max	min	max	min	max	min	max
Power [W]	20	29	21	34	23	39	25	50	31	49	35	63
LED-light power [W*]	2 × 10				2 × 10				2 × 10			
RPM [min ⁻¹]	714	1026	588	936	756	1122	732	1140	936	1254	888	1320
Current [A]	0.1	0.13	0.11	0.15	0.12	0.18	0.14	0.22	0.15	0.22	0.17	0.28
Air flow [m ³ /h (l/s)]	130 (36)	210 (58)	130 (36)	225 (63)	170 (47)	260 (72)	160 (44)	270 (75)	220 (61)	300 (83)	200 (56)	320 (89)
SFP [W/l/s]	0.55	0.50	0.58	0.54	0.49	0.54	0.56	0.67	0.51	0.59	0.63	0.71
Noise level [dB(A)]	24	27	24	28	25	29	25	30	28	31	27	32
Weight [kg]	5.3 (6.4*)				5.3 (6.4*)				5.1 (6.2*)			
Ingress protection	IPX4				IPX4				IPX4			
SEC class	D				C				C			



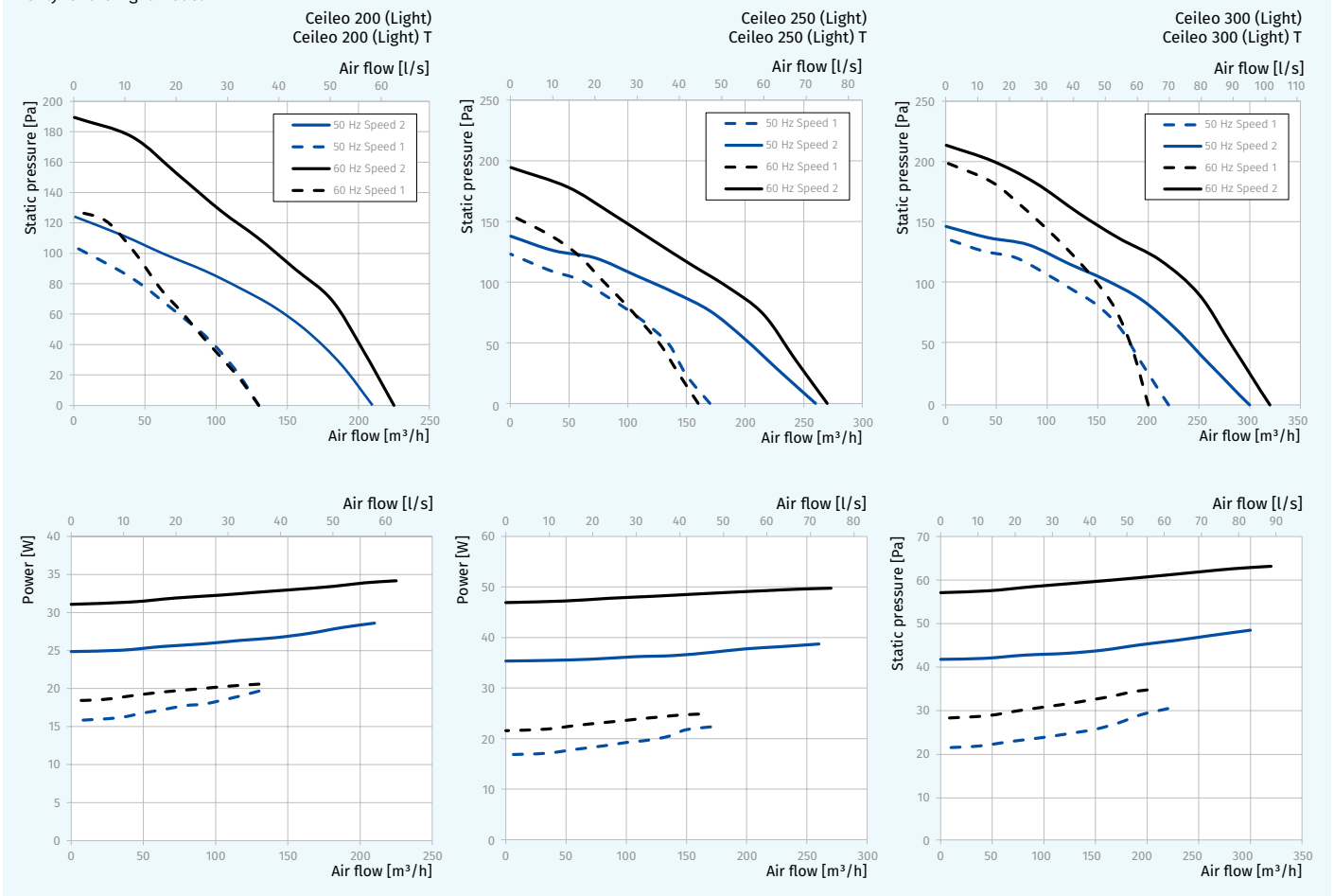









* Only for the Light model



CEILEO

CENTRIFUGAL FANS

Accessories

Accessory name	Description	Ceileo 200 (Light) Ceileo 250 (Light)	Ceileo 300 (Light)	Ceileo 200 (Light) T Ceileo 250 (Light) T	Ceileo 300 (Light) T
CDP-2/10	 Speed switch	•	•	•	•
HS Ceileo	 Humidity sensor			•	•
IRS Ceileo	 Motion sensor			•	•
Decor S 102 HK	 Stainless steel ventilation hood Ø 100 mm	•		•	
Decor S 152 HK	 Stainless steel ventilation hood Ø 150 mm	•	•	•	•
Decor 155x155/100H	 Ventilation hood Ø 100 mm	•		•	
Decor 185x185/150H	 Ventilation hood Ø 150 mm	•	•	•	•
BlauFlex PVC/102/3	 Flexible air duct Ø 100 mm, 3 m long	•		•	
BlauFlex PVC/152/3	 Flexible air duct Ø 150 mm, 3 m long	•	•	•	•
K 100	 Quick-detachable stainless steel clamp Ø 90-110 mm	•		•	
K 150	 Quick-detachable stainless steel clamp Ø 140-160 mm	•	•	•	•
CH-PLC-10WG23	 10 W LED-light with colour temperature 3000 K (only for the Light models)	•	•	•	•

CEILEO DC

CENTRIFUGAL FANS

Centrifugal extract low-noise and low-watt fans for ceiling mounting



Air flow:
up to 254 m³/h
71 l/s



Power:
from 19 W
SFP:
from 0.37 W/l/s



Noise level:
from 23 dBA



Features



- Intermittent or continuous ventilation of bathrooms, showers, kitchens and other domestic spaces.
- For high-resistant ventilation systems.
- DC motor with low energy demand.
- Wide speed control range.
- Integrated LED-light with low energy demand (**Ceileo DC Light** models).
- The modular design enables easy retrofitting with the optional humidity and motion sensors (except for the basic model) or the grille with a light.
- Low noise level.
- Constant air flow.
- The centrifugal impeller has forward curved blades for high pressure and low noise.
- The motor impeller is made of high-quality durable ABS plastic.
- The fans also features a gravity backdraft damper.
- Ingress protection rating IPX4.
- Compatible with Ø 100 or 150 mm air ducts.

Motor

- The **Ceileo DC** fans feature high-efficient low-watt direct current motors with overheating protection.
- The constant air flow technology provides required air flow in a wide range of static pressure.

Design

- The casing is made of galvanized steel.
- The clip-on plastic grille ensures easy mounting and cleaning of the fan.
- The modular design enables easy retrofitting with the optional humidity and motion sensors (except for the basic model) or the grille with a light.



- Ceileo DC Light fans are both equipped with an energy-efficient LED light

Power: 10 W
Colour temperature:
3 000 K
Luminous flux:
650 lumens



Power: 60 W

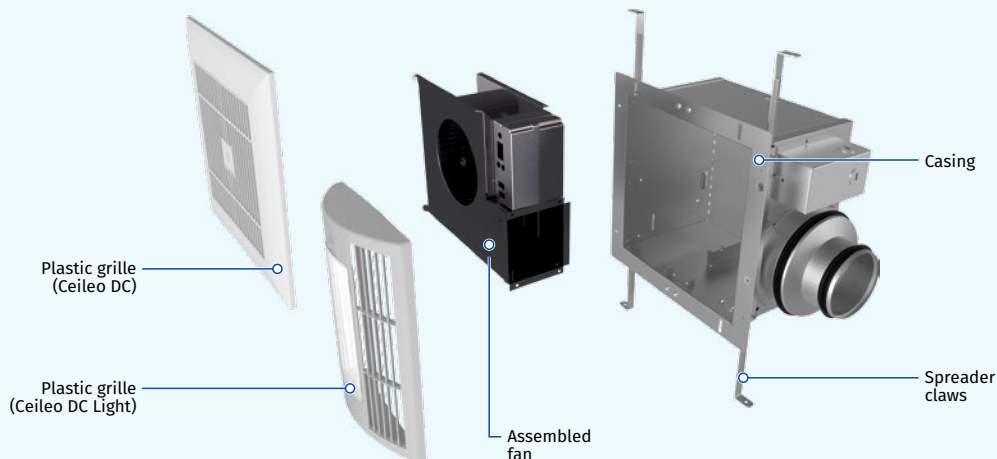

CEILEO DC

CENTRIFUGAL FANS

Options

Ceileo DC fans include an integrated turn-off delay timer. The fan can also be retrofitted with an optional humidity or motion sensor (available on a special order).

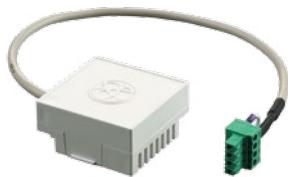

Humidity sensor

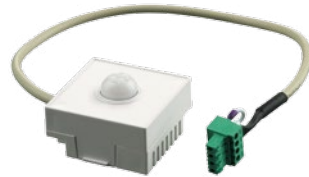

Motion sensor

Control

The built-in control panel of the Ceileo DC fans enables the following settings:

- turn-off delay
- humidity level
- air flow for the modes 1 and 2

Name	Adjustment range for operation modes 1 and 2
Ceileo DC 110	Off / 100 / 120 / 135 / 155 / 170 / 190 m ³ /h
Ceileo DC 150	Off / 100 / 120 / 135 / 155 / 170 / 190 / 205 / 220 / 240 / 250 m ³ /h

Ceileo DC control panel

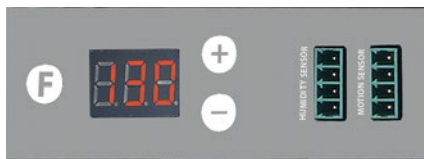

MANUAL CONTROL

The fan is controlled by means of the CDP-2/10 speed switch (available as a specially ordered accessory).



AUTOMATIC CONTROL



Timer: The fan is constantly set to Mode 1. The mode 2 is triggered by the light switch closing. Upon the light switch opening the built-in turn-off delay timer keeps the fan running in the mode 2 from 1 to 90 minutes. On elapsing of this period the fan reverts to the mode 1.



Timer and humidity sensor (available as a specially ordered accessory): the fan runs permanently in the mode 1. If the humidity level on the premises exceeds the sensor threshold value set in the 60-90 % range, the fan switches to the mode 2. When the humidity level reverts to the pre-set value, the built-in turn-off delay timer keeps the fan running in the mode 2 from 1 to 90 minutes. On elapsing of this period the fan reverts to the mode 1.



Timer and motion sensor (available as a specially ordered accessory): the fan runs permanently in the mode 1. If the motion sensor detects movement within its range, the fan goes to the mode 2. When the movement is no longer registered, the built-in turn-off delay timer keeps the fan running in the mode 2 from 1 to 90 minutes. On elapsing of this period the fan reverts to the mode 1.

Overall dimensions

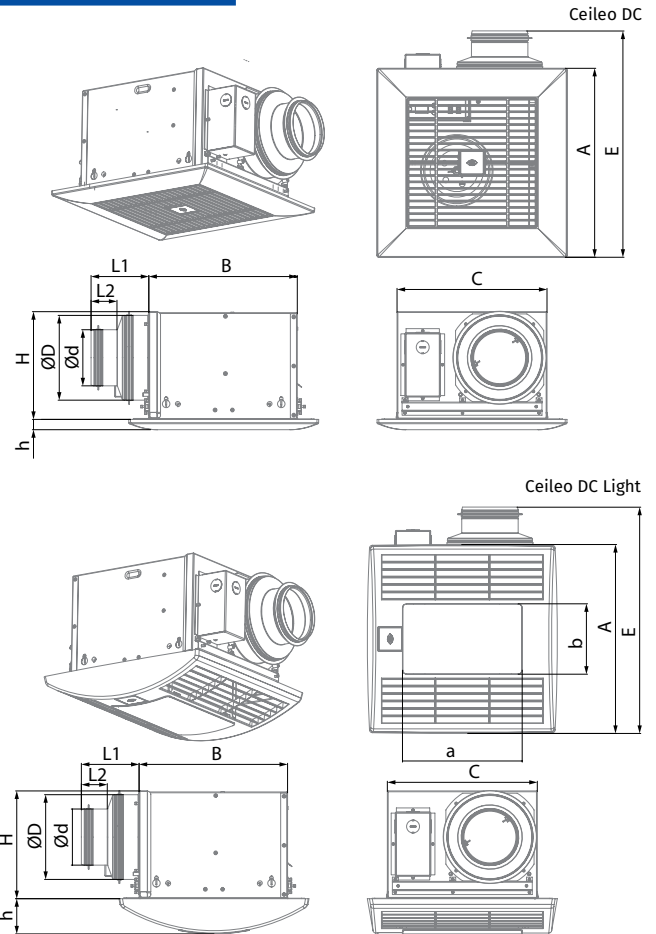

Dimensions [mm]	Ø D	Ø d	L1	L2	A	B	C	E	H	h	a	b
Ceileo DC 110	148	98	100	45	330	258	260	395	188	18	-	-
Ceileo DC 110 Light	148	98	100	45	330	258	260	395	188	62	208	123
Ceileo DC 150	149	-	50	-	330	258	260	395	188	18	-	-
Ceileo DC 150 Light	149	-	50	-	330	258	260	395	188	62	208	123

Mounting

- The fan is integrated into ceiling spaces.
- The fan is attached to the ceiling joists with spreader claws and self-tapping screws.
- The flexible air duct is attached to the fan exhaust spigot with a fixing clamp.



Designation key

Ceileo	DC	110	Light
Series	DC motor	Rated air flow [CFM]	LED-lamp available

CEILEO DC

CENTRIFUGAL FANS

Technical data

Model	Ceileo DC 110 Ceileo DC 110 Light	Ceileo DC 150 Ceileo DC 150 Light
Voltage [V/Hz]	120-240/50(60)	120-240/50(60)
Power [W]	19	26
LED-light power [W*]	2 x 10	2 x 10
RPM [min ⁻¹]	1100	1100
Current @ 230 V (120 V) [A]	0.18 (0.3)	0.24 (0.39)
Air flow [m ³ /h (l/s)]	187 (52)	254 (71)
SFP [W/l/s]	0.37	0.37
Noise level [dB(A)]	23-25	23-29
Weight [kg]	5.3 (6.4*)	5.1 (6.2*)
Ingress protection	IPX4	IPX4
SEC class	C	C

* Only for the Light model



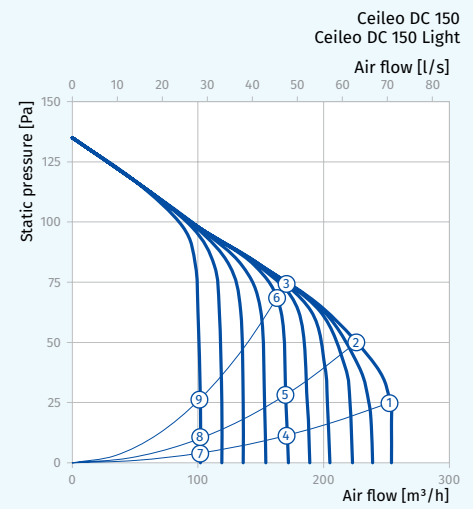
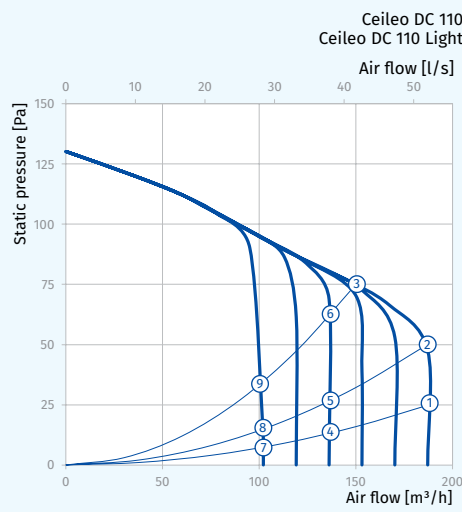









Point	Power [W]	
	Ceileo DC 110 Ceileo DC 110 Light	Ceileo DC 150 Ceileo DC 150 Light
1	17	24
2	19	22
3	16	19
4	9	13
5	12	15
6	15	17
7	4	5
8	4	5
9	6	6



CEILEO DC

CENTRIFUGAL FANS

Accessories

Accessory name	Description	Ceileo DC 110 Ceileo DC 110 Light	Ceileo DC 150 Ceileo DC 150 Light
CDP-2/10	 Speed switch	•	•
HS Ceileo	 Humidity sensor	•	•
IRS Ceileo	 Motion sensor	•	•
Decor S 102 HK	 Stainless steel ventilation hood Ø 100 mm	•	
Decor S 152 HK	 Stainless steel ventilation hood Ø 150 mm	•	•
Decor 155x155/100H	 Ventilation hood Ø 100 mm	•	
Decor 185x185/150H	 Ventilation hood Ø 150 mm	•	•
BlauFlex PVC/102/3	 Flexible air duct Ø 100 mm, 3 m long	•	
BlauFlex PVC/152/3	 Flexible air duct Ø 150 mm, 3 m long	•	•
K 100	 Quick-detachable stainless steel clamp Ø 90-110 mm	•	
K 150	 Quick-detachable stainless steel clamp Ø 140-160 mm	•	•
CH-PLC-10WG23	 10 W LED-light with colour temperature 3000 K (only for the Light models)	•	•

FORCE / FORCE MAX

CENTRIFUGAL FANS

Features



- Centrifugal fans.
- Wall surface or flush mounting.
- Centrifugal impeller with forwards curved blades ensures high pressure.
- Gravity backdraft damper for back flow prevention.
- Removable grille with dust filter.
- Modification with a grease filter (model Force...A) for use as a kitchen exhaust hood.
- Continuous operation.
- 5 years warranty.



Air flow
up to 122 m³/h
34 l/s



Power
from 16 W
SFP:
from 0.59 W/l/s



Sound pressure level
from 36 dBA



Options



Model	Force (Max) 100					
	S	T	ST	H	SH	IR
Pull-cord switch	•		•		•	
Timer		•	•	•	•	•
Humidity sensor				•	•	
Motion sensor						•

- Timer**
 - Turn-off delay timer adjustable from 2 to 30 min.
- Humidity sensor**
 - Humidity setpoint adjustable from 60 % up to 90 %.
 - Turn-off delay adjustable from 2 up to 30 min.
- Motion sensor**
 - Detection range from 1 up to 4 m.
 - Detection angle up to 100°.
 - Turn-off delay adjustable from 2 up to 30 min.

Overall dimensions

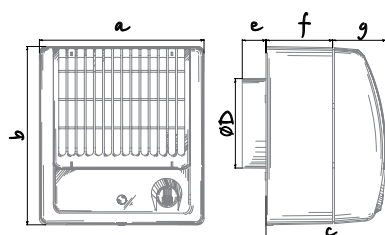

Dimensions [mm]	a	b	c	ØD	e	f	g
Force (Max) 100	180	195	132	98	26	73	59

Technical data

Model	Force 100	Force Max 100
Voltage [V/Hz]	220-240/50	220-240/50
Power [W]	16	29
Air flow [m ³ /h (l/s)]	98 (27)	122 (34)
SFP [W/l/s]	0.59	0.86
Noise level [dBA]	36	38
RPM [min ⁻¹]	2250	2500

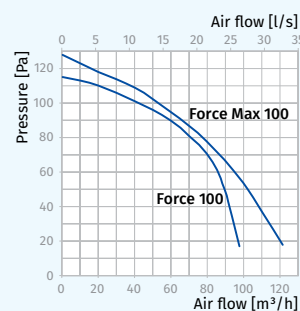

Designation key

Force	Max	100	T	A
Model	High-powered motor	Spigot diametr	Option	Grease filter

Accessories

Duct system



BlauPlast

Flexible air ducts



BlauFlex

Grilles and hoods



Decor, GM

Speed controllers



CDT E1.8

MCD 60/0.3

Clamps



K, KZ

Replaceable filters



FP(A)-Force

FP-Force

FRESHER

WALL VENTS

Features

- Efficient energy saving supply ventilation in flats, houses, cottages, social and commercial spaces.
- Coarse and fine filters ensure fresh filtered air supply to premises.
- Various operation modes and regulated air exchange create individually controlled microclimate.
- Organization of the air supply system with centralized control based on several ventilation units.



Air flow:
up to 50 m³/h
14 l/s



Power:
from 3.8 W
SFP:
from 0.48 W/l/s



Noise level:
from 13 dBA



NEW



Design

The ventilator consists of a cartridge with filters, an air duct with sound absorbing material, an indoor unit with a decorative front panel and an outer ventilation hood. The cartridge consists of an energy efficient EC fan and filters that ensure coarse and fine filtration of supply air. The indoor unit is in the basic version equipped with automatic shutters that close during the

ventilator standstill and prevent air backdraft. The outer ventilation hood is used to prevent direct ingress of water and other objects to the ventilator. A remote control, an extended air duct (700 mm) and different external grilles are optionally available for the Fresher 50 units.

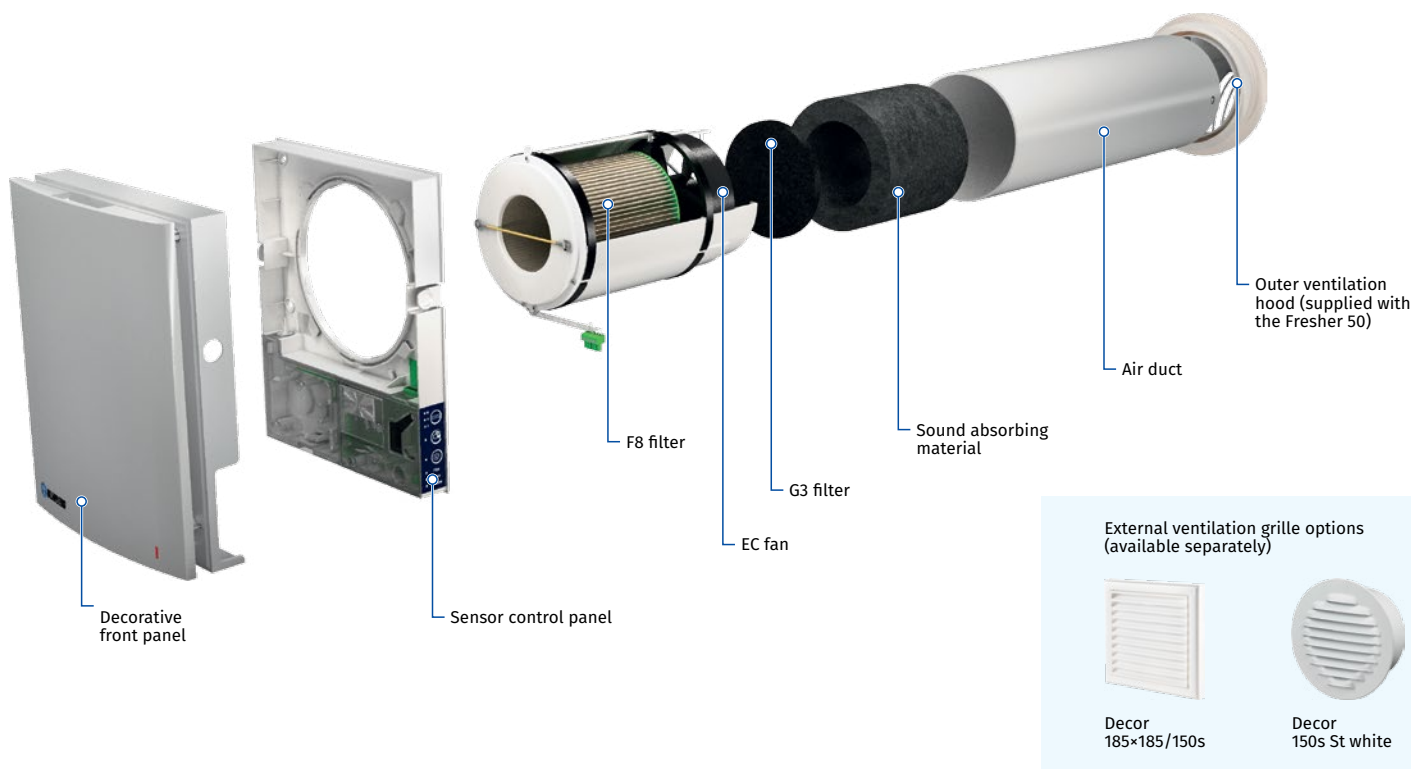

Easy maintenance. The indoor unit can be opened applying a light pressure from both sides



The built-in automatic air shutters prevent back air draft

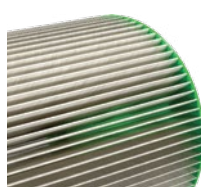

One of the highest air cleaning efficiency ratings on the market through the use of a modern filter system



The specially designed front panel provides 100 % tightness and wind protection

FRESHER

WALL VENTS

Control

The ventilator can be operated with the sensor control panel on the unit casing or with the remote control (FB Fresher 50).

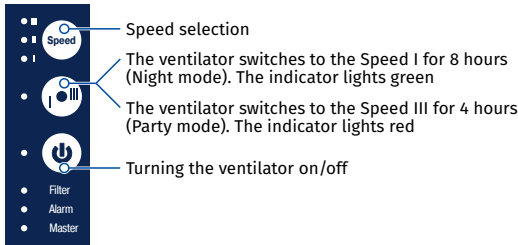

Remote control

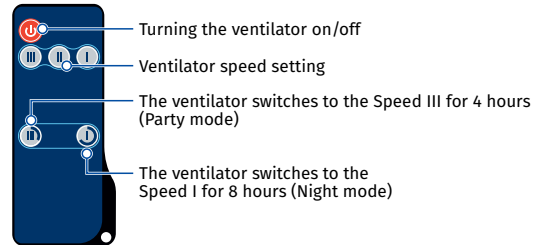

The ventilator design enables connecting any external controls, such as a humidity sensor, an external CO₂ sensor or a switch. Connection of several ventilators in series provides effective, optimal ventilation. The first unit

in series becomes the master unit. Ventilation mode is controlled via the control panel on the master unit. The signal from the remote control is received by the first ventilator (master) only.

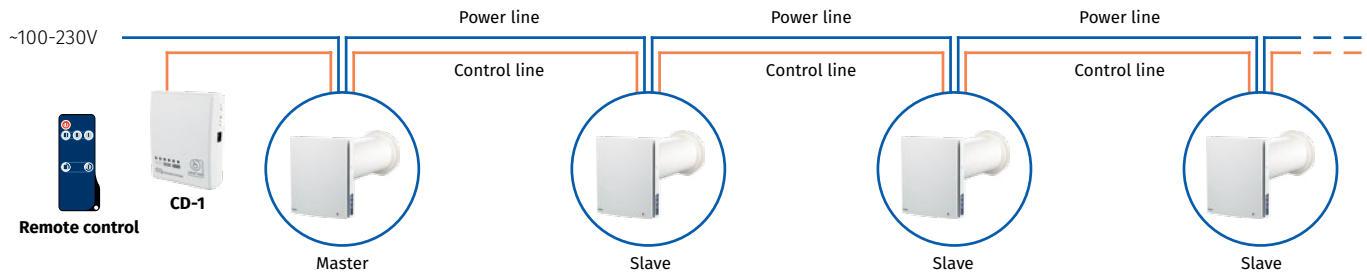

Mounting

The unit is designed for through-the-wall mounting into a round hole provided in the outer wall. The unit installation in new-construction buildings is carried out in two phases:

1. Preassembly at the stage of interior and exterior finishing of walls (installing the air duct and the outer ventilation hood, electrical cable laying)

2. Final assembly - before commissioning the house. It includes installation of the cartridge with the fan and filters as well as installation and connection of the indoor unit with the controller and air shutters.

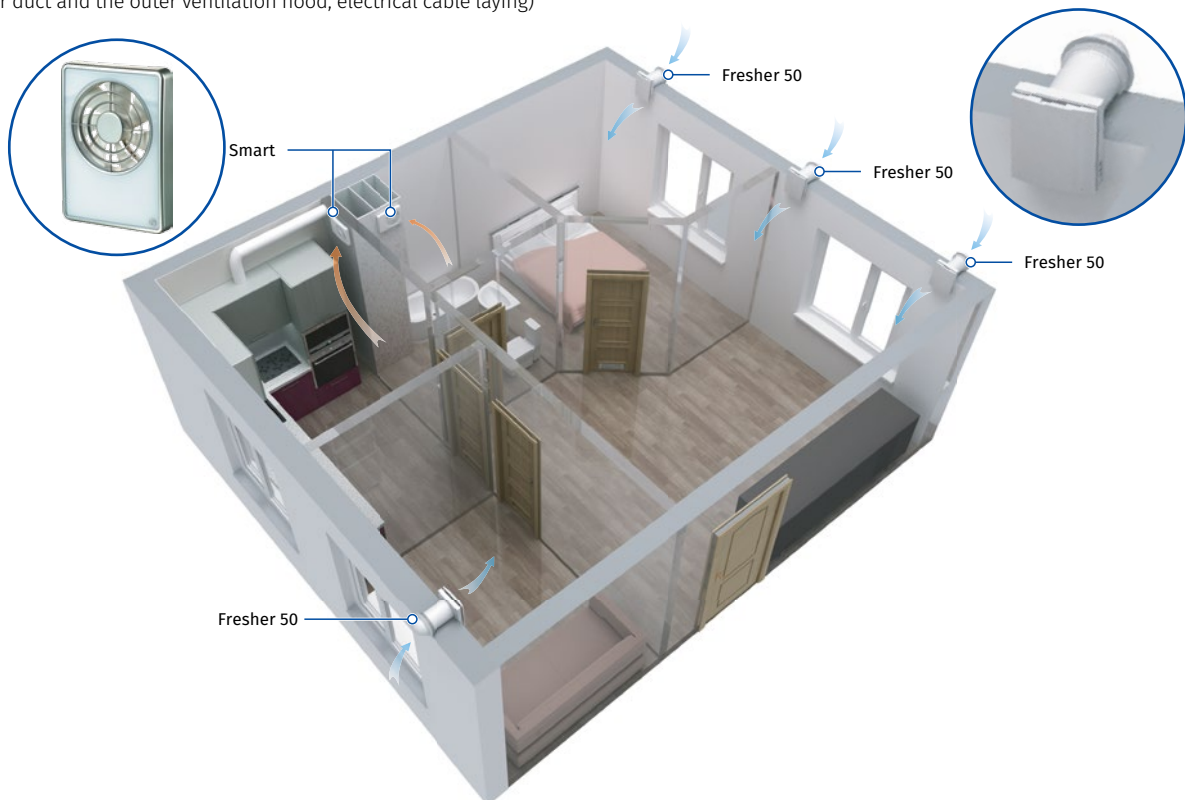

FRESHER

WALL VENTS

Overall dimensions [mm]

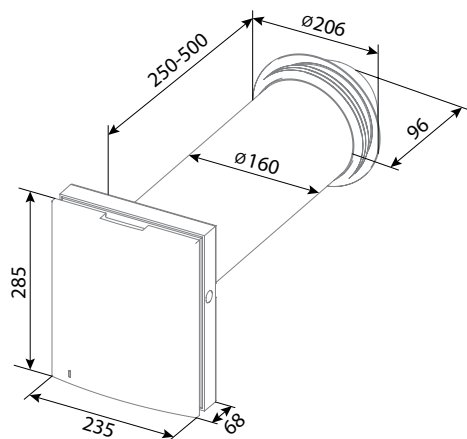

Fresher 50

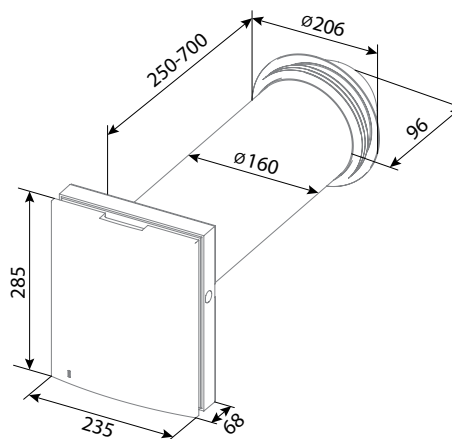

Fresher 50 L

Technical data

Model	Fresher 50 / Fresher 50 L		
	I	II	III
Speed			
Voltage [V/50 (60) Hz]	1~100-240		
Power [W]	3.8	4.7	7.4
Current [A]	0.031	0.039	0.061
Air flow [m ³ /h (l/s)]	20 (6)	35 (10)	50 (14)
SFP [W/l/s]	0.68	0.48	0.53
Transported air temperature [°C]	from -30 to +50		
Noise level, 1 m [dBA]	22	29	32
Noise level, 3 m [dBA]	13	20	23
Outdoor noise attenuation [dBA]	41		
PM 2.5 removal efficiency [%]	98		
Ingress protection	IP24		

Ecodesign parameters

Trade mark	BLAUBERG					
Model	Fresher 50					
Specific energy consumption (SEC) [kWh(m ² a)]	Cold		Average		Warm	
	-53.2	A+	-26.1	B	-10.6	E
Type of ventilation unit	One-directional					
Type of drive installed	Multiple-reduction drive					
Type of heat recovery system	No					
Thermal efficiency of heat recovery [%]	n/a					
Maximum air flow [m ³ /h]	50					
Power [W]	7					
Sound power level [dBA]	40					
Reference flow rate [m ³ /s]	0.01					
Reference pressure difference [Pa]	n/a					
Specific power input (SPI) [W/m ³ /h]	0.134					
Control typology	Local demand control					
Maximum internal leakage rates [%]	n/a					
Maximum external leakage rates [%]	2.7					
Internet address	http://www.blaubergventilatoren.de/					
The annual electricity consumption (AEC) [kWh electricity/a]	Cold		Average		Warm	
	0.9		0.9		0.9	
The annual heating saved (AHS) [kWh primary energy/a]	Cold		Average		Warm	
	55.4		283		12.8	

FRESHER

WALL VENTS

Designation key				
Fresher	50	_: 500 L: 700	_: hood by default 1: grille Decor 150s St white 2: grille Decor 185*185/150s	_: no remote control FB: remote control is included
Model	Air flow [m³/h]	Air duct length [mm]	External grille type	Option

Accessories

Accessory name		Description
FP Fresher 50 F8		Filter kit: G3 filter (1 pc) + F8 filter (1 pc)
FB Fresher 50		Remote control
CD-1		CO ₂ sensor with LED indication and on/off button
CD-2		CO ₂ sensor
HR-S		Room humidistat

SQ

WALL VENT

Features

- Wall mounting
- Easy maintenance
- Temperature- and UV-resistant antistatic plastic
- Manual adjustment of effective cross section
- Completed with adjustable grille, rectangular PVC slim duct, and fixed grille grille



Overall dimensions and mounting

Adjustable grille

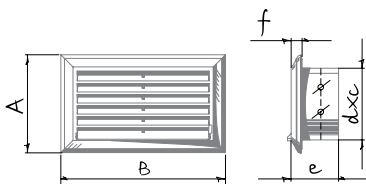

Rectangular PVC slim duct

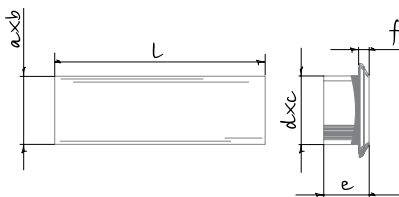

Fixed grille

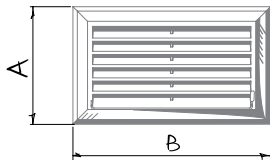

Dimensions [mm]	A	B	a	b	c	d	e	f	L
SQ 110/35	81	136	55	110	114	59	42	12	350
SQ 204/35	86	230	60	204	208	64	42	12	350

Technical data

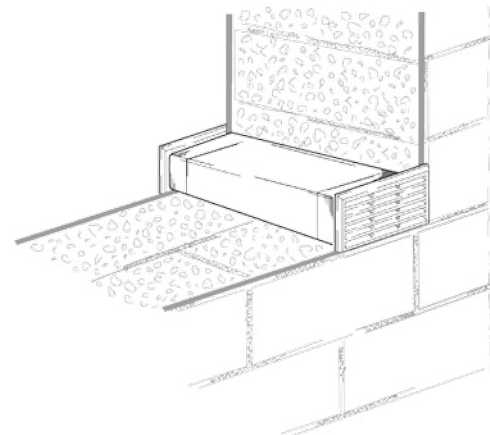
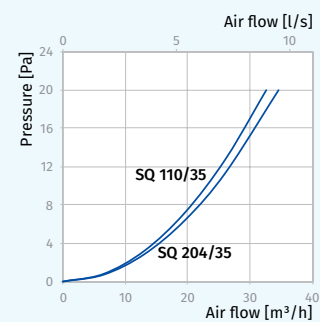

WHM

WALL VENT

Features

- o For the mounting in external wall in the room
- o Provides steady fresh air intake
- o Supplied with a dust filter
- o Manual adjustment of effective cross section
- o Easy maintenance
- o Telescopic duct



Modifications

WHM 100 DR – with a round external grille.
WHM 100 DR (color) – with external colour grille.



WHM 100 D – with external white square grille.
WHM 100 D (color) – with external colour square grille.



WHM 100 DK – with a ventilation hood.
WHM 100 DK (color) – with a color ventilation hood.



WHM 100 DS – with a stainless steel ventilation hood.



Overall dimensions [mm] and mounting

Internal grille

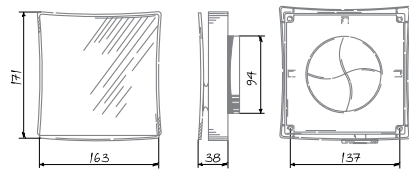

External grille (plastic)

Square external grille

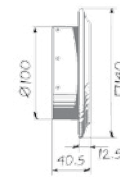

Round external grille

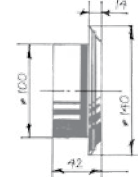

Ventilation hood

Plastic ventilation hood

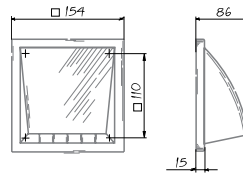

Stainless steel ventilation hood

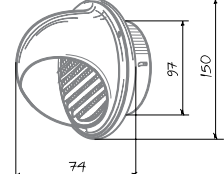

Telescopic duct

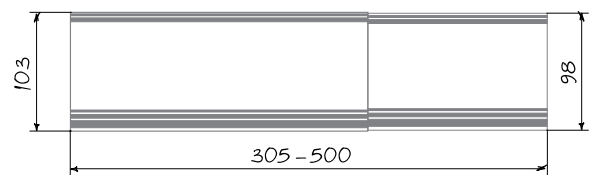

Technical data

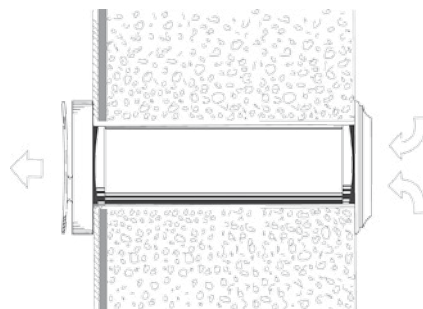
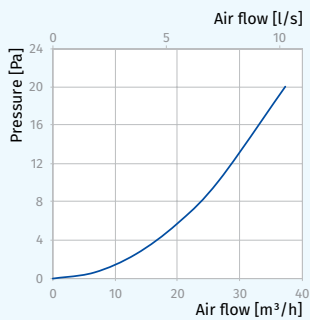

Designation key			
WHM	100	DK	Gray
Model	Spigot diameter	Type of external grille	Color

SHM

WALL VENTS WITH SOLAR PANEL

Features



- Power-independent operation due to the solar panel activated motor.
- Efficient and environment friendly operation based on natural resources.
- Operation as ordinary passive vents in case of no solar energy supply.
- Higher exchange rate as compared to other standard passive ventilation components.
- Uniform air supply and distribution free of dust and noise.
- Mounting on the outer walls on a sunny side.
- The internal grille is made of high-quality ABS plastic and is equipped with a dust G3 dust filter.
- Equipped with axial fan driven by DC motor that is powered by solar panel.



- The fan operates either in supply or exhaust mode depending on modification type.
- The round air flow regulator provides smooth regulation of air flow or shutoff of the ventilation duct.



- Telescopic duct with adjustable length from 250 to 420 mm is made of durable PVC plastic.
- 100 mm air duct diameter.
- The outer ventilation hood is made of high-quality ABS plastic.
- Solar panel is fixed directly on the hood surface.

Technical data

Model	SHM 100 DK
Battery power [W]	2.5
Air flow [m³/h]	20
Spigot diameter [mm]	100

Air flow rate in various directions

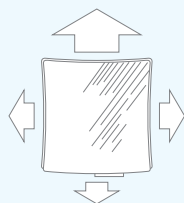

Overall dimensions [mm]

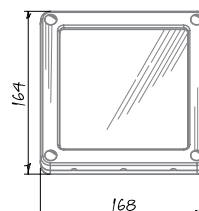
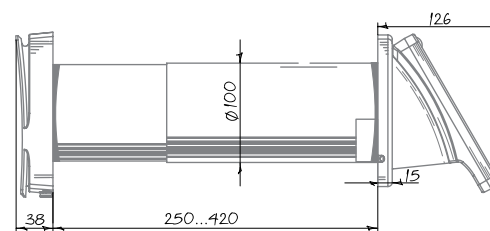
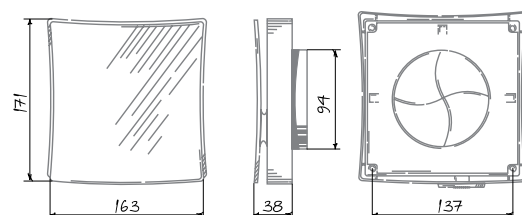

Designation key

SHM	100	DK
Model	Spigot diameter	Type of external grille

FHM

WINDOW VENTS

Features

- Installation into window frame.
- Uniform natural air flow, free of drafts and outside noise.
- Integrated dust filter ensures fresh air supply and prevents ingress of dirt and dust into the room.
- Regulation of supply air flow direction due to adjustment of the inner grille.
- Outer hood against water ingress.
- Easy mounting and maintenance.
- Temperature and UV resistant antistatic plastic.
- Available in gray and brown colors; White - by default.

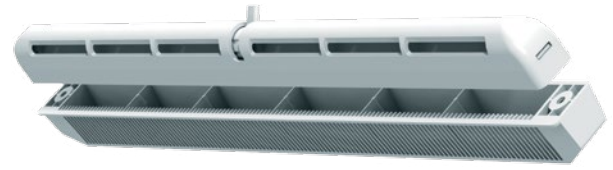

Gray



Brown

Overall dimensions [mm]

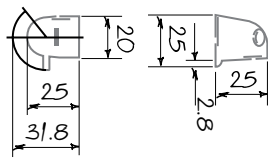
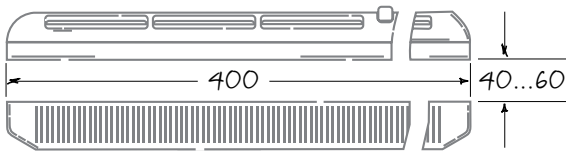

Technical data

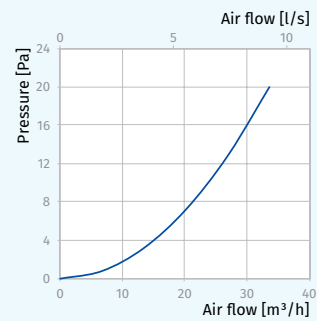

Designation key

FHM	400	Gray
Model	Length	Color

KIT AERO-BW

HEAT MOVERS

Features



- For premises heated with chimneys and other heating systems.
- Provides hot air circulation from heated rooms to other premises.
- Installation into outer and dividing walls.
- Supplied with a thermostat (automatically switches the fan on at set temperature from 10 to 30 °C).
- Telescopic duct for wall installation.
- Continuous operation.
- Ball bearing motor.
- Easy maintenance.
- 5 year warranty.



Air flow:
84 m³/h
23 l/s



Power:
5.5 W
SFP:
0.24 W/l/s



Noise level:
25 dBA



KIT Aero-BW 100/40-1



Fan
Aero Still 100



Round telescopic duct
BlauPlast RTR 100



Round grille
Decor 100s



Thermostat
TS E10

KIT Aero-BW 100/40-2



Fan
Aero Still 100



Round telescopic duct
BlauPlast RTR 100



Square grille
Decor 140x140/100s



Thermostat
TS E10

Overall dimensions [mm] and mounting

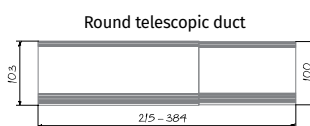
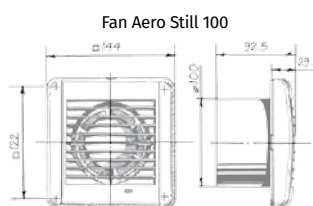

Square grille

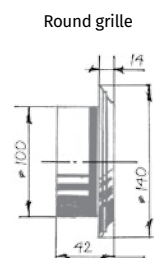

Round grille

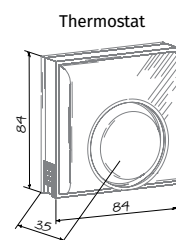

Thermostat

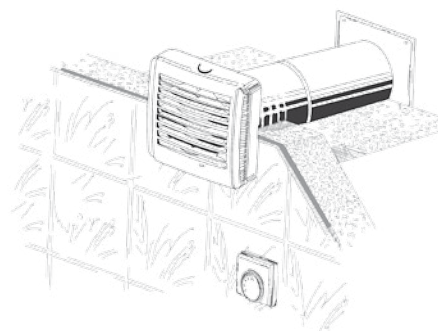

Technical data

Model	KIT Aero-BW 100/40 (Aero Still 100)
Voltage [V/Hz]	220-240/50
Power [W]	5.5
Air flow [m ³ /h (l/s)]	84 (23)
SFP [W/l/s]	0.24
Noise level [dBA]	25

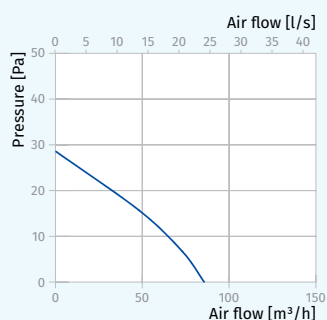

KIT BRAVO-BW

HEAT MOVERS

Features



- For premises heated with chimneys and other heating systems.
- Provides hot air circulation from heated rooms to other premises.
- Installation into outer and dividing walls.
- Supplied with a thermostat (automatically switches the fan on at set temperature from 10 to 30 °C).
- Telescopic duct for wall installation.
- Continuous operation.
- Ball bearing motor.
- Easy maintenance.
- 5 year warranty.



Air flow:
70 m³/h
19 l/s



Power:
5.6 W
SFP:
0.29 W/l/s



Noise level:
26 dBA



KIT Bravo-BW 100/40-1



Fan Bravo Still 100



Round telescopic duct BlauPlast RTR 100



Round grille Decor 100s



Thermostat TS E10

KIT Bravo-BW 100/40-2



Fan Bravo Still 100



Round telescopic duct BlauPlast RTR 100



Square grille Decor 140x140/100s



Thermostat TS E10

Overall dimensions [mm] and mounting

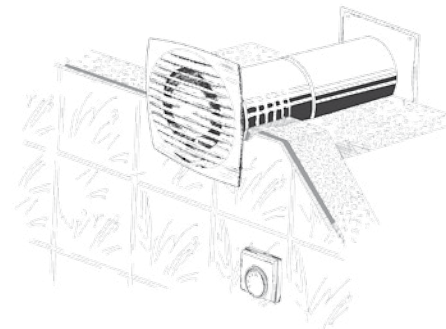
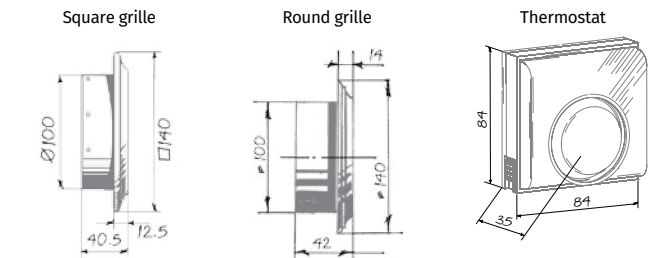
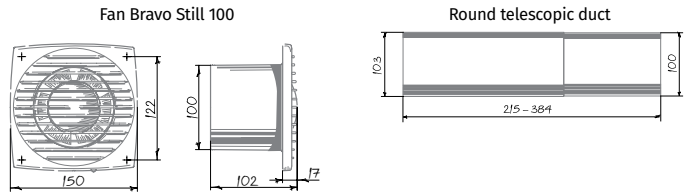

Technical data

Model	KIT Bravo-BW (Bravo Still 100)
Voltage [V/Hz]	220-240/50
Power [W]	5.6
Air flow [m ³ /h (l/s)]	70 (19)
SFP [W/l/s]	0.29
Noise level [dBA]	26

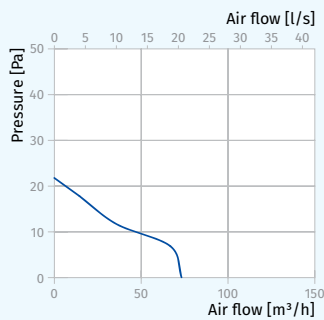

DECOR S HK

METAL HOODS

Features

- Outer wall mounting
- Decoration of ventilation shaft vents and connection to round air ducts
- Equipped with a backdraft damper for back flow prevention
- Made of stainless steel
- Equipped with a rubber sealing ring



Overall dimensions and mounting

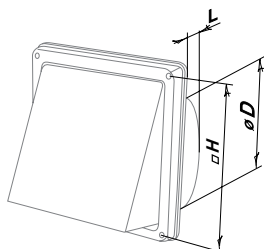

Model	Dimensions [mm]			Air pass [m ²]
	$\varnothing D$	H	L	
Decor S 137*137/102HK	97	137	52	0.0071
Decor S 167*167/122HK	120	167	52	0.0113
Decor S 167*167/152HK	145	167	62	0.0165



DECOR S HK

METAL HOODS

Features

- Outer wall mounting
- Decoration of ventilation shaft vents and connection to round air ducts
- Protection grille against birds and rodents
- Made of stainless steel
- Equipped with a rubber sealing ring



Overall dimensions

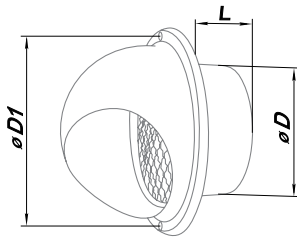

Model	Dimensions [mm]			Air pass [m ²]
	$\varnothing D$	$\varnothing D1$	L	
Decor S 102 HK	97	133	52	0.0048
Decor S 122 HK	120	165	52	0.0082
Decor S 152 HK	145	192	62	0.0126
Decor S 162 HK	155	192	62	0.0135
Decor S 202 HK	195	253	62	0.0178

DECOR H

PLASTIC HOODS

Features

- Outer wall mounting
- Decoration of ventilation shaft vents or for connection to rectangular or round air ducts
- Modification may include a gravity backdraft damper for back flow prevention
- Protection grille against birds and rodents
- Temperature- and UV-resistant antistatic plastic
- Flush mounting is possible
- Flush mounted fasteners
- Easy maintenance



Options

Model	Basic Model	Valve	Flange
Decor 155x155H	•		
Decor 155x155/100H			•
Decor 155x155/100HK		•	•
Decor 155x155HK		•	
Decor 155x155/HU			•
Decor 155x155/HUK		•	•
Decor 185x185H	•		
Decor 185x185HK		•	
Decor 185x185/125H			•
Decor 185x185/125HK		•	•
Decor 185x185/150H	•		•
Decor 185x185/150HK		•	•

Without flange



Backdraft damper



Non-adjustable flange

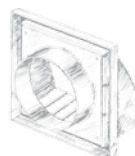

Universal flange

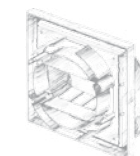

Overall dimensions and mounting

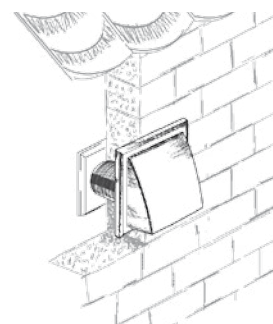
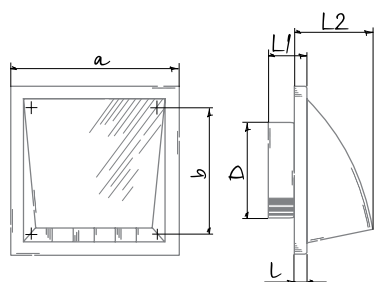

Model	Dimensions [mm]						Ø D	Air pass [m ²]
	a	b	l	L1	L2			
Decor 155x155H	154	110	15	—	87	—	0.008	
Decor 155x155/100H	154	110	15	45	87	100	0.008	
Decor 155x155/100HK	154	110	15	45	87	100	0.008	
Decor 155x155HK	154	110	15	—	87	—	0.008	
Decor 155x155/HU	154	110	15	39	87	100, 125, 55 × 110	0.08	
Decor 155x155/HUK	154	110	15	39	87	100, 125, 55 × 110	0.08	
Decor 185x185H	186	142	15	—	101	—	0.012	
Decor 185x185HK	186	142	15	—	101	—	0.012	
Decor 185x185/125H	186	142	15	45	101	125	0.012	
Decor 185x185/125HK	186	142	15	45	101	125	0.012	
Decor 185x185/150H	186	142	15	50	101	150	0.012	
Decor 185x185/150HK	186	142	15	50	101	150	0.012	

DECOR G

PLASTIC GRAVITY GRILLES

Features

- o Outer wall mounting
- o Decoration of ventilation shaft vents or for connection to round air ducts
- o Equipped with gravity louvre shutters for back flow prevention
- o Temperature- and UV-resistant antistatic plastic
- o Flush mounted fasteners
- o Easy maintenance



Options

Model	Basic Model	Flange
Decor 155x155G	•	
Decor 155x155/UG		•
Decor 185x185G	•	
Decor 185x185/125G		•
Decor 250x250G	•	
Decor 250x250/150G		•

Without flange



Non-adjustable flange
Ø125 mm, Ø150 mm

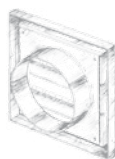

Universal flange
Ø100 mm, Ø125 mm, 55 × 110 mm

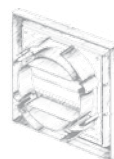

Overall dimensions and mounting

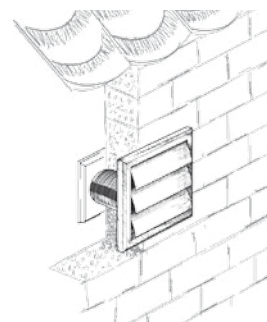
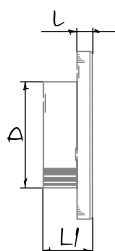
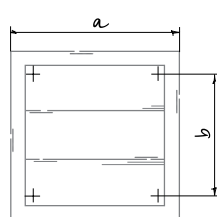

Model	Dimensions [mm]					Ø D	Air pass [m²]
	a	b	l	L1			
Decor 155x155G	154	110	15	—	—	—	0.0096
Decor 155x155/UG	154	110	15	45	100, 125, 55 × 110	—	0.0096
Decor 185x185G	186	142	15	—	—	—	0.016
Decor 185x185/125G	186	142	15	45	125	—	0.0113
Decor 250x250G	250	214	15	—	—	—	0.0177-0.056
Decor 250x250/150G	250	214	15	41	150	—	0.0177-0.056

GM

METAL GRAVITY GRILLES

Features

- Outer wall mounting
- Decoration of ventilation shaft vents
- The grille frame is made of grey polymer coated steel
- Equipped with louvre shutters made of deformation-resistant plastic for back flow prevention
- Screw fixing, flush mounting possible
- Easy maintenance



Overall dimensions

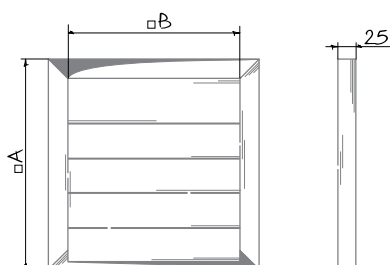

Model	Dimensions [mm]		Weight [kg]
	A	B	
GM 200	200	150	0.4
GM 250	250	200	0.54
GM 285	284	234	0.56
GM 300	300	250	0.68
GM 335	334	284	0.72
GM 350	350	300	0.82
GM 385	384	334	0.87
GM 400	400	350	0.97
GM 435	434	384	1.02
GM 450	450	400	1.11
GM 485	484	434	1.17
GM 535	534	484	1.32
GM 585	584	534	2.22
GM 635	634	584	2.46
GM 715	714	664	3.86



DECOR-M

METAL GRILLES

Features

- Wall or ceiling mounting
- Decoration of ventilation shaft vents
- Made of aluminium with paintable surface
- Screw fixing
- Equipped with a protecting insect screen (s)
- Easy maintenance



white



grey



beige



brown



Overall dimensions

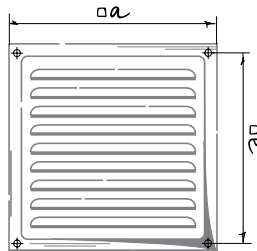

Model	Dimensions [mm]		Air pass [m ²]
	a	e	
Decor-M 125x125s A colour*	125	111	0.0035
Decor-M 150x150s A colour*	150	136	0.006
Decor-M 200x200s A colour*	200	182	0.0117
Decor-M 250x250s A colour*	250	234	0.0166
Decor-M 300x300s A colour*	300	284	0.0249

* colour – Grille color

VDA CFn AL

METAL GRILLES

Features

- Decoration of exhaust vents of in residential, public and industrial buildings.
- For ventilation, air conditioning and heating systems.
- Outer wall mounting.
- Made of cast aluminium.
- The round spigot enables connection to a round air duct.
- A large-mesh protecting stainless steel screen.
- Fixing to the air ducts with screws.



Overall dimensions

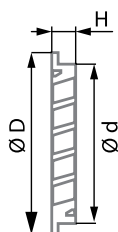

Model	Dimensions [mm]			Air pass [m ²]
	Ø D	Ø d	H	
VDA 100 CFn AL	125	100	20	0.00053
VDA 125 CFn AL	150	125	20	0.00076
VDA 150 CFn AL	180	150	18	0.0011
VDA 160 CFn AL	185	160	18	0.00125
VDA 200 CFn AL	225	200	20	0.00195
VDA 250 CFn AL	275	250	20	0.0029
VDA 315 CFn AL	350	315	20	0.0045
VDA 400 CFn AL	440	400	40	0.0075

DECOR

PLASTIC GRILLES

Features

- o Wall or ceiling mounting
- o Decoration of ventilation shaft vents or for connection to round air ducts
- o Temperature- and UV-resistant antistatic plastic
- o Flush mounting is possible
- o Flush mounted fasteners
- o Equipped with a protecting insect screen (s)
- o Easy maintenance



Options

Without flange



Flange

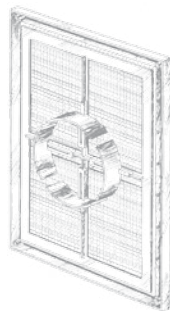

Model	Basic Model	Flange
Decor 182x251s	•	
Decor 182x251/Vs		•
Decor 205x205s	•	
Decor 205x205/Vs		•

Overall dimensions

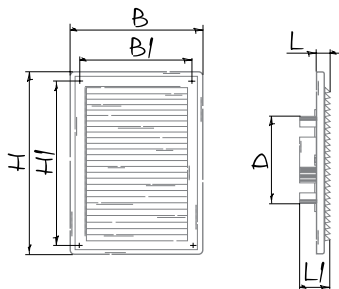

Model	Dimensions [mm]						Ø D	Air pass [m ²]
	H	B	H1	B1	L	L1		
Decor 182x251s	251	182	226	157	16	-	-	0.0127
Decor 182x251/Vs	251	182	226	157	16	41	100-150	0.0127
Decor 205x205s	204	204	179	179	16	-	-	0.092
Decor 205x205/Vs	204	204	179	179	16	41	100-1500	0.092

DECOR

PLASTIC GRILLES

Features

- Wall mounting
- Easy maintenance
- For connection to rectangular or round air ducts
- Temperature- and UV-resistant antistatic plastic
- Equipped with a protecting insect screen (s)



Options

Rectangular flange



Round flange for connection to round air ducts

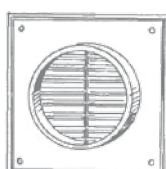

For exhaust ventilation and back flow prevention



Manual adjustment of air pass

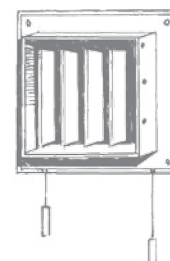

Without flange



Without flange
Manual regulator



Without flange
Manual regulator



Model	Basic Model	Flange	Louver shutters	Manual adjustment	Without flange
Decor 140x140s	•				
Decor 140x140/100s		•			
Decor 140x140Bs					•
Decor 140x140Gs			•		
Decor 140x140Rs				•	
Decor 140x140BRs				•	•
Decor 180x180s	•				
Decor 180x180/125s		•			
Decor 180x180Bs					•
Decor 180x180Gs			•		
Decor 180x180Rs				•	
Decor 180x180BRs				•	•
Decor 180x250s	•				
Decor 180x250Bs					•
Decor 180x250Gs			•		
Decor 180x250Rs				•	
Decor 180x250BRs				•	•
Decor 140x300s	•				
Decor 140x300Gs			•		
Decor 140x300Rs				•	

DECOR

PLASTIC GRILLES

Overall dimensions and mounting

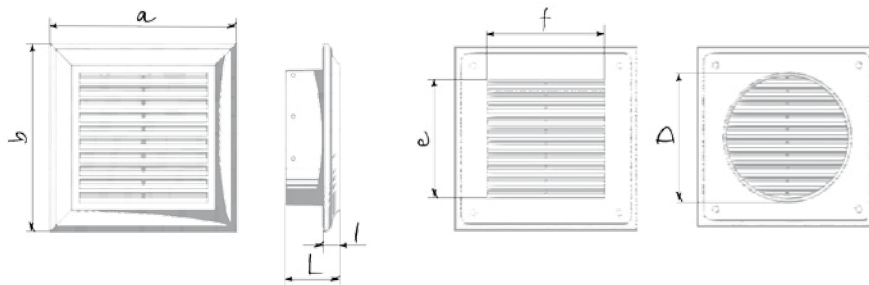

Model	Dimensions [mm]				e x f	Ø D	Air pass [m²]
	a	b	L	l			
Decor 140x140s	140	140	40.5	12.5	100 x 100	-	0.0053
Decor 140x140/100s	140	140	40.5	12.5	100 x 100	100	0.0043
Decor 140x140Bs	140	140	-	12.5	100 x 100	-	0.0053
Decor 140x140Gs	140	140	40.5	12.5	100 x 100	-	0.0053
Decor 140x140Rs	140	140	40.5	12.5	100 x 100	-	0.0053
Decor 140x140BRs	140	140	-	12.5	100 x 100	-	0.0053
Decor 180x180s	180	180	40.6	12.6	138 x 138	-	0.0091
Decor 180x180/125s	180	180	40.6	12.6	138 x 138	125	0.0059
Decor 180x180Bs	180	180	-	12.6	138 x 138	-	0.0091
Decor 180x180Gs	180	180	40.6	12.6	138 x 138	-	0.0091
Decor 180x180Rs	180	180	40.6	12.6	138 x 138	-	0.0091
Decor 180x180BRs	180	180	-	12.6	138 x 138	-	0.0091
Decor 180x250s	180	250	40.6	12.6	138 x 208	-	0.0146
Decor 180x250Bs	180	250	-	12.6	138 x 208	-	0.0146
Decor 180x250Gs	180	250	40.6	12.6	138 x 208	-	0.0146
Decor 180x250Rs	180	250	40.6	12.6	138 x 208	-	0.0146
Decor 180x250BRs	180	250	-	12.6	138 x 208	-	0.0146
Decor 140x300s	140	300	40.6	12.6	100 x 255	-	0.0128
Decor 140x300Gs	140	300	40.6	12.6	100 x 255	-	0.0128
Decor 140x300Rs	140	300	40.6	12.6	100 x 255	-	0.0128

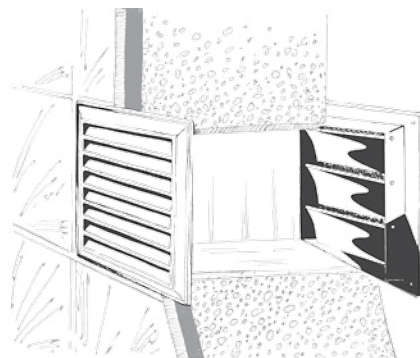

DECOR

PLASTIC GRILLES

Features

- Wall or ceiling mounting
- Connection to round air ducts
- Temperature- and UV-resistant antistatic plastic
- Equipped with a protecting insect screen (s)
- Easy maintenance



Overall dimensions and mounting

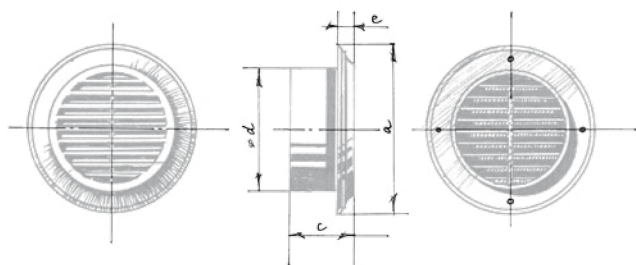

Model	Dimensions [mm]				Air pass [m ²]
	a	c	Ø d	e	
Decor 80s	123	42	80	14	0.0033
Decor 100s	140	42	100	14	0.0048
Decor 125s	165	42	125	14	0.0073
Decor 150s	188	42	150	14	0.0106

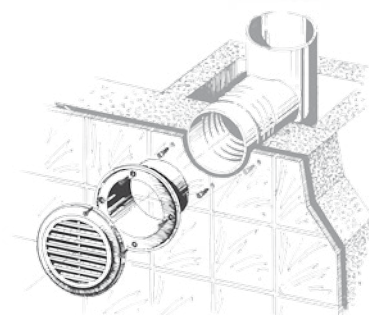
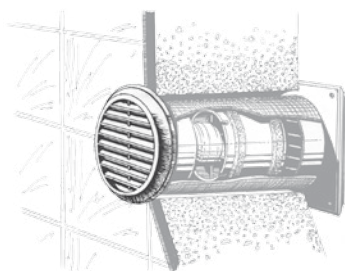

DECOR

PLASTIC GRILLES

Features

- o Wall or ceiling mounting
- o Easy maintenance
- o For connection to rectangular air ducts BlauPlast FK series
- o Temperature- and UV-resistant antistatic plastic



Options

- o Manual adjustment of air pass (R).

Overall dimensions and mounting

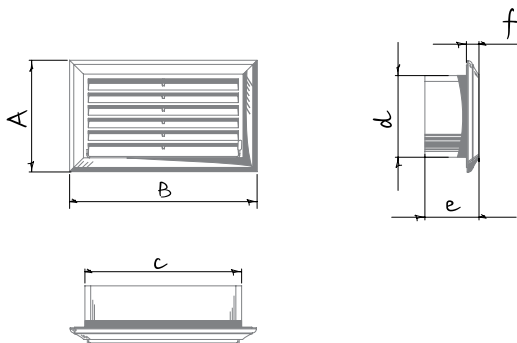

Model	Dimensions [mm]					
	A	B	c	d	e	f
Decor 81x136	81	136	114	59	42	12
Decor 81x136R	81	136	114	59	42	12
Decor 86x230	86	230	208	64	42	12
Decor 86x230R	86	230	208	64	42	12

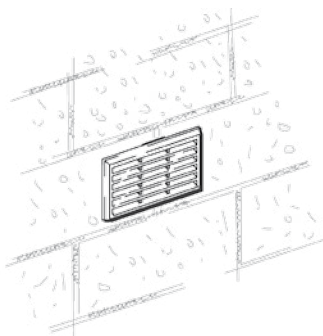

VMR

METAL AIR DISC VALVES

Features

- Ceiling or wall mounting
- Smooth air flow control
- Easy mounting with a mounting flange
- Sealing ring
- Made of white polymer coated steel



Overall dimensions and mounting

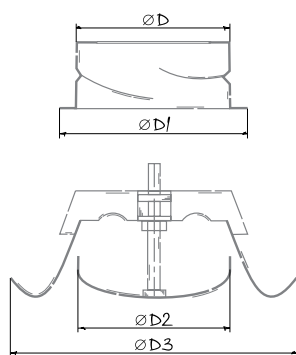

Model	Dimensions [mm]			
	Ø D	Ø D1	Ø D2	Ø D3
VMR 100	99	123	75	128
VMR 125	124	152	100	154
VMR 150	149	173	128	184
VMR 200	199	225	178	235

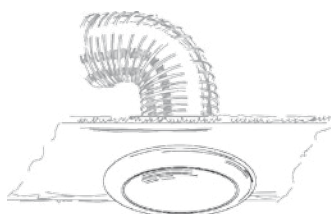

Technical data

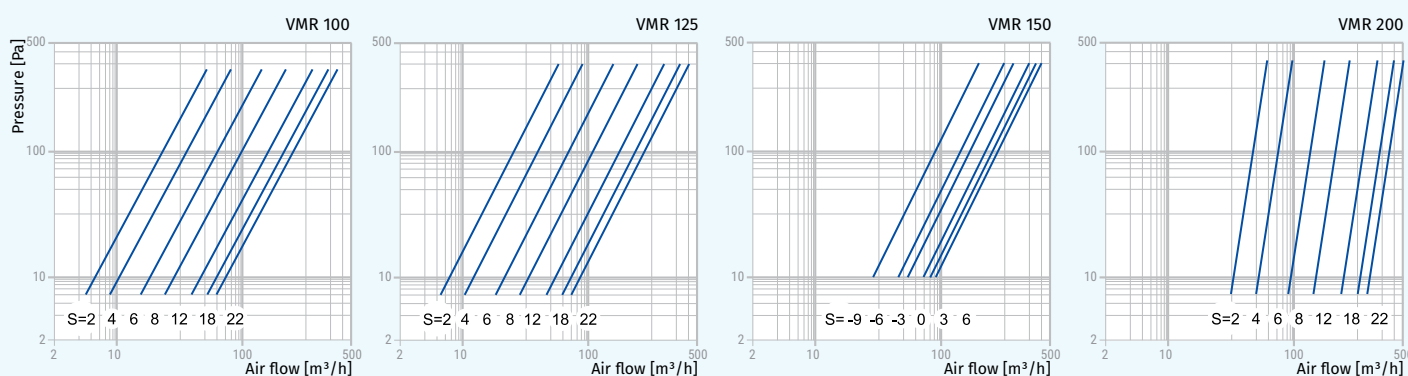

VMBR

METAL AIR DISC VALVES

Features

- For supply ventilation, air conditioning and heating.
- Designed for wall mounting or installation into false ceiling.
- Used to arrange correct air supply and circulation in premises.
- Made of polymer-coated steel.
- Special aerodynamic disk valve design ensures uniform air distribution.
- Smooth air pass regulation due to rotation of central part of the damper.
- Equipped with a mounting flange for easy connection to round \varnothing 100-200 mm air ducts.
- Mounting flange is fixed to false ceiling with screws.
- The internal part has a sealing ring for more tight fit.



Overall dimensions and mounting

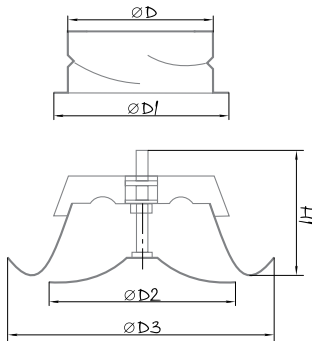

Model	Dimensions [mm]				
	$\varnothing D$	$\varnothing D1$	$\varnothing D2$	$\varnothing D3$	H1
VMBR 100	99	125	88	138	60
VMBR 125	124	150	112	167	60
VMBR 150	149	175	144	199	70
VMBR 200	199	225	200	249	70

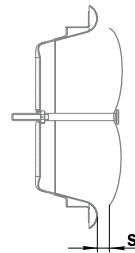
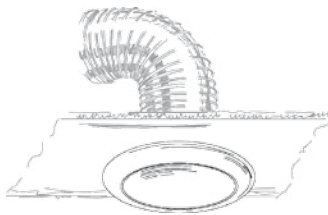

The internal part of the air disk valve is pulled out to ensure the required clearance S (mm) to provide required air flow according to the diagram.

Technical data

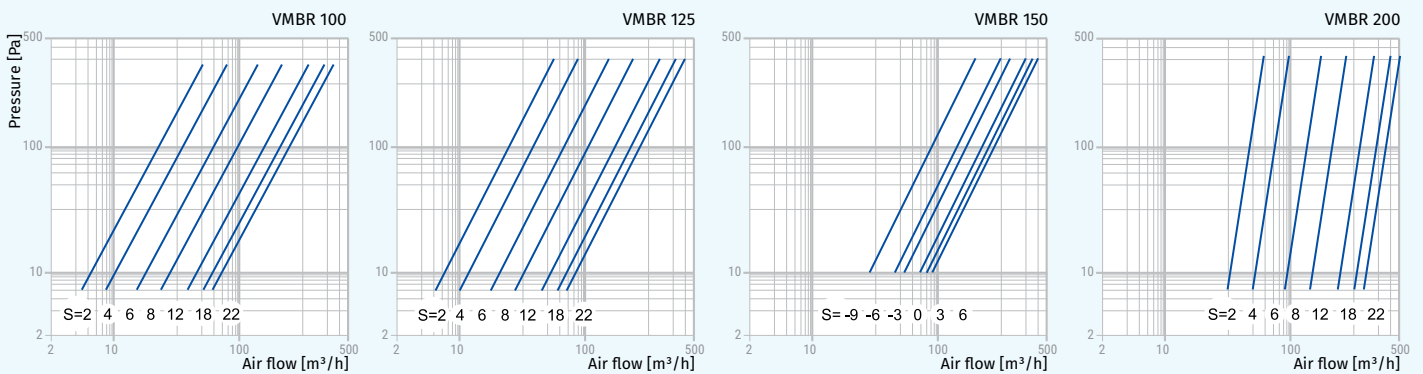

VSR

METAL AIR DISC VALVES

Features

- Ceiling or wall mounting
- Smooth air flow control
- Easy mounting with a mounting flange
- Equipped with a sealing ring
- Made of stainless steel



Overall dimensions and mounting

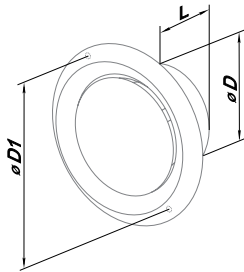

Model	Dimensions [mm]			Air pass [m ²]
	Ø D	Ø D1	Ø L	
VSR 100	97	118	52	0.0032
VSR 125	120	141	52	0.0057
VSR 150	145	162	62	0.009

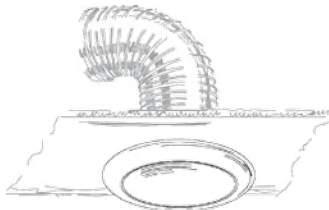

VPR

PLASTIC AIR DISC VALVES

Features

- o Ceiling or wall mounting
- o Smooth air flow control
- o Easy installation with a mounting flange
- o Sealing ring
- o Temperature- and UV-resistant antistatic plastic



Overall dimensions and mounting

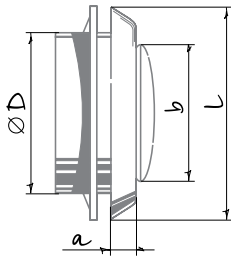

Model	Dimensions [mm]			Ø D	Air pass [m ²]
	a	b	l		
VPR 80	18	90	132	80	0...0.002
VPR 100	18	90	148	100	0...0.006
VPR 125	20	110	166	125	0...0.008
VPR 150	20	128	200	150	0...0.009
VPR 200	20	128	246	200	0.001...0.008

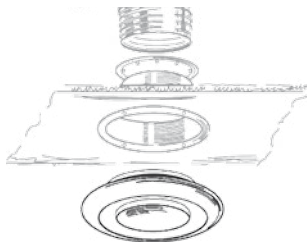

Technical data

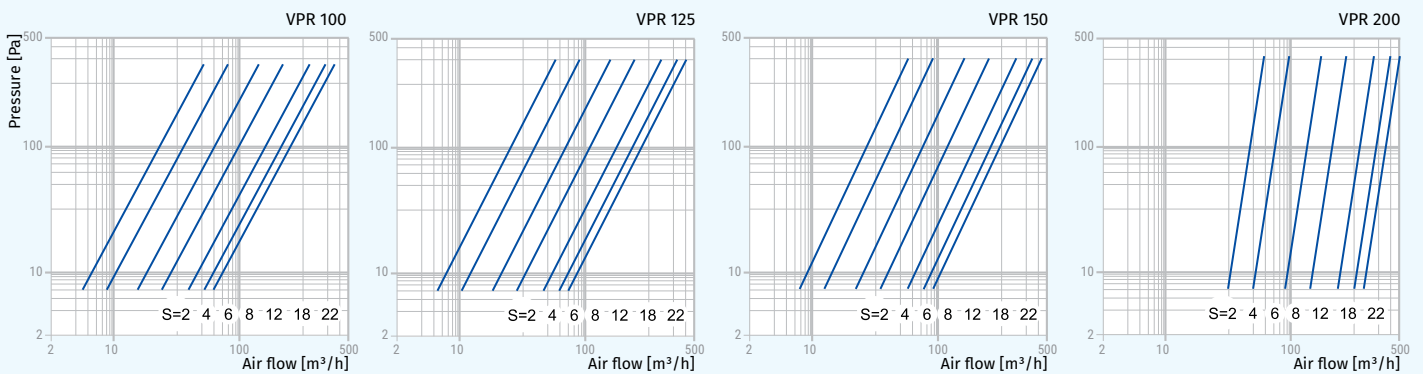

DECOR-A

ALUMINIUM DOOR GRILLES

Features

- For mounting in door leaves of bathrooms and kitchens
- Made of aluminium
- Available with white polymer coating (Model **Decor-A...white**)
- Minimum door leaf thickness is 34 mm
- Direct fixation to the door leaf with spacing lugs
- Easy maintenance

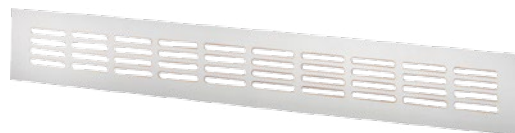

Overall dimensions

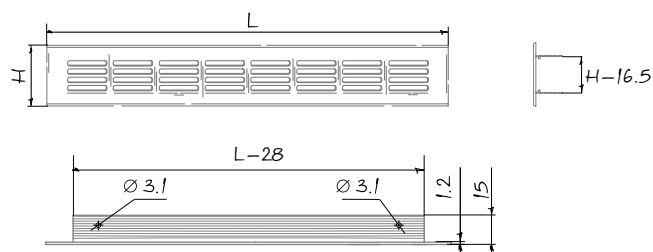

Model	Dimensions [mm]		Air pass [m ²]
	L	H	
Decor-A 400x60	400	60	0.0062
Decor-A 400x80	400	80	0.0093
Decor-A 400x100	400	100	0.012
Decor-A 500x60	500	60	0.0078
Decor-A 500x80	500	80	0.012
Decor-A 500x100	500	100	0.0156
Decor-A 600x60	600	60	0.0093
Decor-A 600x80	600	80	0.014
Decor-A 600x100	600	100	0.0186
Decor-A 800x60	800	60	0.012
Decor-A 800x80	800	80	0.0186
Decor-A 800x100	800	100	0.0248
Decor-A 1000x60	1000	60	0.016
Decor-A 1000x80	1000	80	0.0256
Decor-A 1000x100	1000	100	0.0326

DECOR T

PLASTIC DOOR GRILLES

Features

- o For mounting in door leaves of bathrooms and kitchens
- o Easy maintenance
- o Temperature- and UV-resistant antistatic plastic
- o Direct fixation to the door leaf with screws



Overall dimensions [mm]

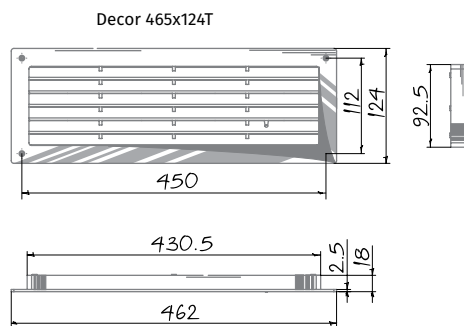
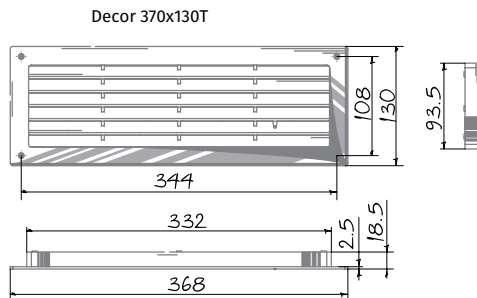

DECOR T-2

PLASTIC DOOR GRILLES

Features

- Two-element grilles for mounting in door leaves of bathrooms and kitchens
- Minimum door leaf thickness is 30 mm
- Easy maintenance
- Temperature- and UV-resistant antistatic plastic
- Direct fixation to the door leaf with screws



Overall dimensions [mm]

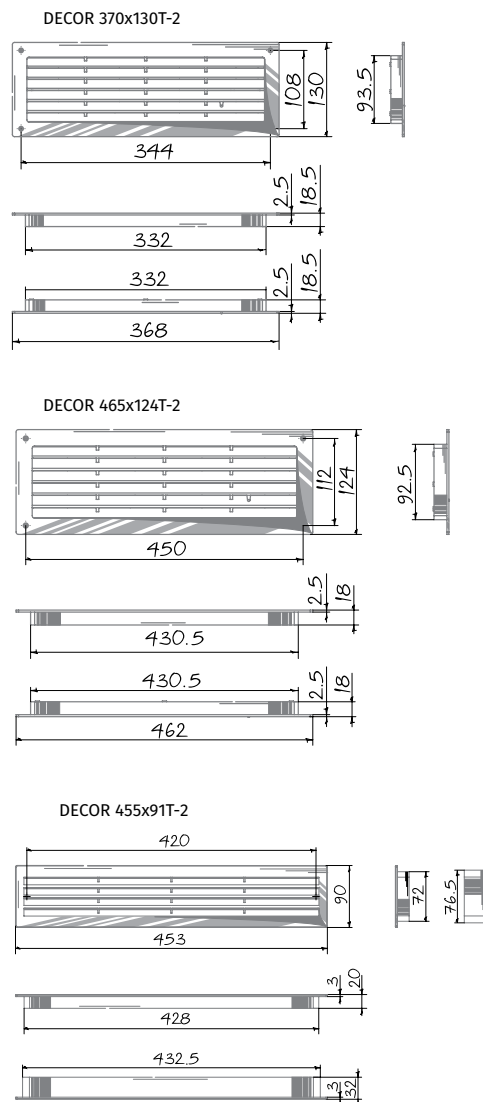

DECOR 380X104T-2

PLASTIC DOOR GRILLES

Features

- Two-element grilles for mounting in door leaves of bathrooms and kitchens
- The grille parts are connected through slots and fixed with screws
- Minimum door leaf thickness is 29 mm
- Easy maintenance
- Temperature- and UV-resistant antistatic plastic



Overall dimensions [mm]

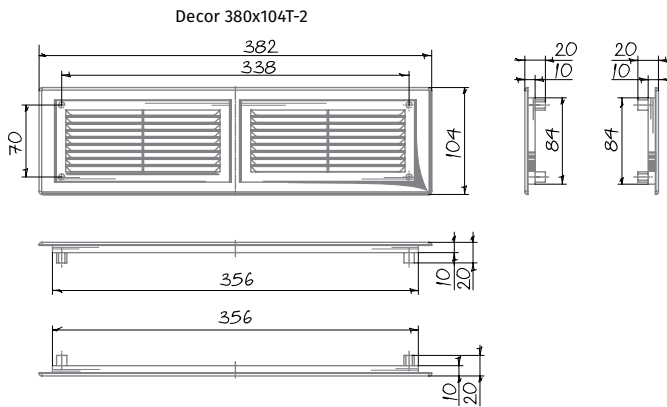

DECOR 60/47S-4

PLASTIC DOOR GRILLES

Features

- For mounting in door leaves of bathrooms and kitchens
- Suitable for installation in furniture for extra ventilation of internal space
- Temperature- and UV-resistant antistatic plastic
- Wide range of colours
- Fixing with mounting ribs or glue
- Supplied as a set (4 pcs)
- Equipped with a protecting insect screen (s)
- Easy maintenance



Overall dimensions and mounting

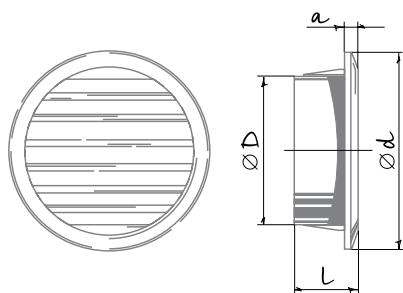

Model	Dimensions [mm]				Air pass [m ²]
	Ø D	Ø d	l	a	
Decor 60/47s-4	59	47	165	35	0.0078

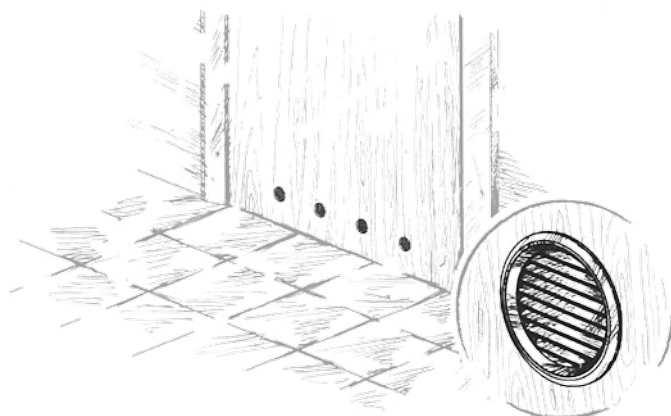

RT/RTV

ACCESS DOORS

Features

- o Wall or ceiling mounting
- o Suitable for use in humid areas
- o High quality UV-resistant ABS plastic
- o Versatile mounting enables left- and right-side opening
- o Installation with mortar or glue
- o Easy maintenance



Options

- o RTV 15x30, RTV 25x40, RTV 30x50, RTV 30x60, RTV 40x50, RTV 40x60 - access doors with a lock for access control

Overall dimensions and mounting

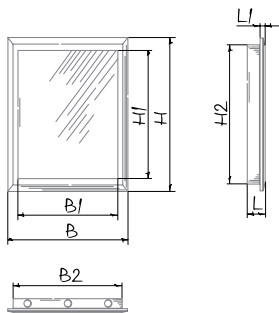

Model	Dimensions [mm]							
	H	B	H1	B1	H2	L1	L	B2
RT(V) 10x10	137	137	93	93	98	5	25	98
RT(V) 15x15	167	167	123	123	147	5	25	147
RT(V) 15x20	217	167	173	123	197	5	25	147
RT(V) 15x30	317	167	273	123	297	5	25	147
RT(V) 20x20	217	217	173	173	197	5	25	197
RT(V) 20x25	267	217	223	173	247	5	25	197
RT(V) 20x30	317	217	273	173	297	5	25	197
RT(V) 20x40	417	217	373	173	397	5	25	197
RT(V) 25x30	347	267	303	223	327	5	25	247
RT(V) 25x40	417	267	373	223	397	5	25	247
RT(V) 30x30	317	317	273	273	297	5	25	297
RT(V) 30x40	417	317	373	273	397	5	25	297
RT(V) 30x50	517	317	473	273	497	5	25	297
RT(V) 30x60	617	317	573	273	597	5	25	297
RT(V) 40x50	517	417	473	373	497	5	25	397
RT(V) 40x60	617	417	573	373	597	5	25	397



RTZ

ACCESS DOORS

Features

- Wall or ceiling mounting
- Suitable for use in humid areas
- High quality UV-resistant ABS plastic
- Versatile mounting enables left- and right-side opening
- Installation with mortar or glue
- Easy maintenance
- Specially treated surface for acrylic or water dispersion paints or wall papers



Overall dimensions and mounting

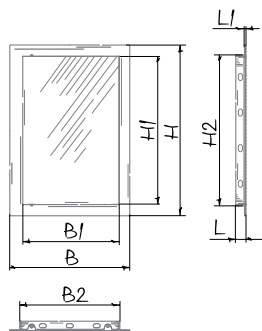

Model	Dimensions [mm]							
	H	B	H1	B1	H2	L1	L	B2
RTZ 20x30	336	236	291	189	297	3	20	197

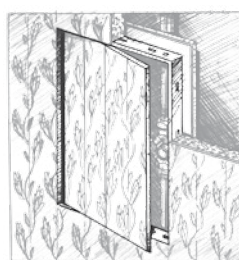
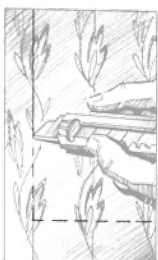

RTMG

ACCESS DOORS

Features

- o Plastic handle for easy opening and closing of the door
- o Wall mounting
- o High quality steel with durable white polymer coating
- o Special corrosion-resistant treatment
- o Versatile mounting enables left- and right-side opening
- o Installation with mortar or glue
- o Easy maintenance



Overall dimensions and mounting

Model	Dimensions [mm]						
	H	B	H1	B2	H2	B1	L
RTMG 100x100	136.5	136.5	96.5	98.1	98.1	96.5	25
RTMG 150x150	186.5	186.5	146.5	148.1	148.1	146.5	25
RTMG 150x200	236.5	186.5	196.5	148.1	198.1	146.5	25
RTMG 150x250	286.5	186.5	246.5	148.1	248.1	146.5	25
RTMG 150x300	336.5	186.5	296.5	148.1	298.1	146.5	25
RTMG 200x200	236.5	236.5	196.5	198.1	198.1	196.5	25
RTMG 200x250	286.5	236.5	246.5	198.1	248.1	196.5	25
RTMG 200x300	336.5	236.5	296.5	198.1	298.1	196.5	25
RTMG 200x350	386.5	236.5	346.5	198.1	348.1	196.5	25
RTMG 200x400	436.5	236.5	396.5	198.1	398.1	196.5	25
RTMG 225x300	336.5	261.5	296.5	223.1	298.1	221.5	25
RTMG 225x590	626.5	261.5	586.5	223.1	588.1	221.5	25
RTMG 250x250	286.5	286.5	246.5	248.1	248.1	246.5	25
RTMG 250x300	336.5	286.5	296.5	248.1	298.1	246.5	25
RTMG 250x350	386.5	286.5	346.5	248.1	348.1	246.5	25
RTMG 250x400	436.5	286.5	396.5	248.1	398.1	246.5	25
RTMG 250x450	486.5	286.5	446.5	248.1	448.1	246.5	25
RTMG 300x200	236.5	336.5	196.5	298.1	198.1	296.5	25
RTMG 300x300	336.5	336.5	296.5	298.1	298.1	296.5	25
RTMG 300x400	436.5	336.5	396.5	298.1	398.1	296.5	25
RTMG 300x500	536.5	336.5	496.5	298.1	498.1	296.5	25
RTMG 300x600	636.5	336.5	596.5	298.1	598.1	296.5	25
RTMG 350x350	386.5	386.5	346.5	348.1	348.1	346.5	25
RTMG 400x400	436.5	436.5	396.5	398.1	398.1	396.5	25
RTMG 400x500	536.5	436.5	496.5	398.1	498.1	396.5	25
RTMG 400x600	636.5	436.5	596.5	398.1	598.1	396.5	25
RTMG 450x250	286.5	486.5	246.5	448.1	248.1	446.5	25
RTMG 450x450	486.5	486.5	446.5	448.1	448.1	446.5	25
RTMG 500x500	536.5	536.5	496.5	498.1	498.1	496.5	25
RTMG 500x600	636.5	536.5	596.5	498.1	598.1	496.5	25
RTMG 500x800	836.5	536.5	796.5	498.1	798.1	496.5	25
RTMG 555x555	591.5	591.5	551.5	553.1	553.1	551.5	25
RTMG 600x400	436.5	636.5	396.5	598.1	398.1	596.5	25
RTMG 600x600	636.5	636.5	596.5	598.1	598.1	596.5	25
RTMG 600x800	836.5	636.5	796.5	598.1	798.1	596.5	25

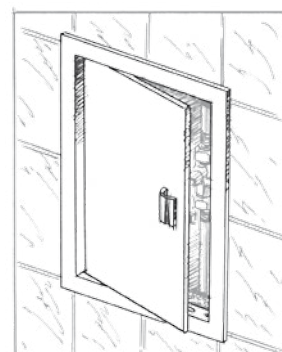
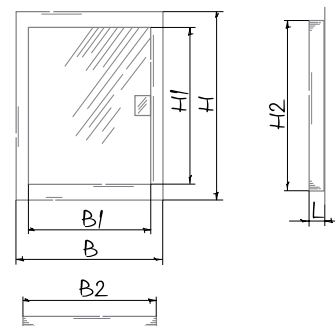

RTMV

ACCESS DOORS

Features

- Access doors with a lock for access control
- Wall mounting
- High quality steel with durable white polymer coating
- Special corrosion-resistant treatment
- Versatile mounting enables left- and right-side opening
- Installation with mortar or glue
- Easy maintenance



Overall dimensions and mounting

Model	Dimensions [mm]						
	H	B	H1	B2	H2	B1	L
RTMV 100x100	136.5	136.5	96.5	98.1	98.1	96.5	25
RTMV 150x150	186.5	186.5	146.5	148.1	148.1	146.5	25
RTMV 150x200	236.5	186.5	196.5	148.1	198.1	146.5	25
RTMV 150x250	286.5	186.5	246.5	148.1	248.1	146.5	25
RTMV 150x300	336.5	186.5	296.5	148.1	298.1	146.5	25
RTMV 200x200	236.5	236.5	196.5	198.1	198.1	196.5	25
RTMV 200x250	286.5	236.5	246.5	198.1	248.1	196.5	25
RTMV 200x300	336.5	236.5	296.5	198.1	298.1	196.5	25
RTMV 200x350	386.5	236.5	346.5	198.1	348.1	196.5	25
RTMV 200x400	436.5	236.5	396.5	198.1	398.1	196.5	25
RTMV 200x500	536.5	236.5	496.5	198.1	498.1	196.5	25
RTMV 225x300	336.5	261.5	296.5	223.1	298.1	221.5	25
RTMV 225x590	626.5	261.5	586.5	223.1	588.1	221.5	25
RTMV 250x250	286.5	286.5	246.5	248.1	248.1	246.5	25
RTMV 250x300	336.5	286.5	296.5	248.1	298.1	246.5	25
RTMV 250x350	386.5	286.5	346.5	248.1	348.1	246.5	25
RTMV 250x400	436.5	286.5	396.5	248.1	398.1	246.5	25
RTMV 250x450	486.5	286.5	446.5	248.1	448.1	246.5	25
RTMV 300x200	236.5	336.5	196.5	298.1	198.1	296.5	25
RTMV 300x300	336.5	336.5	296.5	298.1	298.1	296.5	25
RTMV 300x400	436.5	336.5	396.5	298.1	398.1	296.5	25
RTMV 300x500	536.5	336.5	496.5	298.1	498.1	296.5	25
RTMV 300x600	636.5	336.5	596.5	298.1	598.1	296.5	25
RTMV 350x350	386.5	386.5	346.5	348.1	348.1	346.5	25
RTMV 400x400	436.5	436.5	396.5	398.1	398.1	396.5	25
RTMV 400x500	536.5	436.5	496.5	398.1	498.1	396.5	25
RTMV 400x600	636.5	436.5	596.5	398.1	598.1	396.5	25
RTMV 450x250	286.5	486.5	246.5	448.1	248.1	446.5	25
RTMV 450x450	486.5	486.5	446.5	448.1	448.1	446.5	25
RTMV 500x500	536.5	536.5	496.5	498.1	498.1	496.5	25
RTMV 500x600	636.5	536.5	596.5	498.1	598.1	496.5	25
RTMV 500x800	836.5	536.5	796.5	498.1	798.1	496.5	25
RTMV 555x555	591.5	591.5	551.5	553.1	553.1	551.5	25
RTMV 600x400	436.5	636.5	396.5	598.1	398.1	596.5	25
RTMV 600x600	636.5	636.5	596.5	598.1	598.1	596.5	25
RTMV 600x800	836.5	636.5	796.5	598.1	798.1	596.5	25

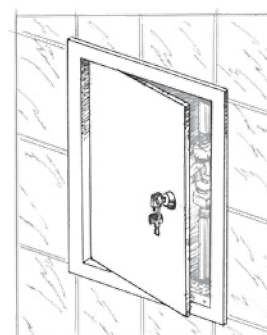
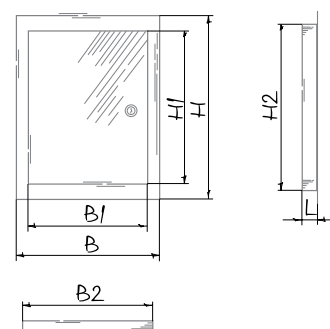

RT2

ACCESS DOORS

Features

- Wall or ceiling mounting
- Suitable for use in humid areas
- High quality UV-resistant ABS plastic
- Installation with mortar or glue
- Easy maintenance
- Wide access to utility lines due to swing door design



Overall dimensions and mounting

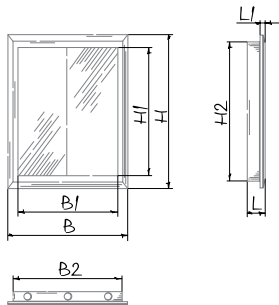

Model	Dimensions [mm]							
	H	B	H1	B1	H2	L1	L	B2
RT2 40x40	416	388	372	344	397	5	25	370

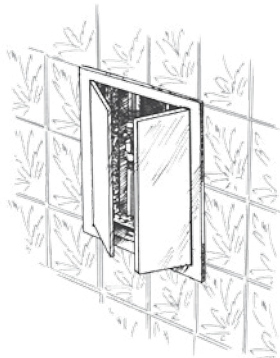

RTF

ACCESS DOORS

Features

- Wall flush mounting
- PVC frame has magnets and conceals tile-to-tile gap
- Metal plate for fixing of ceramic tiles
- Magnet fixation of plate to frame allows proper adjustment to tile position
- Easy fixing of ceramic tiles to plate with glue
- Suitable for use in humid areas
- Easy mounting with spacing lugs
- Easy maintenance



Overall dimensions and mounting

Model	Dimensions [mm]						
	B	H	B2	H2	B1	H1	L
RTF 150x150	156	156	145	145	153	153	30
RTF 150x200	156	206	145	195	153	203	30
RTF 150x250	156	256	145	245	153	253	30
RTF 150x300	156	306	145	295	153	303	30
RTF 200x200	206	206	195	195	203	203	30
RTF 200x250	206	256	195	245	203	253	30
RTF 200x300	206	306	195	295	203	303	30
RTF 200x350	206	356	195	345	203	353	30
RTF 200x400	206	406	195	395	203	403	30
RTF 200x450	206	456	195	445	203	453	30
RTF 200x500	206	506	195	495	203	503	30
RTF 250x250	256	256	245	245	253	253	30
RTF 250x300	256	306	245	295	253	303	30
RTF 250x350	256	356	245	345	253	353	30
RTF 250x400	256	406	245	395	253	403	30
RTF 300x300	306	306	295	295	303	303	30
RTF 300x350	306	356	295	345	303	353	30
RTF 300x400	306	406	295	395	303	403	30
RTF 300x450	306	456	295	445	303	453	30
RTF 300x500	306	506	295	495	303	503	30
RTF 400x400	406	406	395	395	403	403	30

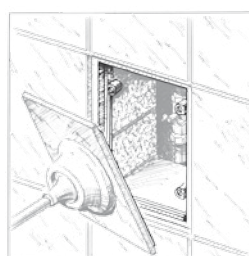
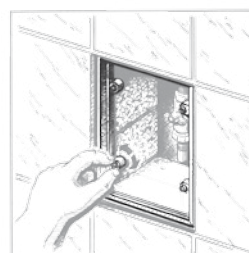
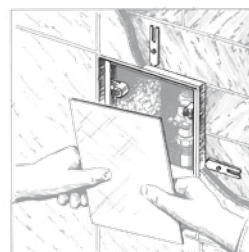
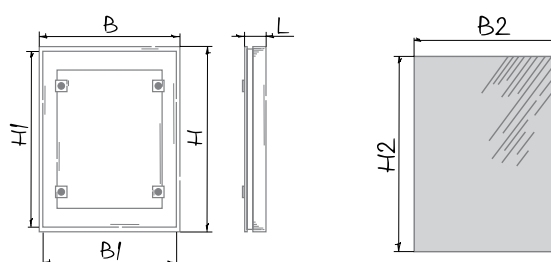

CDT E1.8

THYRISTOR SPEED CONTROLLERS

Features

- For switching fans on/off and for speed control of single-phase frequency controlled motors For ventilation systems in various premises
- The casing is made of high-quality plastic
- Mounting junction box for wall flush mounting
- Input circuit protected with a thermal fuse
- Equipped with a transient filter
- Mounting box EDR-E for wall surface mounting available upon separate order



Control

- Switching on/off by the control knob.
- Smooth speed control from minimum to maximum value. Minimum speed is set by a variable resistor on the control panel.
- Several fans can be controlled from one unit provided that the total current consumption does not exceed the permissible controller current.
- High efficiency and control accuracy.

Technical data

Model	CDT E1.8
Voltage [V/Hz]	1~230/50 (60)
Rated current [A]	1.8
Dimensions W × H × D [mm]	80 × 80 × 63
Max operating temperature [°C]	35



Mounting

- Indoor wall flush mounting in a mounting box.
- Suitable for installation in standard electric junction boxes.

Wiring diagram

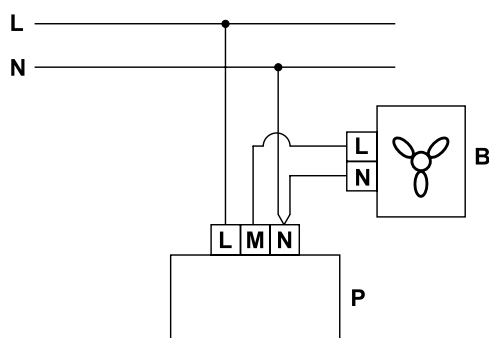

CDTE E1.8

THYRISTOR SPEED CONTROLLERS

Features

- For switching fans on/off and for speed control of single-phase frequency controlled motors. For ventilation systems in various premises
- Casing made of high-quality plastic
- Surface box for mounting
- Input circuit protected with a thermal fuse
- Equipped with a transient filter



Control

- Switching on/off by control knob.
- Smooth speed control from minimum to maximum value. The minimum rotation speed is set by a variable resistor on the control panel.
- Several fans can be controlled from one unit provided that the total current consumption does not exceed the permissible controller current.
- Featured with high efficiency and control accuracy.

Technical data

Model	CDTE E1.8
Voltage [V/Hz]	1~230/50 (60)
Rated current [A]	1.8
Dimensions W × H × D [mm]	80 × 80 × 63
Max operating temperature [°C]	35



Mounting

- Indoor wall mounting.

Wiring diagram

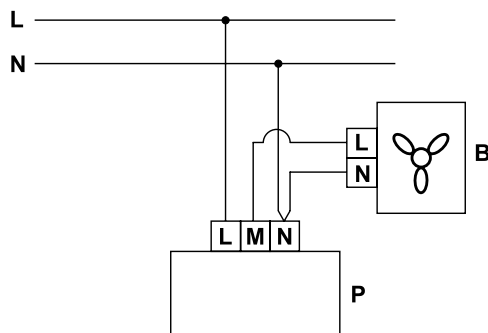

SGR-3/1

MULTI-SPEED SWITCHES

Features

- On/off switch and speed selection for multi-speed fans
- Casing made of high-quality plastic
- Glass sensor operating panel with three touch buttons for speed selection with light indication
- Wall flush mounting



Control

- Required speed is activated by touching the respectively marked speed button.
- The fan is turned off by touching the current speed button.

Mounting

- Designed for wall mounting in a flush mounting box.

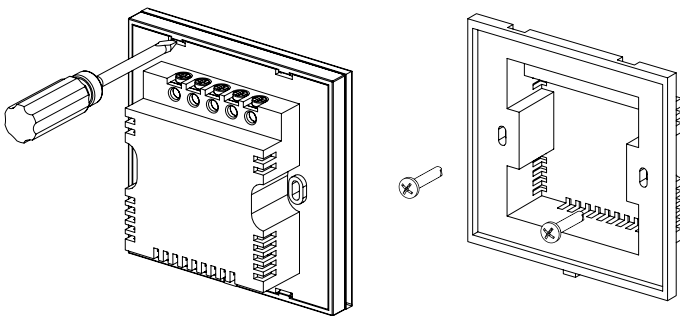

Wiring diagram

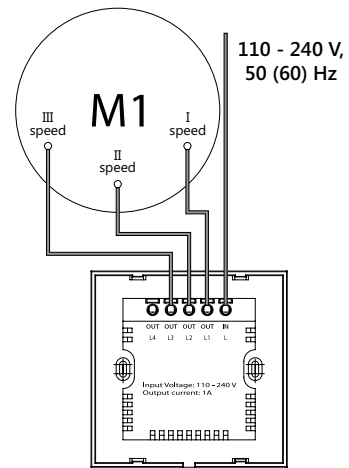

Overall dimensions [mm]

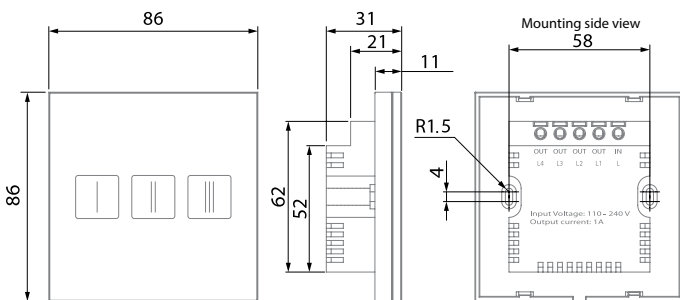

Technical data

Model	SGR-3/1
Voltage [V/Hz]	110-240/50 (60)
Max current load [A]	1
Number of speeds	3
Cable cross section [mm ²]	from 0.35 up to 1
Temperature range [°C]	-10...+45
Operating humidity range [%]	from 5 up to 80 (no condensation)
Service life	100 000 operations
Weight [g]	138



CDP-2/5 / CDP-3/5

MULTI-SPEED SWITCHES

Features

- On/off switch and speed switch for multi-speed fans
- Casing made of high-quality plastic
- Flush wall mounting



Control

- Switching of fan speed according to diagram 1 and switching of fan speed in parallel with switching the light in the room, diagram 2.

Mounting

- Indoor wall flush mounting in a mounting box.
- Suitable for installation in standard electric junction boxes.

Technical data

Model	CDP-2/5	CDP-3/5
Voltage [V/Hz]	1~230/50	1~230/50
Max current load [A]	3	3
Number of speeds	2	3
Dimensions W × H × D [mm]	88 × 88 × 51	88 × 88 × 51
Max operating temperature [°C]	40	40



Wiring diagram

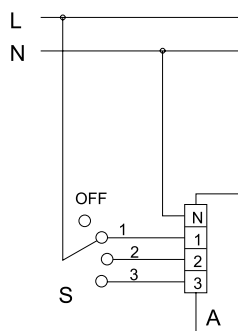

Diagram 1. The external switch S (CDP-3/5) switches the fan to one of three speeds and switches it off.

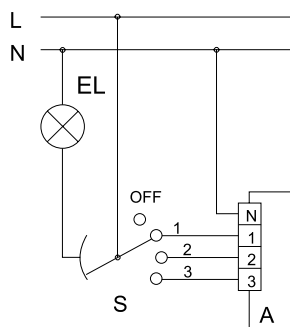

Diagram 2. The external switch S (CDP-3/5) switches the fan to one of three speeds and switches it off with parallel switching on/off the light in the room

CDP-2/10

MULTI-SPEED SWITCHES

Features

- Speed on/off switch and speed changeover for multi-speed fans
- Wall mounting in a flush mounting box
- Suitable for installation in standard electric junction boxes



Control

- Direct fan speed switching.

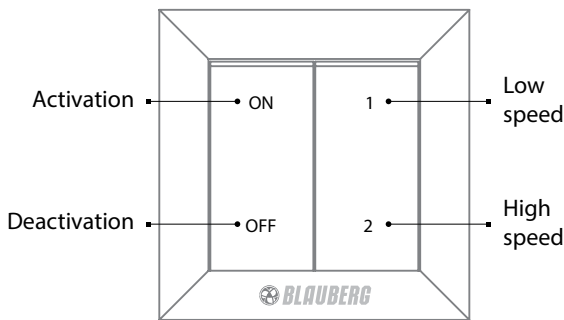

Wiring diagram

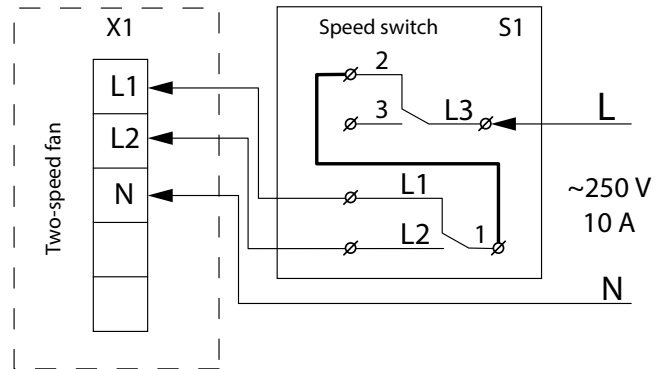

Overall dimensions [mm]

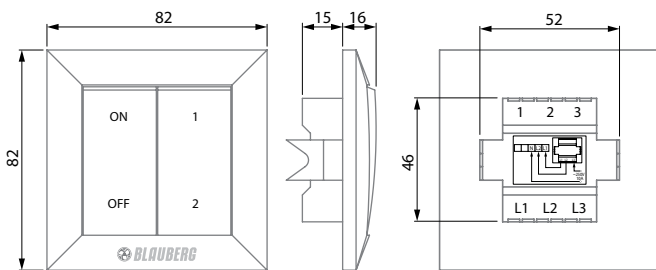

Technical data

Model	CDP-2/10
Voltage [V/Hz]	250/50 (60)
Max current load [A]	10
Cable cross section [mm ²]	from 0.35 up to 0.75
Temperature range [°C]	-10...+45
Operating humidity range [%]	from 5 up to 80 (no condensation)
Service life	100 000 switching operations
Weight [g]	98



CDPI-2(3) E5 / CDPE-2(3) E5

MULTI-SPEED SWITCHES

Features

- On/off switch and speed selection for multi-speed fans
- Casing made of high-quality plastic
- The casing includes an ON/OFF button, speed regulator and an operation light
- Wall flush mounting



Mounting

- CDPI-2(3) E5:** Designed for wall mounting in a flush mounting box.
- CDPE-2(3) E5:** Designed for wall surface mounting.

Wiring diagram

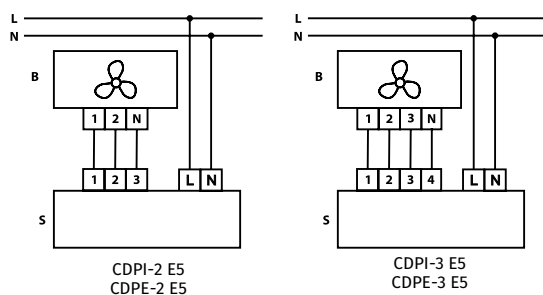

B - fan
S - switch

Technical data

Model	CDPI-2 E5	CDPI-3 E5
Voltage [V/Hz]	1~230/50	1~230/50
Rated current [A]	5	5
Number of speeds	2	3
Dimensions W × H × D [mm]	162 × 80 × 70	162 × 80 × 70
Max operating temperature [°C]	40	40
Weight [kg]	0.25	0.25



MCD 60/0.3

CONTROL UNIT FOR FANS

Features



- o Automatic regulation of residential fans.
- o Includes automatic control functions performed by timer, humidity sensor, photo sensor, motion sensor.
- o Control unit casing made of high-quality plastic.
- o Front panel equipped with light indicators. Display of control unit operation modes.
- o Equipped with a cord switch.



Modes and functions



RUN-OUT TIMER

Keeps the fan operating after switch-off within preset time period. Adjustable from 5 sec to 30 min.



INTERVAL TIMER

Switches the fan on/off. Operating cycle with time intervals from 5 sec to 30 min.



HUMIDITY SENSOR

Individually adjustable humidity set point. Switches the fan on when humidity level exceeds set point and switches the fan off when humidity level drops to set point.



PHOTO SENSOR

Automatically switches the fan on depending upon illumination level in the room due to the integrated photo switch. Two operation modes:

- o «Dark mode»: The control unit switches the fan on after light is turned off in the room. Operating period is adjustable from 5 sec up to 30 min. Photo sensor set point is adjustable from the control unit.
- o «Light mode»: The control unit switches the fan on after light is turned on in the room. After light is turned off the fan continues operating and is switched off by the run-out timer adjustable between 5 sec and 30 min. If light in the room is on more than 60 min the fan switches automatically off. The photo sensor set point is adjustable from the control unit.



MOTION SENSOR

Automatically switches the fan on in case of motion detection within the sensitivity area (operating distance 5 m, viewing angle 130°). The control unit switches the fan off after a preset time period from 5 sec to 30 min when no motion is detected.

Mounting

- o The control unit is designed for indoor wall surface installation close to the fan or remote installation.
- o For selecting the installation place consider motion sensor sensitivity area, furniture location and walking routes.

Control unit wiring diagram

- B - fan
- S1 - automatic circuit breaker
- S2 - external switch
- X - input terminal block BU

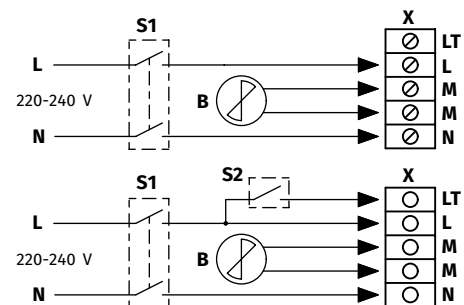

Technical data

Model	MCD 60/0.3
Voltage [V/Hz]	1~230/50
Max Load power [W]	60
Max current load [A]	0.3
Dimensions W × H × D [mm]	151 × 46 × 27
Max operating temperature [°C]	+40

TS E10

ROOM THERMOSTAT

Features

- For comfortable indoor temperature conditions and control of ventilation, heating and air conditioning systems
- Casing made of high-quality plastic
- Temperature regulator on front panel and switch for operation mode selection on side panel
- Supplied in casing for wall mounting



Control

- Temperature regulation range from +10 up to +30 °C
- The regulator has two operating patterns:
 - the contacts close when a temperature set point is reached and the fan turns on;
 - the contacts open when a temperature set point is reached and the fan turns off

Technical data

Model	TS E10
Voltage [V/Hz]	1~220-240/50 (60)
Dimensions W × H × D [mm]	84 × 84 × 35
Max operating temperature [°C]	40

IP40

Mounting

- Indoor wall surface installation in mounting box.
- Recommended installation height is 1.5 m above the floor level.
- Do not install the regulator close to windows, heating or cooling equipment.

Wiring diagram

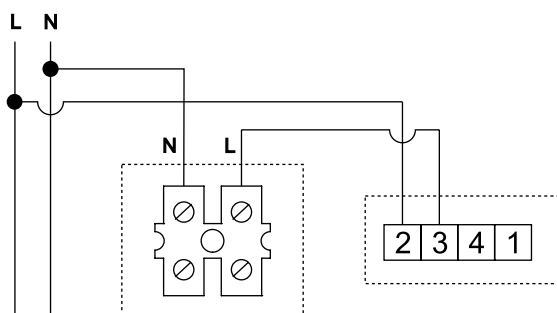

Fig.1. The fan operates until the temperature threshold set by the thermostat is reached

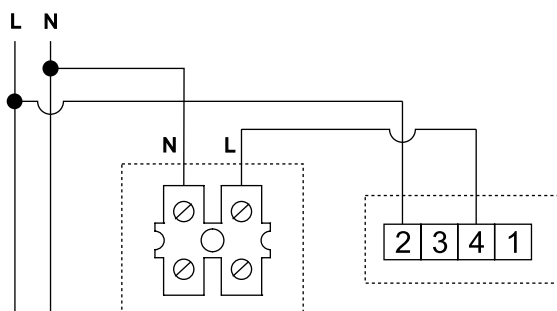

Fig.2. The fan turns on when the temperature threshold set by the thermostat is reached

MLC E2 / MLCD E2

ROOM TEMPERATURE REGULATORS

Features

- o Automatic or manual temperature control in ventilation and air conditioning systems installed in various premises.
- o Automatic regulation of heating/cooling rate.
- o Control of fans, fancoil dampers and air heating units equipped with three-speed 230 V fans.
- o Casing made of high-quality plastic.
- o Equipped with a temperature sensor.
- o LED display with illumination and control knobs incorporated in front panel.
- o The display shows: set and current indoor temperature; operation mode for cooling, heating or auto; fan speed.
- o **MLCD E2** model is equipped with a remote control panel.



Control

- o Control by control buttons on regulator casing or by remote control panel (**MLCD E2** model).
 - o Manual or automatic regulation of indoor temperature. Fan speed high/medium/low. On automatic mode fan speed is regulated by indoor temperature.
- Automatic regulation of heating/cooling rate in «Night mode»:
- **Cooling mode:** 30 min after activation of the night mode the set temperature for the room automatically starts rising by 1°C per hour within two hours and stays at this level. After 8 hours the timer turns off and the set temperature resets to initial position.
 - **Heating mode:** 30 min after activation of the night mode the set temperature for the room automatically starts dropping by 1 °C per hour within three hours and stays at this level. After 8 hours the timer turns off and the set temperature resets to initial position.
- o The set control functions are saved when the thermal regulator is switched off.

Wiring diagram

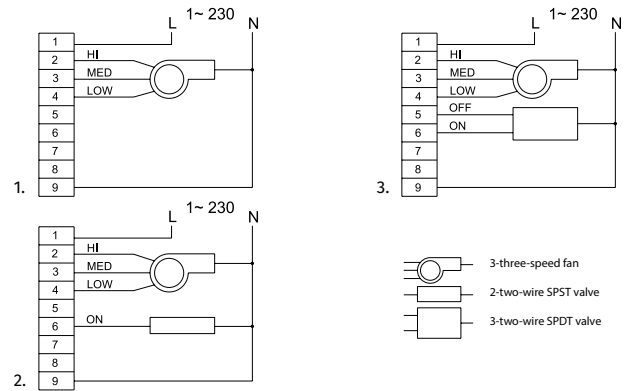

1. Ventilation with heating and cooling
2. Ventilation with heating and cooling three-wire system of SPDT valves
3. Ventilation with heating and cooling two-wire SPDT valve system

Mounting

- o Indoor installation.
- o Recommended installation height is 1.5 m above the floor level.
- o Do not install the regulator close to windows, heating or cooling equipment.

Technical data

Model	MLC E2 / MLCD E2
Voltage [V/Hz]	1~230/50
Rated current [A]	2
Number of speeds	3
Temperature regulating range [°C]	+10...+30
Dimensions W × H × D [mm]	80 × 80 × 63
Max operating temperature [°C]	40
Remote control panel	no/yes



AT-25 220/12

STEP-DOWN TRANSFORMERS

Features

- Low-voltage step-down transformers are used to ensure safe 12 V/50 Hz power supply for residential fans with maximum motor power 16 W (25 VA) and maximum load current 2 A.
- Casing made of high-quality plastic.
- Supplied with external fuse blocks.
- The transformer has overload protection by thermal fuse.



Mounting

- Indoor installation in areas not subjected to high temperature and humidity.
- Suitable for flush mounting behind the false ceiling or wall recess mounting provided that sufficient ventilation is ensured to prevent overheating.
- Do not install the transformer above heating equipment.

Wiring diagram

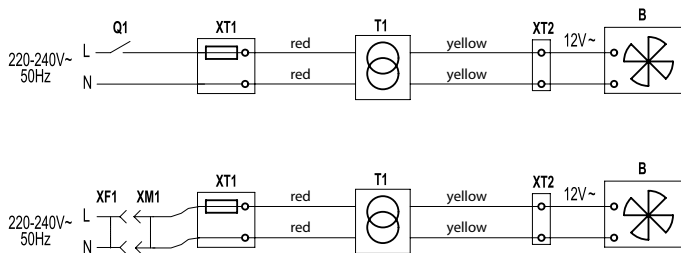

- Q1** – external switch integrated into the fixed wiring system
- XT1** – input fuse block with a built-in thermal fuse in a protecting casing
- XF1** – socket integrated into the fixed wiring system
- XM1** – standard plug
- T1** – transformer
- XT2** – output fuse block for safe 12 V fan connection
- B** – fan with safe 12 V voltage

Technical data

Model	AT-25 220/12
Voltage [V/Hz]	1~230/50
Output voltage [V/Hz]	12/50
Max power [W]	16 (25 VA)
Max current load [A]	2
Dimensions W × H × D [mm]	
Transformer:	91 × 58 × 62
Fuse block:	110 × 40 × 40
Max operating temperature [°C]	40



ATK-25 220/12

STEP-DOWN TRANSFORMERS

Features

- Low-voltage step-down transformers are used to ensure safe 12 V/50 Hz power supply for residential fans with maximum motor power 16 W (25 VA) and maximum load current 2 A.
- Compact casing made of high-quality plastic.
- ATK-25 220/12 S** – the transformer is equipped with a pull-cord switch and a light indicator.
- The transformer has overload protection by thermal fuse.



Mounting

- Indoor installation in areas not subjected to high temperature and humidity.
- Designed for wall surface mounting. Provide free air circulation for cooling of internal circuits.
- Do not install the transformer above the heating equipment.

Technical data

Model	ATK-25 220/12
Voltage [V/Hz]	1~230/50
Output voltage [V/Hz]	12/50
Max power [W]	16 (25 VA)
Max current load [A]	2
Dimensions W × H × D [mm]	80 × 162 × 63
Max operating temperature [°C]	40



Wiring diagram

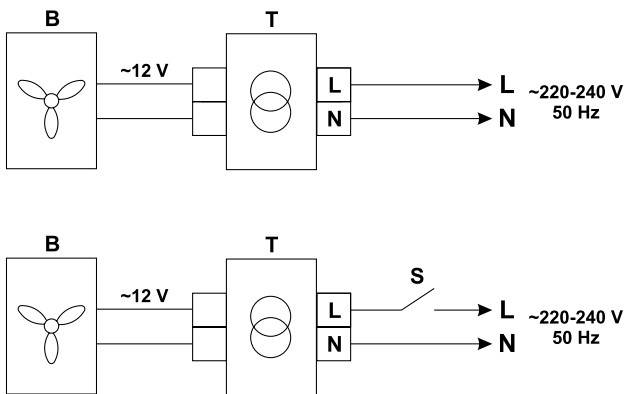

- B** – fan with safe 12 V voltage
- T** – protecting transformer
- S** – external switch

BLAUPLAST

ROUND PLASTIC DUCT SYSTEM

BlauPlast round duct system is the best suitable solution for arranging supply and exhaust ventilation for residential or office premises. The BlauPlast system is used for connection of cooker hoods, kitchen hoods, cowls, etc. to the general ventilation system



Features

- Smooth inner surface ensures low air resistance and low noise level in the system.
- Wide range of available components allows assembling ventilation system of any configuration and complexity.
- Exact compatibility of the components ensures perfect connection and integration into the ventilation system.
- Ergonomic fixing system and modular design shortens required installation and rework time.

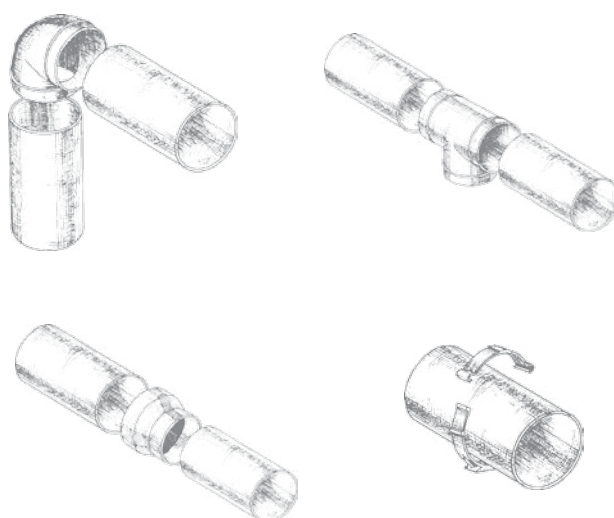
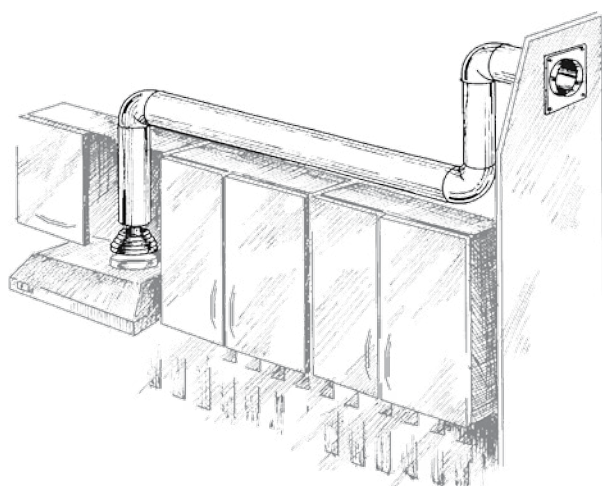

• Round duct RR

- Made of white PVC

Model	Ø d1 (Inner)	Ø d2 (Outer)	l (Length)
BlauPlast RR 100/0.5	100 mm	103 mm	0.5 m
BlauPlast RR 100/1	100 mm	103 mm	1.0 m
BlauPlast RR 100/1.5	100 mm	103 mm	1.5 m
BlauPlast RR 125/0.5	125 mm	128 mm	0.5 m
BlauPlast RR 125/1	125 mm	128 mm	1.0 m
BlauPlast RR 125/1.5	125 mm	128 mm	1.5 m
BlauPlast RR 150/0.5	150 mm	153 mm	0.5 m
BlauPlast RR 150/1	150 mm	153 mm	1.0 m
BlauPlast RR 150/1.5	150 mm	153 mm	1.5 m

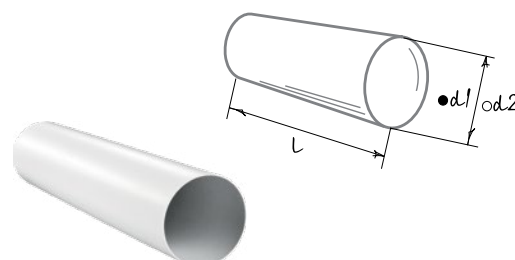

BLAUPLAST

ROUND PLASTIC DUCT SYSTEM

Round telescopic duct RTR

- Made of white PVC
- Extension piece

Model	Inner duct Ø d1 (Inner)	Ø d2 (Outer)	Outer duct Ø d1 (Inner)	Ø d2 (Outer)	l (Length)
BlauPlast RTR 100/0.35-0.5	104 mm	107 mm	100 mm	103 mm	0.35-0.5 m
BlauPlast RTR 100/0.5-1	104 mm	107 mm	100 mm	103 mm	0.5-1 m
BlauPlast RTR 125/0.35-0.5	129 mm	132 mm	125 mm	128 mm	0.35-0.5 m
BlauPlast RTR 125/0.5-1	129 mm	132 mm	125 mm	128 mm	0.5-1 m
BlauPlast RTR 150/0.35-0.5	154 mm	157 mm	150 mm	153 mm	0.35-0.5 m
BlauPlast RTR 150/0.5-1	154 mm	157 mm	150 mm	153 mm	0.5-1 m

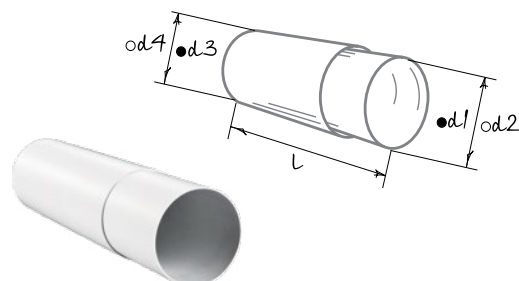

Connector with backdraft damper for round ducts RVK

- Connection of same diameter air ducts
- Made of white plastic
- Equipped with a backdraft damper for back flow prevention
- Designed for direct installation into air duct and equipped with a lock ring

Model	Ø d1	Ø d	a (Length)
BlauPlast RVK 100	96 mm	100 mm	62 mm
BlauPlast RVK 125	123 mm	125 mm	62 mm
BlauPlast RVK 150	148 mm	150 mm	62 mm

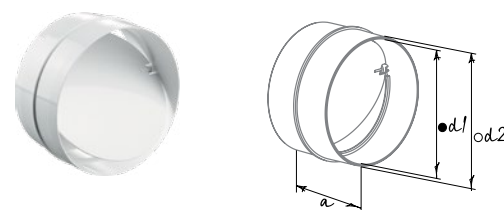

Round duct connector RV

- Direct connection with round air ducts RR
- Made of white plastic

Model	Ø d1 (Inner)	Ø d2 (Outer)	l (Length)
BlauPlast RV 100	96 mm	100 mm	62 mm
BlauPlast RV 125	123 mm	125 mm	62 mm
BlauPlast RV 150	148 mm	150 mm	62 mm

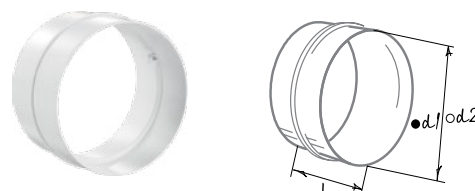

Flexible duct connector RSV

- Mounting with round ducts through connector RV
- Made of white plastic

Model	Ø d1 (Inner)	Ø d2 (Outer)	l (Length)
BlauPlast RSV 100	100 mm	103 mm	60 mm
BlauPlast RSV 125	125 mm	128 mm	60 mm
BlauPlast RSV 150	150 mm	153 mm	60 mm

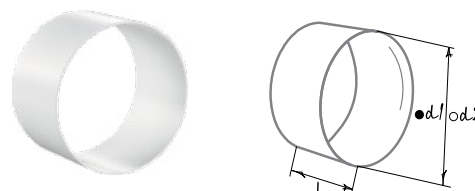

Bend 90° RB

- Direct connection with round ducts RR
- Made of white plastic

Model	Ø d1 (Inner)	Ø d2 (Outer)	h (Height)
BlauPlast RB 100/90°	97 mm	100 mm	137 mm
BlauPlast RB 125/90°	122 mm	125 mm	164 mm
BlauPlast RB 150/90°	147 mm	150 mm	189 mm

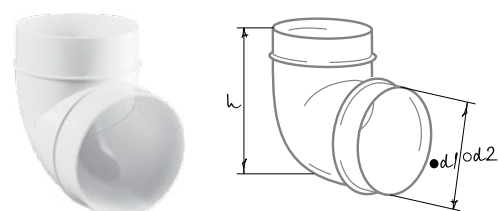

BLAUPLAST

ROUND PLASTIC DUCT SYSTEM

Round duct holder RH

- Air duct mounting to a flat surface
- Made of white plastic
- Fixing to surface with screws

Model	Ø d1 (Inner)	h (Height)
BlauPlast RH 100	103 mm	113 mm
BlauPlast RH 125	128 mm	138 mm
BlauPlast RH 150	153 mm	163 mm

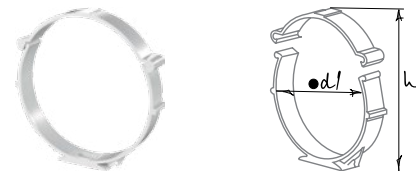

Round duct connector with plate RVP

- Air duct mounting
- Made of white plastic
- Wall or ceiling mounting with screws

Model	Ø d1 (Inner)	Ø d2 (Outer)	a (Overall dimensions)	b (Mounting dimensions)
BlauPlast RVP 100	100 mm	103 mm	150 × 150 mm	134 × 134 mm
BlauPlast RVP 125	125 mm	128 mm	170 × 170 mm	154 × 154 mm
BlauPlast RVP 150	150 mm	153 mm	204 × 204 mm	188 × 188 mm

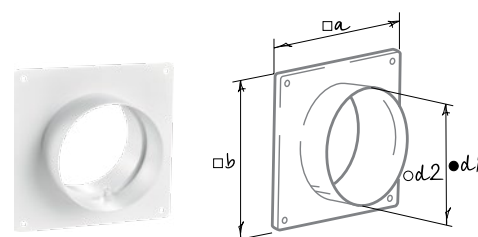

Round duct connector with a plate and a gravity backdraft damper RVPK

- Air duct mounting
- Made of white plastic
- Wall or ceiling mounting with screws
- Damper prevents air back drafting

Model	Ø d1 (Inner)	Ø d2 (Outer)	a (Overall dimensions)	b (Mounting dimensions)
BlauPlast RVPK 100	100 mm	103 mm	150 × 150 mm	134 × 134 mm
BlauPlast RVPK 125	125 mm	128 mm	170 × 170 mm	154 × 154 mm
BlauPlast RVPK 150	150 mm	153 mm	204 × 204 mm	188 × 188 mm

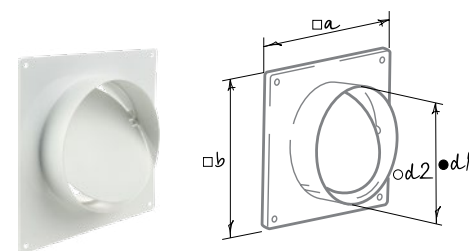

Wall plate for round ducts WP

- Connection of air ducts to ventilation shafts
- Decoration of mounting openings
- Made of white plastic
- Screw fixing to wall

Model	Ø d	a	b
BlauPlast WP 100	103 mm	150 mm	134 mm
BlauPlast WP 125	128 mm	170 mm	154 mm
BlauPlast WP 150	151 mm	204 mm	188 mm

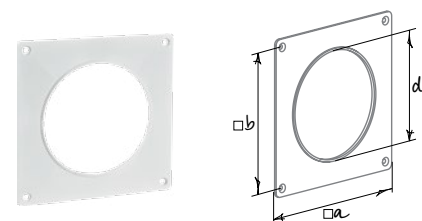

Round duct reducer RS

- For connection of various diameter round air ducts RR
- Made of white plastic

Model	Ø D2 (Inner)	Ø D1 (Outer)	Ø D3 (Inner)	Ø D4 (Outer)	a (Width)
BlauPlast RS 80/100	100 mm	103 mm	76 mm	80 mm	60 mm
BlauPlast RS 100/125	125 mm	129 mm	96 mm	100 mm	60 mm
BlauPlast RS 125/150	150 mm	154 mm	121 mm	125 mm	60 mm

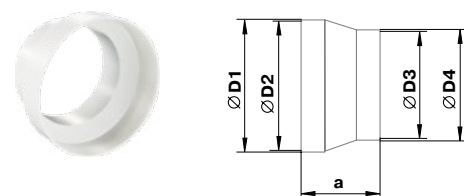

BLAUPLAST

ROUND PLASTIC DUCT SYSTEM

o Reducer RS

- Connection of \varnothing 120 and 125 mm round air ducts
- Made of white plastic

Model	\varnothing D1	\varnothing D2	\varnothing D3	\varnothing D4	a
BlauPlast RS 120/130	129 mm	125 mm	115 mm	119 mm	42 mm

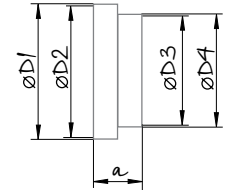

o Round step reducer RS

- For connection of various diameter round air ducts RR
- Made of white plastic

Model	\varnothing d1 [mm]		\varnothing d2 [mm]		\varnothing d3 [mm]		\varnothing d4 [mm]		\varnothing d5 [mm]		l (Width)
	Inner	Outer	Inner	Outer	Inner	Outer	Inner	Outer	Inner	Outer	
BlauPlast RS 80-150	75	80	95	100	115	120	120	125	145	150	125

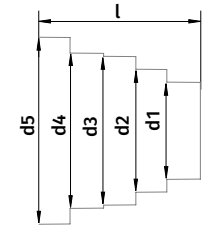

o Eccentric reducer RSE

- Connection of round ducts
- Made of white plastic

Model	\varnothing D1	\varnothing D2	\varnothing D3	\varnothing D4	\varnothing D5	\varnothing D6	a
BlauPlast RSE 100/125	125 mm	120 mm	123 mm	103 mm	99 mm	-	90 mm
BlauPlast RSE 125/150	151 mm	148 mm	152 mm	132 mm	129 mm	125 mm	96 mm

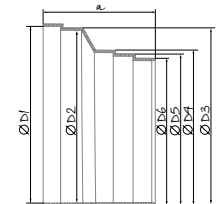

o T-joint for round ducts RRT

- Connection of same diameter round ducts and integration into complex ventilation systems
- Made of white plastic
- Connection of same diameter three round ducts at 90°

Model	\varnothing d2 (Inner)	\varnothing d1 (Outer)	a	b
BlauPlast RRT 100	97 mm	100 mm	173 mm	30 mm
BlauPlast RRT 125	122 mm	125 mm	198 mm	30 mm
BlauPlast RRT 150	147 mm	150 mm	223 mm	30 mm

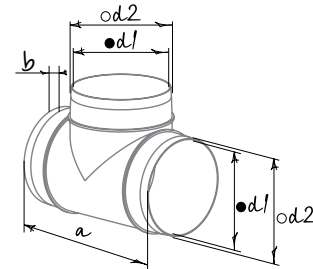

o Round flexible duct connector RVF

- Connection of flexible ducts with plastic system components
- Made of white plastic
- Connection to flexible air ducts without clamps
- **BlauPlast RVF(R) 100:** Flexible spiral seam duct is connected to one side and the other side is connected to \varnothing 100 mm flange
- **BlauPlast RVFI(R) 100:** Flexible spiral seam duct is connected to one side and the other side is connected to \varnothing 100 mm air duct
- Left or right (R) thread Right thread connectors are used with BlauFlex air ducts

Model	\varnothing A	B	C	\varnothing D	\varnothing E
BlauPlast RVF 100	90 mm	30 mm	60 mm	100 mm	110 mm
BlauPlast RVF-R 100	90 mm	30 mm	60 mm	100 mm	110 mm
BlauPlast RVFI 100	90 mm	30 mm	60 mm	100 mm	110 mm
BlauPlast RVFI-R 100	90 mm	30 mm	60 mm	100 mm	110 mm

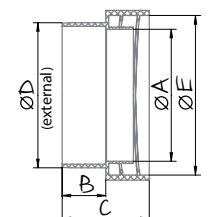
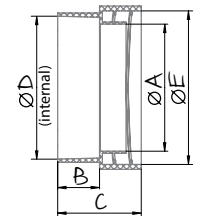

BLAUPLAST

FLAT PLASTIC DUCT SYSTEM

BlauPlast flat plastic duct system is the best suitable solution for arranging supply and exhaust ventilation for residential or office premises. The BlauPlast system is used for connection of cooker hoods, kitchen hoods, cowls, etc. to the general ventilation system

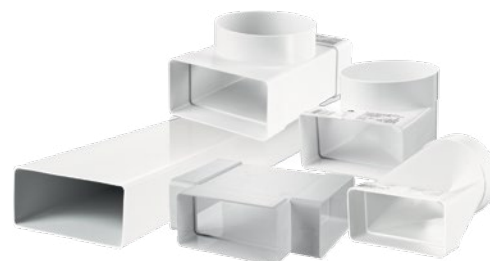

Features

- Smooth inner surface ensures low air resistance and low noise level in the system.
- Wide range of available components allows assembling ventilation of any configuration and complexity.
- Exact matching of the components ensures perfect connection and integration into the ventilation system.
- Ergonomic fixing system and modular design shortens required installation and rework time.
- Versatile connectors and reducers provide combination of flat and round ventilation ductworks.
- Compact sizes make the system suitable for installation in brand new or newly refurbished premises.

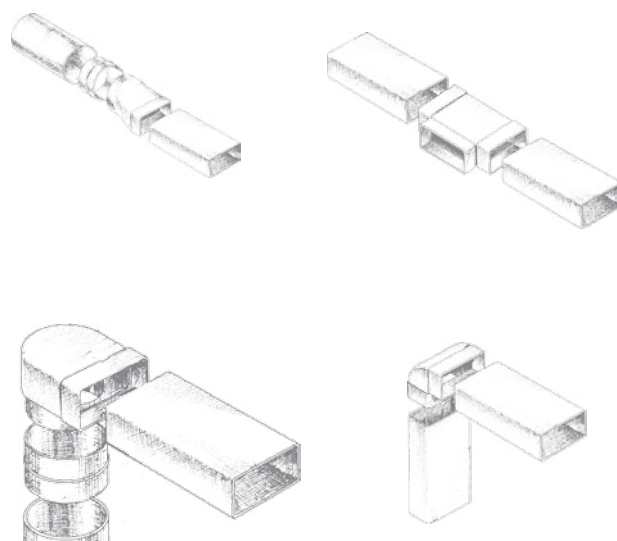
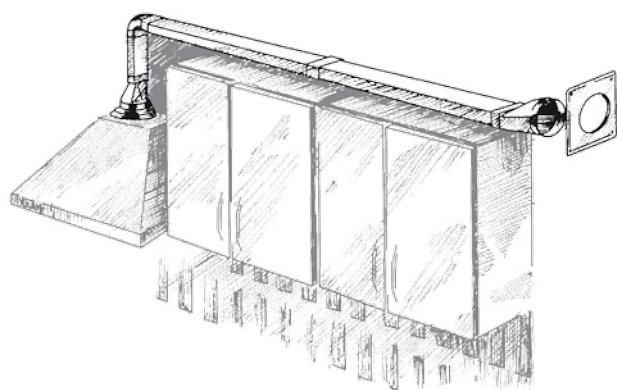

FK flat air duct

- Made of white PVC

Model	a × b (Inner size)	c × d (Outer size)	l (Length)
BlauPlast FK 110x55/0.5	52 × 107 mm	55 × 110 mm	0.5 m
BlauPlast FK 110x55/1	52 × 107 mm	55 × 110 mm	1.0 m
BlauPlast FK 110x55/1.5	52 × 107 mm	55 × 110 mm	1.5 m
BlauPlast FK 204x60/0.5	57 × 200 mm	60 × 204 mm	0.5 m
BlauPlast FK 204x60/1	57 × 200 mm	60 × 204 mm	1.0 m
BlauPlast FK 204x60/1.5	57 × 200 mm	60 × 204 mm	1.5 m

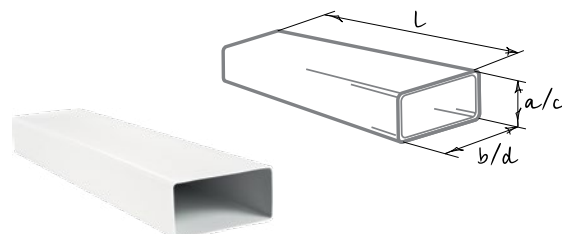

FKV flat air duct connector

- Direct connection with the FK flat air ducts
- Made of white plastic

Model	a × b (Inner size)	c × d (Outer size)	l (Length)
BlauPlast FKV 110x55	55 × 110 mm	59 × 114 mm	62 mm
BlauPlast FKV 204x60	60 × 204 mm	64 × 208 mm	62 mm

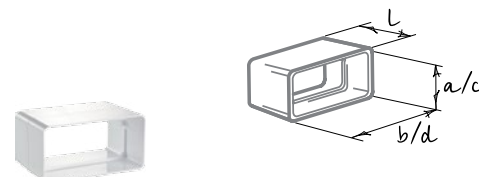

BLAUPLAST

FLAT PLASTIC DUCT SYSTEM

o Bend US-90°

- Direct connection with the flat **FK** air duct, connection with the round **RR** air duct through the **RV** connector
- Made of white plastic

Model	Round flange		Flat flange a × b (Inner size)	c × d (Outer size)	l (Length)	h (Height)
	Ø d1 (Inner)	Ø d2 (Outer)				
BlauPlast US-90° 100/110x55	100 mm	103 mm	55 × 110 mm	58 × 113 mm	138 mm	87 mm
BlauPlast US-90° 100/204x60	100 mm	103 mm	60 × 204 mm	64 × 208 mm	164 mm	92 mm
BlauPlast US-90° 125/204x60	122 mm	125 mm	60 × 204 mm	64 × 208 mm	220 mm	92 mm

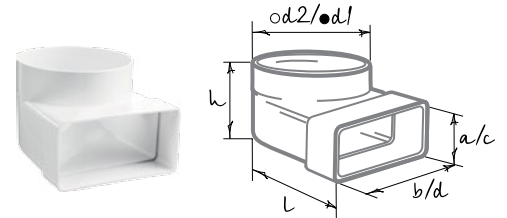

o Versatile flat angular connector FKVU

- Angular connection of flat ducts **FK**
- Made of white plastic
- Turning point angle from 3° to 48°
- Depending on selected turning angle one connector side is cut out Connection to the flat duct through matching sized connector
- On flange side direct connection to flat duct of respective size

Model	a	b	c
BlauPlast FKVU 110x55	190 mm	143 mm	55 × 110 mm
BlauPlast FKVU 204x60	286 mm	247 mm	60 × 204 mm

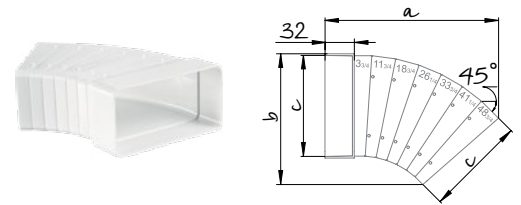

o Vertical connecting bend FKW

- Direct vertical connection with the **FK** flat duct
- Made of white plastic

Model	a × b (Inner size)	c × d (Outer size)	h (Height)
BlauPlast FKW 110x55	55 × 110 mm	58 × 113 mm	89 mm
BlauPlast FKW 204x60	60 × 204 mm	64 × 208 mm	103 mm

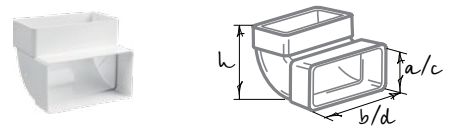

o Horizontal connecting bend FKB

- Horizontal connection with the **FK** flat duct
- Made of white plastic

Model	a × b (Inner size)	h (Height)
BlauPlast FKB 110x55	55 mm × 110 mm	143 mm
BlauPlast FKB 204x60	60 mm × 204 mm	237 mm

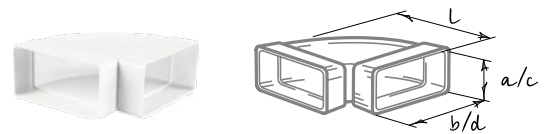

o Connector UBS

- Direct connection with the flat **FK** air duct, connection with the round **RR** air duct through the **RV** connector
- Made of white plastic

Model	Round flange		Flat flange a × b (Inner size)	l (Length)
	Ø d1 (Inner)	Ø d2 (Outer)		
BlauPlast UBS 100/110x55	100 mm	103 mm	55 × 110 mm	137 mm
BlauPlast UBS 125/204x60	125 mm	128 mm	60 × 204 mm	140 mm

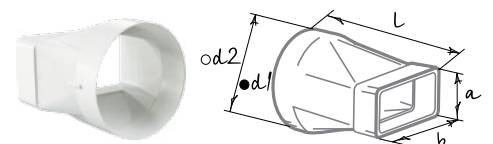

o Flat duct T-connector FKT

- Direct horizontal connection with the **FK** flat duct
- Made of white plastic

Model	a × b (Inner size)	c × d (Overall dimensions)
BlauPlast FKT 110x55	55 × 110 mm	144 × 174 mm
BlauPlast FKT 204x60	60 × 204 mm	248 × 288 mm

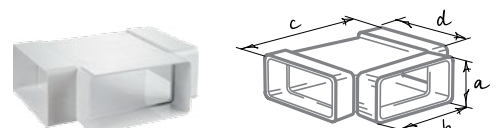

BLAUPLAST

FLAT PLASTIC DUCT SYSTEM

Flat to round connector FRT

- Direct connection with the flat **FK** air duct, connection with the round **RR** air duct through the **RV** connector
- Made of white plastic

Model	Round flange		Flat flange	l (Length)
	Ø d1 (Inner)	Ø d2 (Outer)	a × b (Inner size)	
BlauPlast FRT 100/110x55	100 mm	103 mm	55 × 110 mm	172 mm

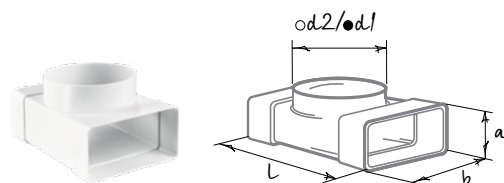

Flat duct holder FKH

- Mounting of the **FK** flat air duct to a surface
- Made of white plastic
- Fixing with screws

Model	a × b (Overall dimensions)	c	L
BlauPlast FKH 110x55	59 × 114 mm	74 mm	32 mm
BlauPlast FKH 204x60	65 × 209 mm	169 mm	40 mm

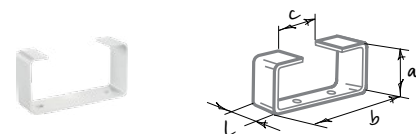

Flat duct connector with damper FKVK

- Connection of same sized flat ducts **FK**
- Made of white plastic
- Designed for installation into air duct and equipped with a lock ring for easy jointing
- Equipped with a backdraft damper for back flow prevention

Model	a	b	a1	b1	c
BlauPlast FKVK 110x55	55 mm	110 mm	59 mm	114 mm	66 mm
BlauPlast FKVK 204x60	60 mm	204 mm	64 mm	208 mm	91 mm

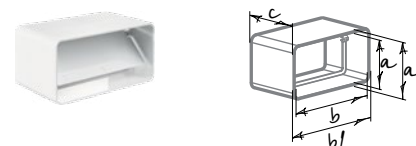

Flat duct connector FKSV

- Connection of same sized flat ducts **FK**
- Made of white plastic
- Designed for installation into air duct and equipped with a lock ring for easy jointing

Model	a	b	a1	b1	c
BlauPlast FKSV 110x55	55 mm	110 mm	52 mm	107 mm	60 mm
BlauPlast FKSV 204x60	60 mm	204 mm	57 mm	200 mm	60 mm

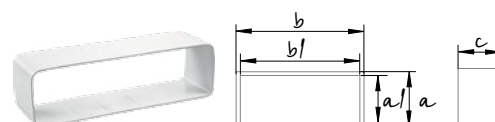

Air duct connector with a plate FVP

- Connection of single size flat air ducts **FK**
- Decoration of mounting opening and connections to wall
- Made of white plastic
- Air ducts are fitted inside the connector
- Equipped with lock rings for easy adjustment
- Screw fixing to wall

Model	a	b	c	A	B	C	D	L
BlauPlast FVP 110x55	110 mm	55 mm	2 mm	141 mm	154 mm	154 mm	141 mm	645 mm
BlauPlast FVP 204x60	204 mm	60 mm	3 mm	229 mm	154 mm	242 mm	141 mm	915 mm

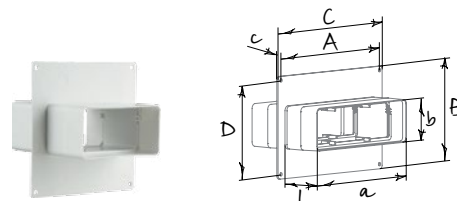

Air duct connector with a plate and a back valve FVPK

- Connection of single size flat air ducts **FK**
- Decoration of mounting opening and connections to wall
- Made of white plastic
- Air ducts are fitted inside the connector
- Equipped with lock rings for easy adjustment
- Equipped with a back valve to prevent back drafting
- Screw fixing to wall

Model	a	b	c	A	B	C	D	L
BlauPlast FVPK 110x55	110 mm	55 mm	2 mm	141 mm	154 mm	154 mm	141 mm	131 mm
BlauPlast FVPK 204x60	204 mm	60 mm	3 mm	229 mm	154 mm	242 mm	141 mm	186 mm

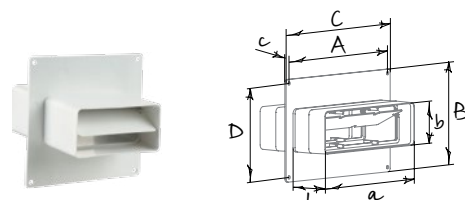

BLAUPLAST

FLAT PLASTIC DUCT SYSTEM

o Wall plate for flat ducts WP

- Connection of air ducts to ventilation shafts
- Decoration of mounting openings
- Made of white plastic
- Screw fixing to wall

Model	a	b	c	d	e	D	E
BlauPlast WP 110x55	111 mm	56 mm	2 mm	141 mm	141 mm	154 mm	154 mm
BlauPlast WP 204x60	204 mm	60 mm	3 mm	229 mm	154 mm	242 mm	141 mm

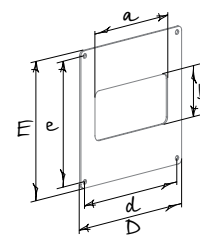

o Reducer for flat ducts FS

- Connection of flat different sized ducts
- Made of white plastic

Model	a	b	c
BlauPlast FS 110x54/204x60	60 × 204 mm	55 × 110 mm	30 mm

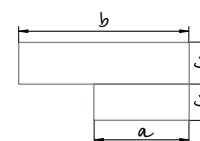

o End grille DECOR

- Correct air flow distribution in premises
- Wall or ceiling mounting
- Made of white plastic
- Detachable front part facilitates cleaning
- Modification with an insect screen (s) is available

Model	a	b	c	d	e
DECOR 81x136	88 mm	137 mm	114 mm	59 mm	73 mm
DECOR 86x230	93 mm	232 mm	208 mm	64 mm	76 mm

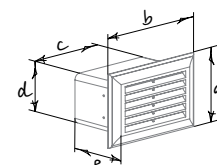

o End grille with air pass regulation DECOR

- Correct air flow distribution in premises
- Wall or ceiling mounting
- Made of white plastic
- Equipped with a movable flap for air flow regulation
- Air pass is regulated with a tilt wand
- Detachable front part facilitates cleaning
- Modification with an insect screen (s) is available

Model	a	b	c	d	e	f
DECOR 81x136 R	88 mm	137 mm	114 mm	59 mm	73 mm	18 mm
DECOR 86x230 R	93 mm	232 mm	208 mm	64 mm	76 mm	18 mm

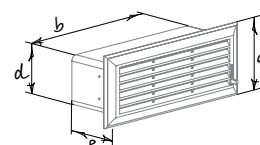

o Reducer for flat and round ducts US/USV

- Flat to round duct connection
- Made of white plastic
- **BlauPlast US 100/110x55:** direct connection of reducer to round and flat ducts
- **BlauPlast USV 100/110x55:** reducer has direct connection to flat air ducts and connection through connector to round ducts

Model	c × b	∅ D	f	a
BlauPlast US 100/110x55	58 × 114 mm	103 mm	62 mm	32 mm
BlauPlast USV 100/110x55	58 × 114 mm	100 mm	62 mm	32 mm

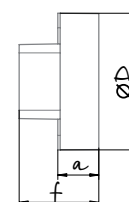
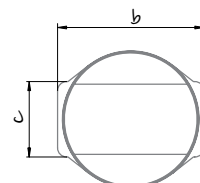

BLAUPLAST RRF/FKF

ROUND AND FLAT FOLDING PVC DUCT SYSTEM

The BlauPlast foldable plastic air ducts offer innovative and practical ventilation solutions. The foldable ducts enable efficient logistics and space saving during storage or exhibiting.

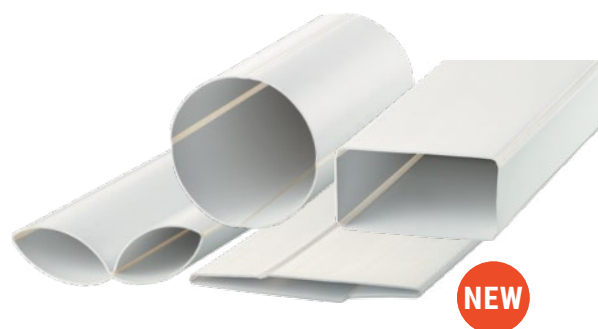

Features

- 40 % higher transportation efficiency - more units per dispatch 60 % less warehouse storage space required.
- Improved showroom stock diversity - even at small shops 20 % less time required for duct processing and fastening.
- Easy and efficient mounting, better fit of parts made of elastic polymer material.
- Compatible with the standard connectors and fixtures of BlauPlast air duct system.



Design and overall dimensions

BLAUPLAST RRF

- White PVC.
- Diameter 100 mm.
- Duct length ranges from 350 to 2500 mm.
- Joined by means of appropriate diameter connectors.

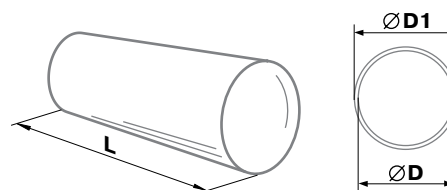

Dimensions [mm]	D	D1	L
BlauPlast RRF 100/0.35	100	103	350
BlauPlast RRF 100/0.5	100	103	500
BlauPlast RRF 100/1	100	103	1000
BlauPlast RRF 100/1.5	100	103	1500
BlauPlast RRF 100/2	100	103	2000
BlauPlast RRF 100/2.5	100	103	2500

BLAUPLAST FKF

- White PVC.
- Cross-section of 55 × 110 mm.
- Duct length ranges from 350 to 2500 mm.
- Joined by means of appropriate section connectors.

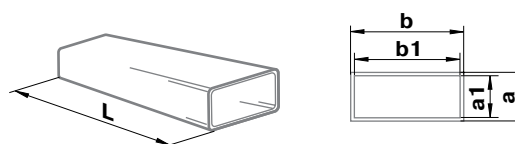

Dimensions [mm]	a	b	a1	b1	L
BlauPlast FKF 110x55/0.35	55	110	52	107	350
BlauPlast FKF 110x55/0.5	55	110	52	107	500
BlauPlast FKF 110x55/1	55	110	52	107	1000
BlauPlast FKF 110x55/1.5	55	110	52	107	1500
BlauPlast FKF 110x55/2	55	110	52	107	2000
BlauPlast FKF 110x55/2.5	55	110	52	107	2500

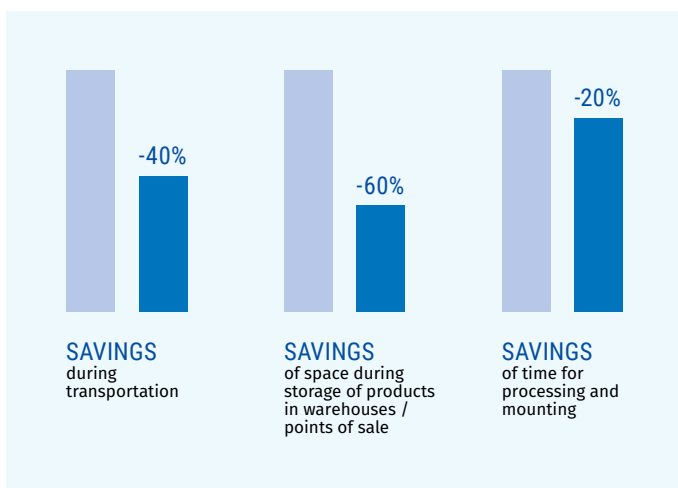

BLAUFLEX ISO N

FLEXIBLE AIR DUCTS

BlauFlex Iso N flexible insulated air ducts are intended for domestic and industrial HVAC systems requiring heat insulation and air duct flexibility to prevent condensate build-up and minimise heat losses.



o BlauFlex Iso N flexible air duct

- Made from 40 micron metallised polyether film.
- The spiral armature is made of 0.8 - 1.5 mm thick high-carbon steel wire.
- The insulation is provided by a 25 mm layer of pollutant-free mineral wool.
- Maximum air flow speed is 30 m/s.
- Maximum working pressure is 3,000 Pa.
- Improved elasticity and thermal stability in the -30...+120 °C range (with short-term exposure to +120 °C).
- Does not release any noxious substances under normal operation.

Model	Ø d	l (Length)	Base layer thickness, microns	Mineral wool thickness
BlauFlex Iso N 82/7.6	82 mm	7.6 m	40	25 mm
BlauFlex Iso N 102/7.6	102 mm	7.6 m	40	25 mm
BlauFlex Iso N 127/7.6	127 mm	7.6 m	40	25 mm
BlauFlex Iso N 152/7.6	152 mm	7.6 m	40	25 mm
BlauFlex Iso N 162/7.6	162 mm	7.6 m	40	25 mm
BlauFlex Iso N 182/7.6	182 mm	7.6 m	40	25 mm
BlauFlex Iso N 203/7.6	203 mm	7.6 m	40	25 mm
BlauFlex Iso N 254/7.6	254 mm	7.6 m	40	25 mm
BlauFlex Iso N 315/7.6	315 mm	7.6 m	40	25 mm

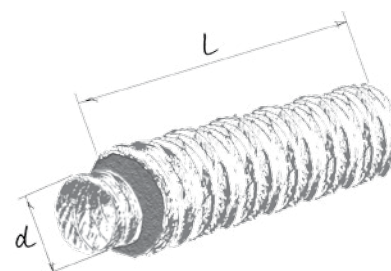

BLAUFLEX

FLEXIBLE AIR DUCTS

The **BlauFlex** foldable air ducts are recommended for use in residential and industrial application and ventilation, heating and air conditioning systems.



Mounting

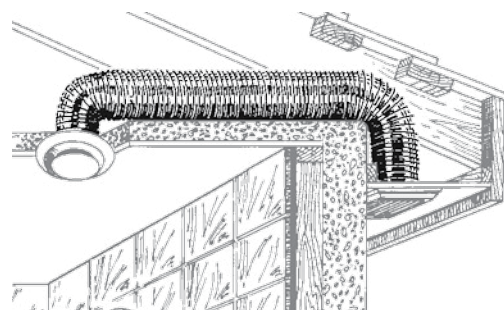
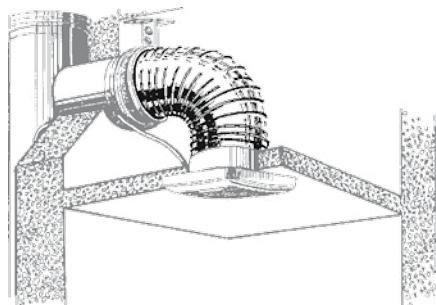

Flexible air duct **BlauFlex AM / BlauFlex AN**

- Made of 80 micron thick aluminium band for BlauFlex AN and 50 micron for BlauFlex AM
- Temperature range, °C: -30 ... +250

Model	Ø d	l (Length)	Thickness, microns
BlauFlex AN 80/3	80 mm	3 m	80
BlauFlex AN 100/3	100 mm	3 m	80
BlauFlex AN 110/3	110 mm	3 m	80
BlauFlex AN 115/3	115 mm	3 m	80
BlauFlex AN 120/3	120 mm	3 m	80
BlauFlex AN 125/3	125 mm	3 m	80
BlauFlex AN 130/3	130 mm	3 m	80
BlauFlex AN 135/3	135 mm	3 m	80
BlauFlex AN 140/3	140 mm	3 m	80
BlauFlex AN 150/3	150 mm	3 m	80
BlauFlex AN 160/3	160 mm	3 m	80
BlauFlex AN 200/3	200 mm	3 m	80
BlauFlex AN 250/3	250 mm	3 m	80
BlauFlex AN 315/3	315 mm	3 m	80
BlauFlex AM 80/3	80 mm	3 m	50
BlauFlex AM 100/3	100 mm	3 m	50
BlauFlex AM 110/3	110 mm	3 m	50
BlauFlex AM 115/3	115 mm	3 m	50
BlauFlex AM 120/3	120 mm	3 m	50
BlauFlex AM 125/3	125 mm	3 m	50
BlauFlex AM 130/3	130 mm	3 m	50
BlauFlex AM 135/3	135 mm	3 m	50
BlauFlex AM 140/3	140 mm	3 m	50
BlauFlex AM 150/3	150 mm	3 m	50
BlauFlex AM 160/3	160 mm	3 m	50
BlauFlex AM 200/3	200 mm	3 m	50
BlauFlex AM 250/3	250 mm	3 m	50
BlauFlex AM 315/3	315 mm	3 m	50

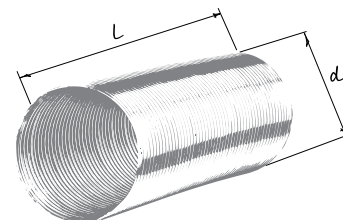

BLAUFLEX

FLEXIBLE AIR DUCTS

o Flexible air duct BlauFlex AF

- Made of polyester laminated aluminium foil reinforced with spiral steel wire
- Temperature range, °C : -30 ... +250 (for BlauFlex AF M0), -30 ... +150 (BlauFlex AF M1)

Model	Ø d	l (Length)
BlauFlex AF M0/102/1	102 mm	1 m
BlauFlex AF M0/102/3	102 mm	3 m
BlauFlex AF M0/102/6	102 mm	6 m
BlauFlex AF M0/102/10	102 mm	10 m
BlauFlex AF M0/127/1	127 mm	1 m
BlauFlex AF M0/127/3	127 mm	3 m
BlauFlex AF M0/127/6	127 mm	6 m
BlauFlex AF M0/127/10	127 mm	10 m
BlauFlex AF M0/152/1	152 mm	1 m
BlauFlex AF M0/152/3	152 mm	3 m
BlauFlex AF M0/152/6	152 mm	6 m
BlauFlex AF M0/152/10	152 mm	10 m
BlauFlex AF M1/102/1	102 mm	1 m
BlauFlex AF M1/102/3	102 mm	3 m
BlauFlex AF M1/102/6	102 mm	6 m
BlauFlex AF M1/102/10	102 mm	10 m
BlauFlex AF M1/127/1	127 mm	1 m
BlauFlex AF M1/127/3	127 mm	3 m
BlauFlex AF M1/127/6	127 mm	6 m
BlauFlex AF M1/127/10	127 mm	10 m
BlauFlex AF M1/152/1	152 mm	1 m
BlauFlex AF M1/152/3	152 mm	3 m
BlauFlex AF M1/152/6	152 mm	6 m
BlauFlex AF M1/152/10	152 mm	10 m

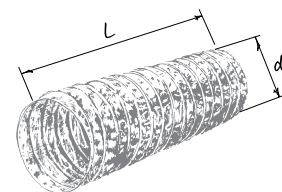

o Flexible air duct BlauFlex PVC

- Made of 65 micron thick white PVC film reinforced with steel wire frame
- Temperature range, °C : -18 ... +70

Model	Ø d	l (Length)
BlauFlex PVC/82/1	82 mm	1 m
BlauFlex PVC/82/3	82 mm	3 m
BlauFlex PVC/82/6	82 mm	6 m
BlauFlex PVC/82/10	82 mm	10 m
BlauFlex PVC/102/1	102 mm	1 m
BlauFlex PVC/102/3	102 mm	3 m
BlauFlex PVC/102/6	102 mm	6 m
BlauFlex PVC/102/10	102 mm	10 m
BlauFlex PVC/127/1	127 mm	1 m
BlauFlex PVC/127/3	127 mm	3 m
BlauFlex PVC/127/6	127 mm	6 m
BlauFlex PVC/127/10	127 mm	10 m
BlauFlex PVC/152/1	152 mm	1 m
BlauFlex PVC/152/3	152 mm	3 m
BlauFlex PVC/152/6	152 mm	6 m
BlauFlex PVC/152/10	152 mm	10 m

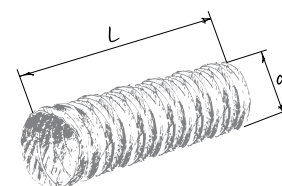

FITTINGS FOR ROUND AIR DUCTS

The mounting fittings are used for fixation and connection of round air ducts.



o **Clamp for round flexible ducts K**

- Made of stainless steel (K) or galvanized steel (K ... Zn)
- Mounting of flexible air ducts

Model	Ø D	H (Band width)
K 100 (Zn)	90-110 mm	9 mm
K 125 (Zn)	110-130 mm	9 mm
K 150 (Zn)	140-160 mm	9 mm
K 160 (Zn)	150-170 mm	9 mm
K 200 (Zn)	190-210 mm	9 mm

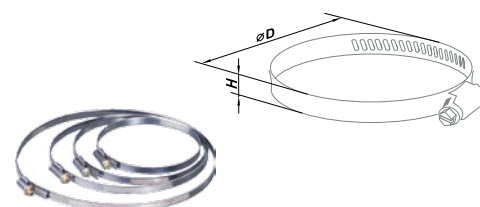

o **Clamp for round ducts KZ**

- Made of galvanized steel with microporous rubber for vibration damping
- Mounting of round air ducts
- Wall or ceiling mounting

Model	Ø D	H (Height)
KZ 80	80 mm	152 mm
KZ 100	100 mm	172 mm
KZ 125	125 mm	198 mm
KZ 150	150 mm	224 mm
KZ 160	160 mm	232 mm
KZ 200	200 mm	274 mm
KZ 250	250 mm	326 mm
KZ 315	315 mm	380 mm
KZH 80	80 mm	94 mm
KZH 100	100 mm	204 mm
KZH 125	125 mm	229 mm
KZH 150	150 mm	254 mm
KZH 160	160 mm	264 mm
KZH 200	200 mm	304 mm
KZH 250	250 mm	354 mm
KZH 315	315 mm	419 mm

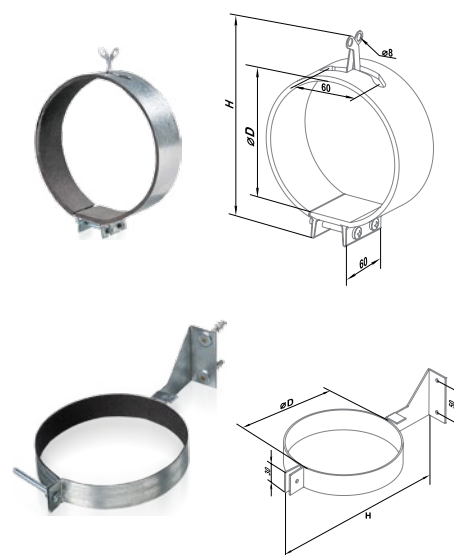

o **Flange for round ducts AP**

- Made of white plastic
- Connection of round flexible air ducts
- Wall or ceiling mounting with screws
- Equipped with a lock ring for fixation of flexible air ducts

Model	Ø D	Ø D1	Ø D2	L (Length)
AP 80	80 mm	115 mm	120 mm	62 mm
AP 100	100 mm	132 mm	139 mm	62 mm
AP 125	125 mm	157 mm	165 mm	62 mm
AP 150	150 mm	179 mm	188 mm	62 mm
AP 200	200 mm	232 mm	240 mm	62 mm

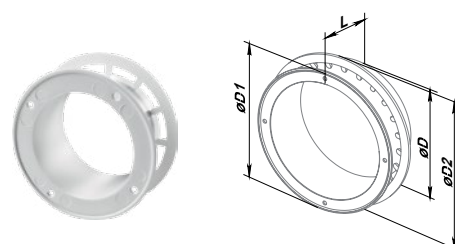

o Flange for round ducts FR

- Made of white polymer coated steel (FRM) or galvanized steel (FRZ)
- Connection of round flexible air ducts
- Wall or ceiling mounting with screws

Model	Ø D	Ø D1	L (Length)
FRM 80	80 mm	116 mm	62 mm
FRM 100	100 mm	136 mm	62 mm
FRM 125	125 mm	162 mm	62 mm
FRM 150	150 mm	186 mm	62 mm
FRM 160	160 mm	196 mm	62 mm
FRM 200	200 mm	236 mm	62 mm
FRM 250	250 mm	286 mm	62 mm
FRM 315	315 mm	351 mm	62 mm
FRZ 80	80 mm	116 mm	62 mm
FRZ 100	100 mm	136 mm	62 mm
FRZ 125	125 mm	162 mm	62 mm
FRZ 150	150 mm	186 mm	62 mm
FRZ 160	160 mm	196 mm	62 mm
FRZ 200	200 mm	236 mm	62 mm
FRZ 250	250 mm	286 mm	62 mm
FRZ 315	315 mm	351 mm	62 mm

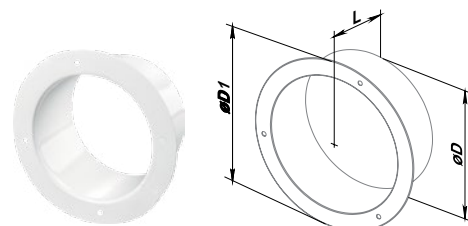

o Round duct reducer RS

- Made of white polymer coated steel (RSM) or galvanized steel (RSZ)
- For connection of round air ducts

Model	Ø D	Ø D1	L (Length)
RSM 80/100	80 mm	100 mm	115 mm
RSM 100/125	100 mm	125 mm	125 mm
RSM 100/150	100 mm	150 mm	125 mm
RSM 125/150	125 mm	150 mm	125 mm
RSM 125/160	125 mm	160 mm	144 mm
RSM 150/160	150 mm	160 mm	172 mm
RSM 160/200	160 mm	200 mm	154 mm
RSM 150/200	150 mm	200 mm	172 mm
RSM 200/250	200 mm	250 mm	172 mm
RSM 250/315	250 mm	315 mm	195 mm
RSZ 80/100	80 mm	100 mm	115 mm
RSZ 100/125	100 mm	125 mm	125 mm
RSZ 100/150	100 mm	150 mm	125 mm
RSZ 125/150	125 mm	150 mm	125 mm
RSZ 125/160	125 mm	160 mm	144 mm
RSZ 150/160	150 mm	160 mm	172 mm
RSZ 160/200	160 mm	200 mm	154 mm
RSZ 150/200	150 mm	200 mm	172 mm
RSZ 200/250	200 mm	250 mm	172 mm
RSZ 250/315	250 mm	315 mm	195 mm

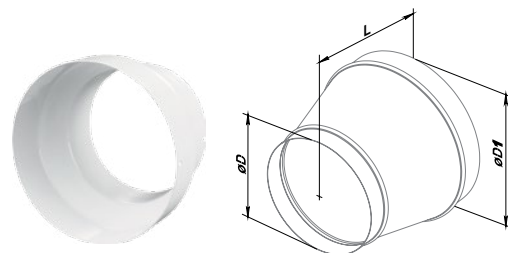

FITTINGS FOR ROUND AIR DUCTS

o Cross joint for round duct KS

- Made of white polymer coated steel (**KSM**) or galvanized steel (**KSZ**)
- Connection of round air ducts

Model	Ø D1	Ø D2	B (Length)
KSM 80	80 mm	80 mm	170 mm
KSM 100	100 mm	100 mm	190 mm
KSM 125	125 mm	125 mm	215 mm
KSM 150	150 mm	150 mm	240 mm
KSM 160	160 mm	160 mm	250 mm
KSM 200	200 mm	200 mm	300 mm
KSM 250	250 mm	250 mm	350 mm
KSM 315	315 mm	315 mm	415 mm
KSZ 80	80 mm	80 mm	170 mm
KSZ 100	100 mm	100 mm	190 mm
KSZ 125	125 mm	125 mm	215 mm
KSZ 150	150 mm	150 mm	240 mm
KSZ 160	160 mm	160 mm	250 mm
KSZ 200	200 mm	200 mm	300 mm
KSZ 250	250 mm	250 mm	350 mm
KSZ 315	315 mm	315 mm	415 mm

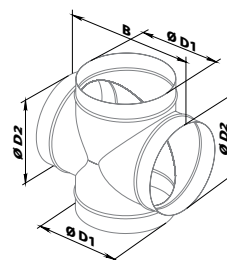
o T-connector for round air ducts TS-90°

- Made of white polymer coated steel (**TSM**) or galvanized steel (**TSZ**)
- Connection of round air ducts

Model	Ø D1	Ø D2	B (Length)
TSM-90° 80	80 mm	80 mm	170 mm
TSM-90° 100	100 mm	100 mm	190 mm
TSM-90° 125	125 mm	125 mm	215 mm
TSM-90° 150	150 mm	150 mm	240 mm
TSM-90° 160	160 mm	160 mm	250 mm
TSM-90° 200	200 mm	200 mm	300 mm
TSM-90° 250	250 mm	250 mm	350 mm
TSM-90° 315	315 mm	315 mm	415 mm
TSZ-90° 80	80 mm	80 mm	170 mm
TSZ-90° 100	100 mm	100 mm	190 mm
TSZ-90° 125	125 mm	125 mm	215 mm
TSZ-90° 150	150 mm	150 mm	240 mm
TSZ-90° 160	160 mm	160 mm	250 mm
TSZ-90° 200	200 mm	200 mm	300 mm
TSZ-90° 250	250 mm	250 mm	350 mm
TSZ-90° 315	315 mm	315 mm	415 mm

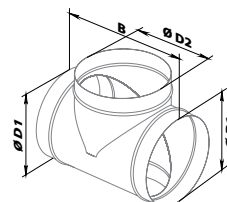
o Backdraft damper for round ducts VRV

- Galvanized steel body and aluminium blades
- For prevention of back drafting in round air ducts
- Damper blades are opened by pressure and closed with a spring
- Connection to round air ducts by clamps

Model	Ø D	L (Length)
VRV 100	99 mm	80 mm
VRV 125	124 mm	100 mm
VRV 150	149 mm	115 mm
VRV 160	159 mm	120 mm
VRV 200	199 mm	145 mm
VRV 250	249 mm	165 mm
VRV 315	314 mm	190 mm

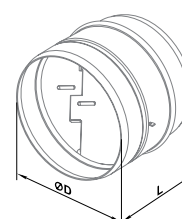

o **Round duct connector SV**

- Made of white polymer coated steel (**SVM**) or galvanized steel (**SVZ**)
- Connection of round air ducts

Model	Ø D	L (Length)
SVM 80	80 mm	62 mm
SVM 100	100 mm	62 mm
SVM 125	125 mm	62 mm
SVM 150	150 mm	62 mm
SVM 160	160 mm	62 mm
SVM 200	200 mm	62 mm
SVM 250	250 mm	62 mm
SVM 315	315 mm	62 mm
SVZ 80	80 mm	62 mm
SVZ 100	100 mm	62 mm
SVZ 125	125 mm	62 mm
SVZ 150	150 mm	62 mm
SVZ 160	160 mm	62 mm
SVZ 200	200 mm	62 mm
SVZ 250	250 mm	62 mm
SVZ 315	315 mm	62 mm

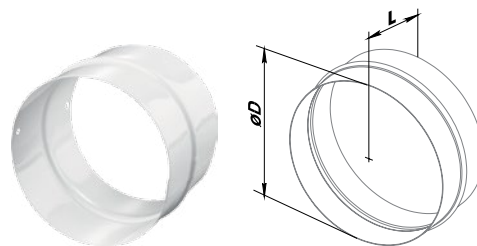

o **Flange with a plate for round ducts FQ**

- Made of white polymer coated steel (**FQM**) or galvanized steel (**FQZ**)
- Mounting with round air ducts
- Wall or ceiling mounting with screws

Model	Ø D	H	B	L (Length)
FQM 80	80 mm	130 × 130 mm	114 × 114 mm	50 mm
FQM 100	100 mm	150 × 150 mm	134 × 134 mm	50 mm
FQM 125	125 mm	170 × 170 mm	156 × 156 mm	50 mm
FQM 150	150 mm	204 × 204 mm	188 × 188 mm	50 mm
FQM 160	160 mm	210 × 210 mm	194 × 194 mm	50 mm
FQM 200	200 mm	250 × 250 mm	234 × 234 mm	50 mm
FQM 250	250 mm	300 × 300 mm	284 × 284 mm	50 mm
FQM 315	315 mm	360 × 360 mm	344 × 344 mm	50 mm
FQZ 80	80 mm	130 × 130 mm	114 × 114 mm	50 mm
FQZ 100	100 mm	150 × 150 mm	134 × 134 mm	50 mm
FQZ 125	125 mm	170 × 170 mm	156 × 156 mm	50 mm
FQZ 150	150 mm	204 × 204 mm	188 × 188 mm	50 mm
FQZ 160	160 mm	210 × 210 mm	194 × 194 mm	50 mm
FQZ 200	200 mm	250 × 250 mm	234 × 234 mm	50 mm
FQZ 250	250 mm	300 × 300 mm	284 × 284 mm	50 mm
FQZ 315	315 mm	360 × 360 mm	344 × 344 mm	50 mm

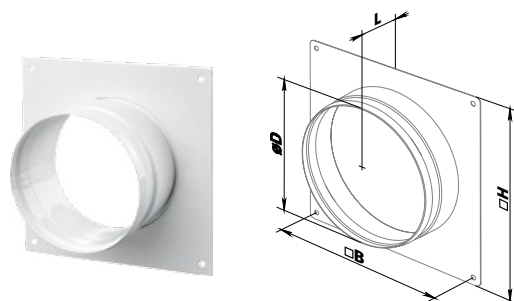

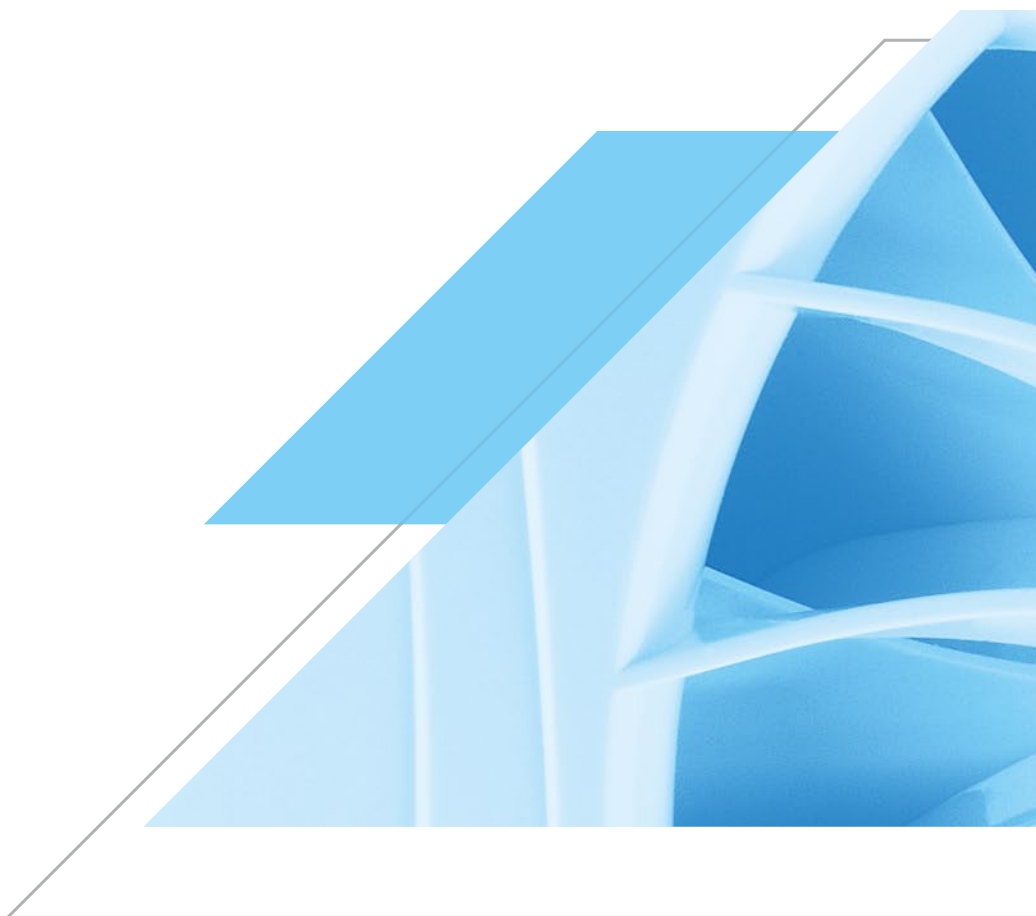

Blauberg Ventilatoren GmbH
Aidenbachstr. 52
D-81379 Munich

info@blaubergventilatoren.de
www.blaubergventilatoren.de

Technical changes reserved.
Illustrations and texts are non-binding.

02/2018