

Box-FI

Centrifugal fans in sound-insulated casing for rectangular ducts

Use

- Supply and extract ventilation systems installed in various premises.
- Compatible with 400x200 up to 1000x500 mm rectangular air ducts.



Air flow:
up to 9540 m³/h
2650 l/s



Power:
from 244 W



Noise level:
from 37 dBA



Design

- Atmospheric resistant galvanized steel casing and impeller.
- The casing is heat- and sound-insulated with 50 mm mineral wool.
- The fan is rated for continuous operation.
- Fitted with standard 20 mm connecting flanges for connection to rectangular air ducts.
- Access cover on the casing for inspection and maintenance operations.

Motor

- Four- or six-pole asynchronous motor with external rotor and centrifugal impeller with forward curved blades.
- Due to its impeller design the fan has excellent air dynamic characteristics (high performance and pressure drop).
- Single-phase (**E**) or three-phase (**D**) motor modifications.
- Equipped with ball bearings for longer service life.
- Dynamically balanced impeller.
- Overheating protection by built-in thermal switches with leaded outside terminals for connection to external protecting controls.
- The thermal switch terminal leads are designed for connection to respective circuit of the overload relay or respective terminals of the auto-transformer or thyristor speed controller.

Speed control

- Smooth speed control with an external thyristor controller or step speed control with an external auto transformer (both available upon separate order).

Mounting

- The fan is designed for mounting inside rectangular air ducts and can be installed in any position.
- The fan flanges are connected to the air ducts through the bolts inserted into the flange holes.
- Mounting to a round air duct on exhaust flange through a round pipe reducer. Available upon order.
- If flexible vibration-absorbing connectors are used to connect the fan to the air ducts provide their fixation to mounting structures with supports or brackets.
- While mounting provide enough space for accessing the cover for service operations.

INLINE FANS FOR RECTANGULAR DUCTS

Designation key

Series	Flange size (width x height) [cm]	Motor Number of poles	Phase
Box-FI	40x20; 50x25; 50x30; 60x30; 60x35; 70x40; 80x50; 90x50; 100x50	4; 6	E: single-phase D: three-phase

Accessories

Silencers	Filter boxes	Electric heaters	Water heaters	Air dampers	Flexible antivibration connectors
 SD	 KFBK / KFBT	 EKH	 WKH	 SL / VG	 EVA

Overall dimensions [mm]

Type	B	B1	B2	B3	H	H1	H2	H3	L	Weight [kg]
Box-FI 40x20 4E	400	420	440	470	200	220	240	360	500	29
Box-FI 40x20 4D	400	420	440	470	200	220	240	360	500	29
Box-FI 50x25 4E	500	520	540	570	250	270	290	410	640	40.5
Box-FI 50x25 4D	500	520	540	570	250	270	290	410	640	40.5
Box-FI 50x30 4E	500	520	540	570	300	320	340	460	680	52.5
Box-FI 50x30 4D	500	520	540	570	300	320	340	460	680	52.5
Box-FI 60x30 4E	600	620	640	670	300	320	340	480	680	56
Box-FI 60x30 4D	600	620	640	670	300	320	340	480	680	56
Box-FI 60x35 4E	600	620	640	670	350	370	390	530	735	72
Box-FI 60x35 4D	600	620	640	670	350	370	390	530	735	72
Box-FI 70x40 4D	700	720	-	800	400	420	-	620	880	103
Box-FI 80x50 4D	800	820	-	900	500	520	-	720	935	120
Box-FI 80x50 6D	800	820	-	900	500	520	-	720	935	127
Box-FI 90x50 6D	900	920	-	1000	500	520	-	720	1000	142
Box-FI 100x50 6D	1000	1020	-	1100	500	520	-	720	1000	150

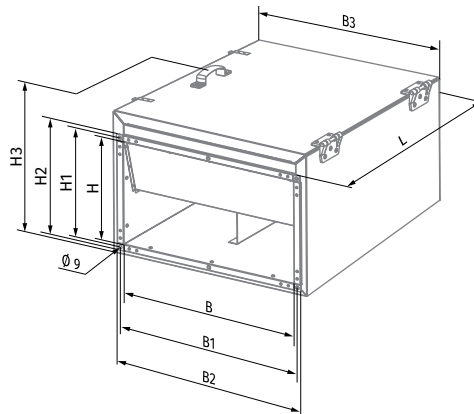

Technical data

Parameters	Box-FI 40x20 4E	Box-FI 40x20 4D	Box-FI 50x25 4E	Box-FI 50x25 4D	Box-FI 50x30 4E	Box-FI 50x30 4D	Box-FI 60x30 4E	Box-FI 60x30 4D
Voltage [V]	1 ~ 230	3 ~ 400	1 ~ 230	3 ~ 400	1 ~ 230	3 ~ 400	1 ~ 230	3 ~ 400
Frequency [Hz]	50	50	50	50	50	50	50	50
Power [W]	295	282	535	570	710	855	1240	1560
Current [A]	1.32	0.60	2.49	0.94	3.10	1.70	6.45	2.73
Maximum air flow [m ³ /h (l/s)]	1440 (400)	1470 (408)	1750 (486)	1850 (514)	2350 (653)	2350 (653)	2950 (820)	3740 (1039)
RPM [min ⁻¹]	1350	1300	1250	1270	1230	1300	1210	1310
Sound pressure at 3 m [dBA]	50	49	53	54	57	56	59	57
Transported air temperature [°C]	-25...+40	-25...+45	-20...+40	-20...+40	-25...+70	-20...+50	-25...+50	-25...+65
IP rating	IPX4	IPX4	IPX4	IPX4	IPX4	IPX4	IPX4	IPX4
Motor IP rating	IP44	IP44	IP44	IP44	IP44	IP44	IP44	IP44
ErP	-	-	-	2018	-	-	-	2018

BOX-FI 40x20 4E

Sound power level, A-weighted	Total	Octave frequency bands [Hz]								LpA 3 m	LpA 1 m
		63	125	250	500	1000	2000	4000	8000		
LWA to inlet [dBA]	82	68	80	74	70	66	63	63	53	61	71
LWA to outlet [dBA]	83	63	74	79	73	77	74	68	65	63	73
LWA to environment [dBA]	71	41	56	69	63	59	52	48	44	50	60

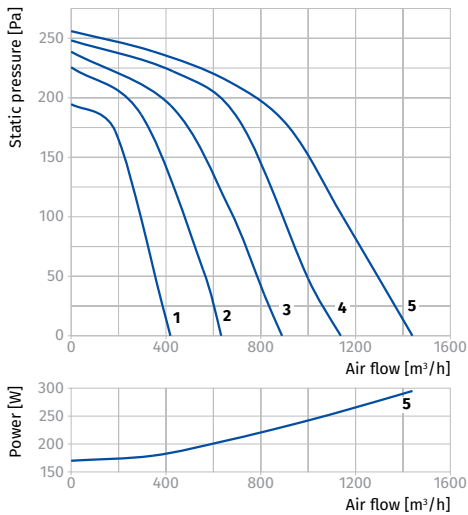
BOX-FI 40x20 4D

Sound power level, A-weighted	Total	Octave frequency bands [Hz]								LpA 3 m	LpA 1 m
		63	125	250	500	1000	2000	4000	8000		
LWA to inlet [dBA]	81	64	79	74	65	66	65	60	55	60	70
LWA to outlet [dBA]	80	62	74	75	70	72	68	70	63	60	70
LWA to environment [dBA]	70	41	53	68	63	61	53	48	40	49	59

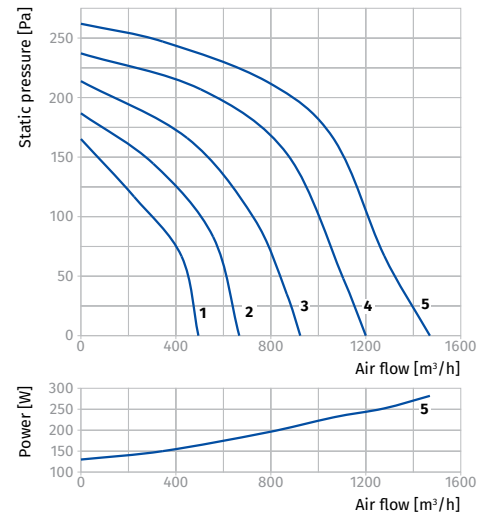
BOX-FI 50x25 4E

Sound power level, A-weighted	Total	Octave frequency bands [Hz]								LpA 3 m	LpA 1 m
		63	125	250	500	1000	2000	4000	8000		
LWA to inlet [dBA]	84	69	80	74	68	74	76	74	71	63	73
LWA to outlet [dBA]	86	66	72	71	76	83	79	78	72	66	76
LWA to environment [dBA]	74	50	60	66	65	69	64	63	65	53	63

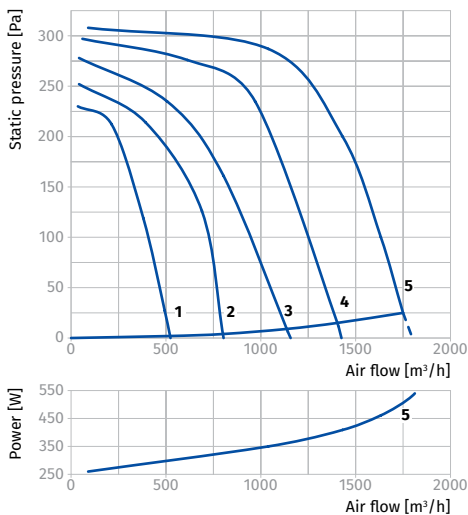

BOX-FI 50x25 4D

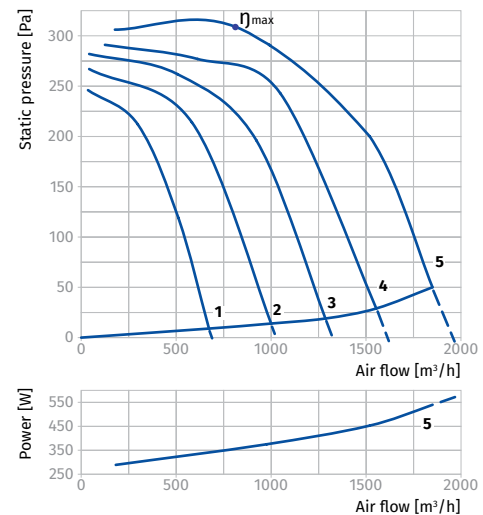
Sound power level, A-weighted	Total	Octave frequency bands [Hz]								LpA 3 m	LpA 1 m
		63	125	250	500	1000	2000	4000	8000		
LWA to inlet [dBA]	85	73	81	77	74	77	75	73	70	65	75
LWA to outlet [dBA]	88	68	77	77	80	82	82	81	75	68	78
LWA to environment [dBA]	75	51	60	66	66	70	65	63	66	54	64

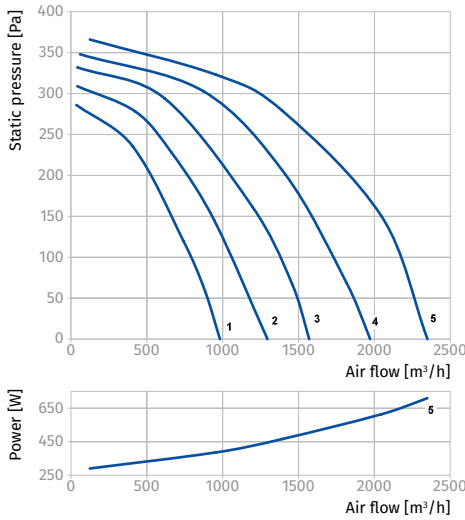

BOX-FI 50x30 4E

Sound power level, A-weighted	Total	Octave frequency bands [Hz]								LpA 3 m	LpA 1 m
		63	125	250	500	1000	2000	4000	8000		
LWA to inlet [dBA]	86	75	81	76	74	77	78	76	70	65	75
LWA to outlet [dBA]	88	69	77	74	81	82	81	80	72	67	77
LWA to environment [dBA]	78	57	66	73	67	72	69	61	62	57	67



BOX-FI 50x30 4D

Sound power level, A-weighted	Total	Octave frequency bands [Hz]								LpA 3 m	LpA 1 m
		63	125	250	500	1000	2000	4000	8000		
LWA to inlet [dBA]	85	76	79	71	72	78	78	76	72	64	74
LWA to outlet [dBA]	86	66	73	75	77	81	80	79	73	66	76
LWA to environment [dBA]	76	56	67	70	68	73	65	58	57	56	66

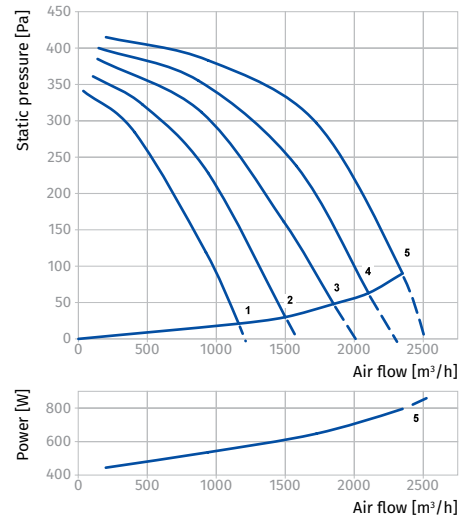

BOX-FI 60x30 4E

Sound power level, A-weighted	Total	Octave frequency bands [Hz]								LpA 3 m	LpA 1 m
		63	125	250	500	1000	2000	4000	8000		
LWA to inlet [dBA]	87	72	84	75	72	77	76	77	73	66	76
LWA to outlet [dBA]	89	67	73	77	80	85	82	79	72	68	78
LWA to environment [dBA]	80	48	75	76	70	71	64	61	54	59	69

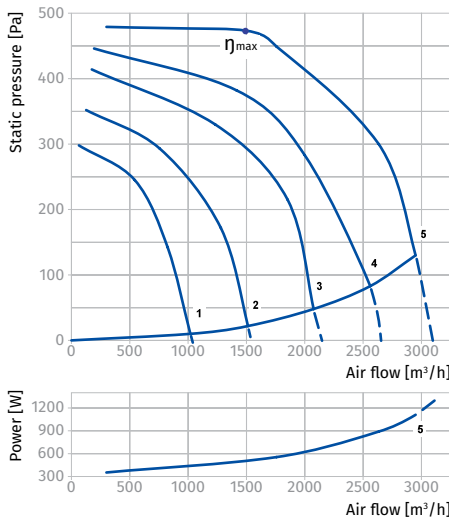

BOX-FI 60x30 4D

Sound power level, A-weighted	Total	Octave frequency bands [Hz]								LpA 3 m	LpA 1 m
		63	125	250	500	1000	2000	4000	8000		
LWA to inlet [dBA]	84	69	81	70	71	74	76	71	72	63	73
LWA to outlet [dBA]	86	64	78	73	78	81	77	78	69	66	76
LWA to environment [dBA]	77	49	71	70	72	70	62	55	58	57	67

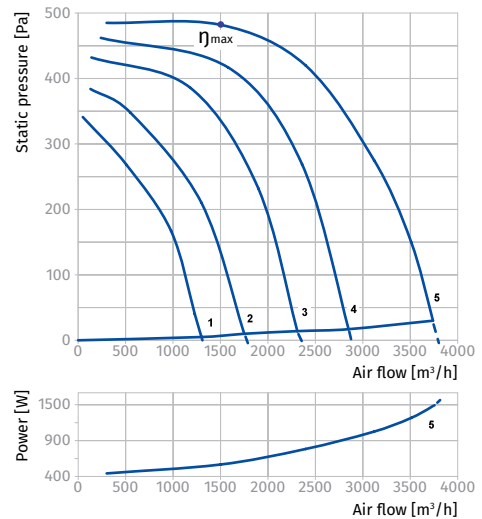

INLINE FANS FOR RECTANGULAR DUCTS

Parameters	Box-FI 60x35 4E	Box-FI 60x35 4D	Box-FI 70x40 4D	Box-FI 80x50 4D	Box-FI 80x50 6D	Box-FI 90x50 6D	Box-FI 100x50 6D
Voltage [V]	1 ~ 230	3 ~ 400	3 ~ 400	3 ~ 400	3 ~ 400	3 ~ 400	3 ~ 400
Frequency [Hz]	50	50	50	50	50	50	50
Power [W]	2840	2460	3630	5850	2790	3870	3870
Current [A]	13.90	3.93	6.00	9.35	5.18	7.0	7.0
Maximum air flow [m³/h (l/s)]	4260 (1183)	5020 (1395)	6450 (1792)	8120 (2256)	7610 (2114)	9540 (2650)	9540 (2650)
RPM [min ⁻¹]	1260	1300	1320	1140	830	930	930
Sound pressure at 3 m [dBA]	59	60	65	67	59	61	61
Transported air temperature [°C]	-20...+40	-20...+40	-25...+40	-25...+40	-20...+50	-20...+55	-20...+55
IP rating	IPX4	IPX4	IPX4	IPX4	IPX4	IPX4	IPX4
Motor IP rating	IP44	IP44	IP44	IP44	IP44	IP44	IP44
ErP	-	-	-	-	2018	-	-

BOX-FI 60X35 4E

Sound power level, A-weighted	Total	Octave frequency bands [Hz]								LpA 3 m	LpA 1 m
		63	125	250	500	1000	2000	4000	8000		
LWA to inlet [dBA]	85	76	79	70	71	80	77	75	68	65	75
LWA to outlet [dBA]	89	74	78	79	80	83	81	82	73	69	79
LWA to environment [dBA]	80	65	72	76	70	74	66	61	58	59	69

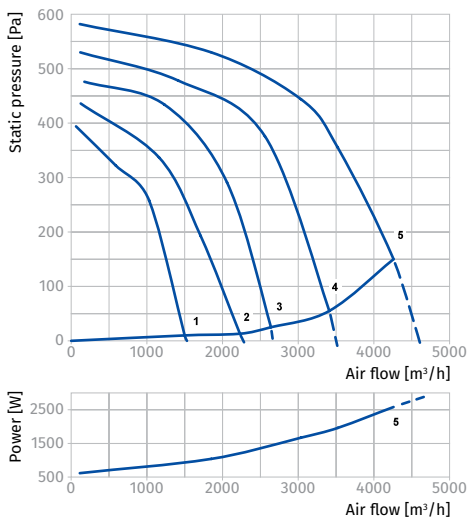

BOX-FI 60X35 4D

Sound power level, A-weighted	Total	Octave frequency bands [Hz]								LpA 3 m	LpA 1 m
		63	125	250	500	1000	2000	4000	8000		
LWA to inlet [dBA]	86	73	80	76	77	80	77	76	68	65	75
LWA to outlet [dBA]	90	67	77	78	86	83	78	83	69	70	80
LWA to environment [dBA]	80	69	70	77	69	72	70	59	50	60	70

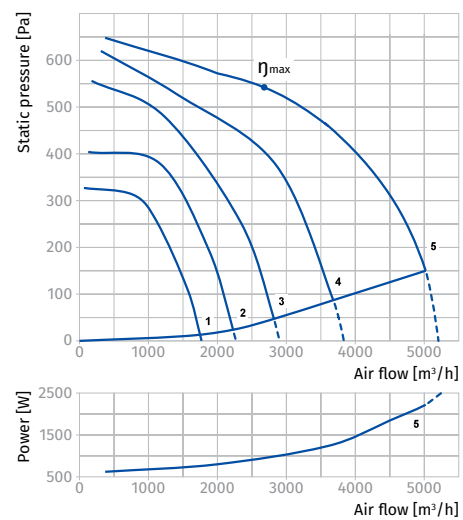

BOX-FI 70X40 4D

Sound power level, A-weighted	Total	Octave frequency bands [Hz]								LpA 3 m	LpA 1 m
		63	125	250	500	1000	2000	4000	8000		
LWA to inlet [dBA]	90	86	83	76	77	81	79	77	73	69	79
LWA to outlet [dBA]	92	78	82	79	82	87	85	81	75	71	81
LWA to environment [dBA]	86	64	74	80	78	81	73	72	68	65	75

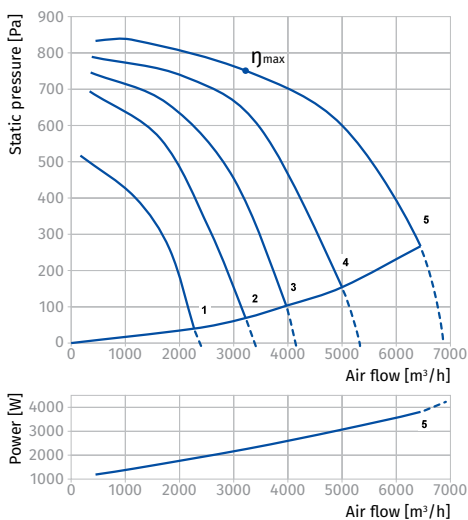

BOX-FI 80X50 4D

Sound power level, A-weighted	Total	Octave frequency bands [Hz]								LpA 3 m	LpA 1 m
		63	125	250	500	1000	2000	4000	8000		
LWA to inlet [dBA]	91	80	83	84	78	84	83	78	75	70	80
LWA to outlet [dBA]	96	77	82	81	88	92	91	86	83	76	86
LWA to environment [dBA]	87	72	80	79	77	83	78	72	71	67	77

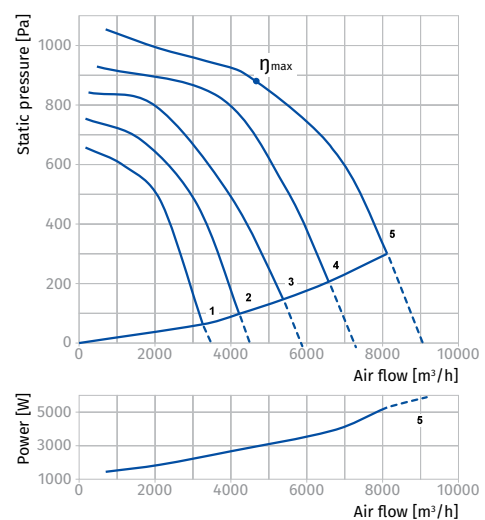

BOX-FI 80X50 6D

Sound power level, A-weighted	Total	Octave frequency bands [Hz]								LpA 3 m	LpA 1 m
		63	125	250	500	1000	2000	4000	8000		
LWA to inlet [dBA]	86	75	78	80	74	80	78	74	71	66	76
LWA to outlet [dBA]	90	71	76	75	81	85	84	79	77	69	79
LWA to environment [dBA]	80	65	73	72	70	75	71	65	64	59	69

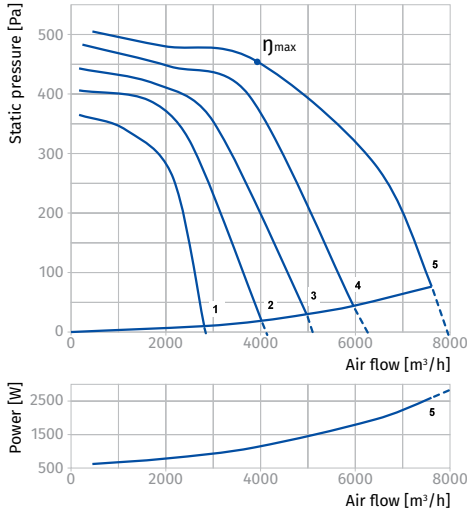

BOX-FI 90X50 6D

Sound power level, A-weighted	Total	Octave frequency bands [Hz]								LpA 3 m	LpA 1 m
		63	125	250	500	1000	2000	4000	8000		
LWA to inlet [dBA]	91	80	82	78	84	85	82	78	73	70	80
LWA to outlet [dBA]	99	78	80	86	97	90	89	88	78	79	89
LWA to environment [dBA]	81	64	68	79	74	71	70	66	58	61	71

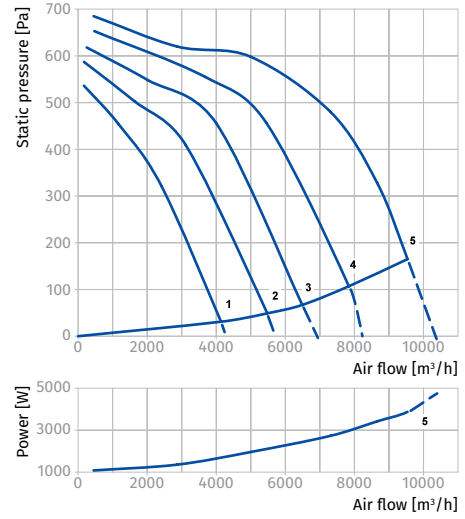

BOX-FI 100X50 6D

Sound power level, A-weighted	Total	Octave frequency bands [Hz]								LpA 3 m	LpA 1 m
		63	125	250	500	1000	2000	4000	8000		
LWA to inlet [dBA]	91	80	82	78	84	85	82	78	73	70	80
LWA to outlet [dBA]	99	78	80	86	97	90	89	88	78	79	89
LWA to environment [dBA]	81	64	68	79	74	71	70	66	58	61	71

