

CEILEO COMPACT DC

CENTRIFUGAL FANS

Low profile exhaust fans with low noise and power consumption for ceiling mounting



Air flow:
up to 187 m³/h
52 l/s



Power:
from 19 W
SFP:
from 0.37 W/l/s



Noise level:
from 23 dBA



Features



- Intermittent or continuous ventilation of bathrooms, showers, kitchens and other domestic spaces.
- For high-resistant ventilation systems.
- Integrated LED-light with low energy demand (**Ceileo Compact DC Light** models).
- The modular design enables easy connection of the optional humidity or motion sensors or the grille with a LED light.
- Constant air flow.
- Low noise level.
- The centrifugal impeller has forward curved blades for high pressure and low noise.
- The fan's impeller is made of high-quality durable ABS plastic.
- The fans also are equipped with a gravity backdraft damper.
- Ingress protection rating IPX4.
- Compatible with Ø 100 mm air ducts.

Motor

- The **Ceileo Compact DC** fan is equipped with a high efficient DC motor with low power consumption and electronic overheating protection. Constant air flow technology provides the necessary performance in a wide range of static pressure.

Design

- The casing is made of galvanized steel.
- The clip-on plastic grille ensures easy mounting and cleaning of the fan.
- The modular design of the grille enables easy retrofitting with the optional humidity or motion sensors.



- **Ceileo Compact DC Light** fans are equipped with an energy efficient LED light.

Power: 10 W
Colour temperature:
3 000 K
Luminous flux:
650 lumens



Power: 60 W

Plastic grille with LED light
(Ceileo Compact DC Light)

Plastic grille
(Ceileo Compact DC)



Assembled fan

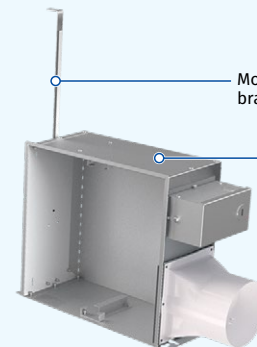

Mounting bracket

Casing

CEILEO COMPACT DC

CENTRIFUGAL FANS

Options

Ceileo Compact DC: Models with an adjustable turn-off and turn-on delay timer. This model can also be retrofitted with an optional humidity or motion sensor (available on a special order basis).

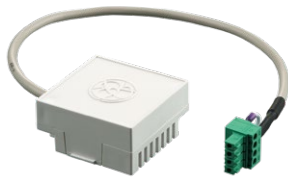

Humidity sensor

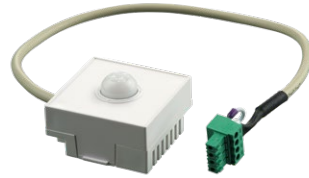

Motion sensor

Control

The built-in control panel of the **Ceileo Compact DC** fans enables the following settings:

- turn-on delay by timer
- turn-off delay by timer
- humidity level
- air flow for operating modes 1 and 2

Name	Adjustment range for operation modes 1 and 2
Ceileo Compact DC 110	Off / 100 / 120 / 135 / 155 / 170 / 190 m ³ /h

Ceileo Compact DC control panel



MANUAL CONTROL

The fan is controlled by means of the CDP-2/10 speed switch (available as a specially ordered accessory).



AUTOMATIC CONTROL



Timer: The fan is continuously running in the mode 1. Upon the light switch closing, the fan goes to mode 2 after the turn-on delay timer countdown (from 0 to 3 minutes). Upon the light switch is turned off the built-in turn-off delay timer keeps the fan running in the mode 2 from 1 to 90 minutes. On elapsing of this period the fan reverts to the mode 1.



Timer and humidity sensor (available as a specially ordered accessory): the fan runs continuously in the mode 1. If the indoor humidity level exceeds the sensor threshold value set in the 50-90 % range, the fan switches to the mode 2. When the humidity level reverts to the pre-set value, the built-in turn-off delay timer keeps the fan running in the mode 2 from 1 to 90 minutes. On elapsing of this period the fan reverts to the mode 1.



Timer and motion sensor (available as a specially ordered accessory): the fan runs continuously in the mode 1. If the motion sensor detects movement within its operation zone, the fan goes to the mode 2. When the movement is no longer registered, the built-in turn-off delay timer keeps the fan running in the mode 2 from 1 to 90 minutes. On elapsing of this period the fan reverts to the mode 1.

Overall dimensions

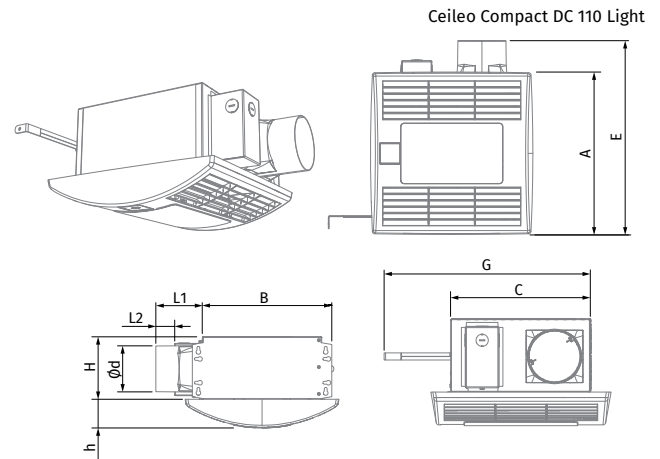
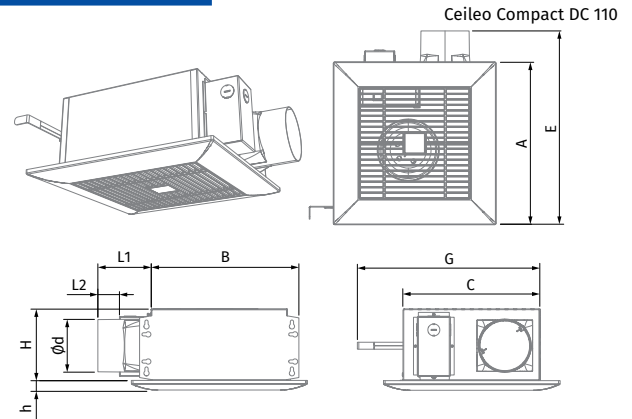

Dimensions [mm]	Ø d	L1	L2	A	B	C	E	H	h	G
Ceileo Compact DC 110	98	100	40.5	330	278	255	395	134	18	max 620
Ceileo Compact DC 110 Light	98	100	40.5	330	278	255	395	134	57	max 620

Mounting

- The fan is integrated into ceiling spaces.
- The fan is attached to the ceiling joists with a mounting bracket and self-tapping screws.
- The flexible air duct is attached to the fan exhaust spigot with a fixing clamp.
- Reduced casing height allows installing fans in ceilings with a thickness from 140 mm.



Designation key			
Ceileo Compact	DC	110	Light
Series	DC motor	Rated air flow [CFM]	LED-lamp available

CEILEO COMPACT DC

CENTRIFUGAL FANS

Technical data

Model	Ceileo Compact DC 110 Ceileo Compact DC 110 Light
Voltage [V/Hz]	120-240/50(60)
Speed	-
Power [W]	19
LED-light power [W]**	2 × 10
RPM [min ⁻¹]	1100
Current [A]	0.18
Air flow [m ³ /h (l/s)]	187 (52)
SFP [W/l/s]	0.37
Sound pressure level [dBA]*	from 23 to 25
Weight [kg]	5.3 (6.4**)
Ingress protection	IPX4
SEC class***	C

* Sound pressure level measured in free space at a distance of 3 meters from the fan.

** Only for the Light model

*** For fans with humidity or motion sensors



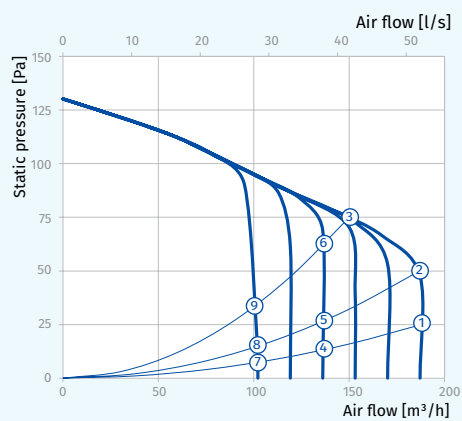





Point	Power [W]
1	17
2	19
3	16
4	9
5	12
6	15
7	4
8	4
9	6



CEILEO COMPACT DC

CENTRIFUGAL FANS

Accessories

Accessory name		Description	Ceileo Compact DC 110 (Light)
CDP-2/10		Speed switch	•
HS Ceileo		Humidity sensor	•
IRS Ceileo		Motion sensor	•
Decor S 102 HK		Stainless steel outer ventilation hood Ø 100 mm	•
Decor 155x155/100H		Outer ventilation hood Ø 100 mm	•
BlauFlex PVC/102/3		Flexible air duct Ø 100 mm, 3 m long	•
K 100		Quick-detachable stainless steel clamp Ø 90-110 mm	•
CH-PLC-10WG23		10 W LED-light with colour temperature 3000 K (only for the Light models)	•