

# KOMFORT RoTo EC L(E)HP

## Compact heat recovery air handling units

### Features

- Air handling units for efficient supply and exhaust ventilation in flats, houses, cottages and other buildings.
- For arranging of controlled energy saving ventilation systems.
- Controllable air exchange for creating the best suitable indoor microclimate.
- A fully integrated heat pump eliminates the need for installing the indoor and outdoor units of an air conditioner inside the treated space and on the building face. The heated or cooled air is distributed via a duct system to individual rooms for air distribution through air diffusers which gives the building a clean aesthetic look both inside and outside.
- Compatible with round Ø 160 and 250 mm air ducts.



**Air flow:**  
up to 955 m<sup>3</sup>/h  
265 l/s



**Heat recovery efficiency:**  
up to 85 %



### Design

- The casing load-bearing structure consists of three-layer zinc aluminium panels with a 25 mm fibreglass interlayer for noise and heat insulation.
- The spigots are located at the sides of the unit and are equipped with rubber seals for airtight connection to the air ducts.
- Specially designed removable side panels provide easy access to all the internal components of the air handling unit and reduce maintenance space requirements.
- **KOMFORT Roto EC LHP:** models with a rotary regenerator and heat pump with no preheating
- **KOMFORT Roto EC LEHP:** models with a rotary regenerator, heat pump and a supply air preheater

### Fans

- High-efficient external rotor EC motors and centrifugal impellers are used for air supply and exhaust.
- EC motors have the best power consumption to air flow ratio and meet the latest demands concerning energy saving and high-efficient ventilation.
- EC motors are featured with high performance, low noise level and totally controllable speed range.
- Dynamically balanced impellers.

### Air filtration

- The built-in G4 supply filter and G4 extract filter provide air filtration.
- A F7 supply filter (specially ordered accessory) may be used for efficient supply air filtration.

AIR HANDLING UNITS WITH ROTARY HEAT EXCHANGER

#### KOMFORT ROTO EC L(E)HP 400

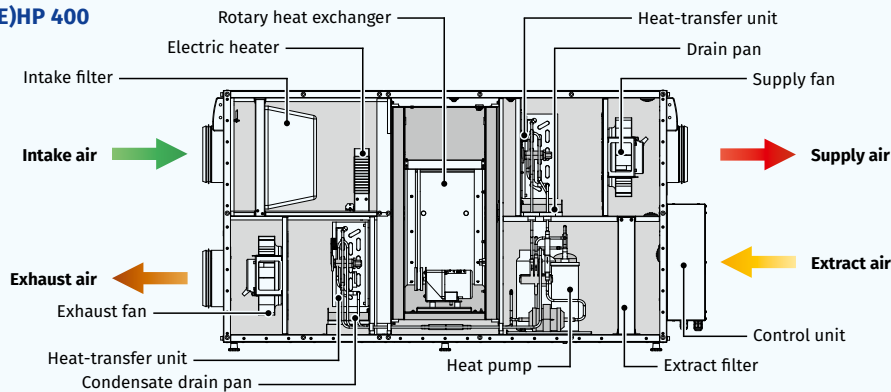

#### KOMFORT ROTO EC L(E)HP 700/900

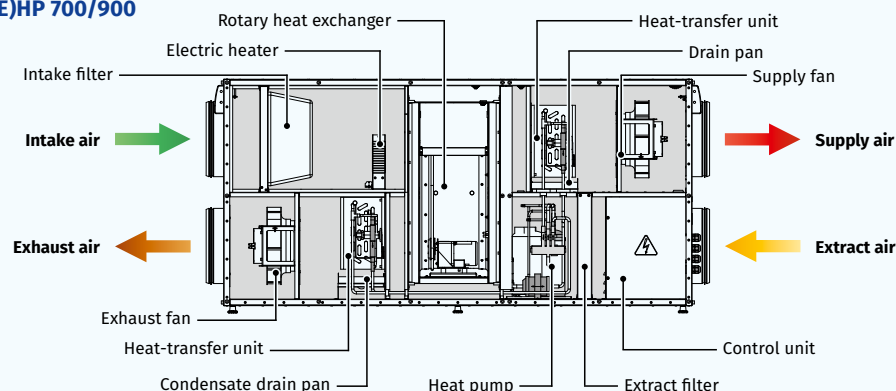

## Two-stage heat energy recovery system

- o **Stage I** – heat energy recovery in the rotary heat exchanger.
- o **Stage II** – booster heating/booster cooling in the heat pump.

## Heat recovery

- o The unit has a high-efficient rotary aluminium heat exchanger.
- o The rotary regenerator is a short, rotating cylinder, filled with corrugated aluminium sheet layers. The air streams flow through them.
- o The band layers of the heat regenerator first come in contact with the supply and then with extract air flows.
- o Therefore the band is alternatively warmed up and cooled down and the extract air heat and humidity are transferred to the cold intake air. This way heat recovery reduces heat losses in the cold season and reduces operation load for air conditioner in the warm season.
- o The advantages of the rotary regenerator as compared to the plate heat exchangers include no condensate generation, maintaining comfort air humidity and high freeze resistance.

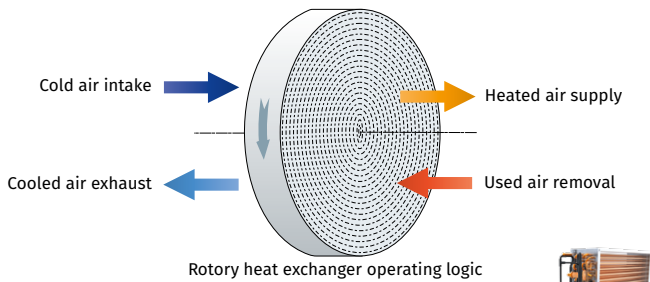

## Heat pump

- o The air handling unit features a reversible heat pump which can warm up or cool down the supply air stream using the extract air heat. A fully integrated heat pump eliminates the need for installing the indoor and outdoor units of an air conditioner inside the treated space and on the building face. The heated or cooled air is distributed via a duct system to individual rooms for air distribution through air diffusers which gives the building a clean aesthetic look both inside and outside.
- o This device transfers the extract air heat energy to the supply air stream. The amount of heat transferred is 2–6 times larger than the amount of electric energy used to power the process.
- o The heat pump is equipped with an array of protection systems including low and high pressure protection, freeze protection (automatic defrosting) and compressor overheating protection.
- o The heat pump utilizes a high-efficiency rotary compressor which generates minimum noise. Ozone-layer friendly R410A cooling agent is used as the heat pump working fluid.



## Air heater

- o The **KOMFORT Roto EC LEHP** unit is equipped with the optional posistor electric heater to warm up outdoor supply air at low temperatures.
- o Pre-heating reduces the number of heat pump defrosting cycles thus increasing the overall operational efficiency of the air handling unit.
- o The heater is divided into two active elements for reduced power electric power consumption while retaining sufficient heating capacity.

## Control and automation

- o The **KOMFORT Roto EC L(E)HP S17** units are equipped with the thTune control panel with an LCD display.
- o The **KOMFORT Roto EC L(E)HP S18** units are equipped with the pGD1 control panel with an LCD display.



## Unit operation modes

- o **"Auto" mode:** The unit runs in the automatic supply and exhaust mode maintaining a user-defined room temperature.
- o **"Heating" mode:** The unit ensures supply and exhaust ventilation of the treated space maintaining the room temperature above a pre-set threshold. As soon as the room temperature drops below the pre-set threshold the heat exchanger and the heat pump are engaged (in the heating mode).

- o **"Cooling" mode:** The unit ensures supply and exhaust ventilation of the treated space maintaining the room temperature below a pre-set threshold. As soon the room temperature exceeds the pre-set threshold the heat exchanger and the heat pump are engaged (in the cooling mode).
- o **"Heat Recovery" mode:** The unit runs in the supply and exhaust mode maintaining the room temperature by means of the heat exchanger only without engaging the heat pump. This mode is enabled automatically while in the "Auto", "Heating" or "Cooling" mode if the heat exchanger alone is able to maintain the user-defined room temperature without engaging the heat pump. This mode can also be enabled manually via the unit controller menu or the S18 (pGD1) control panel.
- o **"Ventilation" mode:** The unit ensures supply and exhaust ventilation of the treated space without maintaining a pre-set room temperature level. The heat exchanger and heat pump are disabled. Room temperature adjustment is not available. This operation mode is only available via the S18 (pGD1) control panel.
- o **"Defrosting" mode:** Enabled automatically (on elapsing of a pre-set time interval and/or on reaching a temperature threshold) while in the "Auto" and "Heating" modes to prevent the heat pump heat exchanger freezing. While in the "Defrosting" mode the fans are disabled. Upon the "Defrosting" mode deactivation the unit reverts to the previous operation mode automatically. While in the "Defrosting" mode user-selectable operation modes are not available.
- o **"Pre-Heating" mode:** While in the "Auto" or "Heating" modes at low ambient temperatures the supply air fed into the unit is warmed up by the electric pre-heater. This mode is enabled automatically upon the ambient temperature dropping below 8 °C. If the outdoor air temperature reaches above 8 °C the "Pre-Heating" mode is disabled. This mode is only available in factory configurations of the **KOMFORT Roto EC LEHP** models equipped with an electric heater. The "Pre-Heating" mode implementation in a **KOMFORT Roto EC LHP** requires upgrading the unit with a production electric heater (purchased separately) installed into the unit casing. The heater may only be installed by a service provider certified by the unit manufacturer.
- o **"Recirculation" mode:** This optional mode requires upgrading the unit with an external recirculation valve (purchased separately). The recirculation mode is enabled automatically at subzero ambient temperatures allowing a considerable reduction of unit energy consumption due to a partial redirection of the extract air into the supply duct of the unit.

## Intelligent unit control system

- o **Limit Function:** Reduces air flow automatically to maintain a user-defined temperature. If the unit cannot execute the user-defined room temperature setting after running in the "Auto" or "Heating" mode for 20 minutes the air flow rate (fan speed) is reduced automatically. The unit reverts to the original fan operation mode upon reaching the target air temperature as defined by the user. While in the "Limit Function" mode the air flow adjustment is not available.
- o **Warming-up:** Blocks cold air supply into the premises in the "Auto" or "Heating" mode. The effect is achieved by warming up the heat pump heat exchanger in the supply air duct while the supply fan remains disabled. The "Warming-up" mode is enabled after the "Defrosting" mode as well as upon the first start if the outdoor air temperature is below +10 °C. Upon completion of the "Warming-up" cycle the unit reverts to the original "Auto" or "Heating" mode.
- o **Higher Speed:** Increases air flow capacity automatically while in the "Cooling" mode to prevent excessive pressure build-up in the heat pump. The exhaust fan reverts to the initial speed once the pressure has dropped to normal.
- o **Smart Safe:** Automatically protects the unit from operating outside the safe performance range. The unit is equipped with an intelligent hardware protection system ensuring its safe and reliable performance within the permissible range of ambient temperature conditions. Therefore, the unit is able to adjust operating parameters or disable certain units and assemblies to compensate for abnormal operating conditions in order to prevent equipment failure.
- o **Heat Pump Protection:** Automatically prevents heat pump failure:
  - Protects against abnormally high or low pressure build-up. If the coolant pressure reaches beyond the safe performance range the pressure sensors send signals to the unit controller to power off the heat pump compressor. The compressor power is restored once the pressure has reverted to normal
  - Compressor thermal protection against overheating. The compressor is powered off when its casing temperature becomes abnormally high. The power is restored once the casing temperature has dropped to the normal performance range
  - Delayed Start. Protects the compressor from cycling (by blocking too frequent activation/deactivation of the compressor)

- **Serviceability:** The design solutions provide for easy access to the unit parts and components, facilitate its maintenance and replacement of the consumables and wear parts and ensure high serviceability of the entire air handling unit.
- **Fresh Air:** Ensures clean air supply into the treated spaces. The unit is equipped with a G4 filter (F7 filter optional). The control system monitors the filter performance automatically and generates replacement signals as necessary.
- **Ozone Protection:** The heat pump utilizes the R410A high-tech two-component cooling agent which does not deplete the ozone layer.
- **Save Energy:** A comprehensive engineering and technical approach to reducing the unit energy consumption which comprises the following elements:
  - Posistor electric pre-heater with two active elements
  - Upgraded thermal insulation of the supply chamber
  - Integral high-performance air-to-air heat pump
  - Adjustable fan speed
  - Automatic heat exchanger and heat pump activation/ deactivation
  - Electric heater deactivation in the "Defrosting" mode
  - Intelligent Blauberg Software – air handling unit control suite for maintaining optimum performance characteristics at low energy consumption based on the exclusive control algorithms
- **Low Noise:** A comprehensive engineering and technical approach to reducing the unit noise levels during operation comprising the following elements:
  - Heat pump integrated into the sound-proof unit casing
  - Adjustable-speed fans
  - Low-noise rotary compressor

- **Autorestart:** The unit memorizes the current operation mode and restores it after a power outage.
- **Simple Use:** The units are pre-assembled at the factory and are ready for operation. The installation and maintenance costs are reduced to a bare minimum. The unit operation does not require any special training due to a clean-cut user-friendly interface.
- **CO<sub>2</sub> Control:** Maintains the CO<sub>2</sub> level in the treated space below a user-defined value. If the CO<sub>2</sub> level in the indoor space exceeds the pre-set value the air handling unit increases the air exchange rate automatically. This option is only available with the external CO<sub>2</sub> control sensor with a 0–10 V output signal (purchased separately).
- **RH Control:** Maintains the relative humidity level in the treated space below a user-defined value. Should the relative humidity become abnormally high the unit increases the air exchange rate automatically. This option is only available with the S17 (th-Tune) control panel in a special configuration or the external relative humidity control sensor with a 0–10 V output signal (purchased separately).
- **Rapid Access to Set Mode:** The larger the difference between the outdoor temperature and the pre-set indoor temperature, the faster the heat pump is activated.

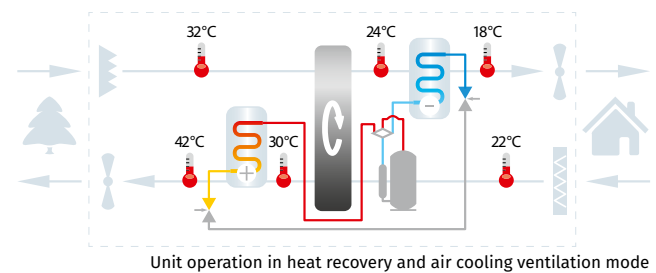
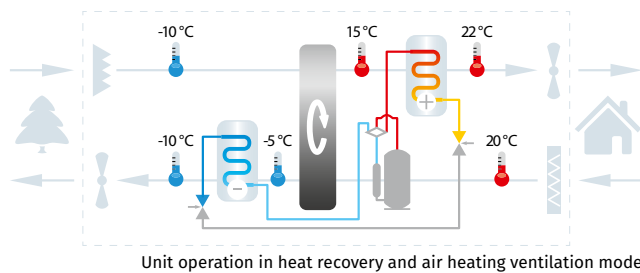

**Designation key**

Series	Unit type	Motor type	Spigot modification	Heater type	Modification	Rated air flow [m <sup>3</sup> /h]	Control
KOMFORT	<b>Roto:</b> rotary heat exchanger	<b>EC:</b> electronically commutated motor	<b>L:</b> horizontal spigot orientation	<b>-:</b> without heater <b>E:</b> electric heater	<b>HP:</b> heat pump	<b>400; 700; 900</b>	<b>S17:</b> thTune control panel <b>S18:</b> pGD1 control panel

**Overall dimensions [mm]**

Model	D	B	H	L	L1
KOMFORT Roto EC L(E)HP 400	159	648	710	1250	1421
KOMFORT Roto EC L(E)HP 700	249	748	750	1667	-
KOMFORT Roto EC L(E)HP 900	249	748	750	1667	-

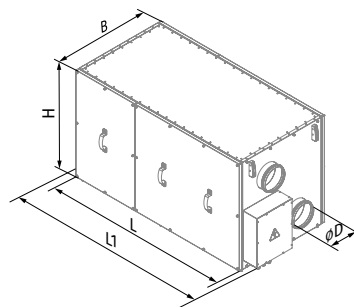

KOMFORT Roto EC L(E)HP 400

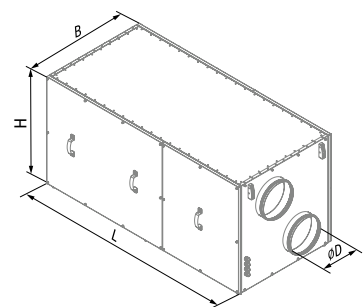

KOMFORT Roto EC L(E)HP 700  
KOMFORT Roto EC L(E)HP 900

## Technical data

Total parameters	KOMFORT Roto EC LHP 400 S17/S18	KOMFORT Roto EC LHP 700 S17/S18	KOMFORT Roto EC LHP 900 S17/S18	KOMFORT Roto EC LEHP 400 S17/S18	KOMFORT Roto EC LEHP 700 S17/S18	KOMFORT Roto EC LEHP 900 S17/S18
Maximum air flow [m³/h (l/s)]	520 (53)	830 (231)	955 (265)	520 (53)	830 (231)	955 (265)
Maximum transported air temperature [°C]	-10...+40	-10...+40	-10...+40	-25...+40	-25...+40	-25...+40
Heat recovery efficiency [%]	up to 85	up to 85	up to 85	up to 85	up to 85	up to 85
Sound pressure at 3 m [dBA]	45	52	58	45	52	58
Casing material	aluzinc	aluzinc	aluzinc	aluzinc	aluzinc	aluzinc
Weight [kg]	150	160	165	150	160	165
Connected air duct diameter [mm]	160	250	250	160	250	250
Heat exchanger type	rotary	rotary	rotary	rotary	rotary	rotary
Heat exchanger material	aluminium	aluminium	aluminium	aluminium	aluminium	aluminium
Air exhaust filter	G4	G4	G4	G4	G4	G4
Air supply filter	G4 (option: F7)	G4 (option: F7)	G4 (option: F7)	G4 (option: F7)	G4 (option: F7)	G4 (option: F7)

Electrical parameters						
Air-handling unit supply voltage [V / 50 Hz]	1 ~ 230	1 ~ 230	1 ~ 230	1 ~ 230	1 ~ 230	1 ~ 230
Maximum power consumption in "Heat Recovery" mode [kW]	0.31	0.36	0.46	0.31	0.36	0.46
Maximum power consumption in "Heat Recovery + Heat Pump" mode [kW]	0.745	0.94	1.195	0.745	0.94	1.195
Maximum power consumption in "Heat Recovery + Heat Pump + Pre-Heating" mode [kW]	-	-	-	2.145	3.74	3.995
Maximum current consumption [A]	4.6	5.7	6.7	10.9	18.5	19.4
Air-handling unit energy efficiency "Heating" mode (COP)	6	6.5	6.5	6	6.5	6.5
Air-handling unit energy efficiency "Cooling" mode (ERR)	4	4.15	4.25	4	4.15	4.25

Heat pump characteristics						
Coolant	R410A	R410A	R410A	R410A	R410A	R410A
Coolant weight [kg]	0.8	1.6	2	0.8	1.6	2
Heat output in "Heating" mode [W] at $t_o = +7\text{ °C}$ ; $t_k = +45\text{ °C}^*$	1560	2600	3250	1560	2600	3250
Heat output in "Cooling" mode [W] at $t_o = +7\text{ °C}$ ; $t_k = +45\text{ °C}^*$	1200	2000	2500	1200	2000	2500
Compressor type	Sealed, rotary type	Sealed, rotary type	Sealed, rotary type	Sealed, rotary type	Sealed, rotary type	Sealed, rotary type
Temperature setting range in "Cooling/Heating" modes [°C]	+16...+30	+16...+30	+16...+30	+16...+30	+16...+30	+16...+30

\* $t_o$  – coolant boiling temperature;  $t_k$  – coolant condensation temperature.

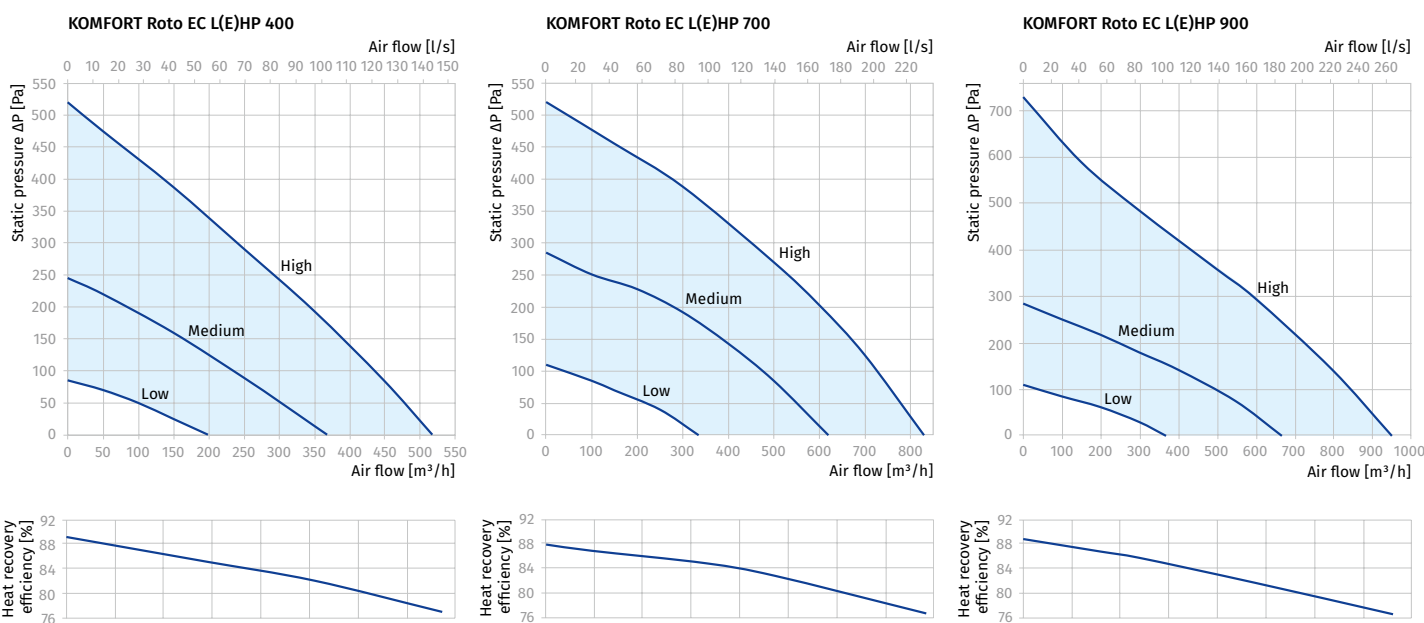

## Heat pump characteristics in the "HEATING" mode

### KOMFORT ROTO EC L(E)HP 400

Speed	Air flow rate		Room air temperature [°C]		Temperature at fresh air intake [°C]		Temperature of outdoor air supplied to treated space [°C]		Electric power consumption [kW]	COP* <sub>1</sub> [W/W]	COP* <sub>2</sub> [BTU/W]	Q <sub>heat,1</sub> [kW]
	% of max	[m³/h]	Dry-bulb temperature	Wet-bulb temperature (relative humidity)	Dry-bulb temperature	Wet-bulb temperature (relative humidity)	Dry-bulb temperature	Wet-bulb temperature (relative humidity)				
High	100	400	20	12 (~38 %)	7	6 (~86 %)	26	14 (~25 %)	0.585	4.3	14.8	2.53
Medium	70	280	20	12 (~38 %)	7	6 (~86 %)	28	15 (~23 %)	0.485	4	13.8	1.96
Low	40	160	20	12 (~38 %)	7	6 (~86 %)	35	17 (~14 %)	0.475	3.1	10.7	1.49
High	100	400	20	12 (~38 %)	2	1 (~80 %)	25	12 (~18 %)	0.580	5.3	18	3.07
Medium	70	280	20	12 (~38 %)	2	1 (~80 %)	27	13 (~17 %)	0.475	4.9	16.8	2.33
Low	40	160	20	12 (~38 %)	2	1 (~80 %)	34	16 (~12.5 %)	0.465	3.7	12.5	1.71
High	100	400	20	12 (~38 %)	-7	-8 (~70 %)	21	8 (~8 %)	0.560	7.1	24.4	4
Medium	70	280	20	12 (~38 %)	-7	-8 (~70 %)	22	9 (~8 %)	0.450	6.4	21.9	2.89
Low	40	160	20	12 (~38 %)	-7	-8 (~70 %)	25	10 (~8 %)	0.440	4.1	14.1	1.81

\*Important! The temperature parameters and the COP and ERR factors were defined at the temperature-humidity conditions as per the EN 13141 -7:2010 standard. The factors were calculated based on the assumption of continuous heat pump operation whereas the cyclic heat pump operation was disregarded.

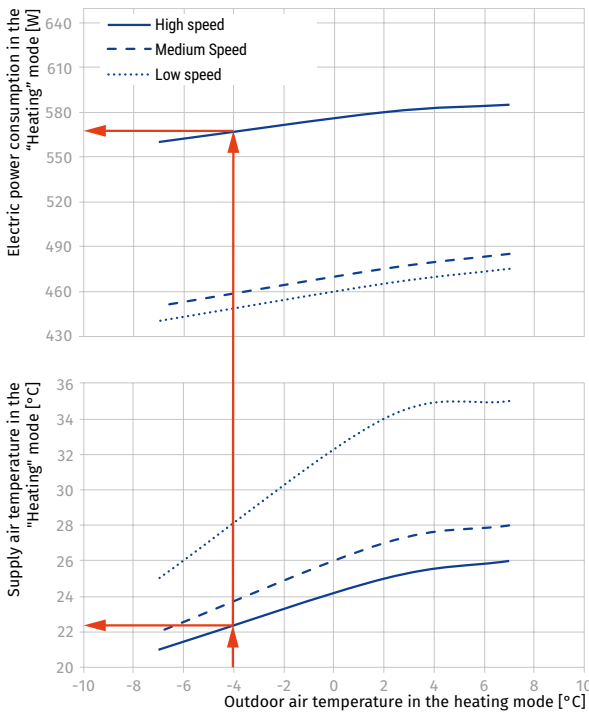

## Heat pump characteristics in the "COOLING" mode

### KOMFORT ROTO EC L(E)HP 400

Speed	Air flow rate		Room air temperature [°C]		Temperature at fresh air intake [°C]		Temperature of outdoor air supplied to treated space [°C]		Electric power consumption [kW]	COP*, [W/W]	COP*, [BTU/W]	Q <sub>cool</sub> [kW]
	% of max	[m³/h]	Dry-bulb temperature	Wet-bulb temperature (relative humidity)	Dry-bulb temperature	Wet-bulb temperature (relative humidity)	Dry-bulb temperature	Wet-bulb temperature (relative humidity)				
High	100	400	27	19 (~47.5 %)	35	24 (~40 %)	23	21 (~85 %)	0.664	2.4	8.2	1.6
Medium	70	280	27	19 (~47.5 %)	35	24 (~40 %)	22	20.5 (~85 %)	0.560	2.2	7.4	1.21
Low	40	160	27	19 (~47.5 %)	35	24 (~40 %)	20	19 (~90 %)	0.554	1.8	6.2	1.01
High	100	400	27	19 (~47.5 %)	27	19 (~47.5 %)	19	16.5 (~78 %)	0.619	1.7	5.9	1.07
Medium	70	280	27	19 (~47.5 %)	27	19 (~47.5 %)	18	15.5 (~78 %)	0.522	1.6	5.5	0.84
Low	40	160	27	19 (~47.5 %)	27	19 (~47.5 %)	15	14 (~88 %)	0.495	1.6	5.5	0.8

\*Important! The temperature parameters and the COP and ERR factors were defined at the temperature-humidity conditions as per the EN 13141 -7:2010 standard. The factors were calculated based on the assumption of continuous heat pump operation whereas the cyclic heat pump operation was disregarded.

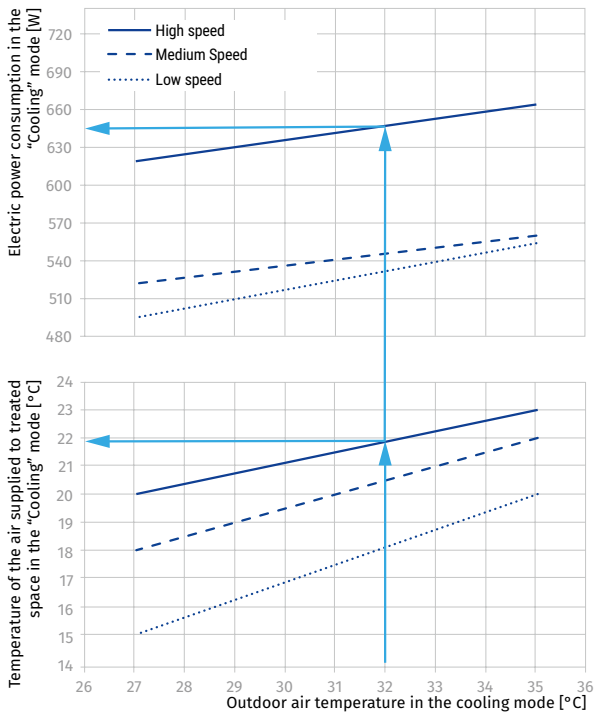

## Heat pump characteristics in the "HEATING" mode

### KOMFORT ROTO EC L(E)HP 700

Speed	Air flow rate		Room air temperature [°C]		Temperature at fresh air intake [°C]		Temperature of outdoor air supplied to treated space [°C]		Electric power consumption [kW]	COP* <sub>1</sub> [W/W]	COP* <sub>2</sub> [BTU/W]	Q <sub>heat,1</sub> [kW]
	% of max	[m³/h]	Dry-bulb temperature	Wet-bulb temperature (relative humidity)	Dry-bulb temperature	Wet-bulb temperature (relative humidity)	Dry-bulb temperature	Wet-bulb temperature (relative humidity)				
High	100	700	20	12 (~38 %)	7	6 (~86 %)	26	14 (~25 %)	0.695	6.4	21.8	4.43
Medium	70	490	20	12 (~38 %)	7	6 (~86 %)	28	15 (~23 %)	0.580	5.9	20.2	3.43
Low	40	280	20	12 (~38 %)	7	6 (~86 %)	35	17 (~14 %)	0.520	5.0	17.1	2.61
High	100	700	20	12 (~38 %)	2	1 (~80 %)	25	12 (~18 %)	0.690	7.8	26.5	5.37
Medium	70	490	20	12 (~38 %)	2	1 (~80 %)	27	13 (~17 %)	0.570	7.2	24.4	4.08
Low	40	280	20	12 (~38 %)	2	1 (~80 %)	34	16 (~12.5 %)	0.505	5.9	20.2	2.99
High	100	700	20	12 (~38 %)	-7	-8 (~70 %)	21	8 (~8 %)	0.670	10.4	35.6	7.00
Medium	70	490	20	12 (~38 %)	-7	-8 (~70 %)	22	9 (~8 %)	0.555	9.1	31.1	5.06
Low	40	280	20	12 (~38 %)	-7	-8 (~70 %)	25	10 (~8 %)	0.485	6.5	22.3	3.17

\*Important! The temperature parameters and the COP and ERR factors were defined at the temperature-humidity conditions as per the EN 13141 -7:2010 standard. The factors were calculated based on the assumption of continuous heat pump operation whereas the cyclic heat pump operation was disregarded.

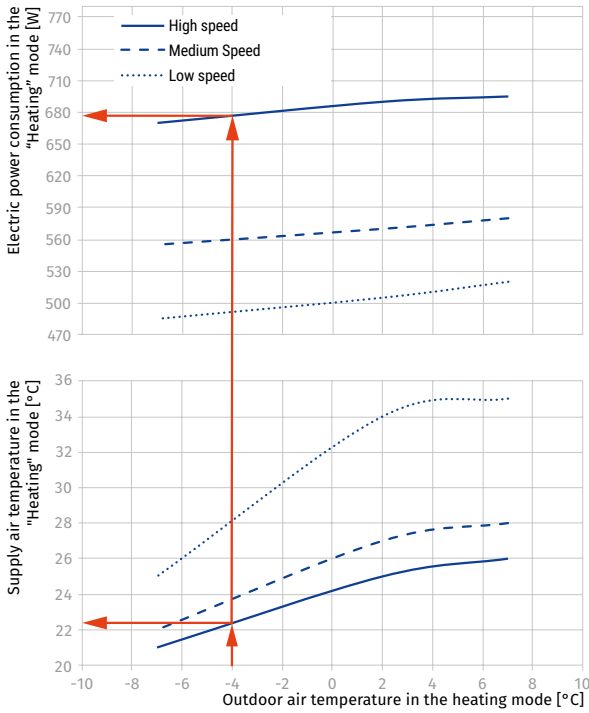

AIR HANDLING UNITS WITH ROTARY HEAT EXCHANGER

## Heat pump characteristics in the “COOLING” mode

### KOMFORT ROTO EC L(E)HP 700

Speed	Air flow rate		Room air temperature [°C]		Temperature at fresh air intake [°C]		Temperature of outdoor air supplied to treated space [°C]		Electric power consumption [kW]	COP*, [W/W]	COP*, [BTU/W]	Q <sub>cool</sub> [kW]
	% of max	[m³/h]	Dry-bulb temperature	Wet-bulb temperature (relative humidity)	Dry-bulb temperature	Wet-bulb temperature (relative humidity)	Dry-bulb temperature	Wet-bulb temperature (relative humidity)				
High	100	700	27	19 (~47.5 %)	35	24 (~40 %)	23	21 (~85 %)	0.780	3.6	12.2	2.8
Medium	70	490	27	19 (~47.5 %)	35	24 (~40 %)	22	20.5 (~85 %)	0.660	3.2	11	2.12
Low	40	280	27	19 (~47.5 %)	35	24 (~40 %)	20	19 (~90 %)	0.605	2.9	10	1.77
High	100	700	27	19 (~47.5 %)	27	19 (~47.5 %)	19	16.5 (~78 %)	0.735	2.5	8.7	1.87
Medium	70	490	27	19 (~47.5 %)	27	19 (~47.5 %)	18	15.5 (~78 %)	0.580	2.5	8.6	1.47
Low	40	280	27	19 (~47.5 %)	27	19 (~47.5 %)	15	14 (~88 %)	0.540	2.2	7.7	1.21

\*Important! The temperature parameters and the COP and ERR factors were defined at the temperature-humidity conditions as per the EN 13141 -7:2010 standard. The factors were calculated based on the assumption of continuous heat pump operation whereas the cyclic heat pump operation was disregarded.

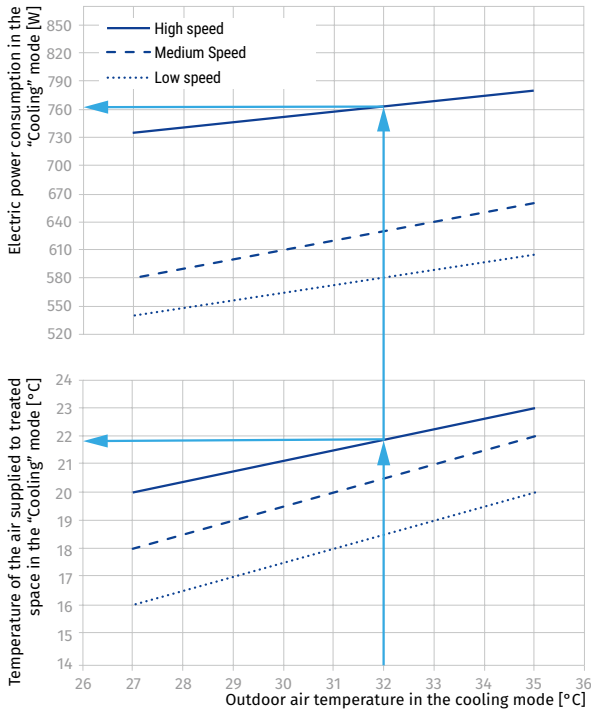



## Heat pump characteristics in the "HEATING" mode

### KOMFORT ROTO EC L(E)HP 900

Speed	Air flow rate		Room air temperature [°C]		Temperature at fresh air intake [°C]		Temperature of outdoor air supplied to treated space [°C]		Electric power consumption [kW]	COP* [W/W]	COP* [BTU/W]	Q <sub>heat</sub> [kW]
	% of max	[m³/h]	Dry-bulb temperature	Wet-bulb temperature (relative humidity)	Dry-bulb temperature	Wet-bulb temperature (relative humidity)	Dry-bulb temperature	Wet-bulb temperature (relative humidity)				
High	100	900	20	12 (~38 %)	7	6 (~86 %)	26	14 (~25 %)	855	6.7	22.7	5.70
Medium	70	630	20	12 (~38 %)	7	6 (~86 %)	28	15 (~23 %)	750	5.9	20.1	4.41
Low	40	360	20	12 (~38 %)	7	6 (~86 %)	35	17 (~14 %)	695	4.8	16.5	3.36
High	100	900	20	12 (~38 %)	2	1 (~80 %)	25	12 (~18 %)	847	8.1	27.8	6.90
Medium	70	630	20	12 (~38 %)	2	1 (~80 %)	27	13 (~17 %)	735	7.1	24.4	5.25
Low	40	360	20	12 (~38 %)	2	1 (~80 %)	34	16 (~12.5 %)	680	5.6	19.3	3.84
High	100	900	20	12 (~38 %)	-7	-8 (~70 %)	20	8 (~8 %)	818	11.0	37.5	9.00
Medium	70	630	20	12 (~38 %)	-7	-8 (~70 %)	21	9 (~8 %)	700	9.3	31.7	6.51
Low	40	360	20	12 (~38 %)	-7	-8 (~70 %)	23	10 (~14 %)	643	6.3	21.7	4.08

\*Important! The temperature parameters and the COP and ERR factors were defined at the temperature-humidity conditions as per the EN 13141 -7:2010 standard. The factors were calculated based on the assumption of continuous heat pump operation whereas the cyclic heat pump operation was disregarded.

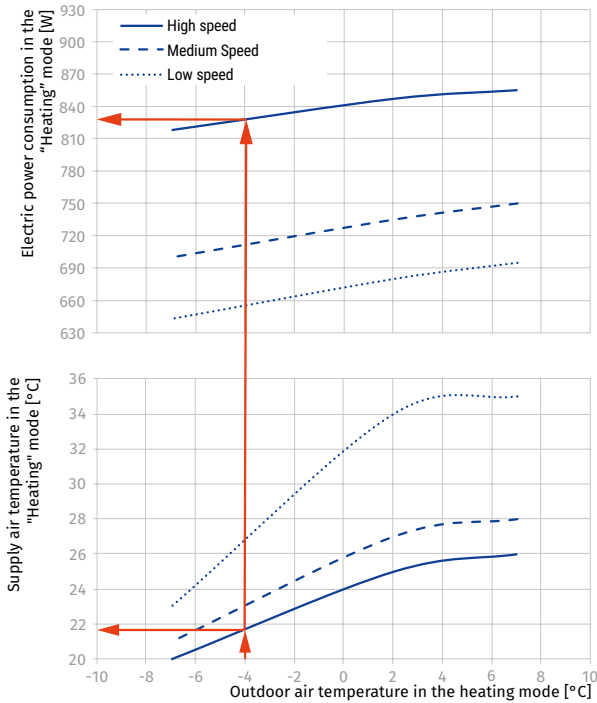

## Heat pump characteristics in the "COOLING" mode







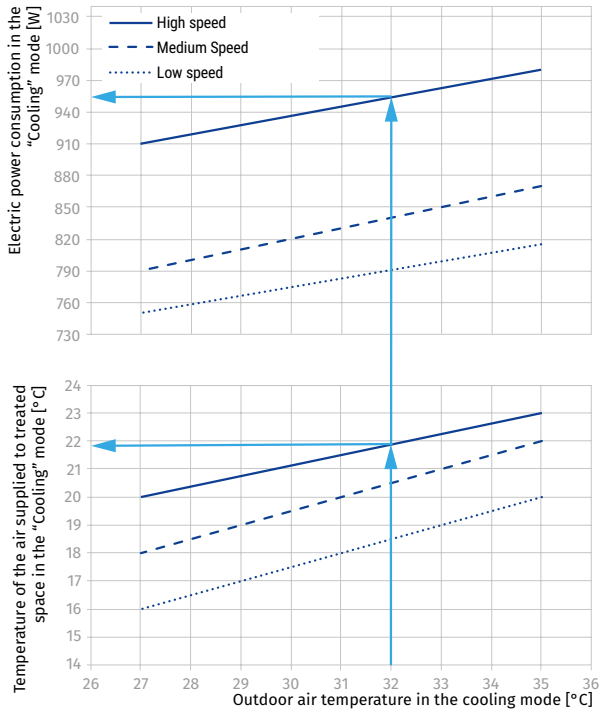





### KOMFORT ROTO EC L(E)HP 900

Speed	Air flow rate		Room air temperature [°C]		Temperature at fresh air intake [°C]		Temperature of outdoor air supplied to treated space [°C]		Electric power consumption [kW]	COP*, [W/W]	COP*, [BTU/W]	Q <sub>cool</sub> , [kW]
	% of max	[m³/h]	Dry-bulb temperature	Wet-bulb temperature (relative humidity)	Dry-bulb temperature	Wet-bulb temperature (relative humidity)	Dry-bulb temperature	Wet-bulb temperature (relative humidity)				
High	100	900	27	19 (~47.5 %)	35	24 (~40 %)	23	21 (~85 %)	0.980	3.7	12.5	3.60
Medium	70	630	27	19 (~47.5 %)	35	24 (~40 %)	22	20.5 (~85 %)	0.870	3.1	10.7	2.73
Low	40	360	27	19 (~47.5 %)	35	24 (~40 %)	20	19 (~90 %)	0.815	2.8	9.5	2.28
High	100	900	27	19 (~47.5 %)	27	19 (~47.5 %)	19	16.5 (~78 %)	0.910	2.6	9	2.40
Medium	70	630	27	19 (~47.5 %)	27	19 (~47.5 %)	18	15.5 (~78 %)	0.790	2.4	8.2	1.89
Low	40	360	27	19 (~47.5 %)	27	19 (~47.5 %)	15	14 (~88 %)	0.750	2.1	7.1	1.56

\*Important! The temperature parameters and the COP and ERR factors were defined at the temperature-humidity conditions as per the EN 13141 -7:2010 standard. The factors were calculated based on the assumption of continuous heat pump operation whereas the cyclic heat pump operation was disregarded.



**Accessories**

		KOMFORT Roto EC L(E)HP 400 S17/S18	KOMFORT Roto EC L(E)HP 700 S17/S18	KOMFORT Roto EC L(E)HP 900 S17/S18
G4 panel filter		FP 600x332x48 G4	FP 700x352x48 G4	FP 700x352x48 G4
G4 pocket filter		FPT 600x330x27 G4	FPT 700x351x27 G4	FPT 700x351x27 G4
F7 pocket filter		FPT 600x330x27 F7	FPT 700x351x27 F7	FPT 700x351x27 F7
Backdraft air damper		VRV 160	VRV 250	VRV 250
Air damper		VKA 160	VKA 250	VKA 250
Humidity sensor		FS2	FS2	FS2
Humidity sensor		HR-S	HR-S	HR-S
VOC sensor		DPWQ30600	DPWQ30600	DPWQ30600
External CO <sub>2</sub> sensor		DPWQ40200	DPWQ40200	DPWQ40200
Humidity sensor		DPWC11200	DPWC11200	DPWC11200
Electric actuator		LF230	LF230	LF230
Electric actuator		TF230	TF230	TF230