

RENEO D

Heat and energy recovery air handling units

Features

- Air handling units for efficient supply and exhaust ventilation in flats, houses, cottages and other buildings.
- Heat recovery minimizes ventilation heat losses during the cold season and reduces air conditioner load during the hot season.
- Controllable air exchange for creating the best suitable indoor microclimate.
- Compatible with round 160 mm air ducts.



Air flow:
up to 313 m³/h
87 l/s



Heat recovery efficiency:
up to 91 %



COMING
SOON

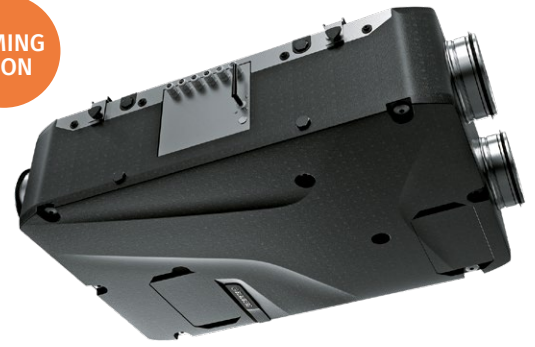

Design

- The casing is made of expanded polypropylene (EPP) with high heat- and sound-insulating properties.
- The **Reneo D 181 / 241** units have flat service hatch design, suitable for decorative panel installation (delivered separately).

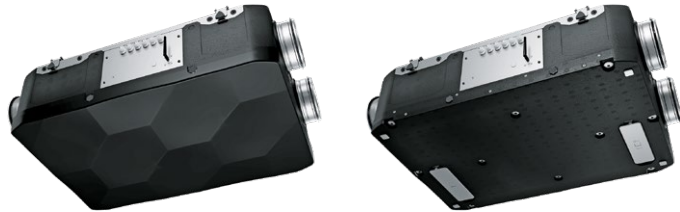

Fans

- High-efficient external rotor **EC** motors and centrifugal impellers with forward-curved blades are used for air supply and exhaust.

Air filtration

- Two built-in **Coarse 90% (G4)** filters provide efficient supply air filtration.
- Supply **ePM1 65% (F7)** filter available as an option.

EPP HEAT AND ENERGY RECOVERY AIR HANDLING UNITS



Heat recovery

- The **Reneo D** unit is equipped with a counter-flow polyesterene heat exchanger for heat recovery. The condensate is collected and drained to the drain pan under the heat exchanger.
- The **Reneo D...-E** unit is equipped with an enthalpy counter-flow heat exchanger for heat and humidity recovery.

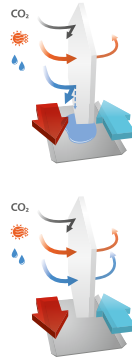

Control and automation

- Reneo D S21** units are equipped with an integrated automation system. The remote control panel is not included in the delivery set.
- The S21 controller allows integrating the unit into the **Smart Home** system or **BMS (Building Management System)**.
- Unit control via Wi-Fi using the mobile application **Blauberg Home**.



Download the **Blauberg Home** app for Android



Download the **Blauberg Home** app for iOS

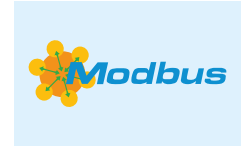





Bypass

- The **Reneo D** units are equipped with a bypass, which can be opened if there is a need to cool down the ventilated area with cool intake air.

Mounting

- The units are designed for suspended ceiling mounting, floor mounting, vertical or horizontal wall mounting.

Automation functions

Functions	Reneo D S21	Reneo D S14
Unit control via Wi-Fi using a mobile application	+	-
Unit control via a wired remote control panel	S22 control panel (option) 	S14 control panel 
Unit control via a wireless remote control panel	S22 Wi-Fi control panel (option) 	-
Unit control via a remote wired LCD control panel	S25 control panel (option) 	-
BMS (Building Management System)	RS-485	-
	Wi-Fi	-
	Ethernet	-
	MODBUS (RTU, TCP)	-
Blauberg Cloud Server service	+	-
Speed selection	+	+
Filter replacement indication	by filter timer	by filter timer
	by filter clogging differential pressure switch	-
Alarm indication	full alarm description in the mobile application	LED alarm indication
Week-scheduled operation	+	-
Bypass	automatic	-
	manual	manual
Timer	+	-
Boost mode	+	-
Fireplace mode	+	-
Freeze protection	through cyclic stops of the supply fan	through cyclic stops of the supply fan
	through preheating (option)	-
Reheater connection	option	-
Cooler connection	option	-
Minimum supply air temperature control	+	-
Humidity control	option	option
CO ₂ control	option	option
VOC control	option	-
PM2.5 control	option	-
Fire alarm sensor connection	option	option

Option: the function is available when purchasing the appropriate accessory (see the "Accessories" section).

Designation key

Series	Casing type	Nominal size	Modification	Heat exchanger type	Controller type
Reneo	D: suspended	18: Nominal airflow	0: standard 1: flat design with an option for attaching a decorative panel	- : heat recovery E: energy recovery	S21 S14

Overall dimensions [mm]

Model	∅ D	H	L	L1	W	W1
Reneo D	160	272	930	627	640	300

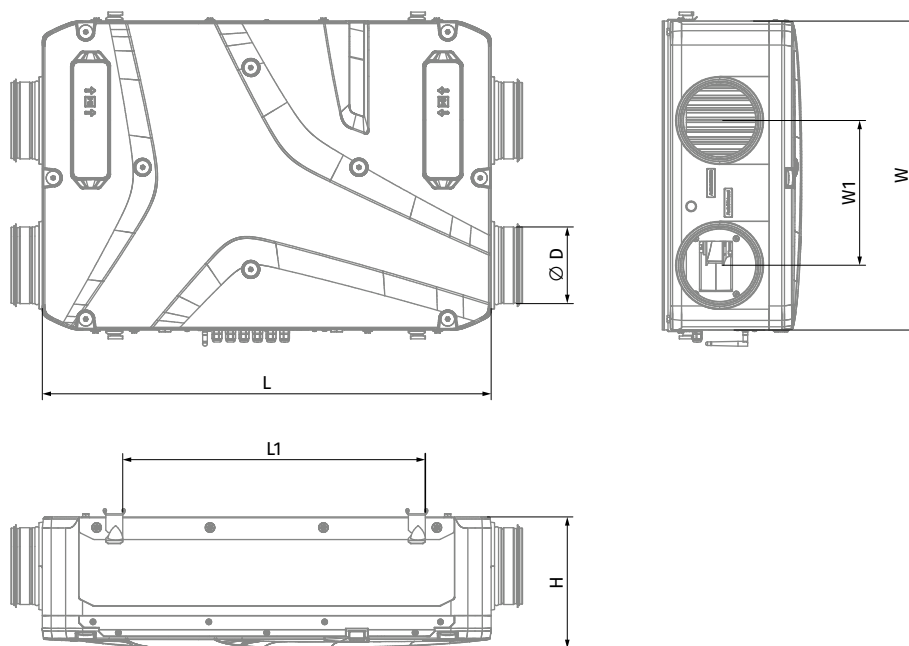

Technical data

Parameters	Reneo D 180	Reneo D 180-E	Reneo D 240	Reneo D 240-E
Voltage [V / 50-60 Hz]	230	230	230	230
Max. unit power [W]	54	54	168	168
Max. unit current [A]	0.46	0.46	1.3	1.3
Max air flow [m³/h]	191	191	313	313
Sound pressure level at 3 m distance [dBA]	34	34	35	35
Max. operating temperature [°C]	45	45	45	45
Case material	EPP	EPP	EPP	EPP
Insulation	25 mm	25 mm	25 mm	25 mm
Extract filter	Coarse >60 %	Coarse >60 %	Coarse >60 %	Coarse >60 %
Supply filters	Coarse >60 % (G4) (option: ePM1 60 % (F7))	Coarse >60 % (G4) (option: ePM1 60 % (F7))	Coarse >60 % (G4) (option: ePM1 60 % (F7))	Coarse >60 % (G4) (option: ePM1 60 % (F7))
Connected air duct diameter [mm]	160	160	160	160
Weight [kg]	12	15	13	16
Heat recovery efficiency [%]	91	82	90	79
Heat exchanger type	counter-flow	counter-flow	counter-flow	counter-flow
Heat exchanger material	polystyrene	enthalpy membrane	polystyrene	enthalpy membrane
SEC class	A+	A	A	A

RENEO D 180

Sound power level, A-weighted	Total	Octave frequency band [Hz]								LpA 3 m	LpA 1 m
		63	125	250	500	1000	2000	4000	8000		
Point 1											
LWA to environment [dBA]	61	33	41	40	56	53	47	44	34	42	51
Point 4											
LWA to environment [dBA]	52	29	37	36	41	43	39	34	28	34	42





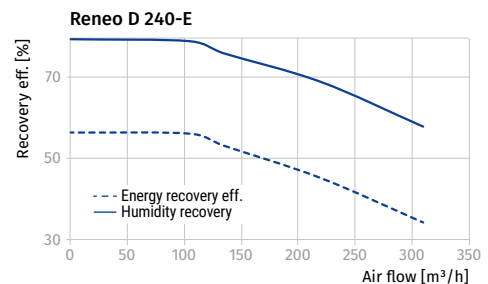
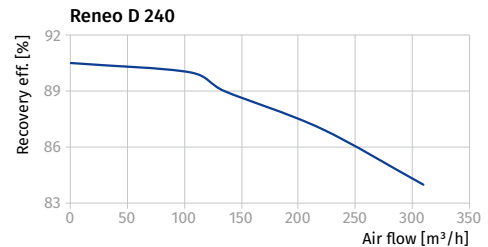
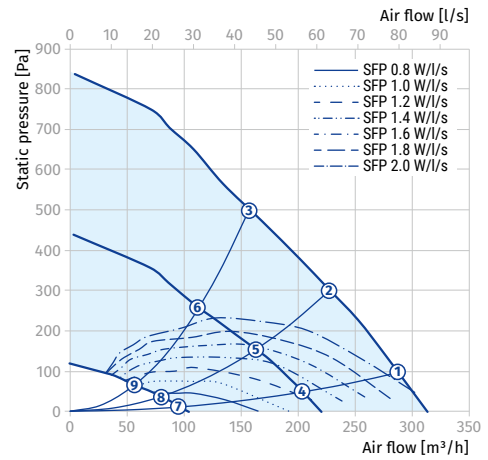
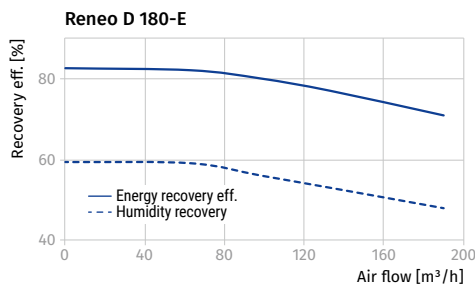
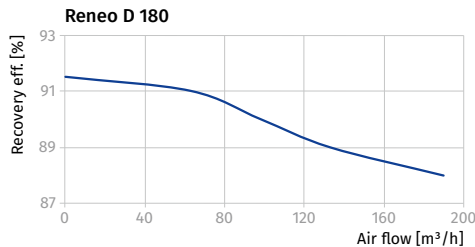
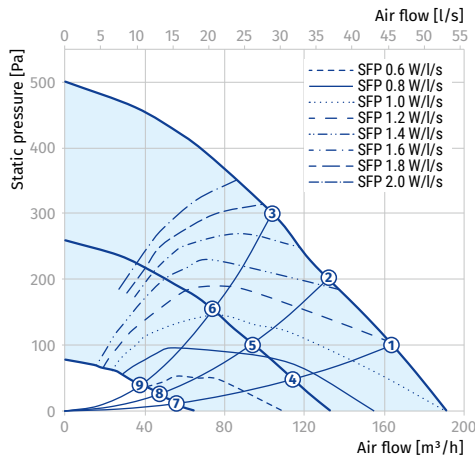











RENEO D 240

Sound power level, A-weighted	Total	Octave frequency band [Hz]								LpA 3 m	LpA 1 m
		63	125	250	500	1000	2000	4000	8000		
Point 1											
LWA to environment [dBA]	60	36	44	43	49	51	46	43	40	41	50
Point 4											
LWA to environment [dBA]	54	30	38	37	43	44	40	36	29	34	43



EPP HEAT AND ENERGY RECOVERY AIR HANDLING UNITS

Accessories

		Reneo D 180(-E) S21	Reneo D 181(-E) S21	Reneo D 180(-E) S14	Reneo D 181(-E) S14
G4 panel filter		FP 205x200x48 Coarse 90% G4	FP 205x200x48 Coarse 90% G4	FP 205x200x48 Coarse 90% G4	FP 205x200x48 Coarse 90% G4
F7 panel filter		FP 205x200x48 ePM1 60% F7	FP 205x200x48 ePM1 60% F7	FP 205x200x48 ePM1 60% F7	FP 205x200x48 ePM1 60% F7
Decorative panel		-	EP-Reneo D 181	-	EP-Reneo D 181
LCD control panel		S25	S25	-	-
Control panel		S22	S22	-	-
Wireless control panel		S22 Wi-Fi	S22 Wi-Fi	-	-
Internal humidity sensor		FS2	FS2	FS2	FS2
Internal CO ₂ sensor		CD-3	CD-3	CD-3	CD-3
CO ₂ sensor with indication		CD-1	CD-1	CD-1	CD-1
CO ₂ sensor		CD-2	CD-2	CD-2	CD-2
Humidity sensor		HR-S	HR-S	HR-S	HR-S
Electric preheater		EVH 160 S21 V.2	EVH 160 S21 V.2	-	-
Electric reheater		ENH 160 S21 V.2	ENH 160 S21 V.2	-	-
Syphon kit (for the units without an enthalpy heat exchanger)		SFK 20x32	SFK 20x32	SFK 20x32	SFK 20x32
Silencer		SD 160	SD 160	SD 160	SD 160
Air damper		VKA 160	VKA 160	VKA 160	VKA 160
Electric actuator		TF230	TF230	TF230	TF230

		Reneo D 240(-E) S21	Reneo D 241(-E) S21	Reneo D 240(-E) S14	Reneo D 241(-E) S14
G4 panel filter		FP 205x200x48 Coarse 90% G4	FP 205x200x48 Coarse 90% G4	FP 205x200x48 Coarse 90% G4	FP 205x200x48 Coarse 90% G4
F7 panel filter		FP 205x200x48 ePM1 60% F7	FP 205x200x48 ePM1 60% F7	FP 205x200x48 ePM1 60% F7	FP 205x200x48 ePM1 60% F7
Decorative panel		-	EP-Reneo D 181	-	EP-Reneo D 181
LCD control panel		S25	S25	-	-
Control panel		S22	S22	-	-
Wireless control panel		S22 Wi-Fi	S22 Wi-Fi	-	-
Internal humidity sensor		FS2	FS2	FS2	FS2
Internal CO ₂ sensor		CD-3	CD-3	CD-3	CD-3
CO ₂ sensor with indication		CD-1	CD-1	CD-1	CD-1
CO ₂ sensor		CD-2	CD-2	CD-2	CD-2
Humidity sensor		HR-S	HR-S	HR-S	HR-S
Electric preheater		EVH 160 S21 V.2	EVH 160 S21 V.2	-	-
Electric reheater		ENH 160 S21 V.2	ENH 160 S21 V.2	-	-
Syphon kit (for the units without an enthalpy heat exchanger)		SFK 20x32	SFK 20x32	SFK 20x32	SFK 20x32
Silencer		SD 160	SD 160	SD 160	SD 160
Air damper		VKA 160	VKA 160	VKA 160	VKA 160
Electric actuator		TF230	TF230	TF230	TF230