

# RENEO S 350

## Heat and energy recovery air handling units

COMING SOON



### Features

- Air handling units for efficient supply and exhaust ventilation in flats, houses, cottages and other buildings.
- Heat recovery minimizes ventilation heat losses during the cold season and reduces air conditioner load during the hot season.
- Controllable air exchange for creating the best suitable indoor microclimate.
- Compatible with round 160 mm air ducts.



**Air flow:**  
up to 410 m<sup>3</sup>/h  
114 l/s



**Heat recovery efficiency:**  
up to 92 %



### Design

- The casing is made of expanded polypropylene (EPP) with high heat- and sound-insulating properties.
- **Reneo S 350 L** – left-handed unit
- **Reneo S 350 R** – right-handed unit
- The **Reneo S 351** units have flat service hatch design, suitable for decorative panel installation (delivered separately).



### Air filtration

- Two built-in **Coarse 90% (G4)** filters provide efficient supply air filtration.
- Supply **ePM1 65% (F7)** filter is available as an option.

### Bypass

- The **Reneo S** units are equipped with a bypass, which can be opened if there is a need to cool down the ventilated area with cool intake air.

### Fans

- The unit is equipped with high-efficiency **EC** external rotor motors and centrifugal impellers with forward-curved blades.

RENEO S 350 L

RENEO S 350 R

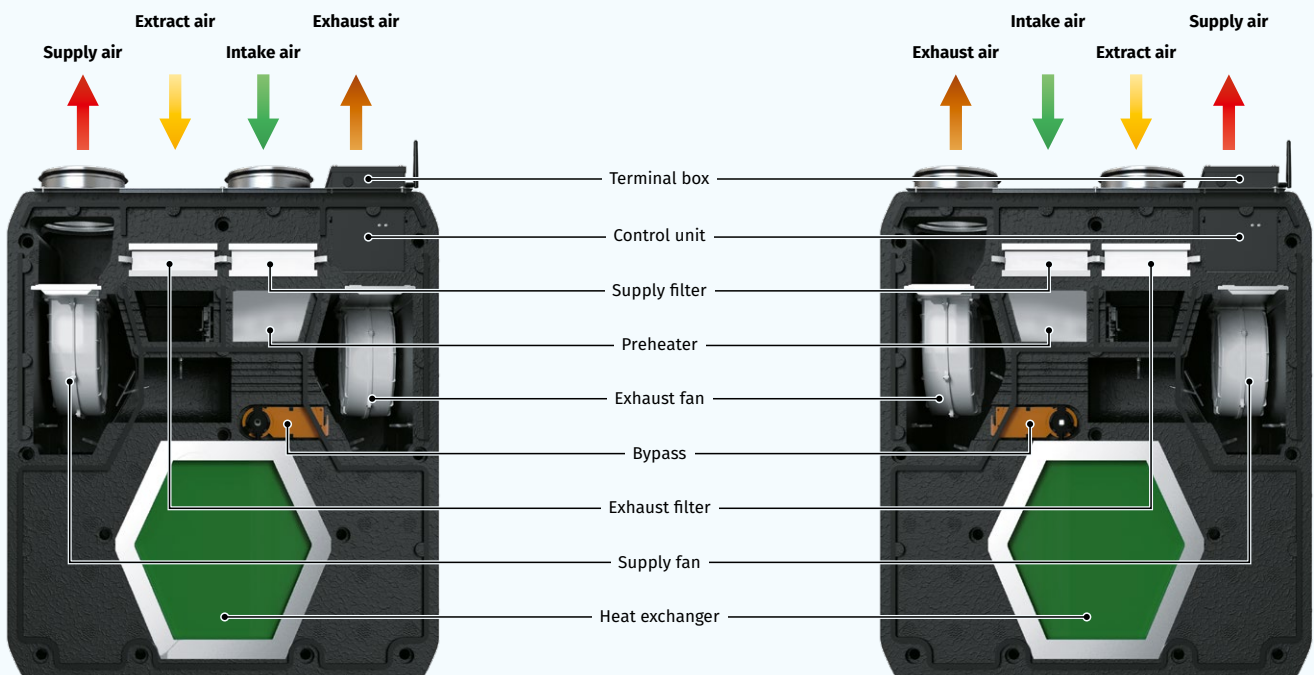

### Heat recovery

- The **Reneo S** unit is equipped with a counter-flow polystyrene heat exchanger for heat recovery. The condensate is collected and drained to the drain pan under the heat exchanger.
- The **Reneo S...-E** unit is equipped with an enthalpy counter-flow heat exchanger for heat and humidity recovery.



### Control and automation

- Reneo S S21** units are equipped with an integrated automation system. The remote control panel is not included in the delivery set.
- The S21 controller allows to integrate the unit into the **Smart Home** system or **BMS (Building Management System)**.
- Unit control is done via Wi-Fi using the mobile application **Blauberg Home**.



Download the **Blauberg Home** app for Android



Download the **Blauberg Home** app for iOS

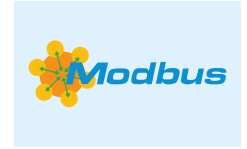





### Mounting

- The units are designed for suspended ceiling mounting, floor mounting, vertical or horizontal wall mounting

- The **Reneo S S14** units are equipped with an integrated automation system and an S14 wall-mounted sensor control panel.

### Automation functions

Functions	Reneo S S21	Reneo S S14
Unit control via Wi-Fi using a mobile application	+	-
Unit control via a wired remote control panel	S22 control panel (option) 	S14 control panel 
Unit control via a wireless remote control panel	S22 Wi-Fi control panel (option) 	-
Unit control via a wired remote LCD control panel	S25 control panel (option) 	-
BMS (Building Management System)	RS-485	-
	Wi-Fi	-
	Ethernet	-
	MODBUS (RTU, TCP)	-
Blauberg Cloud Server service	+	-
Speed selection	+	+
Filter replacement indication	by filter timer by filter clogging differential pressure switch	by filter timer -
Alarm indication	full alarm description in the mobile application	LED alarm indication
Week-scheduled operation	+	-
Bypass	automatic	-
	manual	manual
Timer	+	-
Boost mode	+	-
Fireplace mode	+	-
Freeze protection	through cyclic stops of the supply fan	through cyclic stops of the supply fan
	through preheating (option)	-
Reheater connection	option	-
Cooler connection	option	-
Minimum supply air temperature control	+	-
Humidity control	option	option
CO <sub>2</sub> control	option	option
VOC control	option	-
PM2.5 control	option	-
Fire alarm sensor connection	option	option

Option: the function is available when purchasing the appropriate accessory (see the "Accessories" section).

**Designation key**

Series	Casing type	Heater	Nominal size	Modification	Heat exchanger type	Unit version	Controller type
Reneo	S: vertical	-: w/o heater E: integrated preheater	35: nominal airflow	0: standard 1: flat service hatch suitable for decorative panel installation	-: heat recovery E: energy recovery	L: left-handed R: right-handed	S21 S14

**Overall dimensions [mm]**

Model	Ø D	H	H1	L	L1	W	W1
Reneo S	160	880	939	616	230	770	355

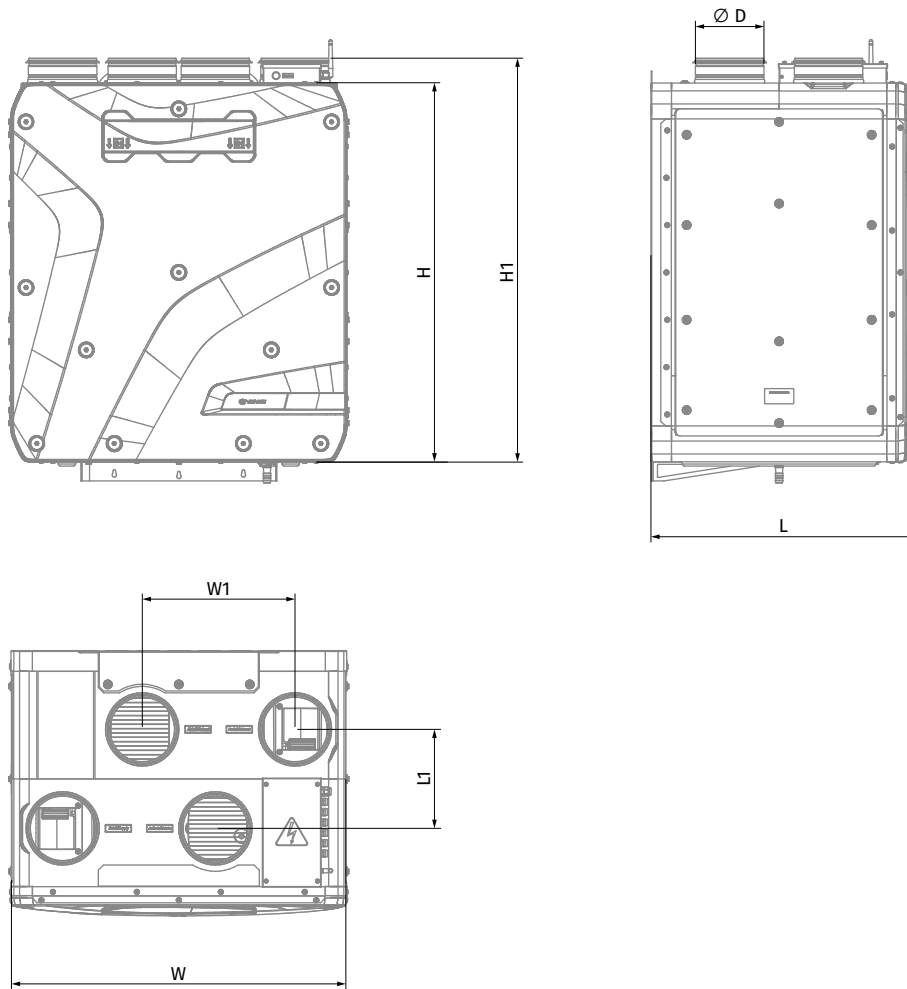

EPP HEAT AND ENERGY RECOVERY AIR HANDLING UNITS

### Technical data





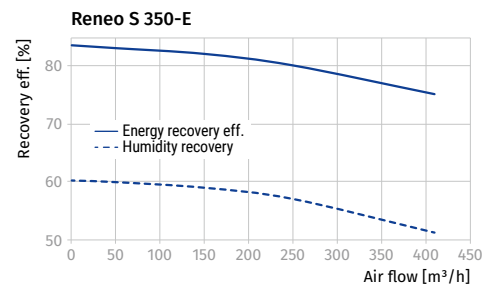
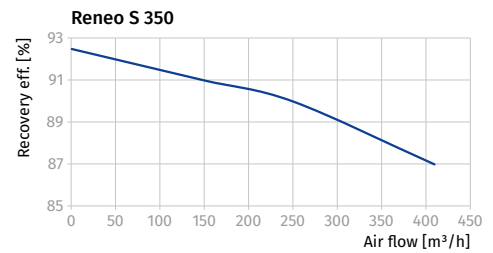
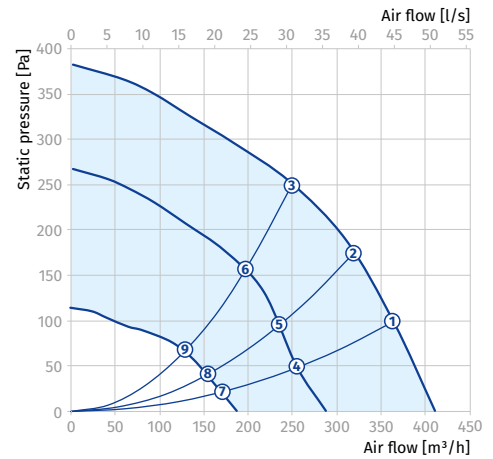











Parameters	Reneo S 350	Reneo S 350-E	Reneo SE 350	Reneo SE 350-E
Voltage [V / 50-60 Hz]	230	230	230	230
Max. unit power without electric heater [W]	210	210	210	210
Integrated electric heater power [W]	-	-	1050	1050
Max. unit power [W]	210	210	1260	1260
Max. unit current without electric heater [A]	1.54	1.54	1.54	1.54
Integrated electric heater current [A]	-	-	4.66	4.66
Max. unit current [A]	1.54	1.54	6.2	6.2
Max. air flow [m <sup>3</sup> /h]	410	410	410	410
Sound pressure level at 3 m distance [dBA]	27	27	27	27
Max. operating temperature [°C]	45	45	45	45
Case material	EPP	EPP	EPP	EPP
Insulation	45 mm	45 mm	45 mm	45 mm
Extract filter	Coarse >60 %	Coarse >60 %	Coarse >60 %	Coarse >60 %
Supply filters	Coarse >60 % (option: ePM1 60 %)	Coarse >60 % (option: ePM1 60 %)	Coarse >60 % (option: ePM1 60 %)	Coarse >60 % (option: ePM1 60 %)
Connected air duct diameter [mm]	160	160	160	160
Weight [kg]	26	26	26	26
Heat recovery efficiency [%]	92	83	92	83
Heat exchanger type	Counter-flow	Counter-flow	Counter-flow	Counter-flow
Heat exchanger material	Polysterene	Enthalpy membrane	Polysterene	Enthalpy membrane
SEC class	A+	A	A+	A

















Sound power level, A-weighted	Total	Octave frequency band [Hz]								LpA 3 m	LpA 1 m
		63	125	250	500	1000	2000	4000	8000		
<b>Point 1</b>											
L <sub>WA</sub> to environment [dBA]	55	34	42	41	46	45	40	37	34	35	44
<b>Point 4</b>											
L <sub>WA</sub> to environment [dBA]	47	24	32	31	36	40	30	27	25	27	36



EPP HEAT AND ENERGY RECOVERY AIR HANDLING UNITS

**Accessories**

		Reneo S 350(-E) S21	Reneo SE 350(-E) S21	Reneo S 350(-E) S14
G4 panel filter		FP 496x150x60 Coarse 90% G4	FP 496x150x60 Coarse 90% G4	FP 496x150x60 Coarse 90% G4
F7 panel filter		FP 496x150x60 ePM1 65% F7	FP 496x150x60 ePM1 65% F7	FP 496x150x60 ePM1 65% F7
Decorative panel		-	-	-
LCD control panel		S25	S25	-
Control panel		S22	S22	-
Wireless control panel		S22 Wi-Fi	S22 Wi-Fi	-
Internal humidity sensor		FS2	FS2	FS2
Internal CO <sub>2</sub> sensor		CD-3	CD-3	CD-3
CO <sub>2</sub> sensor with indication		CD-1	CD-1	CD-1
CO <sub>2</sub> sensor		CD-2	CD-2	CD-2
Humidity sensor		HR-S	HR-S	HR-S
Electric preheater		EVH 160 S21 V.2	-	-
Electric reheater		ENH 160 S21 V.2	ENH 160 S21 V.2	-
Syphon kit (for the units without an enthalpy heat exchanger)		SFK 20x32	SFK 20x32	SFK 20x32
Silencer		SD 160	SD 160	SD 160
Air damper		VKA 160	VKA 160	VKA 160
Electric actuator		TF230	TF230	TF230

		Reneo S 351(-E) S21	Reneo SE 351(-E) S21	Reneo S 351(-E) S14
G4 panel filter		FP 496x150x60 Coarse 90% G4	FP 496x150x60 Coarse 90% G4	FP 496x150x60 Coarse 90% G4
F7 panel filter		FP 496x150x60 ePM1 65% F7	FP 496x150x60 ePM1 65% F7	FP 496x150x60 ePM1 65% F7
Decorative panel		EP-Reneo S 351	EP-Reneo S 351	EP-Reneo S 351
LCD control panel		S25	S25	-
Control panel		S22	S22	-
Wireless control panel		S22 Wi-Fi	S22 Wi-Fi	-
Internal humidity sensor		FS2	FS2	FS2
Internal CO <sub>2</sub> sensor		CD-3	CD-3	CD-3
CO <sub>2</sub> sensor with indication		CD-1	CD-1	CD-1
CO <sub>2</sub> sensor		CD-2	CD-2	CD-2
Humidity sensor		HR-S	HR-S	HR-S
Electric preheater		EVH 160 S21 V.2	-	-
Electric reheater		ENH 160 S21 V.2	ENH 160 S21 V.2	-
Syphon kit (for the units without an enthalpy heat exchanger)		SFK 20x32	SFK 20x32	SFK 20x32
Silencer		SD 160	SD 160	SD 160
Air damper		VKA 160	VKA 160	VKA 160
Electric actuator		TF230	TF230	TF230