

CONTROL PANEL



S16

EN OPERATION MANUAL

CONTENTS

Safety requirements	2
Purpose	4
Delivery set	4
Technical data	4
Mounting and connection	5
Unit control	7
Storage and transportation regulations	13
Manufacturer's Warranty	14
Acceptance certificate	15
Seller's information	15
Installation certificate	15
Warranty card	15

This User's Manual consisting of the technical details, operating instructions and technical specification covers the installation, connection and mounting of S16 control panel (hereinafter „Control panel“ or „Unit“ as mentioned in the „Safety requirements“ and „Manufacturer's warranty“ sections as well as in warnings and information blocks).

SAFETY REQUIREMENTS

Read the user's manual carefully prior to installing and operating the unit.
 Fulfil the user's manual requirements as well as the provisions of all the applicable local and national construction, electrical and technical norms and standards.
 The warnings contained in the user's manual must be considered most seriously since they contain vital personal safety information. Failure to follow the rules and safety precautions noted in this user's manual may result in an injury or unit damage.
 After a careful reading of the manual, keep it for the entire service life of the unit.
 While transferring the unit control the User's manual must be turned over to the receiving operator.

Symbol legend:



NOTICE

WARNING

UNIT MOUNTING AND OPERATION SAFETY PRECAUTIONS



- Disconnect the unit from power mains prior to any installation operations.



- Unpack the unit with care.



- Do not lay the power cable of the unit in close proximity to heating equipment.



- While installing the unit follow the safety regulations specific to the use of electric tools.

UNIT MOUNTING AND OPERATION SAFETY PRECAUTIONS

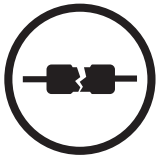

- Do not use damaged equipment or cables when connecting the unit to power mains.



- Do not operate the unit outside the temperature range stated in the user's manual.
- Do not operate the unit in aggressive or explosive environments.



- Do not touch the unit controls with wet hands.
- Do not carry out the installation and maintenance operations with wet hands.

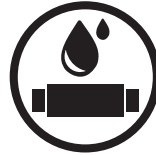

- Do not wash the unit with water.
- Protect the electric parts of the unit against ingress of water.



- Do not allow children to operate the unit.



- Disconnect the unit from power mains prior to any technical maintenance.



- Do not store any explosive or highly flammable substances in close proximity to the unit.



- When the unit generates unusual sounds, odour or emits smoke disconnect it from power supply and contact the Seller.



THE PRODUCT MUST BE COLLECTED SEPARATELY AT THE END OF SERVICE LIFE.

DO NOT DISPOSE OF AS UNSORTED MUNICIPAL WASTE.

PURPOSE

S16 control panel is designed for combined operation with automatic system controllers of MPA and VPA supply ventilation units as well as VUT air handling units with integrated electric heaters.



THE UNIT MAY NOT BE OPERATED BY CHILDREN OR PERSONS WITH REDUCED PHYSICAL, MENTAL OR SENSORY CAPACITIES, OR LACKING THE APPROPRIATE TRAINING.

THE UNIT MUST BE INSTALLED AND CONNECTED ONLY BY PROPERLY QUALIFIED PERSONNEL AFTER THE APPROPRIATE BRIEFING.

THE CHOICE OF UNIT INSTALLATION LOCATION MUST PREVENT UNAUTHORIZED ACCESS BY UNATTENDED CHILDREN.

DELIVERY SET

Control panel	1 piece
User's Manual	1 piece
Box	1 piece

TECHNICAL DATA

Parameter	Value
Ambient temperature, [°C]	From +5 to +40
Relative humidity, [%]	From 5 to 80 (no condensation)
Cable cross-section, [mm ²]	0.25
Casing material	Plastic
Dimensions (WxHxD), [mm]	130x86x30
IP code	IP20

MOUNTING AND CONNECTION



DO NOT LAY THE AIR HANDLING UNIT POWER CABLE IN CLOSE PROXIMITY TO THE CONTROL PANEL SIGNAL CABLE! WHILE ROUTING THE CONTROL PANEL CABLE DO NOT COIL THE EXTRA LENGTH.

The control panel connects to the air handling unit via a four-core Unitronic LiYY cable 0.25 mm² in cross-section. The cable is pre-wired to the air handling unit and the panel terminal block at the factory. Make sure to memorize the positions and the colours of the wires connected to the terminal block to restore the original configuration upon re-installing the panel. The cable colours are given on the terminal block label:

+ Yellow;
B Green;
A Brown;
┘ White.

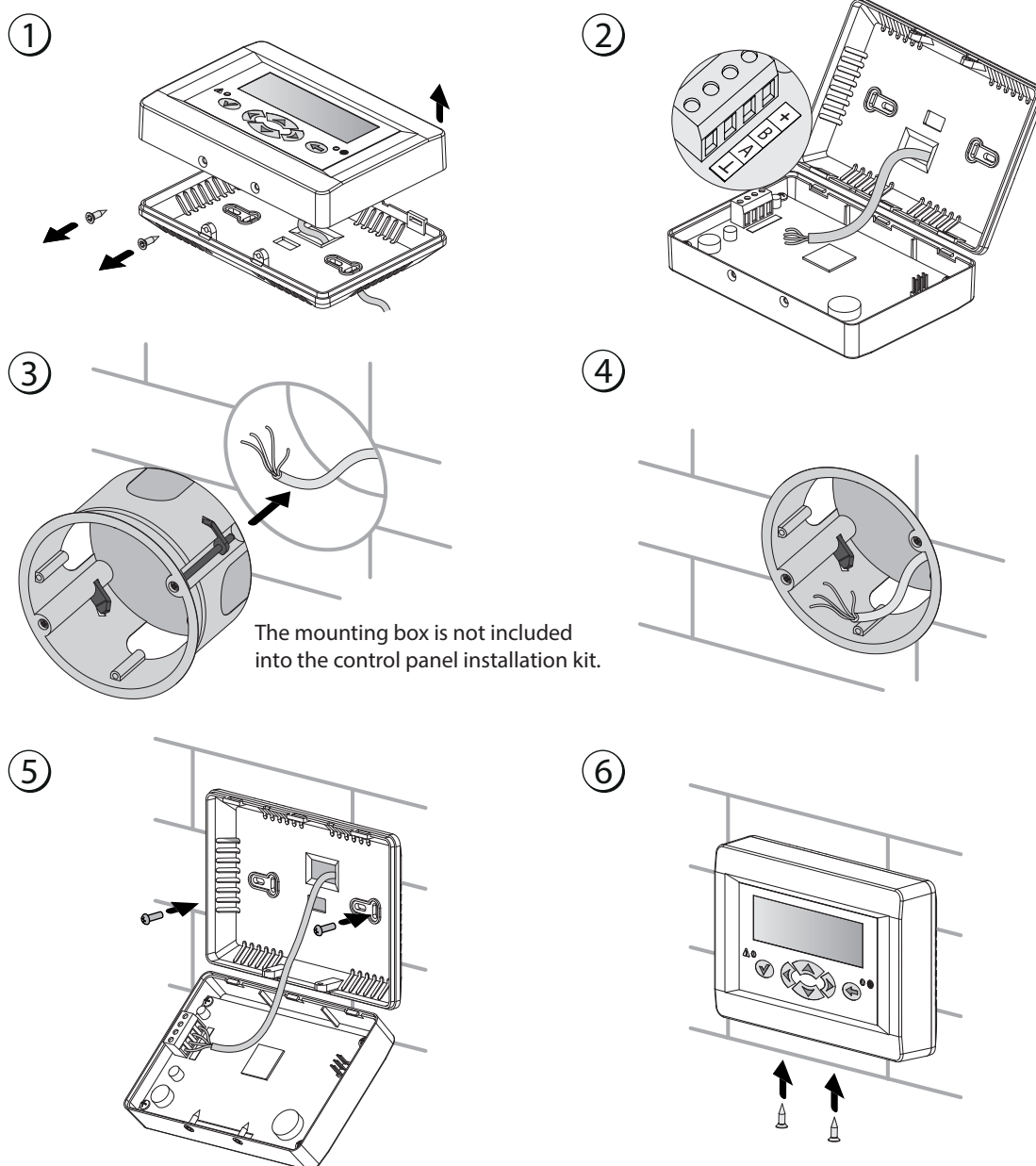
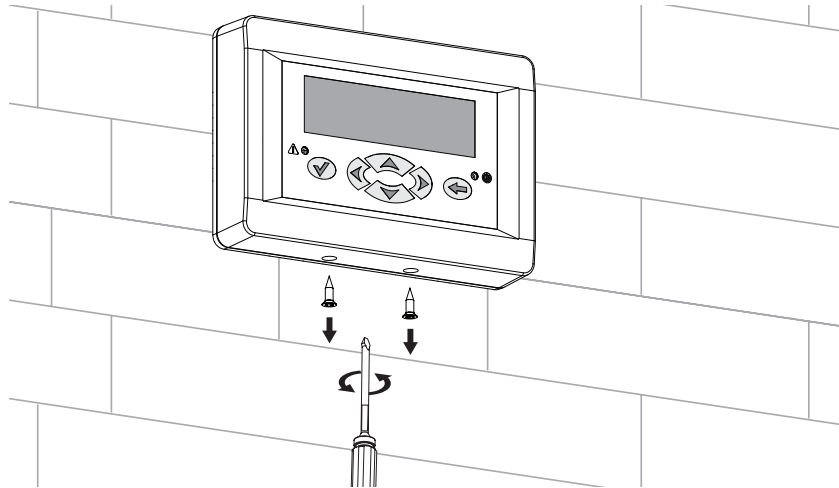

Fig. 1

BATTERY REPLACEMENT

The battery supports the operation of the clock built into the control panel in the event that the air handling unit goes offline due to a power outage. When the battery discharges completely while the unit is offline the clock stops and the date and time settings are reset leading to incorrect date and time readings upon a subsequent power-up of the unit and, as a result, incorrect scheduled operation. To prevent this make sure that the battery is in good condition. Use only fresh batteries for replacement.

- 1 Disconnect the unit from power supply.
- 2 Undo two self-tapping screws in the bottom part of the casing.



- 3 Pull the top part of the casing aside to facilitate access to the circuit board. Replace the battery.
The control panel uses a CR1220 lithium battery.

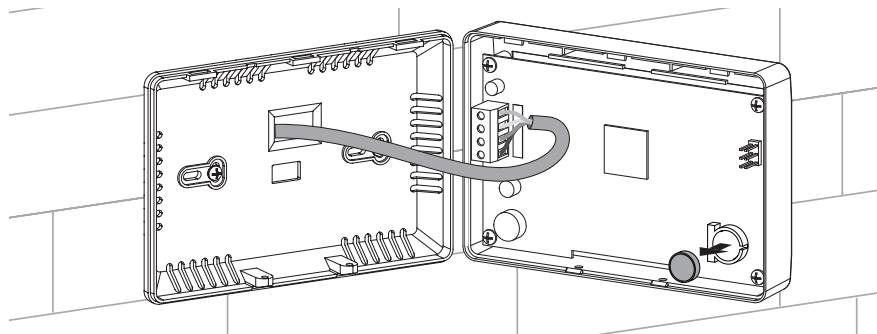

- 4 Re-assemble the control panel in the reverse order.
- 5 Connect the unit to the electric mains and set the control panel date and time.

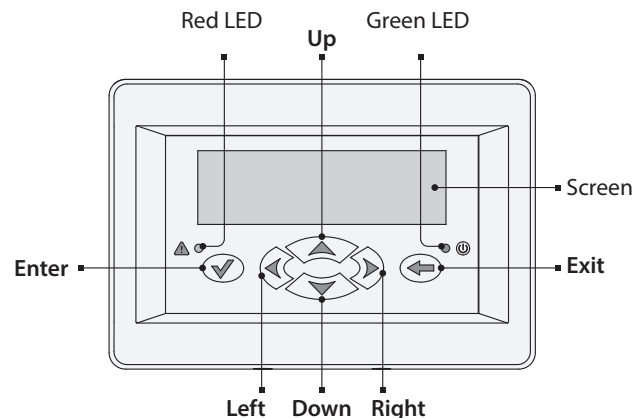

Fig. 2 Control panel button functions

The control panel screen displays the information about the current state of the ventilation system automatic control system. The screen interface is divided into several main windows. Use the **Right/Left** buttons to navigate between the windows. To enter the functions menu press **Enter**. To return to the language menu press **Exit**.

Upon connecting the air handling unit to the electric mains and automatic cut-out switch activation the control panel screen displays the manufacturer's logo. If the „Restart“ function has been enabled (see p. 10.1) the air handling unit switches on automatically in a few seconds. If the „Restart“ function is disabled, press the **Up** or **Down** button to select the air handling unit status.



To save the selected status select „Off“ and press **Enter**. The light goes off and the air handling unit remains disabled. To enable the air handling unit select „On“ in the window and press **Enter**. The air handling unit activates, the green LED indicator lights up, and the screen displays the main window with the current information (see Fig. 3).

The air temperature can be regulated in two ways:

- using the supply air duct temperature sensor;
- using the room air temperature sensor built into the control panel.

The main windows display the following information:

Window 1 (see Fig. 3) – temperature regulation using the supply duct air temperature sensor:

- „a“ – current temperature in the supply duct;
- „b“ – pre-set supply duct temperature value (SETPOINT);
- „c“ – current fan speed;
- „d“ – current heater output;
- „e“ – current operation mode of the air handling unit;
- „f“ – current time.

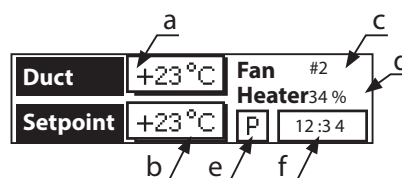

Fig. 3

The air handling unit operation mode (field „e“) has three possible values:

- „M“ – the manual mode. Any adjustments to the parameter values such as air flow rate, heating temperature as well as air handling unit activation or deactivation can only be made by the user. The daily timer and weekly schedules are disabled.
- „D“ – daily timer enabled. The air handling unit is enabled or disabled according to the pre-programmed temperature, air flow rate and daily operation schedule. However, this mode also allows to enable or disable the air handling unit manually.
- „W“ – weekly schedule enabled. The air handling unit is enabled or disabled according to the pre-programmed temperature, air flow rate and weekly operation schedule. However, this mode also allows to enable or disable the air handling unit manually.

To enable temperature regulation using the room air temperature sensor press the **Up** or **Down** button. Main Window 1 displays the information given on Fig. 4.

Room	+23 °C	Fan #2
Set	+23 °C	Heater 34 %
		P 12:34

Fig. 4

Window 2, see Fig. 5:

To switch to Window 2 press the **Right** button.

„h“ – temperature regulation using the outdoor air temperature sensor;

„i“ – temperature regulation using the exhaust air temperature sensor downstream of the heat exchanger.

Outdoor	+12 °C	Fan #2
Exhaust	** °C	Heater 34 %
		P 12:34

Fig. 5

The outdoor air temperature and the exhaust air temperature sensors are not available in some air handling unit modifications. In that case the missing sensors are marked with the „**“ symbol (see Fig. 6).

Outdoor	+12 °C	Fan #2
Exhaust	** °C	Heater 34 %
		P 12:34

Fig. 6

To return to main Window 1 press the **Left** button.

Window 3:

To switch to Window 3 press the **Left** button.

Window 3 displays the list of possible alarms. The „+“ symbol corresponds to an alarm presence while the „-“ symbol – to its absence. In the event of an alarm the red LED goes on and the screen displays the corresponding alarm symbol. Upon the sound alarm activation the warning signal will continue until the air handling unit is powered off or sound alarm is disabled.

Alarm signals:

„**Pressostat**“. This signal is activated by the differential pressure sensor (pressure relay) installed on the air handling unit air filter. This is the signal to replace the air filter.

„**Heater overheating**“. This signal warns about abnormally high air temperature in the electric heater chamber. The signal circuit includes normally closed contacts of thermal cut-out switches installed in the electric heater chamber and the series-connected control coil of the electromagnetic contactor used for emergency opening of the heater supply circuits. This signal means that the air supply to the heater is insufficient.

„**Communication loss**“. This signal is triggered by an interruption of data exchange between the control panel and the air handling unit controller. This may result from a bad contact of the four-core cable connecting the control panel and the air handling unit.

Furthermore, in case of an emergency in addition to generating this alarm signal the automatic control system switches the fans to heater cooling mode and stops the fan motors on elapse of the set time period.

Functions menu:











To enter the functions menu from main Window 1 press the **Enter** button.

Move the cursor and select the respective icon in the functions menu to access the controller functions (see Fig. 7). Use the **Right/Left** buttons to navigate. To change the current parameter setting use the **Up/Down** buttons. To enter the current function settings menu press **Enter** or press **Exit** to cancel or move up a level.



Fig. 7

List of functions menu icons and their meaning:

- | | | | |
|--|---|---|---|
|  | Air handling unit activation/deactivation |  | Filter replacement interval setup |
|  | Speed (air capacity) setup |  | Screen illumination control |
|  | Control temperature selection |  | Emergency sound alarm activation/deactivation |
|  | Date and time setup |  | Indicator contrast setup |
|  | Daily timer setup |  | Service settings |
|  | Weekly schedule setup | | |

1. Unit activation/deactivation.

Unit activation options:

Immediate turning OFF

Upon pressing the **Enter** button the air handling unit is disabled after heater cooling within 120 seconds.

Immediate turning OFF
Turn OFF delay
Temporary shutdown

Turn OFF delay

Upon pressing the **Enter** button the user is prompted to enter the air handling unit deactivation delay.

In this example upon entering the delay value and pressing the **Enter** button the air handling unit will switch off after 20 minutes.

Deactivation in:
00 hours 20 minutes

Temporary shutdown

Upon pressing the **Enter** button the user is prompted to enter the temporary deactivation time. On elapsing the air handling unit switches on automatically and continues to operate using the parameters in place before the temporary deactivation.

In this example upon the time selection and pressing the Enter button the air handling unit will switch off after heater cooling within 120 seconds and re-activate in 90 minutes.

Deactivation in:
01 hours 30 minutes

2. Speed (air capacity) setup.

The user is prompted to select one of the three fan speed stages using the **Up/Down** buttons.

3. Control temperature (setpoint) setup.

Use the **Up/Down** buttons to set the control temperature (air temperature in the supply duct or in the serviced space) within the +10 – + 40 °C range. There is also the „***“ heater forced shutdown mode. If the heater is disabled, supply air heating is not available.

4. Date/time setup. Calendar setup.

Year	12	Day	MO
Date	12	Hours	12
Day	31	Minutes	34

Use the **Up/Down** and **Left/Right** buttons to move the cursor to the necessary field, then press the **Enter** button and change the item value using the **Up/Down** buttons.

Year	12	Day	MO
Month	12	Hours	11
Date	31	Minutes	34

Press the **Enter** button once again to go back to the functions menu. To exit the functions menu press the **Exit** button.

5. Daily timer setup.

The daily timer activates and deactivates the air handling unit at the pre-programmed period of time on a daily basis.

Daily timer
Activate
Deactivate

Upon selecting „Daily timer- On“ set the unit activation and deactivation time.

Turn ON time:	Turn OFF time:
12:12	21:34

Use the **Left/Right** buttons to move the cursor to the necessary field. Then use the Up/Down buttons to change the timer value. Press the Enter button to return to the functions menu and save the new settings. In the example above the air handling unit will deactivate at 21:34 and activate at 12:12.

Once the daily timer has been enabled the main window shows „D“ („Daily timer enabled“) in the „Operation mode“ field.

Attention! The weekly schedule has priority over the daily timer. If the daily timer and the weekly schedule are used simultaneously the main window shows „W“ („Weekly schedule enabled“) in the „Operation mode“ field of the main window.

6. Weekly schedule setup.

The weekly schedule is used to automatically maintain the pre-programmed temperature and fan speed at a certain time of a certain day of the week as well as to enable and disable the air handling unit at a certain time automatically. Unlike the daily timer the weekly schedule items trigger when the current time matches the programmed value (not during the pre-programmed period of time). The user can set up to 15 programs for each day of the week. Upon the weekly schedule activation the main window shows „W“ „Weekly schedule enabled“ in the „Operation mode“ field. Although the weekly schedule and the daily timer can be used simultaneously, the weekly schedule has priority over the daily timer. When used simultaneously the main window shows „W“ in the „Operation mode“ field.

To set up the weekly schedule use the operation mode menu:

Activate
Deactivate
Review

6.1 „Activate“ – enabling the weekly schedule. Press the Enter button to enable the weekly schedule and review the current settings.

Up/Down: change the current position of the day of the week or program number of the chosen day (depending on the cursor position).

MONDAY	N:01
⚙️ #3	t↓ 23°C 12:34

Left/Right: use the cursor to select „Day of the week“ or „Program number“ field for the current day of the week.

MONDAY	N:01
⚙️ #3	t↓ 23°C 12:34

In this example program #01 includes the following actions for MONDAY: switch the fan speed to stage 3 and set the control temperature to +23 °C at 12:34. Moving one step up produces the following readings:

MONDAY	N:02
⚙️ #1	t↓ 20°C 22:30

This means that according to Program #2 the control temperature setting will be reduced to +20 °C and the fan speed will be set to speed stage 1 at 22:30.

6.2 „**Deactivate**“ – disabling the weekly schedule and exit to the functions menu.

6.3 „**Review**“ – settings preview in the read-only mode;

6.4 „**Edit**“ – weekly schedule program editing mode. This mode allows editing the air temperature and fan performance settings, adding and deleting programs for specific days of the week as well as editing the values entered previously.

Weekly schedule setup:

Use the **Up/Down** buttons to select the day of the week (for example, MONDAY). Program number „# 00“ means that there aren't any programs created for the given day.



Having selected the day of the week press **Enter** to move to the next program selection position. The rest of the settings such as air capacity, air temperature and time are completed automatically using the current parameters.



In this example the following actions are set for Program #01 for MONDAY: switch fan speed to stage 3 and set the control temperature to +23 °C at 12:34. Press the **Enter** button to switch to Program #01 parameter editing window.



Use the **Left/Right** buttons to select the parameter position and then use the **Up/Down** buttons to set the parameter value. In this example the cursor is currently at the clock field. To set the time for Program #01 activation use the **Up/Down** buttons.



To complete the program setup (in this case it is Program #01 for Monday) press the **Enter** button.



To switch to the following program press the **Enter** button.



In this example Program #02 has been added. This way more programs can be added for the selected day of the week. As shown in Program #02 example, set the control temperature to +25 °C. To do this press the **Enter** button while the cursor is at Program #02, enter the editing window, set the cursor to the temperature field and enter „25“ using the **Up/Down** buttons.



Then press **Enter**.



Program #02 has been entered into the memory.

The weekly schedule settings enable forced heater shutdown. Enter Program #01 by pressing the **Left** or **Right** button, and then press the **Up** or **Down** button.



To enter Program #01 editing mode press the **Enter** button:



Use the **Up/Down** buttons to set the desired temperature „**“:



To finish editing the parameters press **Enter**.



In this example air heating option is disabled for program shown.

To program the air handling unit to shut down enter the „**“ value into the speed selection field using the **Up/Down** buttons. The temperature value will set to „**“ automatically. This will cause the air handling unit to shut down at the pre-programmed time.



To edit or delete a program from the list for a given day of the week press the **Left** or **Right** button to move the cursor to the desired program number and select the program number to edit or delete by pressing the **Up** or **Down** buttons. To proceed with editing press **Enter** to switch to the editing window. Press **Enter** to delete the selected number program. Upon deleting the cursor will return to the day of the week selection position, the program will be deleted from the memory and its number will be assigned to the next program in the sequence causing all the remaining programs to shift one level down on the list.

Example of deleting Program #01:

While in the day of the week selection menu (in this case **MONDAY**) move the cursor to Program #01:
Select Program #02 in the „**MONDAY**“ position:



Press the **Left** or **Right** button. Switch to the program selection menu:



Select Program #01 by pressing the **Up** or **Down** buttons:



Press the **Exit** button:



The values entered into Program #02 (speed stage 3, control temperature +25 °C, and program activation time 12:34) have shifted one number down while Program #01 values have been permanently deleted from the list. In other words, Program #02 parameters have replaced those of Program #01. This method allows deleting programs made in error. Press **Exit** to return to the weekly schedule mode selection menu.

6.5 „**Reset**“ – deleting all the previously made programs for all days of the week from the memory.

7. Filter replacement interval setup.

The filter replacement interval can be programmed in the 10–99 days. Upon elapsing of the period the main window of the control panel screen is replaced with the following message:



This message only serves as a filter replacement warning and does not affect the air handling unit operation. The machine hours counter is enabled only during the air handling unit operation and remains disabled while the unit is off.

To clear the message press **Enter** which takes to the Functions mode. After returning to the main window the warning message replaces the main window again. To disable the warning message go to the Functions mode, select the „Filter replacement interval setup“ icon and set the new value by using the **Up/Down** buttons.

8. LED backlight activation/deactivation.

The LED screen backlight can be enabled or disabled. When enabled the light remains always on. When the „Auto“ mode is selected the screen lights up for two minutes after the last press of any button.

9. Sound signal activation/deactivation.

The sound signal accompanies any changes made to the unit settings and provides the air handling unit emergency warning. In case of an emergency (while the sound signal is enabled) the sound alarm will signal an emergency situation until reset.

10. Engineering settings.

Air handling unit equipment parameter list. By default the service settings menu is password-protected (see p. 10.5).

10.1 „**Restart after power failure**“. This parameter enables the air handling unit reactivation after a power failure. In the event of a power failure (unit shutdown with a subsequent restart) the air handling unit remains disabled if restart is disabled. If restart is enabled the air handling unit returns to the previous mode (disabled or enabled) and continue to follow the daily timer and weekly schedule program. Format: 1 – enable, 0 – disable. Default value: 1.

10.2 „**t° heat exch. freeze protect.**“ - the outdoor air temperature threshold for engaging the heat exchanger freeze protection sequence which involves the bypass damper position adjustment (while the bypass is in the automatic mode – see p. 10.3). Range: -10 – +10 °C. Default value: 0 °C.

10.3 „**Bypass mode**“ – „**Open**“ / „**Auto**“. While in the „Open“ mode the bypass damper is permanently open. In the „Auto“ mode the bypass damper remains closed until the outdoor air temperature drops below the threshold value set by the „**t° heat exchanger freeze protection**“ parameter (see p. 10.2) in which case the damper will cyclically open for 5 minutes and close for 25 minutes. Format: 0 = Open, 1 = Auto. Default value: 1.

10.4 „**Data exch. protocol**“ is used for ensuring compatibility with other automatic control systems. The default value is „1“.

10.5 „**Change password**“ enables changing the current password used for entering the Engineering Menu. To disable the password enter 0000. Range: 0000–9999. Default value: 1111.

10.6 „**Default settings**“ enables resetting all the settings to the factory values (set by default).

10.7 „**Sensor correction**“ enables correction of the built-in temperature sensor. Value range: ±9 °C. Default value: 0 °C.

STORAGE AND TRANSPORTATION REGULATIONS

Store the unit in the manufacturer's original packing box in a dry ventilated premise at ambient temperatures from +5 °C to +40 °C. Storage environment must not contain aggressive vapours and chemical mixtures provoking corrosion, insulation and sealing deformation.

Use suitable hoist machinery for handling and storage operations to prevent possible damage to the unit.

Follow the handling requirements applicable for the particular type of cargo.

The unit can be carried in the original packing by any mode of transport provided proper protection against precipitation and mechanical damage.

Avoid sharp blows, scratches or rough handling during loading and unloading.

Do not subject the unit to rapid changes of temperature. A rapid change of temperature may result in moisture condensation inside the unit with a potential adverse effects on its operation upon power-up. After transporting or storing the unit at subzero temperatures the unit should be kept under operating conditions for at least 2 hours before power-up.

MANUFACTURER'S WARRANTY

The warranty period is 24 months after the retail sale date provided the user's observance of the transportation, storage, mounting and operation regulations.

Should any malfunctions occur in the course of the unit operation through the Manufacturer's fault during the guaranteed period of operation the user is entitled to elimination of faults by the manufacturer by means of warranty repair at the factory free of charge.

The warranty repair shall include work specific to elimination of faults in the unit operation to ensure its intended use by the user within the guaranteed period of operation. The faults are eliminated by means of replacement or repair of the unit components or a specific part of such unit component.

The warranty repair does not include:

- Routine technical maintenance;
- Unit installation / dismantling;
- Unit setup.

To benefit from warranty repair the user must provide the unit, the user's manual with the purchase date stamp and the payment document certifying the purchase.

The unit model must comply with the one stated in the user's manual.

Contact the Seller for warranty service.

The manufacturer's warranty does not apply to the following cases:

- User's failure to submit the unit with the entire delivery package as stated in the user's manual including submission with missing component parts previously dismantled by the user.
- Mismatch of the unit model and the brand name with the information stated on the unit packing and in the user's manual.
- User's failure to ensure timely technical maintenance of the unit.
- External damage to the unit casing (excluding external modifications as required for installation) and internal components caused by the user.
- Redesign or engineering changes to the unit.
- Replacement and use of any assemblies, parts and components not approved by the manufacturer.
- Unit misuse.
- User's violation of the unit installation regulations.
- User's violation of the unit control regulations.
- Unit connection to the power mains with a voltage different from the one stated in the user's manual.
- Unit breakdown due to voltage surges in the power mains.
- Discretionary repair of the unit by the user.
- Unit repair by any persons without the manufacturer's authorization.
- Expiration of the unit warranty period.
- User's violation of the unit transportation regulations.
- User's violation of the unit storage regulations.
- Wrongful actions against the unit committed by third parties.
- Unit breakdown due to circumstances of insuperable force (fire, flood, earthquake, war, hostilities of any kind, blockades).
- Missing seals if provided by the user's manual.
- Failure to submit the user's manual with the unit purchase date stamp.
- Missing payment document certifying the unit purchase.



FOLLOWING THE REGULATIONS STIPULATED HEREIN WILL ENSURE A LONG AND TROUBLE-FREE OPERATION OF THE UNIT.



USERS' WARRANTY CLAIMS SHALL BE SUBJECT TO REVIEW ONLY UPON PRESENTATION OF THE UNIT, THE PAYMENT DOCUMENT AND THE USER'S MANUAL WITH THE PURCHASE DATE STAMP.

ACCEPTANCE CERTIFICATE

Control panel

S16

is recognized as serviceable.

The unit complies with the requirements according to the EU norms and directives, to the relevant EU-Low Voltage Equipment Directives, EU-Directives on Electromagnetic Compatibility.
We hereby declare that the unit complies with the essential protection requirements of Electromagnetic Council Directive 2004/108/EC, 89/336/EEC and Low Voltage Directive 2006/95/EC, 73/23/EEC and CE-marking Directive 93/68/EEC on the approximation of the laws of the Member States relating to electromagnetic compatibility, which relate to electrical appliances used in set voltage classes.
This certificate is issued following test carried out on samples of the product referred to above.

Quality Inspector's Stamp Manufacture Date _____

CONNECTION CERTIFICATE

Control panel

S16

is connected to power mains in compliance with the operation manual requirements by the professional:

Company: _____

Expert's Full Name _____

Date _____ Signature _____

WARRANTY CARD

S16

SELLER _____

PURCHASE DATE _____

REPRESENTATIVE IN EU _____

BLAUBERG Ventilatoren GmbH
Aidenbachstr. 52
D-81379 Munich, Germany



BLAUBERG
Ventilatoren

