

S-Vent

Centrifugal inline fans

Use

- Extract ventilation systems installed in various premises.
- Suitable for use as a component of an assembled air handling or conditioning unit.
- Compatible with Ø 140 up to 500 mm round air ducts or 125x125 up to 800x800 mm rectangular air ducts.



Air flow:
up to 19000 m³/h
5278 l/s



Power:
from 250 W



Noise level:
from 60 dBA



Design

- Scroll casing is made of steel and is covered with a special polymer coating.
- The fan is equipped with a round intake flange and exhaust rectangular flange for connection to respective air ducts.
- The fan casing design provides several impeller rotating positions rightwards (R) or leftwards (L) with 45° pitch angle.
- The casing includes mounting brackets with a mount pad for to facilitate the fan installation to an even surface.

Motor

- Two-, four-, six- or eight-pole three-phase asynchronous motor with centrifugal impeller and forward curved blades.
- Galvanized steel impeller.
- Equipped with ball bearings for longer service life.
- Dynamically balanced impeller.
- IP54 ingress protection rating.

Speed control

- Smooth or step-up speed control with an external auto transformer or frequency inverter (both available upon separate order).

Mounting

- The fan is designed for installation as a single unit or as a component unit of ventilation chambers or air conditioning units.
- The fan has a connection possibility for two air ducts, a rectangular discharge air duct through the flange on the casing as well as a round intake air duct through the connecting flange **FRZ-SV**. Available upon separate order.
- In case of rectangular discharge air duct connection a discharge vent must be covered with the **SG-SV** grille to protect the fan from foreign object ingress. Available upon separate order.
- The vibration isolators, either of rubber type **SI-G** or spring-loaded type **SI-F**, are recommended for noise and vibration attenuation. Vibration isolators reduce dynamic loads on the fan, enhance reliability and durability of the ventilation equipment. The vibration isolators are attached through holes in the mounting pad. Available upon separate order.

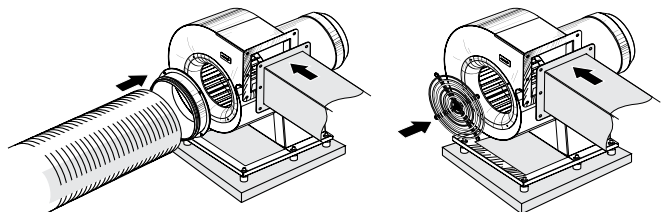

SI-G



SI-F

Designation key

Series	Impeller diameter and width [mm]	Motor power [kW]	Number of poles	Phase	Casing modification	Spiral casing pitch angle
S-Vent	140x74; 160x74; 180x74; 200x93; 225x103; 240x114; 250x127; 280x127; 315x143; 355x143; 400x183; 450x203; 500x229	- 0.25; 0.37; 0.55; 0.75; 1.1; 1.5; 2.2; 3; 4; 5.5; 7.5; 11	- 2; 4; 6; 8	E: single-phase D: three-phase	R: Right L: Left	0; 45; 90; 135; 180; 225; 270; 315

Accessories

Silencers	Filter boxes	Electric heaters	Water heaters	Backdraft air dampers	Air dampers	Flexible antivibration connectors
SD / SDF	KFBK / KFBT	EKH	WKH	VRV	VK / VKA	EVAF

Overall dimensions [mm]

Type	∅ D	∅ d	∅ D1	B	H	H1	H2	L	L1	L2	P	M	I	G	K	S	Weight [kg]
S-Vent 140x74-0.25-4D	140	8	10	242	323	125	92	309	125	95	124	220	234	18	253	80	9.3
S-Vent 140x74-0.37-2D	140	8	10	242	323	125	92	309	125	95	124	220	234	18	253	80	9.3
S-Vent 160x74-0.55-4D	160	8	10	277	373	134	106	356	134	104	141	220	260	17	252	90	12.7
S-Vent 160x74-0.75-2D	160	8	10	277	373	134	106	356	134	104	141	220	260	17	252	90	13.0
S-Vent 180x74-0.55-4D	180	10	10	311	414	143	120	365	143	114	146	270	270	22	314	90	13.5
S-Vent 180x74-1.1-2D	180	10	10	311	414	143	120	365	143	114	146	270	270	22	314	90	14.5
S-Vent 200x93-0.55-4D	200	10	10	345	436	160	134	380	160	129	158	270	284	24	315	90	15.2
S-Vent 200x93-1.1-2D	200	10	10	345	436	160	134	380	160	129	158	270	284	24	315	90	16.2
S-Vent 225x103-1.1-4D	225	10	12	388	507	178	151	432	172	141	174	275	316	27	330	100	21.2
S-Vent 225x103-2.2-2D	225	10	12	388	507	178	151	432	172	141	174	275	316	27	330	100	24.2
S-Vent 240x114-2.2-4D	240	10	12	414	568	186	161	461	186	156	195	275	362	27	330	125	30.5
S-Vent 240x114-3.0-2D	240	10	12	414	568	186	161	461	186	156	195	275	362	27	330	125	31.4
S-Vent 250x127-1.5-6D	250	10	12	431	594	202	168	473	202	166	206	300	373	27	355	125	33.0
S-Vent 250x127-2.2-4D	250	10	12	431	594	202	168	473	202	166	206	300	373	27	355	125	32.2
S-Vent 250x127-5.5-2D	250	10	12	431	614	202	168	517	202	166	213	300	397	27	355	140	40.0
S-Vent 280x127-1.5-6D	280	10	12	483	626	225	189	503	231	196	243	300	410	27	355	125	35.1
S-Vent 280x127-2.2-4D	280	10	12	483	626	225	189	503	231	196	243	300	410	27	355	125	34.2
S-Vent 280x127-5.5-2D	280	10	12	483	646	225	189	545	231	196	243	300	427	27	355	140	42.4
S-Vent 315x143-2.2-6D	315	10	15	543	731	250	213	568	255	216	268	350	452	27	405	140	46.8
S-Vent 315x143-4.0-4D	315	10	15	543	731	250	213	568	255	216	268	350	452	27	405	140	49.8
S-Vent 355x143-2.2-6D	355	10	15	611	817	275	241	566	255	214	253	350	442	32	405	140	49.0
S-Vent 355x143-4.0-4D	355	10	15	611	817	275	241	566	255	214	253	350	442	32	405	140	51.0
S-Vent 400x183-1.5-8D	400	10	15	689	870	310	272	619	310	268	313	400	497	27	455	140	57.1
S-Vent 400x183-2.2-6D	400	10	15	689	870	310	272	619	310	268	313	400	497	27	455	140	54.1
S-Vent 400x183-5.5-4D	400	10	15	689	882	310	272	662	330	289	341	400	525	27	455	140	69.5
S-Vent 450x203-3.0-8D	450	10	15	774	985	345	306	690	352	315	351	450	550	42	530	140	77.8
S-Vent 450x203-4.0-6D	450	10	15	774	985	345	306	690	352	315	351	450	550	42	530	140	76.5
S-Vent 450x203-11.0-4D	450	10	15	774	1005	345	306	722	352	315	371	450	608	42	530	178	105.0
S-Vent 500x229-5.5-8D	500	11	15	860	1115	390	341	761	401	353	408	500	645	42	580	178	85.0
S-Vent 500x229-7.5-6D	500	11	15	860	1115	390	341	761	401	353	408	500	645	42	580	178	86.0
S-Vent 500x229-11.0-4D	500	11	15	860	1115	390	341	761	401	353	408	500	645	42	580	178	107.0

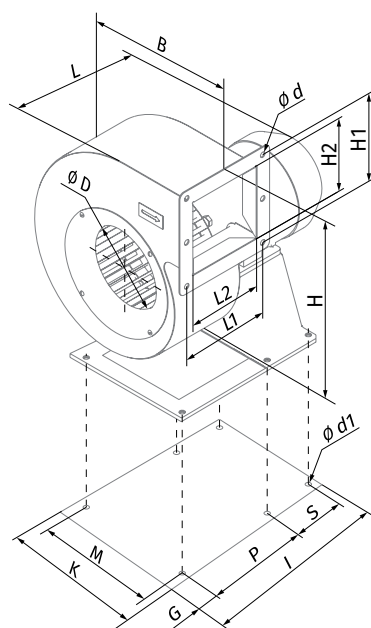

Technical data

Parameters	S-Vent 140x74-0.25-4D	S-Vent 140x74-0.37-2D	S-Vent 160x74-0.55-4D	S-Vent 160x74-0.75-2D	S-Vent 180x74-0.55-4D	S-Vent 180x74-1.1-2D	S-Vent 200x93-0.55-4D	S-Vent 200x93-1.1-2D
Voltage [V]	3 ~ 400	3 ~ 400	3 ~ 400	3 ~ 400	3 ~ 400	3 ~ 400	3 ~ 400	3 ~ 400
Frequency [Hz]	50	50	50	50	50	50	50	50
Power [kW]	0.25	0.37	0.55	0.75	0.55	1.1	0.55	1.1
Current [A]	0.8	0.9	1.6	1.8	1.6	2.6	1.6	2.6
Maximum air flow [m³/h (l/s)]	450 (125)	710 (197)	750 (208)	1540 (428)	1030 (286)	1950 (542)	1615 (449)	1900 (528)
RPM [min ⁻¹]	1350	2730	1360	2820	1360	2800	1360	2800
Sound pressure at 3 m [dBA]	60	65	62	68	64	70	67	73
Max. transported air temperature [°C]	+60	+60	+60	+60	+60	+60	+60	+60
SEC class	D	D	D	-	D	-	-	-
IP rating	IP54	IP54	IP54	IP54	IP54	IP54	IP54	IP54
Motor IP rating	IP54	IP54	IP54	IP54	IP54	IP54	IP54	IP54
ErP	2018	2018	2018	2018	2018	-	-	-

S-VENT 140x74-0.37-2D, S-VENT 140x74-0.25-4D

Sound power level, A-weighted	Total	Octave frequency bands [Hz]							
		63	125	250	500	1000	2000	4000	8000
S-Vent 140x74-0.37-2D									
LWA to environment [dBA]	68	47	59	69	72	74	75	72	71
S-Vent 140x74-0.25-4D									
LWA to environment [dBA]	61	43	58	64	61	68	68	65	63

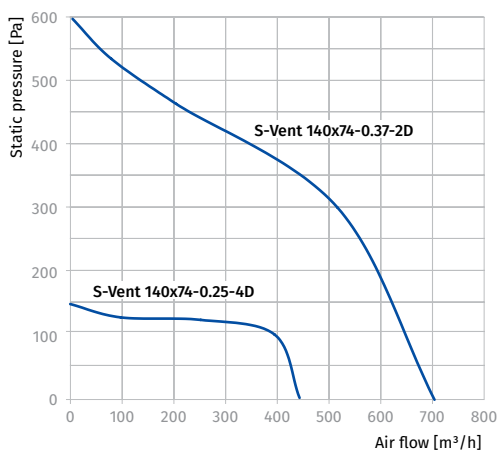
S-VENT 160x74-0.75-2D, S-VENT 160x74-0.55-4D

Sound power level, A-weighted	Total	Octave frequency bands [Hz]							
		63	125	250	500	1000	2000	4000	8000
S-Vent 160x74-0.75-2D									
LWA to environment [dBA]	67	48	60	69	74	74	78	73	72
S-Vent 160x74-0.55-4D									
LWA to environment [dBA]	63	46	59	64	65	69	71	68	65

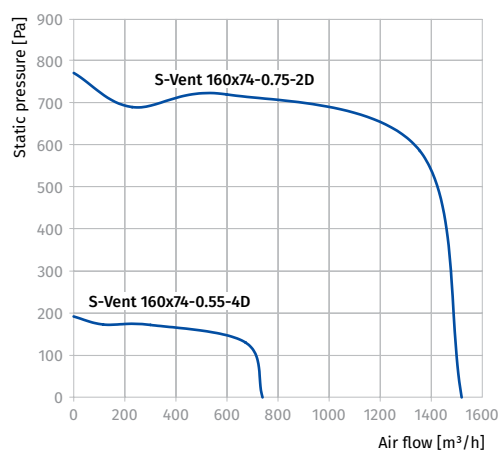
S-VENT 180x74-1.1-2D, S-VENT 180x74-0.55-4D

Sound power level, A-weighted	Total	Octave frequency bands [Hz]							
		63	125	250	500	1000	2000	4000	8000
S-Vent 180x74-1.1-2D									
LWA to environment [dBA]	70	53	62	72	78	77	81	78	77
S-Vent 180x74-0.55-4D									
LWA to environment [dBA]	62	50	63	68	67	73	75	69	67

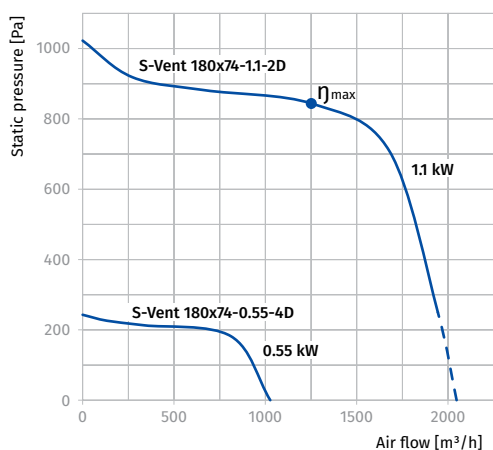
S-VENT 200x93-1.1-2D, S-VENT 200x93-0.55-4D

Sound power level, A-weighted	Total	Octave frequency bands [Hz]							
		63	125	250	500	1000	2000	4000	8000
S-Vent 200x93-1.1-2D									
LWA to environment [dBA]	75	54	65	78	81	81	85	78	78
S-Vent 200x93-0.55-4D									
LWA to environment [dBA]	65	51	64	71	72	75	77	72	70

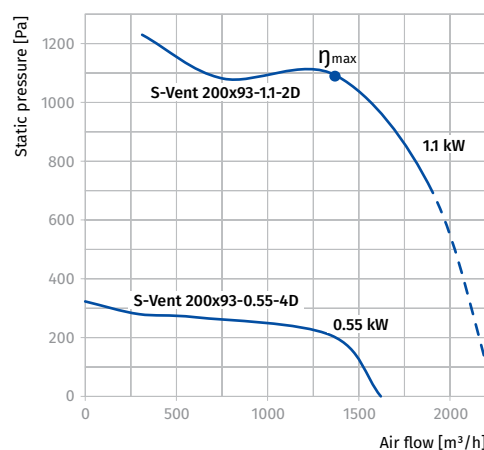

Parameters	S-Vent 225x103-1.1-4D	S-Vent 225x103-2.2-2D	S-Vent 240x114-2.2-4D	S-Vent 240x114-3.0-2D	S-Vent 250x127-1.5-6D	S-Vent 250x127-2.2-4D	S-Vent 250x127-5.5-2D	S-Vent 280x127-1.5-6D
Voltage [V]	3 ~ 400	3 ~ 400	3 ~ 400	3 ~ 400	3 ~ 400	3 ~ 400	3 ~ 400	3 ~ 400
Frequency [Hz]	50	50	50	50	50	50	50	50
Power [kW]	1.1	2.2	2.2	3.0	1.5	2.2	5.5	1.5
Current [A]	2.8	4.7	5.1	6.1	4.2	5.1	10.7	4.2
Maximum air flow [m³/h (l/s)]	2125 (590)	3350 (931)	2930 (814)	4350 (1208)	2415 (671)	3720 (1033)	4820 (1339)	3450 (958)
RPM [min⁻¹]	1420	2865	1420	2870	940	1420	2850	940
Sound pressure at 3 m [dBA]	72	75	74	78	68	78	81	69
Max. transported air temperature [°C]	+60	+60	+60	+60	+60	+60	+60	+60
SEC class	-	-	-	-	-	-	-	-
IP rating	IP54	IP54	IP54	IP54	IP54	IP54	IP54	IP54
Motor IP rating	IP54	IP54	IP54	IP54	IP54	IP54	IP54	IP54
ErP	-	2018	-	-	-	-	-	-

S-VENT 225x103-2.2-2D, S-VENT 225x103-1.1-4D

Sound power level, A-weighted	Total	Octave frequency bands [Hz]							
		63	125	250	500	1000	2000	4000	8000
S-Vent 225x103-2.2-2D									
LWA to environment [dBA]	75	58	67	78	83	83	88	81	79
S-Vent 225x103-1.1-4D									
LWA to environment [dBA]	72	55	65	75	76	81	81	77	75

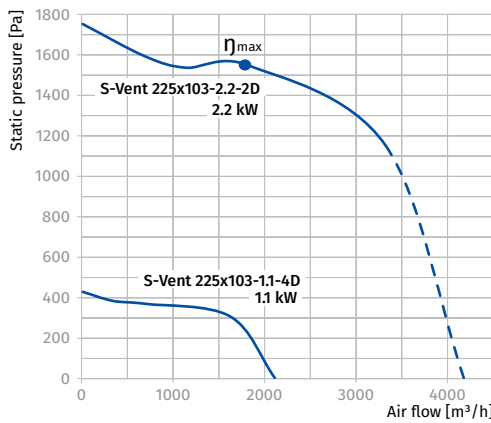

S-VENT 240x114-2.2-4D, S-VENT 240x114-3.0-2D

Sound power level, A-weighted	Total	Octave frequency bands [Hz]							
		63	125	250	500	1000	2000	4000	8000
S-Vent 240x114-2.2-4D									
LWA to environment [dBA]	71	57	69	75	75	81	82	79	76
S-Vent 240x114-3.0-2D									
LWA to environment [dBA]	77	58	69	74	78	73	79	78	78

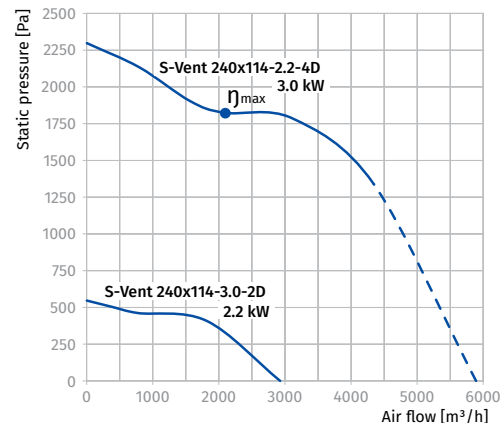

S-VENT 250x127-2.2-4D, S-VENT 250x127-1.5-6D

Sound power level, A-weighted	Total	Octave frequency bands [Hz]							
		63	125	250	500	1000	2000	4000	8000
S-Vent 250x127-2.2-4D									
LWA to environment [dBA]	70	56	71	77	74	81	82	80	73
S-Vent 250x127-1.5-6D									
LWA to environment [dBA]	65	50	62	68	68	73	71	72	65

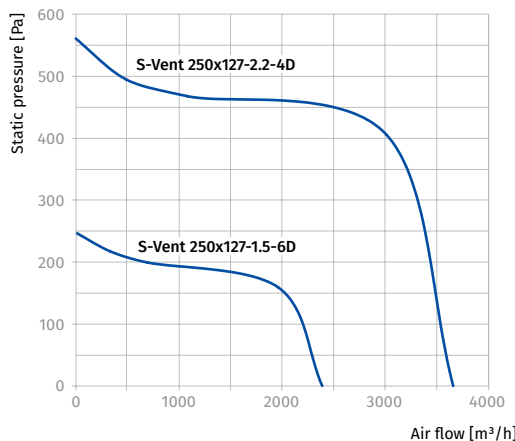

S-VENT 250x127-5.5-2D

Sound power level, A-weighted	Total	Octave frequency bands [Hz]							
		63	125	250	500	1000	2000	4000	8000
LWA to environment [dBA]	78	57	71	79	84	85	89	83	81

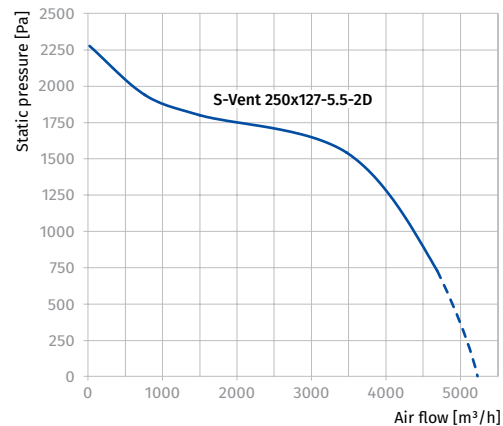

Parameters	S-Vent 280x127-2.2-4D	S-Vent 280x127-5.5-2D	S-Vent 315x143-2.2-6D	S-Vent 315x143-4.0-4D	S-Vent 355x143-2.2-6D	S-Vent 355x143-4.0-4D	S-Vent 400x183-1.5-8D	S-Vent 400x183-2.2-6D
Voltage [V]	3 ~ 400	3 ~ 400	3 ~ 400	3 ~ 400	3 ~ 400	3 ~ 400	3 ~ 400	3 ~ 400
Frequency [Hz]	50	50	50	50	50	50	50	50
Power [kW]	2.2	5.5	2.2	4.0	2.2	4.0	1.5	2.2
Current [A]	5.1	10.7	5.6	8.7	5.6	8.7	4.2	5.8
Maximum air flow [m ³ /h (l/s)]	4395 (1221)	6330 (1758)	4375 (1215)	6530 (1814)	5090 (1414)	8150 (2264)	6545 (1818)	8100 (2250)
RPM [min ⁻¹]	1420	2865	940	1410	940	1410	700	940
Sound pressure at 3 m [dBA]	75	81	70	79	71	79	62	73
Max. transported air temperature [°C]	60	60	60	60	60	60	60	60
SEC class	-	-	-	-	-	-	-	-
IP rating	IP54	IP54	IP54	IP54	IP54	IP54	IP54	IP54
Motor IP rating	IP54	IP54	IP54	IP54	IP54	IP54	IP54	IP54
ErP	-	-	-	-	-	-	-	-

S-VENT 280x127-2.2-4D, S-VENT 280x127-1.5-6D

Sound power level, A-weighted	Total	Octave frequency bands [Hz]							
		63	125	250	500	1000	2000	4000	8000
S-Vent 280x127-2.2-4D									
LWA to environment [dBA]	73	61	74	76	81	82	83	81	77
S-Vent 280x127-1.5-6D									
LWA to environment [dBA]	67	50	63	69	67	73	71	69	66

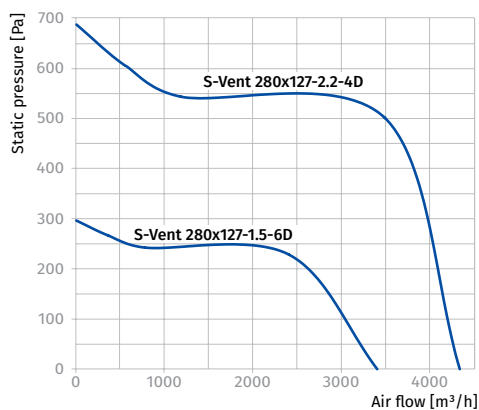
S-VENT 280x127-5.5-2D

Sound power level, A-weighted	Total	Octave frequency bands [Hz]							
		63	125	250	500	1000	2000	4000	8000
LWA to environment [dBA]	80	63	72	81	88	86	91	87	86

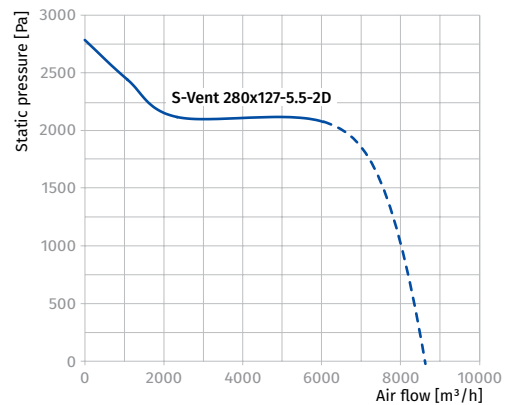
S-VENT 315x143-4.0-4D, S-VENT 315x143-2.2-6D

Sound power level, A-weighted	Total	Octave frequency bands [Hz]							
		63	125	250	500	1000	2000	4000	8000
S-Vent 315x143-4.0-4D									
LWA to environment [dBA]	78	62	73	81	84	88	86	86	83
S-Vent 315x143-2.2-6D									
LWA to environment [dBA]	71	56	67	70	80	78	79	72	68

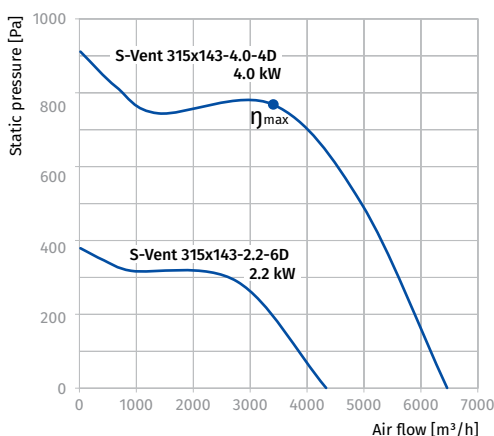
S-VENT 355x143-4.0-4D, S-VENT 355x143-2.2-6D

Sound power level, A-weighted	Total	Octave frequency bands [Hz]							
		63	125	250	500	1000	2000	4000	8000
S-Vent 355x143-4.0-4D									
LWA to environment [dBA]	77	62	75	80	84	87	90	82	82
S-Vent 355x143-2.2-6D									
LWA to environment [dBA]	71	54	68	73	82	82	82	75	72

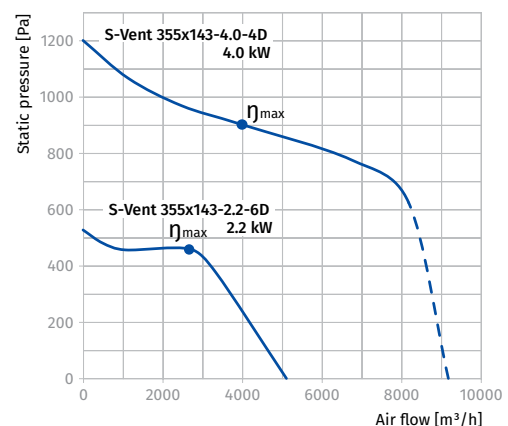

Parameters	S-Vent 400x183-5.5-4D	S-Vent 450x203-3.0-8D	S-Vent 450x203-4.0-6D	S-Vent 450x203-11.0-4D	S-Vent 500x229-5.5-8D	S-Vent 500x229-7.5-6D	S-Vent 500x229-11.0-4D
Voltage [V]	3 ~ 400	3 ~ 400	3 ~ 400	3 ~ 400	3 ~ 400	3 ~ 400	3 ~ 400
Frequency [Hz]	50	50	50	50	50	50	50
Power [kW]	5.5	3.0	4.0	11.0	5.5	7.5	11.0
Current [A]	11.0	7.8	9.1	24.0	14.8	17.0	24.0
Maximum air flow [m³/h (l/s)]	10175 (2827)	10230 (2842)	11150 (3097)	19000 (5278)	11550 (3209)	14960 (4156)	17250 (4792)
RPM [min ⁻¹]	1430	700	950	1450	700	955	1450
Sound pressure at 3 m [dBA]	80	70	76	84	72	78	85
Max. transported air temperature [°C]	60	60	60	60	60	60	60
SEC class	-	-	-	-	-	-	-
IP rating	IP54	IP54	IP54	IP54	IP54	IP54	IP54
Motor IP rating	IP54	IP54	IP54	IP54	IP54	IP54	IP54
ErP	-	-	-	-	-	-	-

S-VENT 400x183-2.2-6D, S-VENT 400x183-1.5-8D

Sound power level, A-weighted	Total	Octave frequency bands [Hz]							
		63	125	250	500	1000	2000	4000	8000
S-Vent 400x183-2.2-6D									
LWA to environment [dBA]	75	57	72	75	81	80	81	78	76
S-Vent 400x183-1.5-8D									
LWA to environment [dBA]	68	53	65	69	74	76	77	73	67

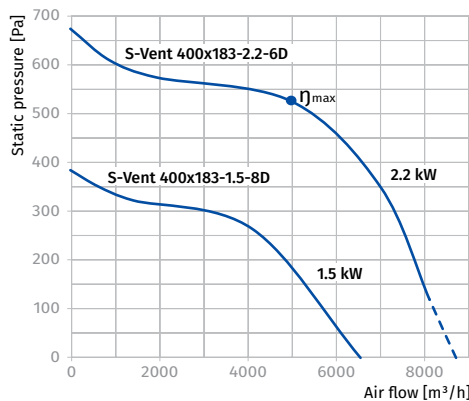

S-VENT 400x183-5.5-4D

Sound power level, A-weighted	Total	Octave frequency bands [Hz]							
		63	125	250	500	1000	2000	4000	8000
LWA to environment [dBA]	75	57	72	75	81	80	81	78	76

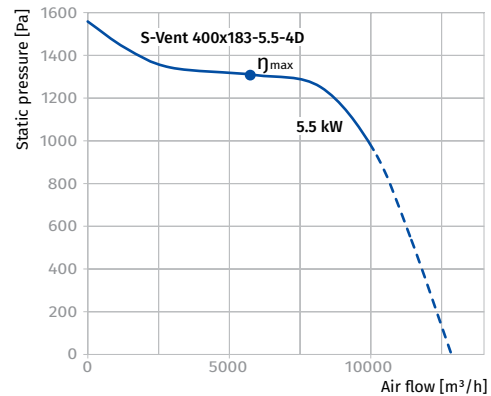

S-VENT 450x203-4.0-6D, S-VENT 450x203-3.0-8D

Sound power level, A-weighted	Total	Octave frequency bands [Hz]							
		63	125	250	500	1000	2000	4000	8000
S-Vent 450x203-4.0-6D									
LWA to environment [dBA]	76	59	74	75	83	83	85	81	77
S-Vent 450x203-3.0-8D									
LWA to environment [dBA]	67	56	63	65	75	75	71	71	69

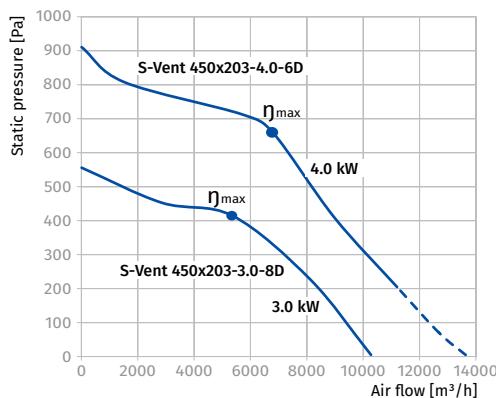

S-VENT 450x203-11.0-4D

Sound power level, A-weighted	Total	Octave frequency bands [Hz]							
		63	125	250	50-0	1000	2000	4000	8000
LWA to environment [dBA]	83	70	84	89	88	94	94	94	91

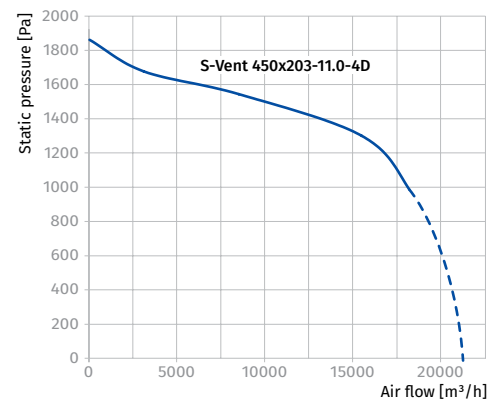

S-VENT 500x229-7.5-6D, S-VENT 500x229-5.5-8D

Sound power level, A-weighted	Total	Octave frequency bands [Hz]							
		63	125	250	500	1000	2000	4000	8000
S-Vent 500x229-7.5-6D									
L _{WA} to environment [dBA]	83	68	79	85	85	93	92	86	85
S-Vent 500x229-5.5-8D									
L _{WA} to environment [dBA]	77	61	74	78	81	86	85	81	80

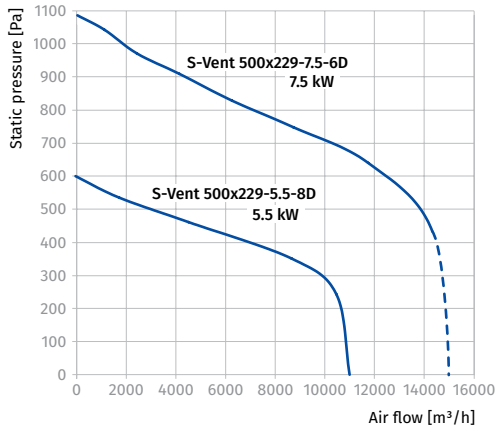

S-VENT 500x229-11.0-4D

Sound power level, A-weighted	Total	Octave frequency bands [Hz]							
		63	125	250	500	1000	2000	4000	8000
L _{WA} to environment [dBA]	85	73	83	90	91	94	97	94	90

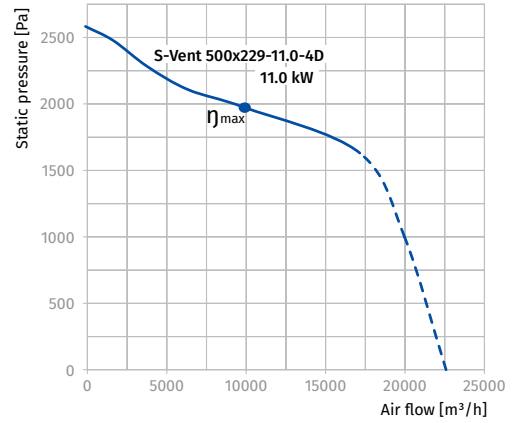

Scroll orientation (view on the intake side)

Right scroll orientation

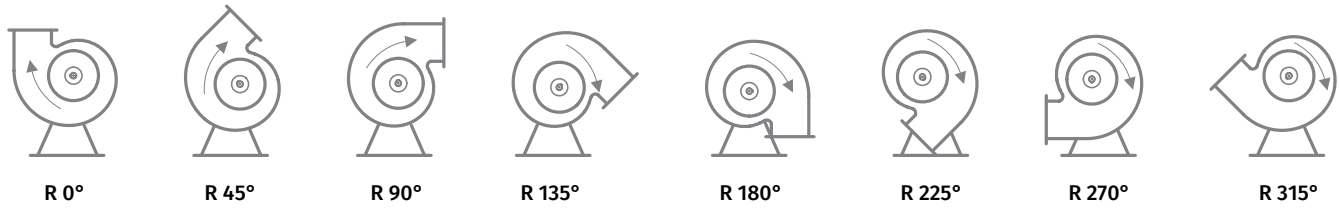

Left scroll orientation

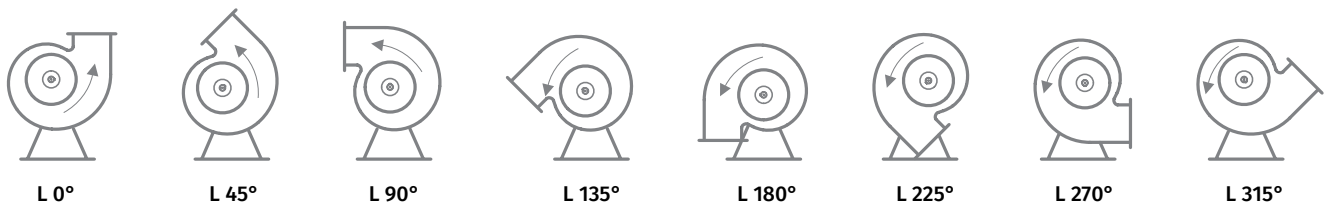

Selection table for accessories

Type	Rubber anti-vibration mounts	Spring-loaded anti-vibration mounts	Flange	Grille
S-Vent 140x74-0.25-4D	SI-G 8	SI-F 8	FRZ-SV 140	SG-SV 140
S-Vent 140x74-0.37-2D	SI-G 8	SI-F 8	FRZ-SV 140	SG-SV 140
S-Vent 160x74-0.55-4D	SI-G 8	SI-F 8	FRZ-SV 160	SG-SV 160
S-Vent 160x74-0.75-2D	SI-G 8	SI-F 8	FRZ-SV 160	SG-SV 160
S-Vent 180x74-0.55-4D	SI-G 8	SI-F 8	FRZ-SV 180	SG-SV 180
S-Vent 180x74-1.1-2D	SI-G 8	SI-F 8	FRZ-SV 180	SG-SV 180
S-Vent 200x93-0.55-4D	SI-G 8	SI-F 8	FRZ-SV 200	SG-SV 200
S-Vent 200x93-1.1-2D	SI-G 8	SI-F 8	FRZ-SV 200	SG-SV 200
S-Vent 225x103-1.1-4D	SI-G 8	SI-F 8	FRZ-SV 225	SG-SV 225
S-Vent 225x103-2.2-2D	SI-G 8	SI-F 8	FRZ-SV 225	SG-SV 225
S-Vent 240x114-2.2-4D	SI-G 16	SI-F 16	FRZ-SV 240	SG-SV 240
S-Vent 240x114-3.0-2D	SI-G 16	SI-F 16	FRZ-SV 240	SG-SV 240
S-Vent 250x127-1.5-6D	SI-G 16	SI-F 16	FRZ-SV 250	SG-SV 250
S-Vent 250x127-2.2-4D	SI-G 16	SI-F 16	FRZ-SV 250	SG-SV 250
S-Vent 250x127-5.5-2D	SI-G 16	SI-F 16	FRZ-SV 250	SG-SV 250
S-Vent 280x127-1.5-6D	SI-G 16	SI-F 16	FRZ-SV 280	SG-SV 280
S-Vent 280x127-2.2-4D	SI-G 16	SI-F 16	FRZ-SV 280	SG-SV 280
S-Vent 280x127-5.5-2D	SI-G 16	SI-F 16	FRZ-SV 280	SG-SV 280
S-Vent 315x143-2.2-6D	SI-G 26	SI-F 26	FRZ-SV 315	SG-SV 315
S-Vent 315x143-4.0-4D	SI-G 26	SI-F 26	FRZ-SV 315	SG-SV 315
S-Vent 355x143-2.2-6D	SI-G 26	SI-F 26	FRZ-SV 355	SG-SV 355
S-Vent 355x143-4.0-4D	SI-G 26	SI-F 26	FRZ-SV 355	SG-SV 355
S-Vent 400x183-1.5-8D	SI-G 35	SI-F 35	FRZ-SV 400	SG-SV 400
S-Vent 400x183-2.2-6D	SI-G 35	SI-F 35	FRZ-SV 400	SG-SV 400
S-Vent 400x183-5.5-4D	SI-G 35	SI-F 35	FRZ-SV 400	SG-SV 400
S-Vent 450x203-3.0-8D	SI-G 50	SI-F 50	FRZ-SV 450	SG-SV 450
S-Vent 450x203-4.0-6D	SI-G 50	SI-F 50	FRZ-SV 450	SG-SV 450
S-Vent 450x203-11.0-4D	SI-G 50	SI-F 50	FRZ-SV 450	SG-SV 450
S-Vent 500x229-5.5-8D	SI-G 75	SI-F 75	FRZ-SV 500	SG-SV 500
S-Vent 500x229-7.5-6D	SI-G 75	SI-F 75	FRZ-SV 500	SG-SV 500
S-Vent 500x229-11.0-4D	SI-G 75	SI-F 75	FRZ-SV 500	SG-SV 500