

Tower-H

Roof centrifugal fans

Use

- Extract ventilation systems installed in various premises.
- Roof mounting.
- For any types of roofs or vertical ventilation shafts.



Air flow:
up to 17 010 m³/h
4725 l/s



Power:
from 48 W



Noise level:
from 45 dBA



Design

- Steel casing with a special polymer atmospheric resistant coating.
- Horizontal air exhaust.
- The fan is equipped with a terminal block for connection to power mains.
- The fan is rated for continuous operation.
- Impeller with a protecting insect screen.
- The upper cover is equipped with two eye bolts for easy fan lifting on the roof with hoisting mechanism.
- A connecting plate with an intake opening is designed to facilitate mounting to the roof surface.

Motor

- Two-, four- or six-pole asynchronous motor with external rotor and centrifugal impeller with backward curved blades.
- Single-phase (E) or three-phase (D) motor modifications.
- Dynamically balanced impeller.
- Equipped with ball bearings for longer service life.
- Overheating protection by built-in thermal switches with leaded outside terminals for connection to external protecting controls.
- The thermal switch terminal leads are designed for connection to respective circuit of the overload relay or respective terminals of the auto-transformer or thyristor speed controller.

Speed control

- Smooth or step speed control with a thyristor or transformer speed controller (available upon order).

Mounting

- Roof mounting directly above a ventilation shaft or air duct.
- The fan is connected to the air duct with the intake flange that is fixed to the fan base.
- The fan base has holes for fixing bolts that attach the fan to the stable level surface or a roof frame.
- Roof frame and intake flange available on separate order.
- Power is supplied through an external terminal box.

Designation key

Series	Impeller standard size	Motor Number of poles	Phase	Casing material
Tower-H	220; 225; 250; 280; 310; 355; 400; 450; 500	2; 4; 6	E: single-phase D: three-phase	_: steel with polymeric coating A: aluminum

Accessories

Flexible connectors for roof fans	Counterflanges	Mounting frames	Silencers	Backdraft air dampers	Air dampers	Speed controllers
 VDL	 FDL	 MRDL / MRIDL	 SD	 VRV	 VK / VKA	 CDT E1.8

Overall dimensions [mm]

Type	∅D	H	H1	L	L1	Weight [kg]
Tower-H 190 2E	213	189	195	351	350	8.2
Tower-H 220 2E	213	180	186	337	338	7
Tower-H 225 2E	210	210	217	351	350	9.2
Tower-H 225 4E	210	233	240	351	350	8.8
Tower-H 250 2E	285	237	244	451	450	12.7
Tower-H 250 4E	285	237	244	451	450	12.1
Tower-H 280 4E	291	265	272	451	450	13.5
Tower-H 310 2E	291	251	258	451	450	13.2
Tower-H 310 4E	285	287	294	451	450	14.2
Tower-H 310 4D	285	287	294	451	450	14.2
Tower-H 355 4E	438	322	361	625	620	28.3
Tower-H 355 4D	438	347	386	625	620	30.3
Tower-H 400 4E	438	376	415	625	620	35
Tower-H 400 6E	438	376	415	625	620	32.7
Tower-H 400 4D	438	376	415	625	620	35
Tower-H 450 4E	438	420	459	710	700	46.6
Tower-H 450 6E	438	420	459	710	700	45.6
Tower-H 450 4D	438	420	459	710	700	45.5
Tower-H 500 6E	445	461	501	710	700	52.8
Tower-H 500 4D	430	490	530	710	700	46.6
Tower-H 500 6D	445	461	501	710	700	52.7
Tower-H 560 6E	605	489	528	900	895	76.4
Tower-H 560 4D	605	489	528	900	895	81.4
Tower-H 560 6D	605	489	528	900	895	76.4
Tower-H 630 6D	600	520	560	1000	990	96.3
Tower-H 710 6D	674	570	619	1060	1050	134

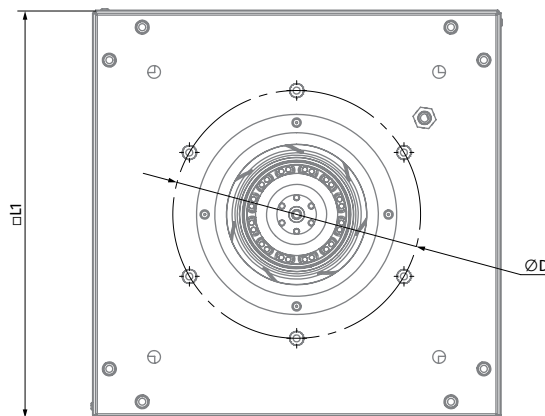
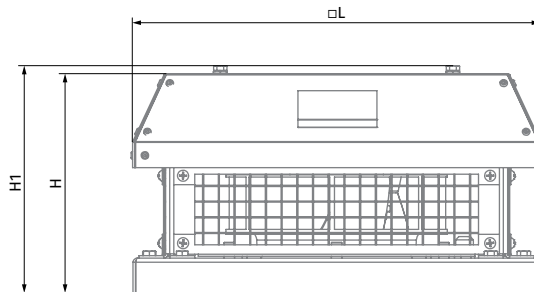

Technical data

Parameters	Tower-H 190 2E		Tower-H 220 2E		Tower-H 225 2E		Tower-H 225 4E	
Voltage [V]	1~230		1~230		1~230		1~230	
Frequency [Hz]	50	60	50	60	50	60	50	
Power [W]	69	89	108	118	123	169	49	
Current [A]	0.30	0.40	0.49	0.54	0.54	0.70	0.22	
Maximum air flow [m ³ /h (l/s)]	610 (169)	654 (182)	880 (244)	883 (245)	915 (254)	1010 (281)	738 (205)	
RPM [min ⁻¹]	2680	2980	2580	2840	2790	2820	1400	
Sound pressure at 3 m [dBA]	48	49	50	51	51	52	45	
Max. transported air temperature [°C]	-25...+50		-25...+50		-25...+50		-25...+50	
SEC class	C	-	C	-	C	-	C	
IP rating	IPX4		IPX4		IPX4		IPX4	
Motor IP rating	IP44		IP44		IP44		IP44	
ErP	2018	-	2018	-	2018	-	2018	

TOWER-H 190 2E

Sound power level, A-weighted	Total	Octave frequency bands [Hz]								LpA 3 m	LpA 1 m
		63	125	250	500	1000	2000	4000	8000		
LWA to inlet [dBA]	68	39	65	63	54	52	49	49	39	47	57
LWA to environment [dBA]	69	28	50	61	64	63	62	54	41	48	58

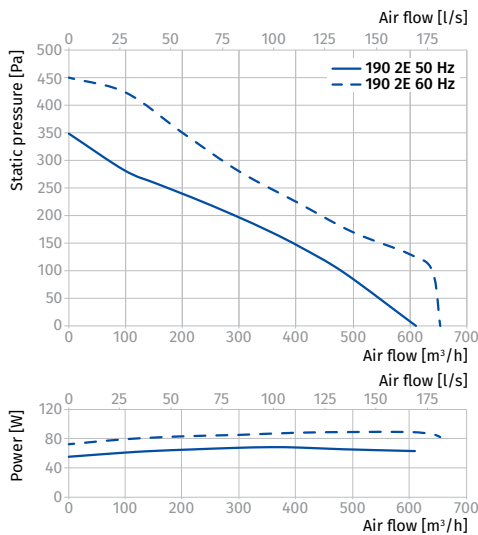
TOWER-H 220 2E

Sound power level, A-weighted	Total	Octave frequency bands [Hz]								LpA 3 m	LpA 1 m
		63	125	250	500	1000	2000	4000	8000		
LWA to inlet [dBA]	70	59	65	65	61	55	55	54	47	49	59
LWA to environment [dBA]	71	46	58	66	65	66	56	51	41	50	60

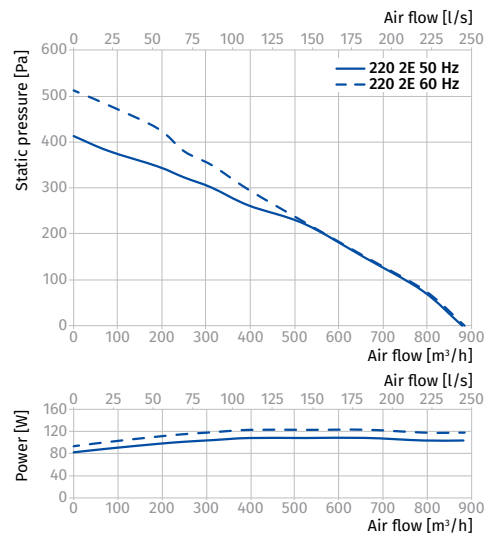
TOWER-H 225 2E

Sound power level, A-weighted	Total	Octave frequency bands [Hz]								LpA 3 m	LpA 1 m
		63	125	250	500	1000	2000	4000	8000		
LWA to inlet [dBA]	71	61	66	66	62	57	57	55	48	51	61
LWA to environment [dBA]	72	47	59	67	66	67	57	52	42	51	61

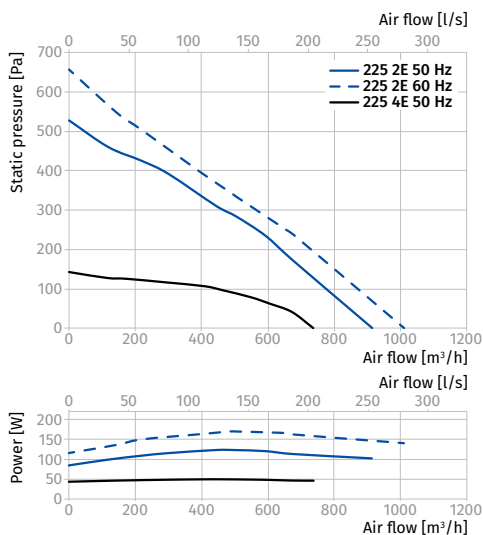

Parameters	Tower-H 250 2E		Tower-H 250 4E	Tower-H 280 4E	
Voltage [V]	1~230		1~230	1~230	
Frequency [Hz]	50	60	50	50	60
Power [W]	184	232	48	125	155
Current [A]	0.81	0.90	0.23	0.61	0.99
Maximum air flow [m³/h (l/s)]	1450 (403)	1320 (367)	820 (228)	1490 (414)	1520 (422)
RPM [min⁻¹]	2480	2320	1440	1446	1710
Sound pressure at 3 m [dBA]	54	53	46	46	46
Max. transported air temperature [°C]	-25...+50		-25...+50	-25...+50	
SEC class	-		-	-	
IP rating	IPX4		IPX4	IPX4	
Motor IP rating	IP44		IP44	IP44	
ErP	2018	-	2018	2018	-

TOWER-H 250 2E, TOWER-H 250 4E

Sound power level, A-weighted	Total	Octave frequency bands [Hz]								LpA 3 m	LpA 1 m
		63	125	250	500	1000	2000	4000	8000		
Tower-H 250 2E											
LWA to inlet [dBA]	75	50	63	70	68	69	66	63	53	54	64
LWA to environment [dBA]	75	51	64	71	67	67	66	62	56	54	64
Tower-H 250 4E											
LWA to inlet [dBA]	68	51	57	60	52	63	62	57	52	47	57
LWA to environment [dBA]	67	29	48	57	60	63	59	51	37	46	56

TOWER-H 280 4E

Sound power level, A-weighted	Total	Octave frequency bands [Hz]								LpA 3 m	LpA 1 m
		63	125	250	500	1000	2000	4000	8000		
LWA to inlet [dBA]	66	46	55	53	59	60	59	55	45	45	55
LWA to environment [dBA]	67	29	48	57	60	63	59	51	37	46	56

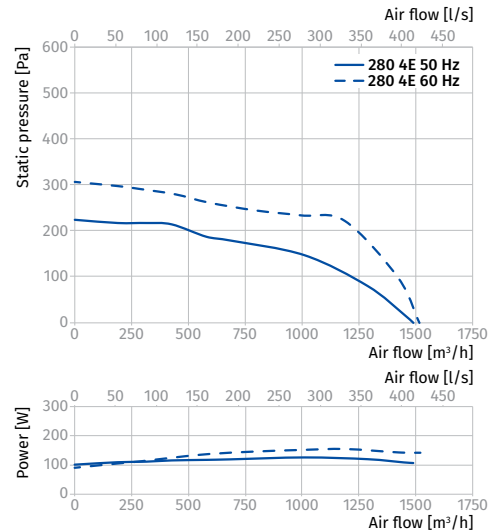
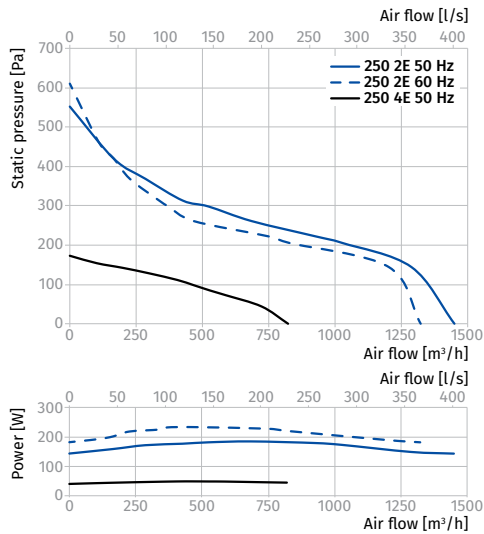

ROOF FANS

Parameters	Tower-H 310 2E	Tower-H 310 4E		Tower-H 310 4D		Tower-H 355 4E		Tower-H 355 4D	
Voltage [V]	1~230	1~230		3~400		1~230		3~400	
Frequency [Hz]	50	50	60	50	60	50	60	50	60
Power [W]	324	141	195	155	202	219	304	264	330
Current [A]	1.42	0.64	0.87	0.29	0.32	0.96	1.33	0.58	0.64
Maximum air flow [m³/h (l/s)]	2150 (597)	2265 (629)	2425 (674)	2300 (639)	2442 (678)	2480 (689)	2976 (827)	3290 (914)	3540 (983)
RPM [min⁻¹]	2620	1420	1740	1410	1550	1420	1580	1430	1650
Sound pressure at 3 m [dBA]	58	47	49	47	48	51	52	52	53
Max. transported air temperature [°C]	-25...+50	-25...+50		-25...+50		-25...+50		-30...+60	
IP rating	IPX4	IPX4		IPX4		IPX4		IPX4	
Motor IP rating	IP44	IP54		IP54		IP54		IP54	
ErP	2018	2018	-	2018	-	2018	-	2018	-

TOWER-H 310 2E, TOWER-H 310 4E, TOWER-H 310 4D

Sound power level, A-weighted	Total	Octave frequency bands [Hz]								LpA 3 m	LpA 1 m
		63	125	250	500	1000	2000	4000	8000		
Tower-H 310 2E											
LWA to inlet [dBA]	76	47	48	56	69	71	71	69	59	56	66
LWA to environment [dBA]	79	40	48	62	73	74	74	66	49	58	68
Tower-H 310 4E											
LWA to inlet [dBA]	67	47	56	54	61	62	61	57	47	47	57
LWA to environment [dBA]	68	30	49	58	61	65	60	52	38	47	57
Tower-H 310 4D											
LWA to inlet [dBA]	67	46	53	56	62	63	58	55	43	47	57
LWA to environment [dBA]	67	55	59	56	58	63	58	58	39	47	57

TOWER-H 355 4E, TOWER-H 355 4D

Sound power level, A-weighted	Total	Octave frequency bands [Hz]								LpA 3 m	LpA 1 m
		63	125	250	500	1000	2000	4000	8000		
Tower-H 355 4E											
LWA to inlet [dBA]	69	42	43	50	62	64	64	62	53	49	59
LWA to environment [dBA]	72	36	43	56	66	67	67	60	44	51	61
Tower-H 355 4D											
LWA to inlet [dBA]	71	43	44	52	63	66	66	64	54	50	60
LWA to environment [dBA]	73	36	44	57	67	68	68	60	45	52	62

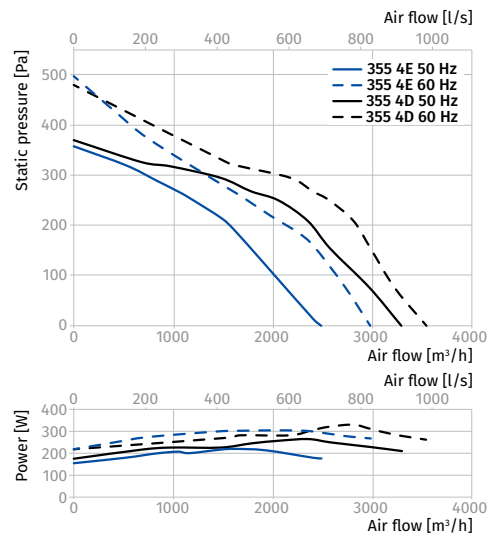
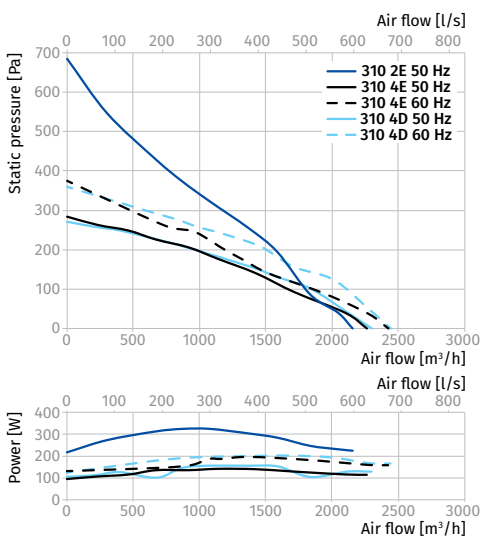

Parameters	Tower-H 400 4E	Tower-H 400 6E		Tower-H 400 4D	Tower-H 450 4E	Tower-H 450 6E	Tower-H 450 4D
Voltage [V]	1~230	1~230		3~400	1~230	1~230	3~400
Frequency [Hz]	50	50	60	50	50	50	50
Power [W]	457	184	249	420	749	268	755
Current [A]	2.00	0.89	1.10	0.99	3.35	1.25	1.50
Maximum air flow [m³/h (l/s)]	3950 (1097)	2740 (761)	3289 (914)	3950 (1097)	6180 (1717)	4380 (1217)	5920 (1644)
RPM [min⁻¹]	1440	945	1071	1440	1400	940	1440
Sound pressure at 3 m [dBA]	55	47	49	55	58	50	57
Max. transported air temperature [°C]	-30...+60	-30...+60		-30...+60	-30...+60	-30...+60	-30...+50
IP rating	IPX4	IPX4		IPX4	IPX4	IPX4	IPX4
Motor IP rating	IP54	IP54		IP54	IP54	IP54	IP54
ErP	2018	2018	-	2018	2018	2018	2018

TOWER-H 400 4E, TOWER-H 400 4D, TOWER-H 400 6E

Sound power level, A-weighted	Total	Octave frequency bands [Hz]								LpA 3 m	LpA 1 m
		63	125	250	500	1000	2000	4000	8000		
Tower-H 400 4E											
LWA to inlet [dBA]	75	46	47	55	67	70	70	68	57	54	64
LWA to environment [dBA]	76	38	46	59	70	71	71	63	47	55	65
Tower-H 400 4D											
LWA to inlet [dBA]	75	44	73	70	60	58	55	54	43	54	64
LWA to environment [dBA]	76	30	56	68	71	70	69	60	46	55	65
Tower-H 400 6E											
LWA to inlet [dBA]	65	44	51	54	60	61	56	52	41	45	55
LWA to environment [dBA]	67	55	59	56	58	63	58	58	39	47	57

TOWER-H 450 4E, TOWER-H 450 4D, TOWER-H 450 6E

Sound power level, A-weighted	Total	Octave frequency bands [Hz]								LpA 3 m	LpA 1 m
		63	125	250	500	1000	2000	4000	8000		
Tower-H 450 4E											
LWA to inlet [dBA]	78	45	75	73	62	60	57	56	45	57	67
LWA to environment [dBA]	78	31	58	70	74	73	71	62	47	58	68
Tower-H 450 4D											
LWA to inlet [dBA]	77	45	74	72	61	60	56	55	45	56	66
LWA to environment [dBA]	77	31	57	69	73	71	70	61	46	57	67
Tower-H 450 6E											
LWA to inlet [dBA]	68	46	54	57	63	64	59	55	43	48	58
LWA to environment [dBA]	70	58	62	59	61	66	60	61	41	50	60

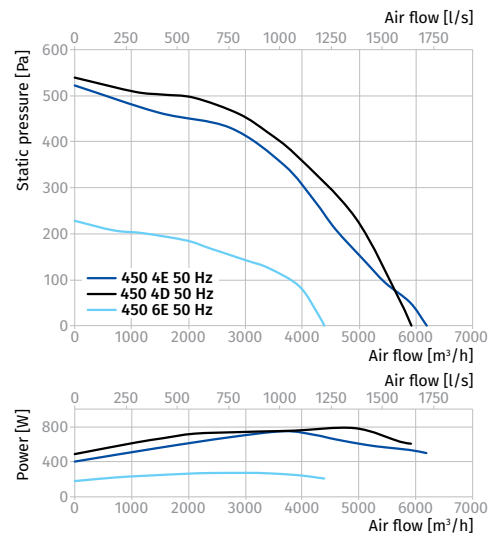
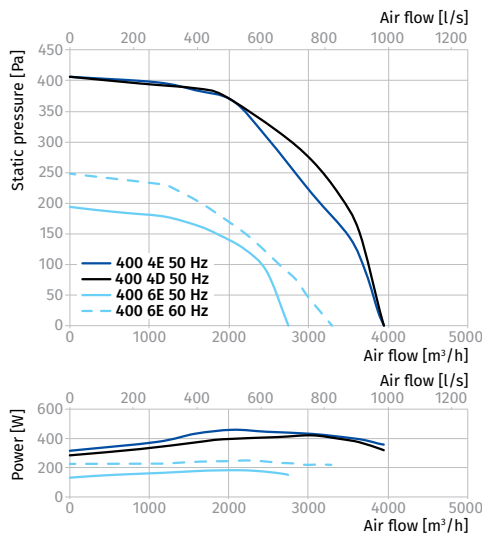

Parameters	Tower-H 500 4D	Tower-H 500 6E		Tower-H 500 6D		Tower-H 560 4D	Tower-H 560 6E	Tower-H 560 6D
Voltage [V]	3~400	1~230		3~400		3~400	1~230	3~400
Frequency [Hz]	50	50	60	50	60	50	50	50
Power [W]	1527	407	673	440	599	1970	613	696
Current [A]	2.64	1.81	3.05	1.23	1.32	3.36	2.70	1.44
Maximum air flow [m³/h (l/s)]	8435 (2343)	5680 (1578)	6532 (1814)	6000 (1667)	6122 (1701)	13 560 (3767)	9560 (2656)	9630 (2675)
RPM [min ⁻¹]	1460	970	1120	978	1125	1400	930	970
Sound pressure at 3 m [dBA]	62	52	54	52	54	66	58	58
Max. transported air temperature [°C]	-30...+50	-25...+60		-25...+60		-25...+50	-25...+50	-25...+50
IP rating	IPX4	IPX4		IPX4		IPX4	IPX4	IPX4
Motor IP rating	IP54	IP54		IP54		IP54	IP54	IP54
ErP	2018	2018	-	2018	-	2018	2018	2018

TOWER-H 500 4D, TOWER-H 500 6E, TOWER-H 500 6D

Sound power level, A-weighted	Total	Octave frequency bands [Hz]								LpA 3 m	LpA 1 m
		63	125	250	500	1000	2000	4000	8000		
Tower-H 500 4D											
LWA to inlet [dBA]	82	48	80	77	65	64	60	59	48	61	71
LWA to environment [dBA]	83	33	61	74	78	77	76	65	50	62	72
Tower-H 500 6E											
LWA to inlet [dBA]	70	48	56	59	66	66	61	57	45	50	60
LWA to environment [dBA]	72	60	64	60	63	68	62	63	42	52	62
Tower-H 500 6D											
LWA to inlet [dBA]	70	48	55	58	65	66	61	57	44	49	59
LWA to environment [dBA]	72	60	64	60	63	68	62	63	42	52	62

TOWER-H 560 4D, TOWER-H 560 6E, TOWER-H 560 6D

Sound power level, A-weighted	Total	Octave frequency bands [Hz]								LpA 3 m	LpA 1 m
		63	125	250	500	1000	2000	4000	8000		
Tower-H 560 4D											
LWA to inlet [dBA]	85	50	83	80	68	66	62	61	49	64	74
LWA to environment [dBA]	87	35	65	78	82	81	80	69	53	66	76
Tower-H 560 6E											
LWA to inlet [dBA]	77	64	69	71	70	67	67	66	59	56	66
LWA to environment [dBA]	79	52	65	74	73	74	63	57	46	58	68
Tower-H 560 6D											
LWA to inlet [dBA]	77	65	70	71	71	68	68	67	59	57	67
LWA to environment [dBA]	79	52	65	74	73	74	63	57	46	58	68

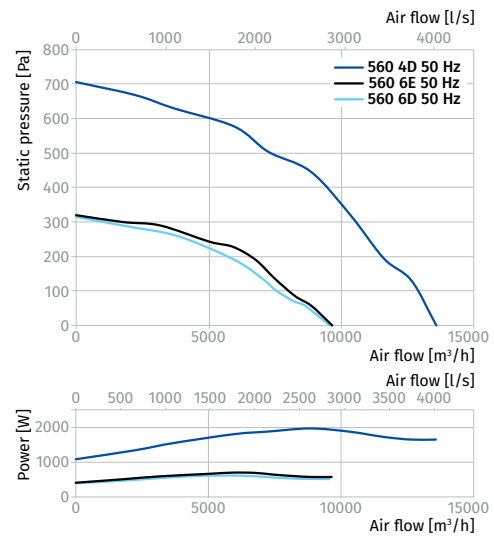
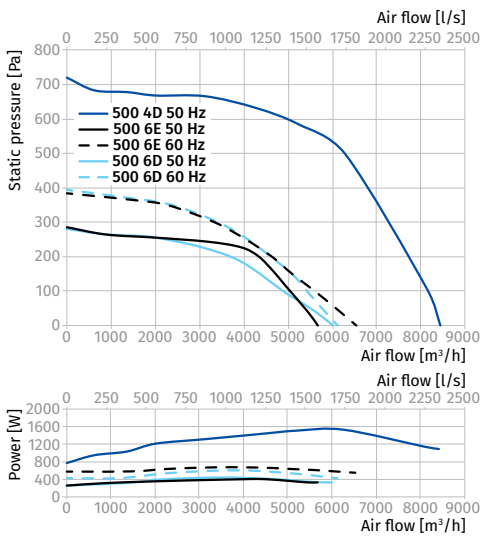

Parameters	Tower-H 630 6D	Tower-H 710 6D
Voltage [V]	3~400	3~400
Frequency [Hz]	50	50
Power [W]	1110	2583
Current [A]	2.42	4.87
Maximum air flow [m³/h (l/s)]	12 640 (3511)	17 010 (4725)
RPM [min ⁻¹]	957	945
Sound pressure at 3 m [dBA]	64	67
Max. transported air temperature [°C]	-25...+50	-25...+70
IP rating	IPX4	IPX4
Motor IP rating	IP54	IP54
ErP	2018	2018

TOWER-H 630 6D

Sound power level, A-weighted	Total	Octave frequency bands [Hz]								LpA 3 m	LpA 1 m
		63	125	250	500	1000	2000	4000	8000		
LWA to inlet [dBA]	82	69	74	76	75	72	72	71	63	61	71
LWA to environment [dBA]	85	56	70	80	79	80	68	62	50	64	74

TOWER-H 710 6D

Sound power level, A-weighted	Total	Octave frequency bands [Hz]								LpA 3 m	LpA 1 m
		63	125	250	500	1000	2000	4000	8000		
LWA to inlet [dBA]	85	72	78	80	79	76	76	75	66	65	75
LWA to environment [dBA]	88	58	73	83	82	83	71	64	52	67	77

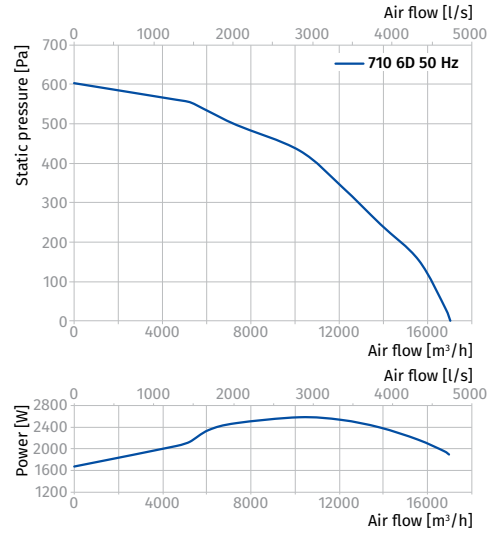
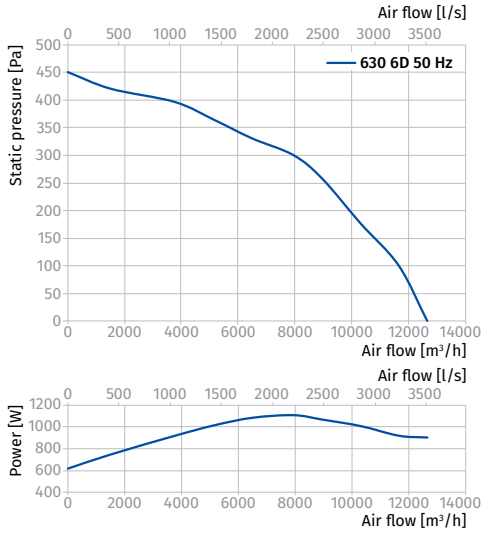

ROOF FANS